



Electric Automation
Automation specialists

Reference: GRM 55 200 G
Code: 6001446

Mesh cable tray GRM , 55x200x3000,
Electrogalvanised, DIN 50961, Steel, St

Buy it at [Electric Automation Network](#)

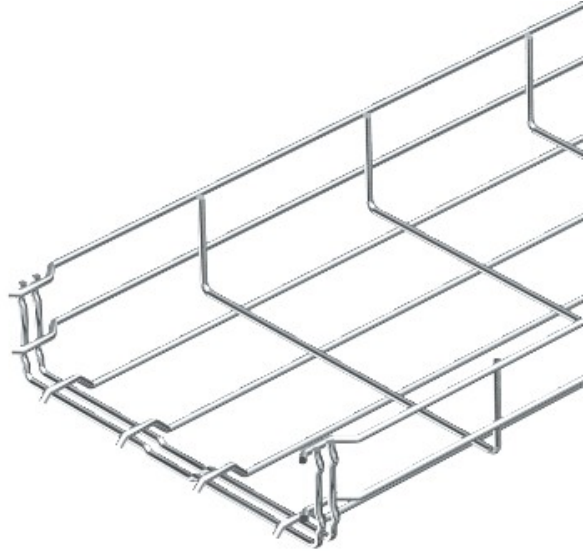

Magnetic shield insulation without cover 15 dB, with cover 25 dB. You can find detailed information regarding the UL classification in the respective certification.