



Electric Automation
Automation specialists

Reference: GRM 35 300 FT

Code: 6000075

Mesh cable tray GRM , 35x300x3000,
Hot-dip galvanised, DIN EN ISO 1461,
Steel, St

[Buy it at Electric Automation Network](#)

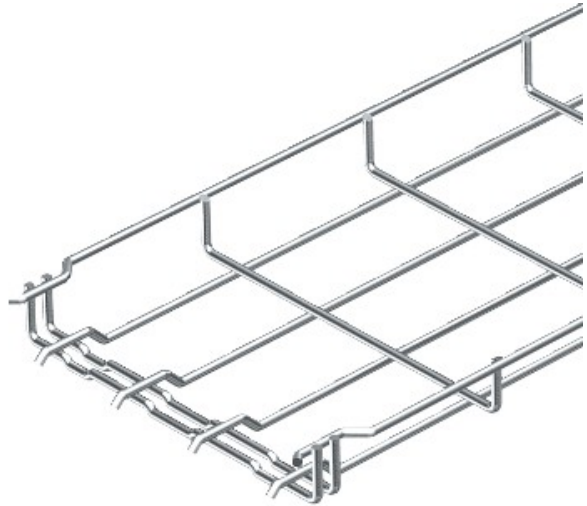

Magnetic shield insulation without cover 15 dB, with cover 25 dB.