



Electric Automation
Automation specialists

Reference: GRM 35 100 G
Code: 6000062

Mesh cable tray GRM , 35x100x3000,
Electrogalvanised, DIN 50961, Steel, St

[Buy it at Electric Automation Network](#)

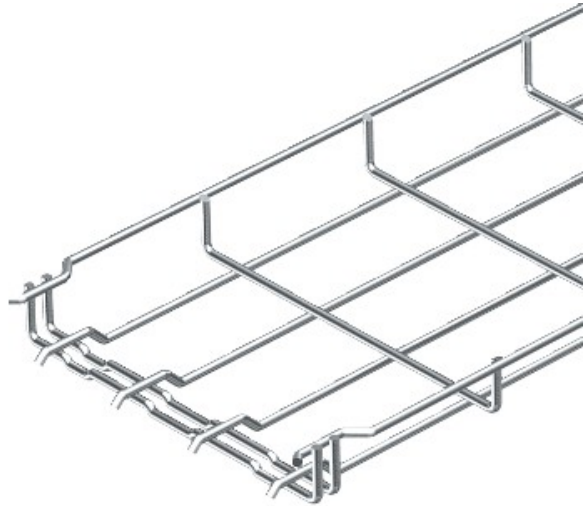

Magnetic shield insulation without cover 15 dB, with cover 25 dB.