



Electric Automation
Automation specialists

Reference: 2056N M 34 FT
Code: 1155458

Clamp clip with metal pressure sump,
28-34mm, Hot-dip galvanised, DIN EN
ISO 1461, Steel, St

Buy it at [Electric Automation Network](#)

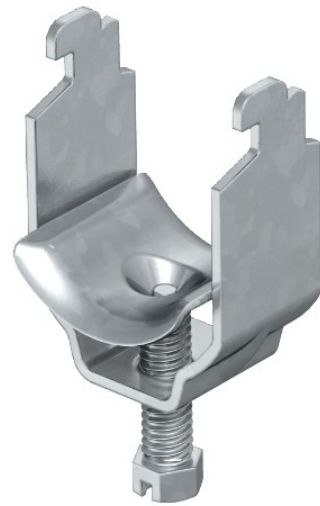

Suitable for all C profile rails with slot width >