



Electric Automation
Automation specialists

Reference: 2056N M 28 FT
Code: 1155431

Clamp clip with metal pressure sump,
22-28mm, Hot-dip galvanised, DIN EN
ISO 1461, Steel, St

Buy it at [Electric Automation Network](#)

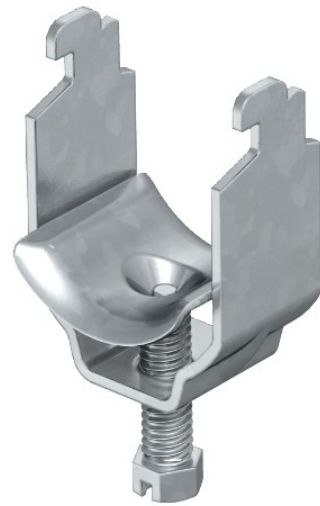

Suitable for all C profile rails with slot width >