



Electric Automation
Automation specialists

Reference: 2056N M 12 FT
Code: 1155407

Clamp clip with metal pressure sump,
8-12mm, Hot-dip galvanised, DIN EN ISO
1461, Steel, St

Buy it at [Electric Automation Network](#)

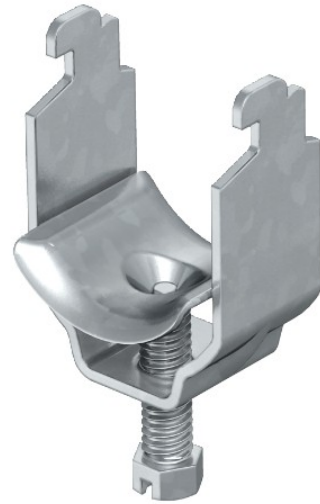

Suitable for all C profile rails with slot width >