



**Electric Automation**  
Automation specialists

Reference: OKA-G50040150FBR  
Code: 7423976

Branch, right for OKA-G and OKA-W,  
Strip-galvanised, DIN EN 10147, Steel, St

Buy it at [Electric Automation Network](#)

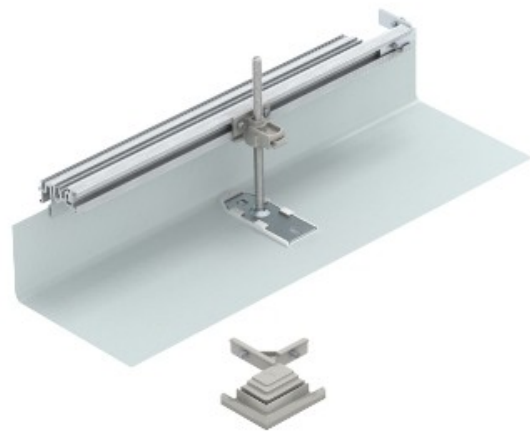

For construction-side creation of a trunking junction as a 90° angle to the right. With all the parts necessary for mounting. Suitable for the OKA-G and OKA-W trunking systems.