



Electric Automation
Automation specialists

Reference: OKA-G40040150FBL
Code: 7423954

Branch, left for OKA-G and OKA-W, Strip-galvanised, DIN EN 10147, Steel, St

Buy it at [Electric Automation Network](#)

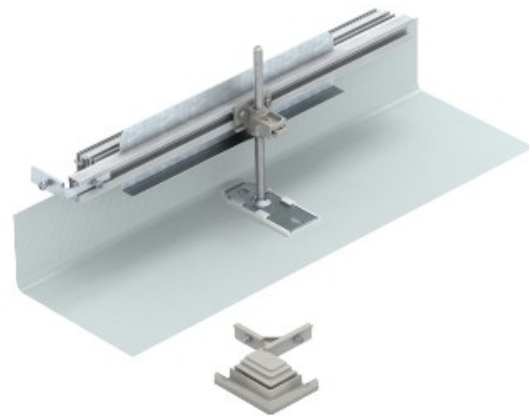

For construction-side creation of a trunking junction as a 90° angle to the left. With all the parts necessary for mounting. Suitable for the OKA-G and OKA-W trunking systems.