



## Circuit-breaker, 3p, 100A

**Part no.** NZMH2-M100  
**Article no.** 281306

Similar to illustration

## Delivery programme

Product range				Circuit-breaker
Protective function				Motor protection
Standard/Approval				IEC
Installation type				Fixed
Release system				Thermomagnetic release
Construction size				NZM2
Description				Tripping class 10 A IEC/EN 60947-4-1, IEC/EN 60947-2  The circuit-breaker fulfills all requirements for AC-3 switching category.
Number of poles				3 pole
Standard equipment				Screw connection
<b>Switching capacity</b>				
400/415 V 50/60 Hz	$I_{cu}$	kA		150
Rated current = rated uninterrupted current	$I_n = I_u$	A		100
<b>Setting range</b>				
Overload trip				
	$I_r$	A		80 - 100
<b>Motor rating AC-3 50/60 Hz</b>				
380 V 400 V	P	kW		45
<b>Motor rating AC-3 50/60 Hz</b>				
400 V	P	kW		45
<b>Rated operational current AC-3 50/60 Hz</b>				
400 V	$I_e$	A		99

## Technical data

### General

Standards				IEC/EN 60947
Protection against direct contact				Finger and back of hand proof to VDE 0106 Part 100
Climatic proofing				Damp heat, constant, to IEC 60068-2-78 Damp heat, cyclic, to IEC 60068-2-30
Ambient temperature				
Ambient temperature, storage		°C		- 40 - + 80
Operation		°C		-25 - +70
Mechanical shock resistance (10 ms half-sinusoidal shock) according to IEC 60068-2-27		g		20 (half-sinusoidal shock 20 ms)
Safe isolation to EN 61140				
Between auxiliary contacts and main contacts		V AC		500
between the auxiliary contacts		V AC		300
Weight		kg		2.345
Mounting position				Vertical and 90° in all directions



With residual-current release XFI:

- NZM1, N1, NZM2, N2: vertical and 90° in all directions
- with plug-in adapter elements
- NZM1, N1, NZM2, N2: vertical, 90° right/left
- with withdrawable unit:
- NZM3, N3: vertical, 90° left
- NZM4, N4: vertical
- with remote operator:
- NZM2, N(S)2, NZM3, N(S)3, NZM4, N(S)4: vertical and 90° in all directions

Direction of incoming supply		as required
Degree of protection		
Device		In the operating controls area: IP20 (basic degree of protection)
Enclosures		With insulating surround: IP40 With door coupling rotary handle: IP66
Terminations		Tunnel terminal: IP10 Phase isolator and strip terminal: IP00
Other technical data (sheet catalogue)		Weight Temperature dependency, Derating Effective power loss

### Circuit-breakers

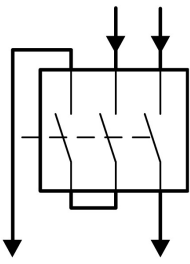
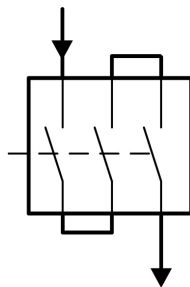
Rated current – rated uninterrupted current	$I_n = I_u$	A	100
Rated surge voltage invariability	$U_{imp}$		
Main contacts		V	8000
Auxiliary contacts		V	6000
Rated operational voltage	$U_e$	V AC	690
			<p>1) Details apply for 3 pole system protection circuit-breaker with thermomagnetic release NZMN(H)1(2)(3)-A... to 500 A.</p> <p>For rated operating voltage switching via 3 contacts:</p> <p>DC correction factor for instantaneous release response value: NZM1: 1.25, NZM2: 1.35, NZM3: 1.45</p> <p>Set value for <math>I_i</math> at DC = set value <math>I_i</math> AC/correction factor DC</p> <p><b>Switching of one pole via two series contacts</b></p>  <p><b>Switching of one pole via three series contacts</b></p> 
Overvoltage category/pollution degree			III/3
Rated insulation voltage	$U_i$	V	1000
Use in unearthed supply systems		V	≦ 690

### Switching capacity

Rated short-circuit making capacity	$I_{cm}$		
240 V	$I_{cm}$	kA	330
400/415 V	$I_{cm}$	kA	330
440 V 50/60 Hz	$I_{cm}$	kA	286
525 V 50/60 Hz	$I_{cm}$	kA	105
690 V 50/60 H	$I_c$	kA	40
Rated short-circuit breaking capacity $I_{cn}$	$I_{cn}$		
$I_{cu}$ to IEC/EN 60947 test cycle O-t-CO	$I_{cu}$	kA	
240 V 50/60 Hz	$I_{cu}$	kA	150
400/415 V 50/60 Hz	$I_{cu}$	kA	150
440 V 50/60 Hz	$I_{cu}$	kA	130

525 V 50/60 Hz	I <sub>CU</sub>	kA	50
I <sub>CS</sub> to IEC/EN 60947 test cycle O-t-CO-t-CO	I <sub>CS</sub>	kA	
240 V 50/60 Hz	I <sub>CS</sub>	kA	150
400/415 V 50/60 Hz	I <sub>CS</sub>	kA	150
440 V 50/60 Hz	I <sub>CS</sub>	kA	130
525 V 50/60 Hz	I <sub>CS</sub>	kA	37.5
690 V 50/60 Hz	I <sub>CS</sub>	kA	5
			Maximum back-up fuse, if the expected short-circuit currents at the installation location exceed the switching capacity of the circuit-breaker.
Rated short-time withstand current			
t = 0.3 s	I <sub>CW</sub>	kA	1.9
t = 1 s	I <sub>CW</sub>	kA	1.9
Utilization category to IEC/EN 60947-2			A
Rated making and breaking capacity			
Rated operational current	I <sub>e</sub>	A	
AC-1			
380 V 400 V	I <sub>e</sub>	A	100
415 V	I <sub>e</sub>	A	100
690 V	I <sub>e</sub>	A	100
AC--3			
380 V 400 V	I <sub>e</sub>	A	81
415 V	I <sub>e</sub>	A	81
Lifespan, mechanical(of which max. 50 % trip by shunt/undervoltage release)	Operations		20000
Lifespan, electrical			
AC-1			
400 V 50/60 Hz	Operations		10000
415 V 50/60 Hz	Operations		10000
690 V 50/60 Hz	Operations		7500
AC--3			
400 V 50/60 Hz	Operations		6500
415 V 50/60 Hz	Operations		6500
690 V 50/60 Hz	Operations		5000
Max. operating frequency		Ops/h	120
Current heat losses per pole at I <sub>U</sub> are based on the maximum rated operational current of the frame size.		W	19
			For current heat loss per pole the specification refers to the maximum rated operational current of the frame size.
Total downtime in a short-circuit		ms	< 10

## Terminal capacity

Standard equipment			Screw connection
Overview			Basic equipment
			Box terminal
			Screw connection
			Accessories
			Box terminal
			Screw connection
			Tunnel terminal
			Connection on rear
			Flat conductor terminal
Round copper conductor			
Box terminal			
Solid		mm <sup>2</sup>	1 x (10 - 16) 2 x (6-16)

Stranded		mm <sup>2</sup>	1 x (25 - 185) 2 x (25 - 70)
Tunnel terminal			
Solid		mm <sup>2</sup>	1 x 16
Stranded		mm <sup>2</sup>	
Stranded		mm <sup>2</sup>	1 x (25 - 185)
Bolt terminal and rear-side connection			
Direct on the switch			
Solid		mm <sup>2</sup>	1 x (10 - 16) 2 x (10 - 16)
Stranded		mm <sup>2</sup>	1 x (25 - 50) 2 x (25 - 50)
Al conductors, Cu cable			
Solid		mm <sup>2</sup>	1 x 16
Stranded		mm <sup>2</sup>	
Stranded		mm <sup>2</sup>	1 x (25 - 185)
Bolt terminal and rear-side connection			
Flat copper strip, with holes	min.	mm	2 x 16 x 0.8
Flat copper strip, with holes	max.	mm	10 x 24 x 0.8
Cu strip (number of segments x width x segment thickness)			
Box terminal			
	min.	mm	2 x 9 x 0.8
	max.	mm	10 x 16 x 0.8 (2x) 8 x 15.5 x 0,8
Bolt terminal and rear-side connection			
Flat copper strip, with holes	min.	mm	2 x 16 x 0.8
Flat copper strip, with holes	max.	mm	10 x 24 x 0.8
Copper busbar (width x thickness)	mm		
Bolt terminal and rear-side connection			
Screw connection			M8
Direct on the switch			
	min.	mm	16 x 5
	max.	mm	24 x 8
Control cables			
		mm <sup>2</sup>	1 x (0.75 - 2.5) 2 x (0.75 - 1.5)

## Design verification as per IEC/EN 61439

Technical data for design verification			
Rated operational current for specified heat dissipation	I <sub>n</sub>	A	100
Equipment heat dissipation, current-dependent	P <sub>vid</sub>	W	25.65
Operating ambient temperature min.		°C	-25
Operating ambient temperature max.		°C	70
IEC/EN 61439 design verification			
10.2 Strength of materials and parts			
10.2.2 Corrosion resistance			
10.2.2.1 Verification of thermal stability of enclosures			Meets the product standard's requirements.
10.2.3.2 Verification of resistance of insulating materials to normal heat			Meets the product standard's requirements.
10.2.3.3 Verification of resistance of insulating materials to abnormal heat and fire due to internal electric effects			Meets the product standard's requirements.
10.2.4 Resistance to ultra-violet (UV) radiation			Meets the product standard's requirements.
10.2.5 Lifting			Does not apply, since the entire switchgear needs to be evaluated.
10.2.6 Mechanical impact			Does not apply, since the entire switchgear needs to be evaluated.
10.2.7 Inscriptions			Meets the product standard's requirements.
10.3 Degree of protection of ASSEMBLIES			Does not apply, since the entire switchgear needs to be evaluated.

10.4 Clearances and creepage distances		Meets the product standard's requirements.
10.5 Protection against electric shock		Does not apply, since the entire switchgear needs to be evaluated.
10.6 Incorporation of switching devices and components		Does not apply, since the entire switchgear needs to be evaluated.
10.7 Internal electrical circuits and connections		Is the panel builder's responsibility.
10.8 Connections for external conductors		Is the panel builder's responsibility.
10.9 Insulation properties		
10.9.2 Power-frequency electric strength		Is the panel builder's responsibility.
10.9.3 Impulse withstand voltage		Is the panel builder's responsibility.
10.9.4 Testing of enclosures made of insulating material		Is the panel builder's responsibility.
10.10 Temperature rise		The panel builder is responsible for the temperature rise calculation. Eaton will provide heat dissipation data for the devices.
10.11 Short-circuit rating		Is the panel builder's responsibility. The specifications for the switchgear must be observed.
10.12 Electromagnetic compatibility		Is the panel builder's responsibility. The specifications for the switchgear must be observed.
10.13 Mechanical function		The device meets the requirements, provided the information in the instruction leaflet (IL) is observed.

## Technical data ETIM 6.0

Low-voltage industrial components (EG000017) / Motor protection circuit-breaker (EC000074)		
Electric engineering, automation, process control engineering / Low-voltage switch technology / Circuit breaker (LV < 1 kV) / Motor protection circuit-breaker (ecl@ss8.1-27-37-04-01 [AGZ529013])		
Overload release current setting	A	80 - 100
Adjustment range undelayed short-circuit release	A	800 - 1250
Thermal protection		No
Phase failure sensitive		No
Switch off technique		Thermomagnetic
Rated operating voltage	V	690 - 690
Rated permanent current I <sub>u</sub>	A	100
Rated operation power at AC-3, 230 V	kW	30
Rated operation power at AC-3, 400 V	kW	55
Type of electrical connection of main circuit		Screw connection
Type of control element		Rocker lever
Device construction		Built-in device fixed built-in technique
With integrated auxiliary switch		No
With integrated under voltage release		No
Number of poles		3
Rated short-circuit breaking capacity I <sub>cu</sub> at 400 V, AC	kA	150
Degree of protection (IP)		IP20
Height	mm	184
Width	mm	105
Depth	mm	149

# Characteristics

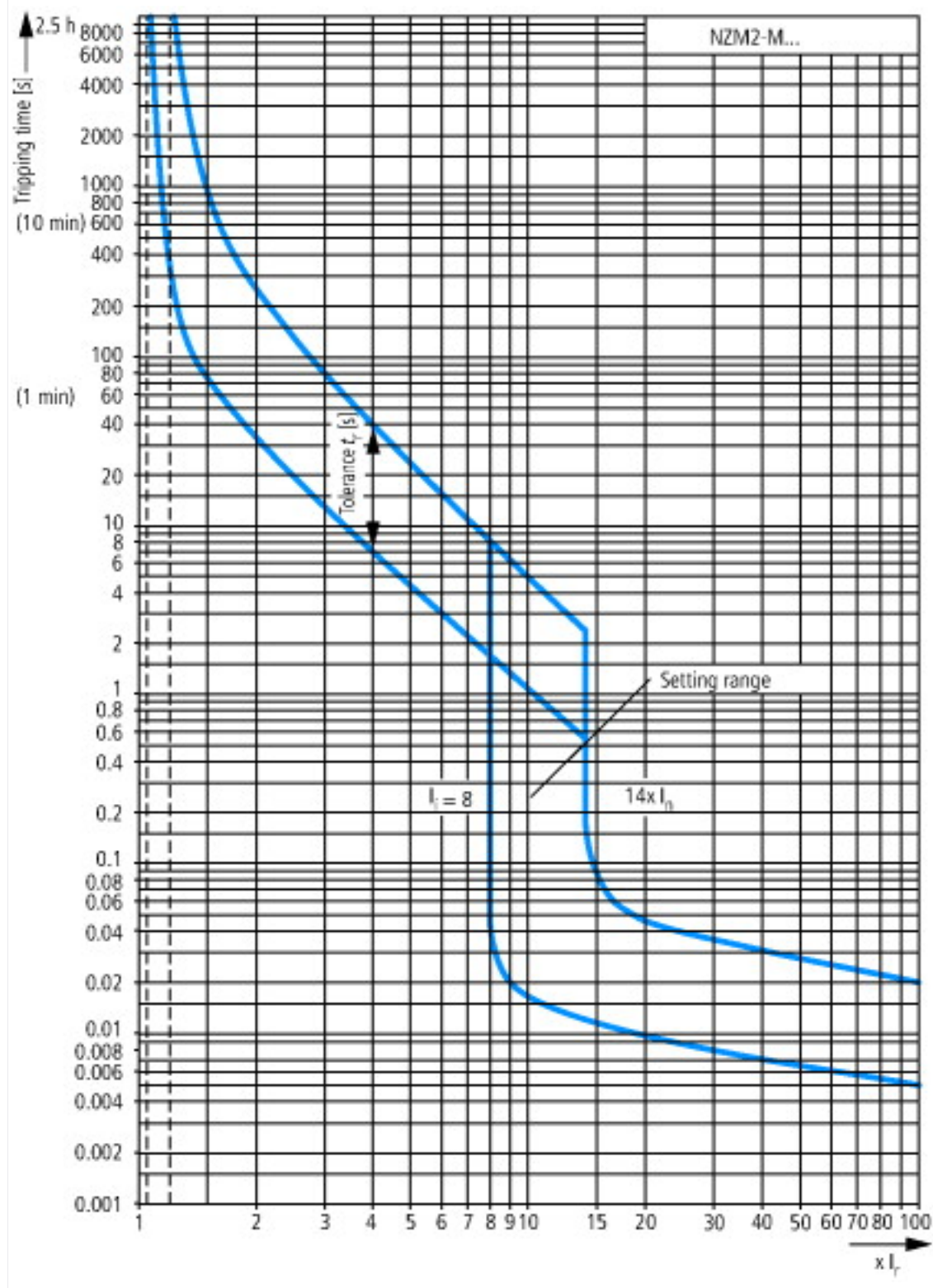

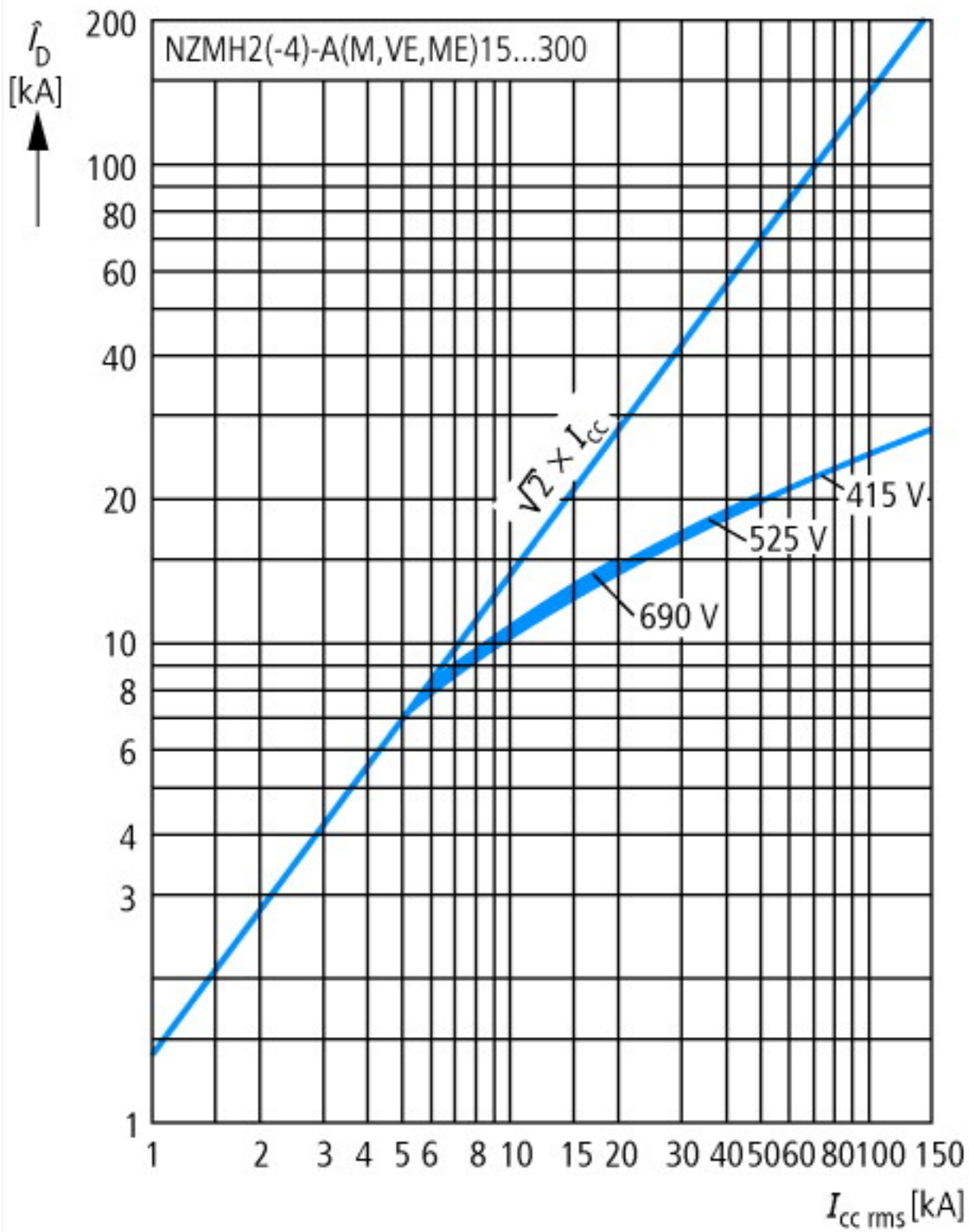

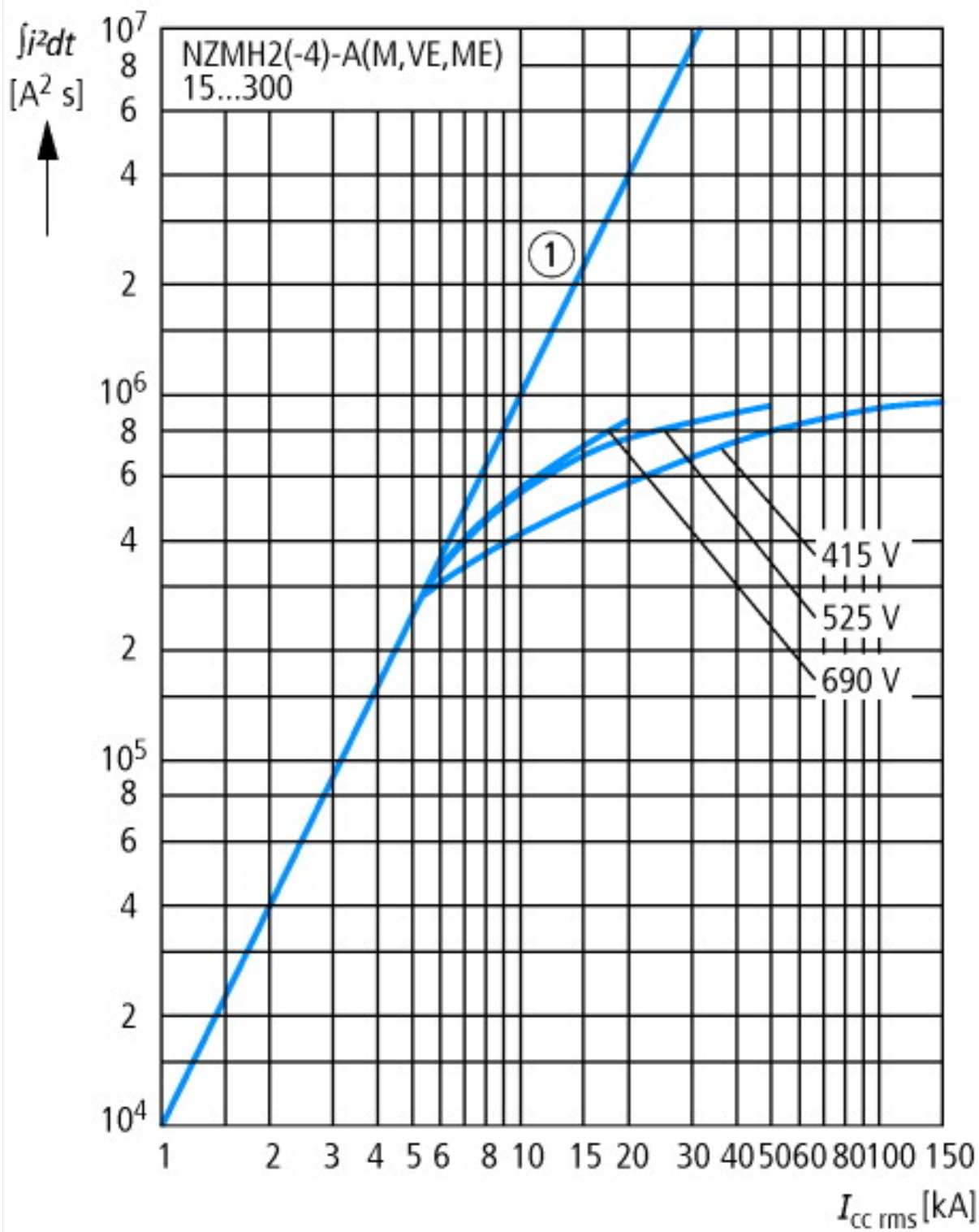



## Dimensions

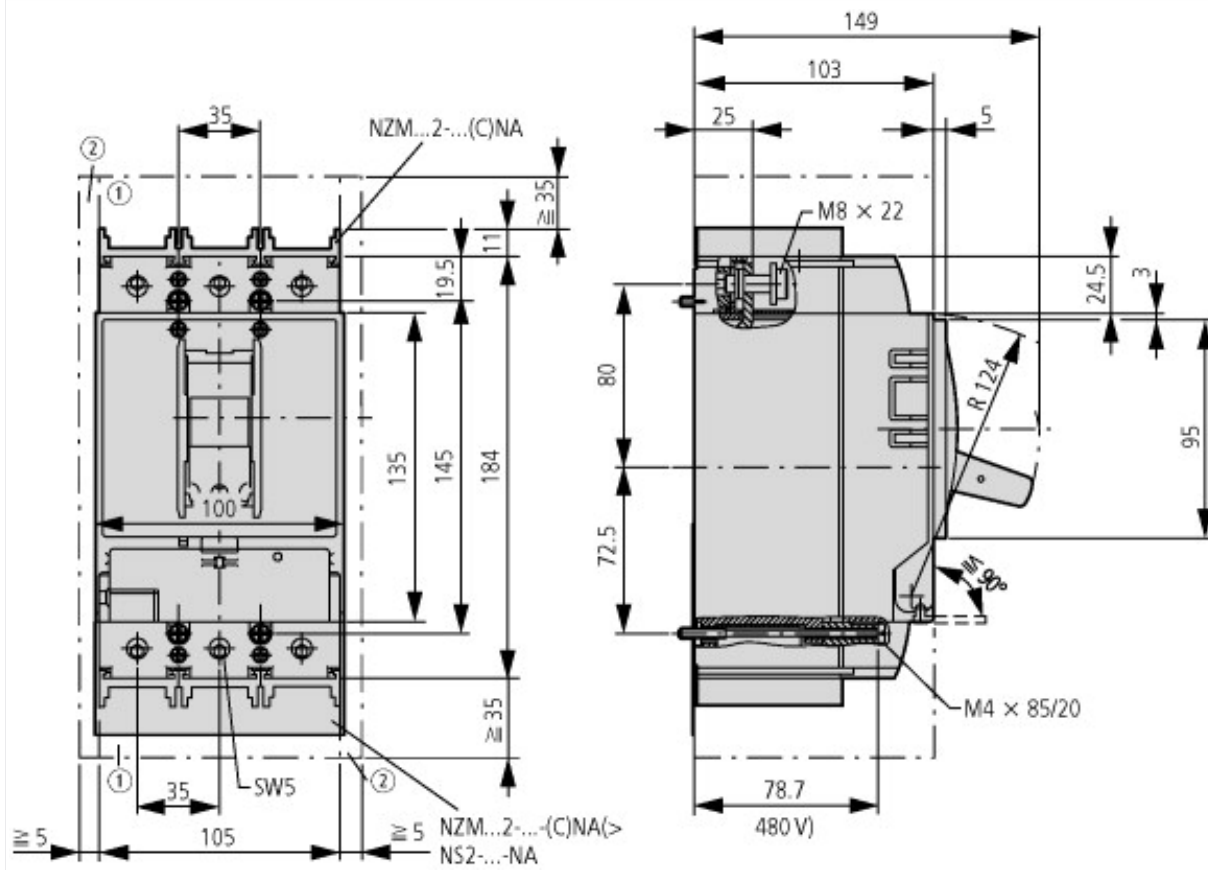

- ① Blow out area, minimum clearance to adjacent parts
- ② Minimum clearance to adjacent parts



### Additional product information (links)

#### IL01206006Z (AWA1230-1916) Circuit-Breaker, basic unit

IL01206006Z (AWA1230-1916) Circuit-Breaker, basic unit [ftp://ftp.moeller.net/DOCUMENTATION/AWA\\_INSTRUCTIONS/IL01206006Z2014\\_07.pdf](ftp://ftp.moeller.net/DOCUMENTATION/AWA_INSTRUCTIONS/IL01206006Z2014_07.pdf)

Weight <http://ecat.moeller.net/flip-cat/?edition=HPLEN&startpage=17.171>

Temperature dependency, Derating <http://ecat.moeller.net/flip-cat/?edition=HPLEN&startpage=17.172>

Effective power loss <http://ecat.moeller.net/flip-cat/?edition=HPLEN&startpage=17.174>

Setting-Specific Representation of Tripping Characteristics and Competent Assessment of their Interaction [http://www.moeller.net/binary/ver\\_techpapers/ver943en.pdf](http://www.moeller.net/binary/ver_techpapers/ver943en.pdf)

Busbar Component Adapters for modern Industrial control panels [http://www.moeller.net/binary/ver\\_techpapers/ver960en.pdf](http://www.moeller.net/binary/ver_techpapers/ver960en.pdf)