





Circuit-breaker 3p, 1600A, fixed

Part no. **IZMX16N3-V16F**
 Article no. **123375**

Delivery programme

Product range			Air circuit-breakers/switch-disconnectors
Product range			Open circuit-breakers
Current Range			Up to 4000 A
Protective function			Selective operation
Installation type			Fixed
Construction size			IZMX16
Release system			Electronic release
Standard/Approval			IEC
Number of poles			3 pole
Degree of Protection			IP20, IP55 with protective cover, IP41 door sealing frame suitable for zone selectivity optionally fittable by user with comprehensive accessories
Rated current – rated uninterrupted current	$I_n = I_u$	A	1600
Breaking capacity $I_{cu} = I_{cs}$ to 440 V 50/60 Hz	I_{cu}	kA	50
Breaking capacity I_{cs} to 440 V 50/60 Hz	I_{cs}	kA	50
Overload release, min.	I_r	A	800
Overload release, max.	I_r	A	1600
Non-delayed 	$I_i = I_n \times \dots$		2 - 12, OFF
Delayed 	$I_{sd} = I_r \times \dots$		2 - 10
Notes			
Main terminals not included, need to be ordered separately.			

Technical data

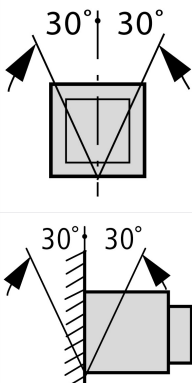
General			
Standards			IEC/EN 60947
Ambient temperature			
Storage	θ	°C	-40 - +70
Operating (open)		°C	-25 - +70
Mounting position			
Utilization category			B
Degree of Protection			IP20, IP55 with protective cover, IP41 door sealing frame
Direction of incoming supply			as required

Main conducting paths

Rated current = rated uninterrupted current	$I_n = I_u$	A	1600
---	-------------	---	------

Rated uninterrupted current at 50 °C	I_u	A	1600
Rated uninterrupted current at 60 °C	I_u	A	1600
Rated uninterrupted current at 70 °C	I_u	A	1600
Rated impulse withstand voltage	U_{imp}	V AC	12000
Rated operational voltage	U_e	V AC	690
Use in IT electrical power networks up to $U = 440$ V	I_{IT}	kA	23
Overvoltage category/pollution degree			III/3
Rated insulation voltage	U_i	V	1000

Switching capacity

Rated short-circuit making capacity	I_{cm}		
up to 440 V 50/60 Hz	I_{cm}	kA	105
up to 690 V 50/60 Hz	I_{cm}	kA	88
Rated short-time withstand current 50/60 Hz			
$t = 1$ s	I_{cw}	kA	42
Rated short-circuit breaking capacity I_{cn}	I_{cn}		
IEC/EN 60947 operating sequence I_{cu} 0-t-CO			
up to 240 V 50/60 Hz	I_{cu}	kA	85
up to 440 V 50/60 Hz	I_{cu}	kA	50
up to 690 V 50/60 Hz	I_{cu}	kA	42
IEC/EN 60947 operating sequence I_{cs} 0-t-CO-t-CO			
up to 240 V 50/60 Hz	I_{cs}	kA	50
up to 440 V 50/60 Hz	I_{cs}	kA	50
up to 690 V 50/60 Hz	I_{cs}	kA	42
Operating times			
Closing delay via spring release		ms	30
Total opening delay via shunt release		ms	25
Total opening delay via undervoltage release		ms	50
Total opening delay on non-delayed short-circuit release (up to complete arc quenching)		ms	25
Lifespan		S	
Lifespan, mechanical	Switching cycles (ON/OFF)		12500
Lifespan, mechanical with maintenance	Switching cycles (ON/OFF)		20000
Lifespan, electrical	Switching cycles (ON/OFF)		10000
Lifespan, electrical with maintenance	Switching cycles (ON/OFF)		10000
Maximum operating frequency	Operations/h		60
Heat dissipation at rated current I_n			
Fixed mounting		W	235

Weight

Fixed mounting			
3-pole		kg	19
4-pole		kg	24

Terminal capacities

Copper bar			
Fixed mounting			
Black		mm	2 x 5 x 100
Withdrawable units			
Black		mm	2 x 5 x 100

These are values used in separate switchgear. The actual values will depend on the temperature around the circuit-breaker, which is influenced by the ambient temperature, the degree of protection (IP), the mounting height, the partitions, and

any external ventilation. Depending on the specific switchgear design, this may result in derating, which can then be compensated for by increasing the cross-sectional area. Temperature rise tests in the specific switchgear can provide specific and detailed information.

Permissible continuous current for circuit-breakers operating in switchboards at various internal ambient temperatures. The switchboard's internal ambient temperature should be estimated using the calculation methods of IEC regulation.

Design verification as per IEC/EN 61439

Technical data for design verification			
Rated operational current for specified heat dissipation	I_n	A	1600
Equipment heat dissipation, current-dependent	P_{vid}	W	235
Operating ambient temperature min.		°C	-25
Operating ambient temperature max.		°C	70
IEC/EN 61439 design verification			
10.2 Strength of materials and parts			
10.2.2 Corrosion resistance			
Meets the product standard's requirements.			
10.2.3.1 Verification of thermal stability of enclosures			
Meets the product standard's requirements.			
10.2.3.2 Verification of resistance of insulating materials to normal heat			
Meets the product standard's requirements.			
10.2.3.3 Verification of resistance of insulating materials to abnormal heat and fire due to internal electric effects			
Meets the product standard's requirements.			
10.2.4 Resistance to ultra-violet (UV) radiation			
Meets the product standard's requirements.			
10.2.5 Lifting			
Does not apply, since the entire switchgear needs to be evaluated.			
10.2.6 Mechanical impact			
Does not apply, since the entire switchgear needs to be evaluated.			
10.2.7 Inscriptions			
Meets the product standard's requirements.			
10.3 Degree of protection of ASSEMBLIES			
Does not apply, since the entire switchgear needs to be evaluated.			
10.4 Clearances and creepage distances			
Meets the product standard's requirements.			
10.5 Protection against electric shock			
Does not apply, since the entire switchgear needs to be evaluated.			
10.6 Incorporation of switching devices and components			
Does not apply, since the entire switchgear needs to be evaluated.			
10.7 Internal electrical circuits and connections			
Is the panel builder's responsibility.			
10.8 Connections for external conductors			
Is the panel builder's responsibility.			
10.9 Insulation properties			
10.9.2 Power-frequency electric strength			
Is the panel builder's responsibility.			
10.9.3 Impulse withstand voltage			
Is the panel builder's responsibility.			
10.9.4 Testing of enclosures made of insulating material			
Is the panel builder's responsibility.			
10.10 Temperature rise			
The panel builder is responsible for the temperature rise calculation. Eaton will provide heat dissipation data for the devices.			
10.11 Short-circuit rating			
Is the panel builder's responsibility. The specifications for the switchgear must be observed.			
10.12 Electromagnetic compatibility			
Is the panel builder's responsibility. The specifications for the switchgear must be observed.			
10.13 Mechanical function			
The device meets the requirements, provided the information in the instruction leaflet (IL) is observed.			

Technical data ETIM 6.0

Low-voltage industrial components (EG000017) / Power circuit-breaker for trafo/generator/installation prot. (EC000228)			
Electric engineering, automation, process control engineering / Low-voltage switch technology / Circuit breaker (LV < 1 kV) / Circuit breaker for power transformer, generator and system protection (ecl@ss8.1-27-37-04-09 [AJZ716010])			
Rated permanent current I_u		A	1600
Rated voltage		V	690 - 690
Rated short-circuit breaking capacity I_{cu} at 400 V, 50 Hz		kA	50
Overload release current setting		A	800 - 1600
Adjustment range short-term delayed short-circuit release		A	3200 - 16000
Adjustment range undelayed short-circuit release		A	3200 - 19200
Integrated earth fault protection			No
Type of electrical connection of main circuit			Rail connection
Device construction			Built-in device fixed built-in technique
Suitable for DIN rail (top hat rail) mounting			No
DIN rail (top hat rail) mounting optional			No

Number of auxiliary contacts as normally closed contact	0
Number of auxiliary contacts as normally open contact	0
Number of auxiliary contacts as change-over contact	2
Switched-off indicator available	Yes
With under voltage release	No
Number of poles	3
Position of connection for main current circuit	Back side
Type of control element	Push button
Complete device with protection unit	Yes
Motor drive integrated	No
Motor drive optional	Yes
Degree of protection (IP)	IP20

Dimensions

