







## Circuit-breaker, 4 p, 40A

Part no. **LZMC1-4-A40-I**  
 Article no. **111911**

Similar to illustration

## Delivery programme

Product range				Circuit-breaker
Protective function				System and cable protection
Standard/Approval				IEC
Installation type				Fixed
Release system				Thermomagnetic release
Construction size				LZM1
Description				Set value in neutral conductor is synchronous with set value $I_r$ of main pole.
Number of poles				4 pole
Standard equipment				Box terminal
<b>Switching capacity</b>				
400/415 V 50/60 Hz	$I_{cu}$	kA		36
<b>Rated current = rated uninterrupted current</b>				
Rated current = rated uninterrupted current	$I_n = I_u$	A		40
Neutral conductor	% of phase conductor	CSA		100
<b>Setting range</b>				
Overload trip				
	$I_r$	A		32 - 40
Main pole	$I_r$	A		32 - 40
				
Short-circuit releases				
				
Non-delayed	$I_i = I_n \times \dots$			8 - 10
				

## Technical data

### General

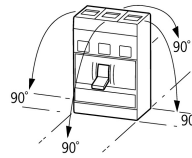
Standards				IEC/EN 60947, VDE 0660
Protection against direct contact				Finger and back-of-hand proof to VDE 0106 part 100
Climatic proofing				Damp heat, constant, to IEC 60068-2-78 Damp heat, cyclic, to IEC 60068-2-30
Mechanical shock resistance (10 ms half-sinusoidal shock) according to IEC 60068-2-27		g		20 (half-sinusoidal shock 20 ms)
Safe isolation to EN 61140				
Between auxiliary contacts and main contacts		V AC		500
between the auxiliary contacts		V AC		300
Mounting position				Vertical and 90° in all directions
				 <p>With XFI earth-fault release:          - NZM1, N1, NZM2, N2: vertical and 90° in all directions with plug-in unit          - NZM1, N1, NZM2, N2: vertical, 90° right/left with withdrawable unit:          - NZM3, N3: vertical, 90° left          - NZM4, N4: vertical</p>

with remote operator:  
 - NZM2, N(S)2, NZM3, N(S)3,  
 NZM4, N(S)4: vertical and 90° in all  
 directions

Direction of incoming supply		as required
Degree of protection		
Device		In the area of the HMI devices: IP20 (basic protection type)
Enclosures		with insulating surround: IP40with door coupling rotary handle: IP66
Terminations		Tunnel terminal: IP10 Phase isolator and band terminal: IP00

### Circuit-breakers

Rated current = rated uninterrupted current	$I_n = I_u$	A	40
Rated surge voltage invariability	$U_{imp}$		
Main contacts		V	6000
Auxiliary contacts		V	6000
Rated operational voltage	$U_e$	V AC	690
Overvoltage category/pollution degree			III/3
Rated insulation voltage	$U_i$	V	690
Use in unearthed supply systems		V	 690

### Switching capacity

Rated short-circuit making capacity	$I_{cm}$		
240 V 50/60 Hz	$I_{cm}$	kA	121
400/415 V 50/60 Hz	$I_{cm}$	kA	76
440 V 50/60 Hz	$I_{cm}$	kA	63
525 V 50/60 Hz	$I_{cm}$	kA	24
690 V 50/60 H	$I_c$	kA	14
Rated short-circuit breaking capacity $I_{cn}$	$I_{cn}$		
$I_{cu}$ to IEC/EN 60947 test cycle O-t-CO	$I_{cu}$	kA	
240 V 50/60 Hz	$I_{cu}$	kA	55
400/415 V 50/60 Hz	$I_{cu}$	kA	36
440 V 50/60 Hz	$I_{cu}$	kA	30
525 V 50/60 Hz	$I_{cu}$	kA	12
690 V 50/60 Hz	$I_{cu}$	kA	8
$I_{cs}$ to IEC/EN 60947 test cycle O-t-CO-t-CO	$I_{cs}$	kA	
230 V 50/60 Hz	$I_{cs}$	kA	55
400/415 V 50/60 Hz	$I_{cs}$	kA	36
440 V 50/60 Hz	$I_{cs}$	kA	22.5
525 V 50/60 Hz	$I_{cs}$	kA	6
690 V 50/60 Hz	$I_{cs}$	kA	4
			Maximum back-up fuse, if the expected short-circuit currents at the installation location exceed the switching capacity of the circuit-breaker.
Utilization category to IEC/EN 60947-2			A
Rated making and breaking capacity			
Rated operational current	$I_e$	A	
AC-1			
380 V 400 V	$I_e$	A	160
415 V	$I_e$	A	125
690 V	$I_e$	A	160
AC--3			
380 V 400 V	$I_e$	A	40
415 V	$I_e$	A	40
660 V 690 V	$I_e$	A	40
Lifespan, mechanical	Operations		20000
Lifespan, electrical			
AC-1			

400 V 50/60 Hz	Operations	10000
415 V 50/60 Hz	Operations	10000
690 V 50/60 Hz	Operations	7500
AC-2, AC-3		
415 V 50/60 Hz	Operations	7500
690 V 50/60 Hz	Operations	5000
Max. operating frequency	Ops/h	120
Current heat losses per pole at $I_u$ are based on the maximum rated operational current of the frame size.	W	16.7
		For current heat loss per pole the specification refers to the maximum rated operational current of the frame size.
Total downtime in a short-circuit	ms	< 10

### Terminal capacity

Standard equipment			Box terminal
Overview			<p>Basic equipment</p> <p>Box terminal ● - - -</p> <p>Screw connection - ● ● ●</p> <p>accessory consideration</p> <p>Box terminals - ● ● -</p> <p>Screw connection ● - - ●</p> <p>Tunnel terminal connection ● ● ● ●</p> <p>on rear Strip terminal - - - ●</p>
Round copper conductor			
Box terminal			
Solid		mm <sup>2</sup>	1 x (10 - 16) 2 x (6 - 16)
Stranded		mm <sup>2</sup>	1 x (25 - 70) 2 x 25
Tunnel terminal			
Solid		mm <sup>2</sup>	1 x (16 - 95)
Stranded		mm <sup>2</sup>	
Stranded		mm <sup>2</sup>	1 x (25 - 95)
Bolt terminal and rear-side connection			
Direct on the switch			
Solid		mm <sup>2</sup>	1 x (10 - 16) 2 x (6 - 16)
Stranded		mm <sup>2</sup>	1 x (25 - 70) 2 x 25
Al conductors, Cu cable			
Solid		mm <sup>2</sup>	1 x 16
Stranded		mm <sup>2</sup>	
Stranded		mm <sup>2</sup>	1 x (25 - 95)
Cu strip (number of segments x width x segment thickness)			
Box terminal			
	min.	mm	2 x 9 x 0.8
	max.	mm	9 x 9 x 0.8
Copper busbar (width x thickness)	mm		
Bolt terminal and rear-side connection			
Screw connection			M8
Direct on the switch			
	min.	mm	12 x 5
	max.	mm	16 x 5

Control cables			
		mm <sup>2</sup>	1 x (0.75 - 2.5) 2 x (0.75 - 1.5)

## Design verification as per IEC/EN 61439

Technical data for design verification			
Rated operational current for specified heat dissipation	I <sub>n</sub>	A	40
Equipment heat dissipation, current-dependent	P <sub>vid</sub>	W	10.656
IEC/EN 61439 design verification			
10.2 Strength of materials and parts			
10.2.2 Corrosion resistance			Meets the product standard's requirements.
10.2.3.1 Verification of thermal stability of enclosures			Meets the product standard's requirements.
10.2.3.2 Verification of resistance of insulating materials to normal heat			Meets the product standard's requirements.
10.2.3.3 Verification of resistance of insulating materials to abnormal heat and fire due to internal electric effects			Meets the product standard's requirements.
10.2.4 Resistance to ultra-violet (UV) radiation			Meets the product standard's requirements.
10.2.5 Lifting			Does not apply, since the entire switchgear needs to be evaluated.
10.2.6 Mechanical impact			Does not apply, since the entire switchgear needs to be evaluated.
10.2.7 Inscriptions			Meets the product standard's requirements.
10.3 Degree of protection of ASSEMBLIES			Does not apply, since the entire switchgear needs to be evaluated.
10.4 Clearances and creepage distances			Meets the product standard's requirements.
10.5 Protection against electric shock			Does not apply, since the entire switchgear needs to be evaluated.
10.6 Incorporation of switching devices and components			Does not apply, since the entire switchgear needs to be evaluated.
10.7 Internal electrical circuits and connections			Is the panel builder's responsibility.
10.8 Connections for external conductors			Is the panel builder's responsibility.
10.9 Insulation properties			
10.9.2 Power-frequency electric strength			Is the panel builder's responsibility.
10.9.3 Impulse withstand voltage			Is the panel builder's responsibility.
10.9.4 Testing of enclosures made of insulating material			Is the panel builder's responsibility.
10.10 Temperature rise			The panel builder is responsible for the temperature rise calculation. Eaton will provide heat dissipation data for the devices.
10.11 Short-circuit rating			Is the panel builder's responsibility. The specifications for the switchgear must be observed.
10.12 Electromagnetic compatibility			Is the panel builder's responsibility. The specifications for the switchgear must be observed.
10.13 Mechanical function			The device meets the requirements, provided the information in the instruction leaflet (IL) is observed.

## Technical data ETIM 6.0

Low-voltage industrial components (EG000017) / Power circuit-breaker for trafo/generator/installation prot. (EC000228)			
Electric engineering, automation, process control engineering / Low-voltage switch technology / Circuit breaker (LV < 1 kV) / Circuit breaker for power transformer, generator and system protection (ecl@ss8.1-27-37-04-09 [AJZ716010])			
Rated permanent current I <sub>u</sub>		A	40
Rated voltage		V	690 - 690
Rated short-circuit breaking capacity I <sub>cu</sub> at 400 V, 50 Hz		kA	36
Overload release current setting		A	32 - 40
Adjustment range short-term delayed short-circuit release		A	0 - 0
Adjustment range undelayed short-circuit release		A	320 - 400
Integrated earth fault protection			No
Type of electrical connection of main circuit			Frame clamp
Device construction			Built-in device fixed built-in technique
Suitable for DIN rail (top hat rail) mounting			No
DIN rail (top hat rail) mounting optional			Yes
Number of auxiliary contacts as normally closed contact			0
Number of auxiliary contacts as normally open contact			0
Number of auxiliary contacts as change-over contact			0
Switched-off indicator available			No
With under voltage release			No

Number of poles		4
Position of connection for main current circuit		Front side
Type of control element		Rocker lever
Complete device with protection unit		Yes
Motor drive integrated		No
Motor drive optional		No
Degree of protection (IP)		IP20

## Characteristics

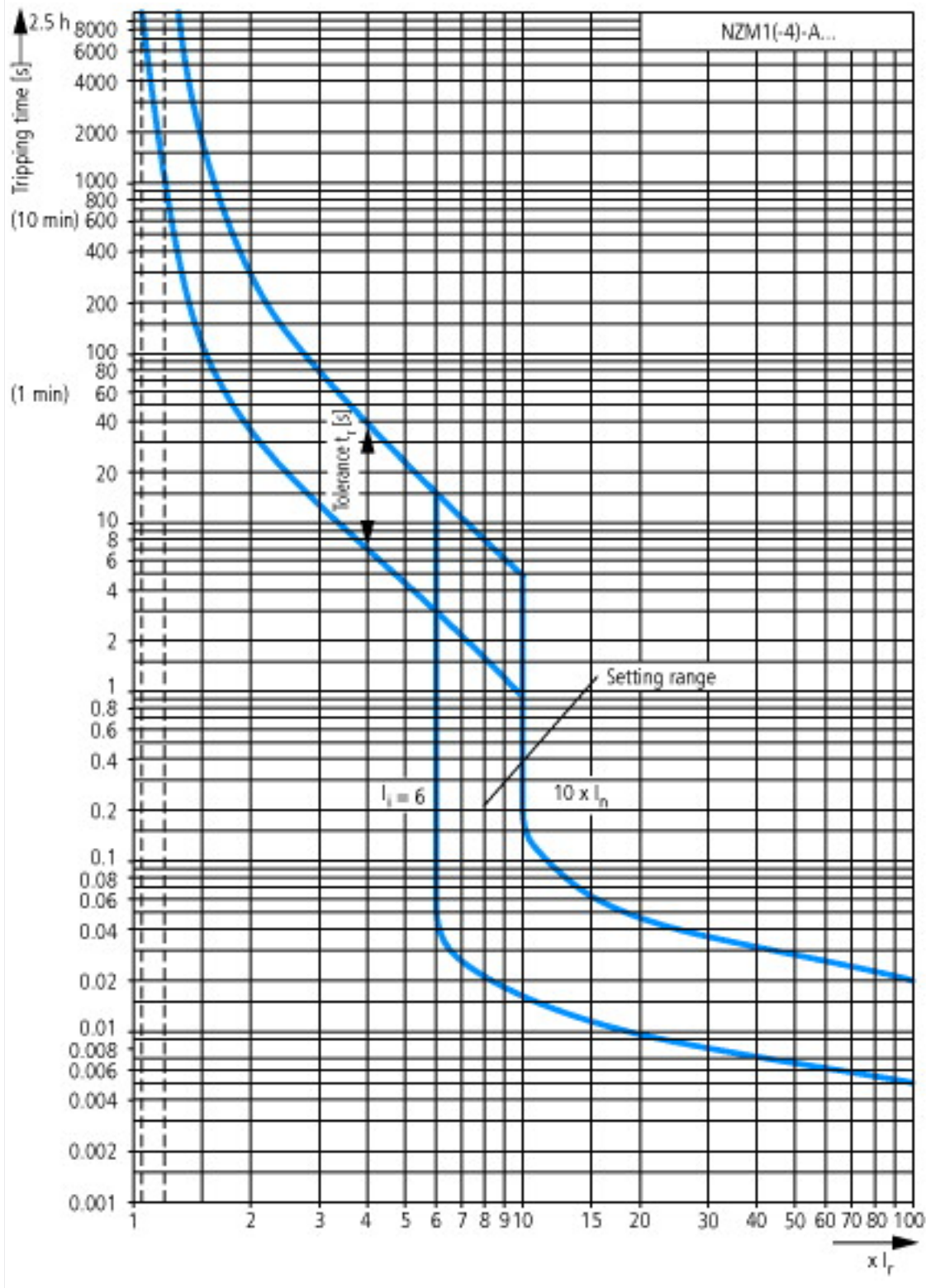

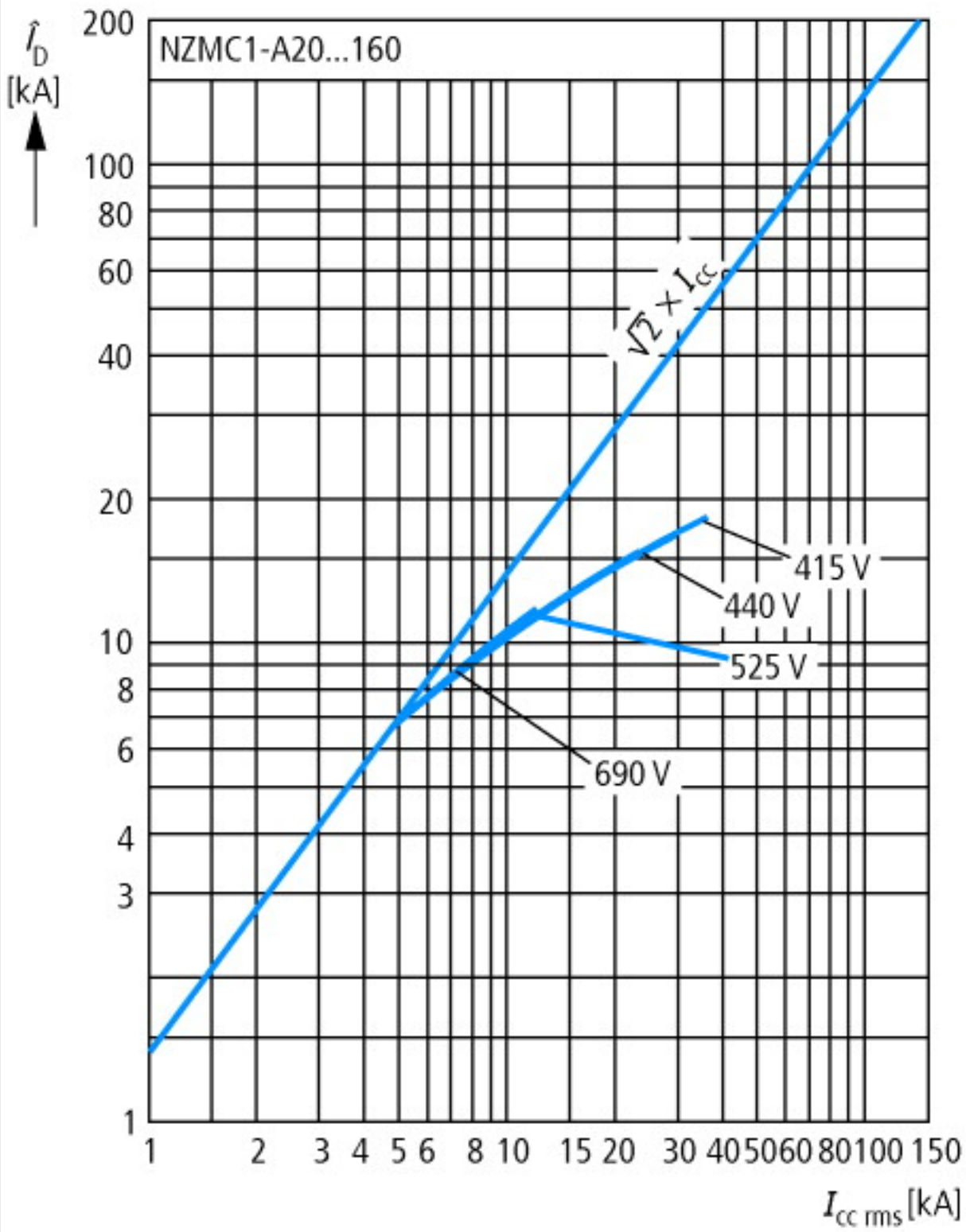

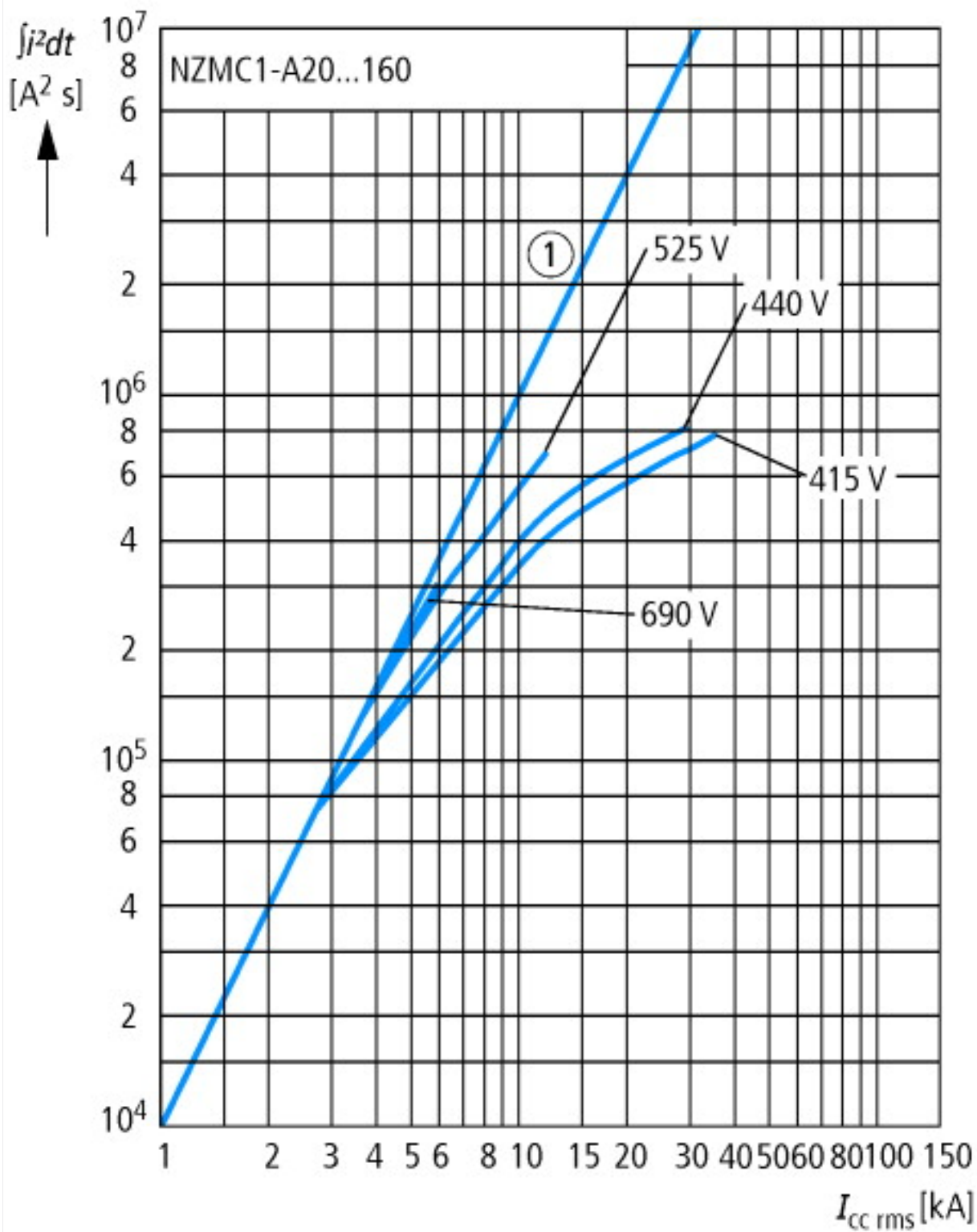

## Dimensions

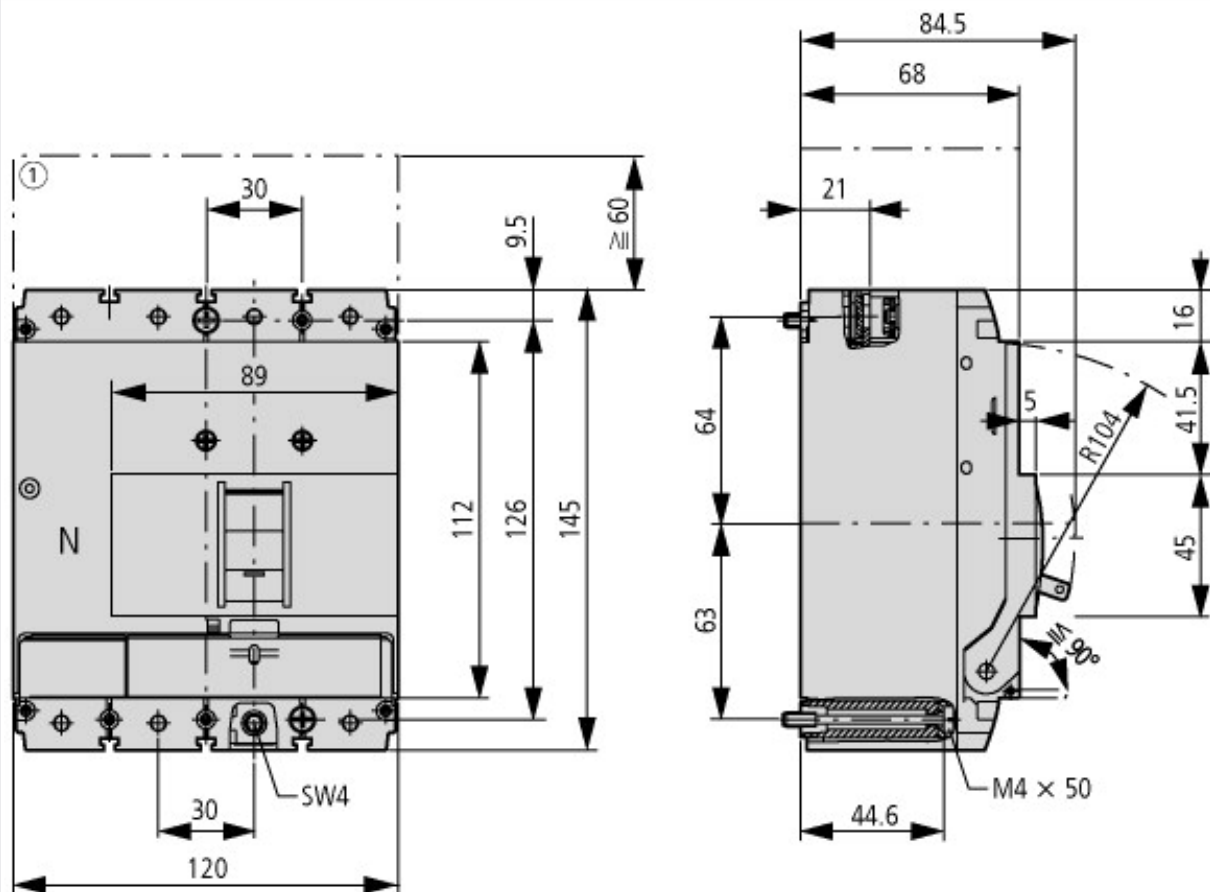

① Blow out area, minimum clearance to other parts





### Additional product information (links)

**IL01203007Z circuit-breaker LZM.1(-4), switch-disconnector LN1**

IL01203007Z circuit-breaker LZM.1(-4), switch-disconnector LN1 [ftp://ftp.moeller.net/DOCUMENTATION/AWA\\_INSTRUCTIONS/IL01203007Z2011\\_01.pdf](ftp://ftp.moeller.net/DOCUMENTATION/AWA_INSTRUCTIONS/IL01203007Z2011_01.pdf)