



Automatización Eléctrica

Especialistas en Automatización

At the end of this document you will find links to products related to this catalog. You can go directly to our shop by clicking HERE. [HERE](#)

Motor Controllers

3-Phase Analog Power Controller

Types RSC-AAM60/RSO

CARLO GAVAZZI



- Control and output modules for analogue control of 3-phase induction motors or heaters
- Rated operational current: 3 x 10, 25, 50, 90, 110 AACrms
- Rated operational voltage: Up to 600 VACrms
- Supply voltage range: 10 to 32 VDC
- Control current range: 0 to 20 mA/4 to 20 mA
- LED-indication for line ON and load ON
- Varistor protection
- Approvals: CE, CCC, UL, CSA

Product Description

The micro processor based control module RSC-AAM60 is used with output modules RSO... to achieve a voltage controlled soft start/soft stop of 3-phase motors and a possibility for energy reduction when e.g. a fan is running with a variable capacity. This function is achieved by controlling the control module with a current between 4 and 20 mA (0 and 20 mA). The output mod-

ule can be selected according to the rated operational voltage and the size of the load.

This phase angle controlled soft-start unit can be used for pumps, fans, heaters, lights and many other applications.

LED indications for line ON and load ON gives a clear status indication.

Ordering Key

- Solid State Relay
- Soft starting/stopping
- Control module
- Output module
- Control input type
- Multivoltage
- Rated operational voltage
- Rated operational current

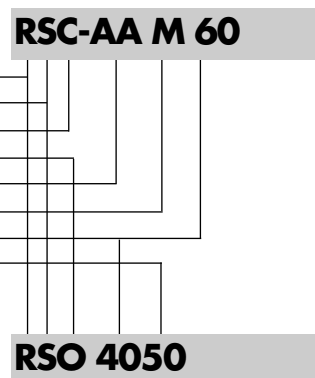

Type Selection, Control Module

Control current	Mains	Max. operational voltage	Type Number
0-20 mA/4-20 mA	Multivoltage	600 VAC	RSC-AA M 60

Type Selection, Output Module

Rated operational voltage	Rated operational current				
	10 A	25 A	50 A	90 A	110 A
3 x 220 VAC	RSO 2210	RSO 2225	RSO 2250	RSO 2290	RSO 22110
3 x 400 VAC	RSO 4010	RSO 4025	RSO 4050	RSO 4090	RSO 40110
3 x 480 VAC	RSO 4810	RSO 4825	RSO 4850	RSO 4890	RSO 48110
3 x 600 VAC			RSO 6050	RSO 6090	RSO 60110

General Spec., Control Module

Operational voltage range Line to line	150 to 660 VACrms
Operational frequency range	45 to 65 Hz
Supply current @ no output current @ max. output current	< 30 mA < 180 mA
Supply voltage range	10 to 32 VDC
CE-marking	Yes
Approvals	UL, CSA, CCC

Control Specifications

Minimum output voltage	Power supply minus 8 VDC
Output current short-circuit protected	≤ 150 mA DC

Thermal Specifications

Operating temperature	-20° to +70°C (-4° to +158°F)
Storage temperature	-40° to +100°C (-40° to +212°F)

Control Input Specifications

Control current	
A-input	0 to 20 mA
B-input	4 to 20 mA
Input impedance	250 Ω
Power supply reset time	\leq 300 ms
Response time (input to trigger outputs)	\leq 1 cycle

Isolation Control Module

Rated isolation voltage Input to trigger outputs	\geq 4000 VACrms
---	--------------------

Operation Diagram

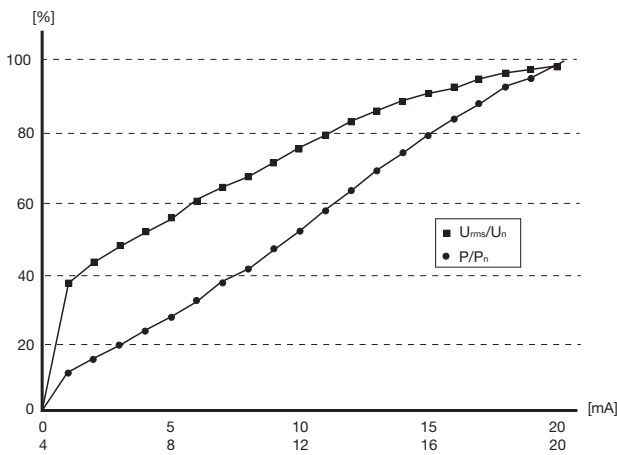
Output as a function of control current @cos(ϕ) = 0.9

Mode of Operation

The control module RSC-AAM60 is used with the output module RSO..... to achieve analog control of 3-phase induction motors.

Soft starting is achieved by increasing the motor voltage in accordance with the input current. Soft stopping is achieved by decreasing the motor voltage in accordance with the input current.

When the motor is running idle, the motor voltage can be reduced by lowering the input current, whereby energy is saved.

Heating elements can also be controlled with the RSC/RSO with the use of appropriate filters.

General Specifications, Output Module

	RSO 22...	RSO 40...	RSO 48...	RSO 60...
Operational voltage range Line to line	150 to 250 VACrms	220 to 420 VACrms	400 to 510 VACrms	400 to 625 VACrms
Blocking voltage	1200 V _p	1200 V _p	1200 V _p	1600 V _p
Varistor voltage	275 VAC	420 VAC	510 VAC	625 VAC
CE-marking	Yes	Yes	Yes	Yes

Output Specifications, Output Module

	RSO ..10	RSO ..25	RSO ..50	RSO ..90	RSO ..110
IEC and CCC Rated Operational Current AC 51	16 Arms	25 Arms	50 Arms	90 Arms	110 Arms
IEC and CCC rated operational current AC 53a	3 Arms	5 Arms	15 Arms	30 Arms	40 Arms
Number of starts/hr @40°C	7*	7*	7*	50*	50*
Overload cycle according to EN/ IEC 60947-4-2 @ 40°C	3A: AC53a: 4 - 4:100 - 7*	3A: AC53a: 4 - 4:100 - 7*	3A: AC53a: 4 - 4: 100 - 7*	3A: AC53a: 4 - 4:100 - 50*	3A: AC53a: 4 - 4: 100 - 50*
Off-state leakage current	\leq 10 mArms	\leq 10 mArms	\leq 10 mArms	\leq 25 mArms	\leq 25 mArms
On-state voltage drop	\leq 1.6 Vrms	\leq 1.6 Vrms	\leq 1.6 Vrms	\leq 1.8 Vrms	\leq 1.8 Vrms
I ² t for fusing t=10 ms	\leq 130 A ² s	\leq 525 A ² s	\leq 1800 A ² s	\leq 6600 A ² s	\leq 18000 A ² s
Non-rep. surge current t=10 ms	160 A _p	325 A _p	600 A _p	1150 A _p	1900 A _p

* Mounted on RHS 301

Thermal Specifications Output Module

	RSO ..10	RSO ..25	RSO ..50	RSO ..90	RSO ..110
Operating temperature	-20° to +70°C (-4° to +158°F)	-20° to +70°C (-4° to +158°F)	-20° to +70°C (-4° to +158°F)	-20° to +70°C (-4° to +158°F)	-20° to +70°C (-4° to +158°F)
Storage temperature	-40° to +100°C (-40° to +212°F)	-40° to +100°C (-40° to +212°F)	-40° to +100°C (-40° to +212°F)	-40° to +100°C (-40° to +212°F)	-40° to +100°C (-40° to +212°F)
Junction temperature	≤ 125°C	≤ 125°C	≤ 125°C	≤ 125°C	≤ 125°C
R_{th} junction to case	≤ 0.7 K/W	≤ 0.5 K/W	≤ 0.25 K/W	≤ 0.1 K/W	≤ 0.09 K/W

Functional Diagram

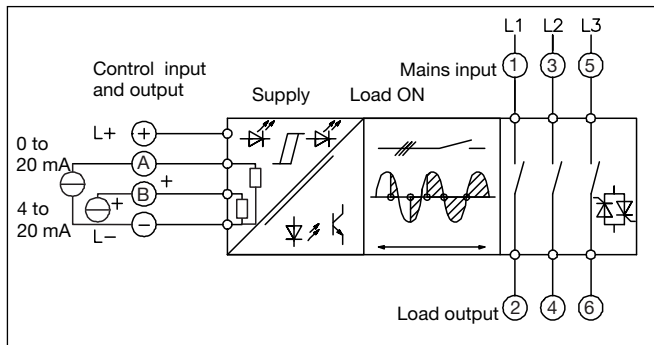

Wiring Diagram

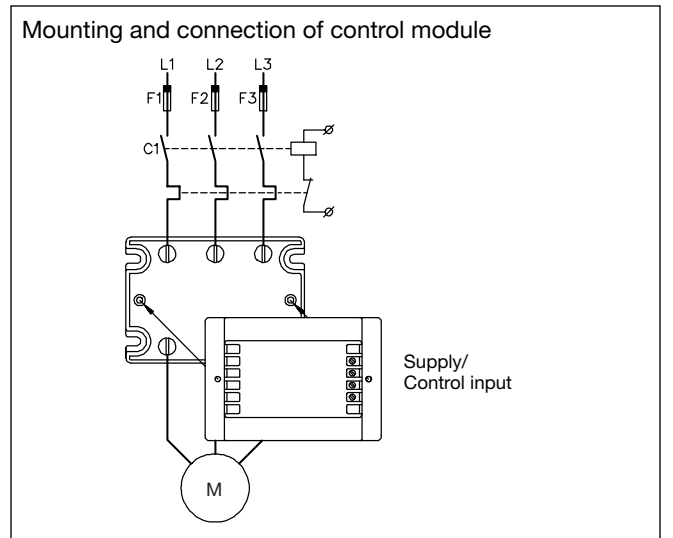

Accessories

- Heatsinks
- Fuses
- Temperature limit switch
- Power supply

For further information refer to "General Accessories".

Dimensions

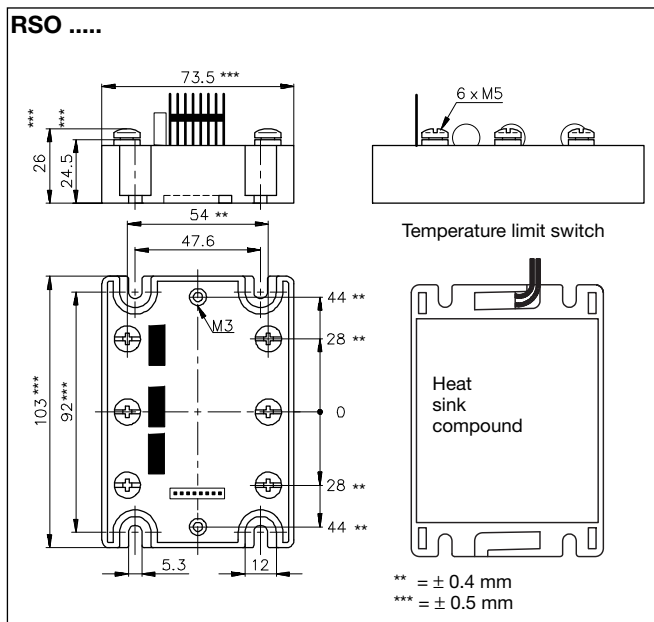

All dimensions in mm

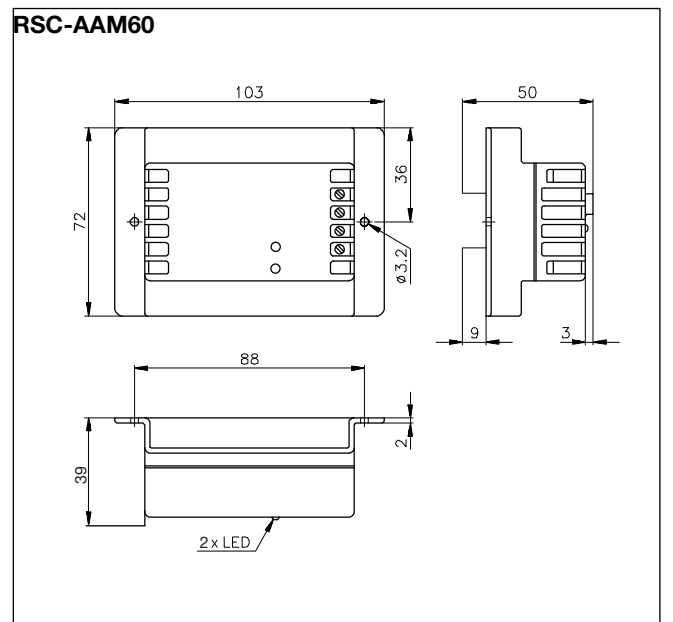

All dimensions in mm



Heatsink Dimensions (load current versus ambient temperature)

RSO ..10

Load current [A]	Thermal resistance [K/W]					Power dissipation [W]	Temp. protection [°C]
16	0.97	0.81	0.65	0.48	0.32	62	80°C
15	1.1	0.88	0.71	0.53	0.35	57	
14	1.2	0.97	0.77	0.58	0.39	52	
13	1.3	1.1	0.85	0.64	0.43	47	
12	1.4	1.2	0.95	0.71	0.47	42	
11	1.6	1.3	1.1	0.80	0.53	38	
10	1.8	1.5	1.2	0.90	0.60	33	
9	2.1	1.7	1.4	1	0.69	29	
7	2.8	2.3	1.9	1.4	0.93	21	
5	4.2	3.5	2.8	2.1	1.4	14	
3	7.4	6.2	4.9	3.7	2.5	8	
1	23.8	19.8	15.9	11.9	7.9	3	
	20	30	40	50	60	T _A	Ambient temp. [°C]

RSO ..25

Load current [A]	Thermal resistance [K/W]					Power dissipation [W]	Temp. protection [°C]	
25	0.66	0.55	0.44	0.33	0.22	91	80°C	
22.5	0.76	0.63	0.51	0.38	0.25	79		
20	0.88	0.74	0.59	0.44	0.29	68		
17.5	1.1	0.87	0.70	0.52	0.35	57		
15	1.3	1.1	0.85	0.63	0.42	47		
12.5	1.6	1.3	1.1	0.79	0.53	38		
10	2.1	1.7	1.4	1	0.69	29		
7.5	2.9	2.4	1.9	1.4	0.96	21		
5	4.5	3.8	3	2.3	1.5	13		
2.5	9.4	7.8	6.3	4.7	3.1	6		
	20	30	40	50	60	T _A		Ambient temp. [°C]

RSO ..50

Load current [A]	Thermal resistance [K/W]					Power dissipation [W]	Temp. protection [°C]
50	0.33	0.28	0.22	0.16	0.11	181	80°C
45	0.38	0.32	0.25	0.19	0.13	158	
40	0.44	0.37	0.29	0.22	0.15	136	
35	0.52	0.43	0.35	0.26	0.17	116	
30	0.63	0.52	0.42	0.31	0.21	96	
25	0.78	0.65	0.52	0.39	0.26	77	
20	1	0.84	0.67	0.50	0.34	60	
15	1.4	1.2	0.93	0.69	0.46	43	
10	2.2	1.8	1.4	1.1	0.72	28	
5	4.5	3.8	3	2.3	1.5	13	
	20	30	40	50	60	T _A	Ambient temp. [°C]

RSO ..90, RSO ..110

Load current [A]	Heatsink/Thermal resistance [K/W]					Power dissipation [W]	Temp. protection [°C]
90	0.13	0.10	0.07	0.04	-	304	80°C
80	0.19	0.15	0.12	0.08	0.04	260	
70	0.27	0.22	0.18	0.13	0.09	219	
60	0.33	0.28	0.22	0.17	0.11	181	
50	0.41	0.35	0.28	0.21	0.14	145	
40	0.54	0.45	0.36	0.27	0.18	111	
30	0.75	0.63	0.50	0.38	0.25	80	
20	1.2	0.99	0.79	0.59	0.39	51	
10	2.5	2.1	1.7	1.2	0.83	24	
	20	30	40	50	60	T _A	

Heatsink Selection

Carlo Gavazzi Heatsink (see Accessories)	Thermal resistance
No heatsink required	$R_{th\ s-a} > 8.0$ K/W
RHS 300 Assy or backplate	5.0 K/W
RHS 301 Assy	0.8 K/W
RHS 301 F Assy	0.25 K/W
Consult your distributor	< 0.25 K/W

Compare the value found in the load current versus temperature chart with the standard heatsink values and select the heatsink with the next lower value.

It is recommended to protect the solid state relay against overheating. Therefore the chart also states the maximum switching temperature (70, 80 or 90 °C) for the optional temperature limit switch.

Housing Specifications

Weight RSO ..10, ..25, ..50 RSO ..90, ..110	Approx. 275 g Approx. 385 g	Relay Mounting screws Mounting torque	M5 ≤ 1.5 Nm
Housing material Colour	Noryl, glass-reinforced Black	Control terminal Mounting screws Mounting torque	M3 ≤ 0.5 Nm
Base plate @ ≤ 50 A @ ≥ 90 A	Aluminium, nickel-plated Copper, nickel-plated	Power terminal Mounting screws Mounting torque	M5 x 6 ≤ 1.5 Nm
Potting compound	Polyurethane, black		

Applications

The output module RSO ..110 is recommended for motors up to 22 kW @ 400 V. The RSO ..110 is designed for use in applications with high surge current conditions. Care must be taken to ensure proper heat-sinking when the relays are to be used at high nominal currents. Adequate electrical connection between relay terminals and cable must be ensured.

Example 1:
Power dissipation - RSO 40110:

$I_{load} = 40 \text{ Arms} = 111 \text{ W}$
See previous page.

Example 2:
Motor: 3 kW, 4 HP
3 x 400 VAC, 4-pole
 $T_A: 50^\circ\text{C}$
Starting time: ≤ 5 s

For this application RSC-AAM60 must be used. The output module RSO4025 is selected according to the Selection Guide.

The smallest heatsink required is 1 K/W, and the power dissipation is 25 W.

This gives:
Control module:
RSC-AAM60
Output module: RSO 4025
Heatsink: 1K/W

Connection to the mains
Since no motor protective circuitry is included in the RSC/RSO, the motor must be protected in the usual way, i.e. either by a thermal relay, a PTC-resistor or a Klixon bimetal temperature switch near the motor windings.

If short circuit protection is required, fuses F1 to F3 should be ultrafast and selected according to the load integral (I^2t) of the RSO output module and the motor load.

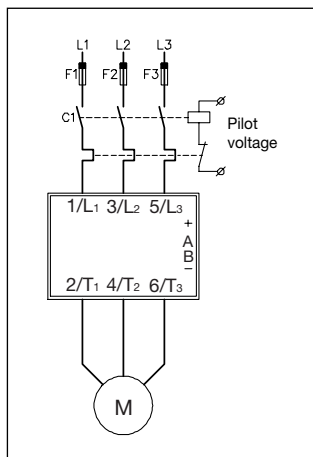

Overload protection by thermal relay

Transient voltage protection
With an unfiltered main supply, voltage transient may occur. Since these transients could have a high energy content, it is advisable to use varistors to protect the output module.

The varistors are already mounted in the RSO output module and they are selected according to the rated operational voltage.

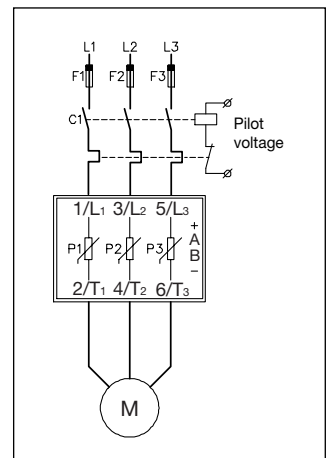

Energy saving for motors in idle mode

When motors are running idle, it not necessary to maintain a full magnetic field, as is the case when the motor has to produce full torque. By lowering the motor voltage, power losses inside the motor are also reduced.

When the motor is idle, d1 will switch the control current from $I_1 > 20 \text{ mA}$ to I_2 , which is adjusted to a value at which the motor is still running at full speed, but at a lower voltage. Please remark that this type of phase-angle controlled voltage reduction, demands additional filtering to fulfill EMC regulations.

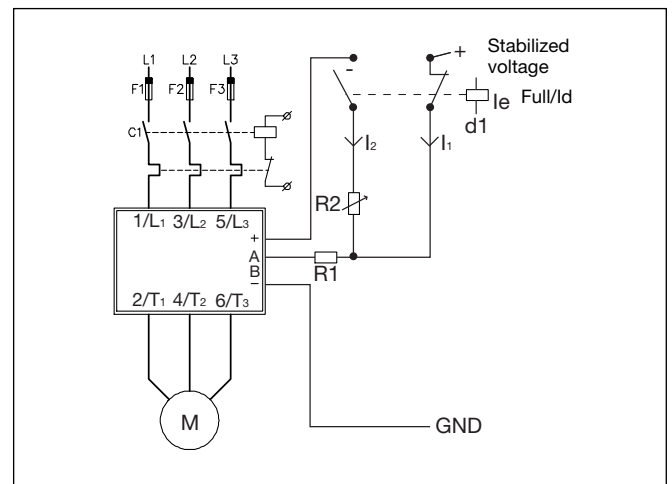



Applications (cont.)

In order to achieve a 4 to 20 mA signal from a 12 or 24 VDC source, a resistor and a potentiometer should be connected in series with the voltage source and the RSC controller.

We define the I_{max} to be e.g. 24 mA, which means that the series resistors must be:

$$R_1 (12 V) = U/I - R_{int} = 12 V/24 mA - 250 \Omega = 250 \Omega$$

$$R_1 (24 V) = U/I - R_{int} = 24 V/24 mA - 250 \Omega = 750 \Omega$$

If the minimum current is defined to be e.g. 2.4 mA and the 250 Ω R_{int} input resistance of the RSC is also calculated in:

$$R_2 (12 V) = U/I - R_1 - R_{int} = 12/2.4 - 250 - 250 = 4500 \Omega$$

$$R_2 (24 V) = U/I - R_1 - R_{int} = 24/2.4 - 750 - 250 = 9000 \Omega$$

Selection Guide

400 VACrms and 480 VACrms motors

Output module	RSO ..10	RSO ..25	RSO ..50	RSO ..90	RSO ..110
Max. motor size	3 HP/2.2 kW	5 HP/4 kW	15 HP/11 kW	20 HP/15 kW	30 HP/22 kW

600 VACrms motors

Output module			RSO 6050	RSO 6090	RSO 60110
Max. motor size			15 HP	30 HP	40 HP

Wiring Diagram (0-10 VDC control)

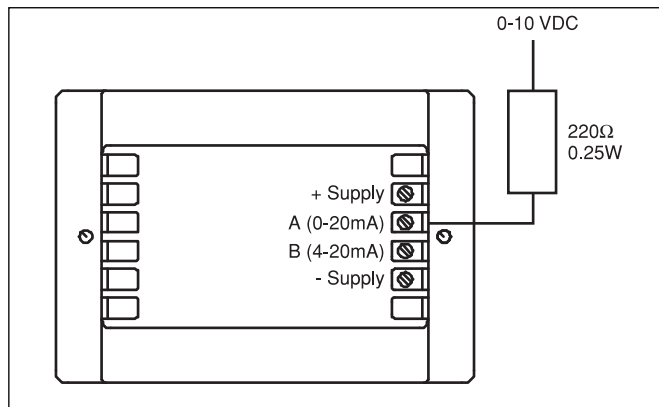

Short circuit Protection (according to EN/IEC 60947-4-2)

Type of coordination: 2
Rated short circuit current

RSO...25 RSO...10	RSO...50	RSO...90	RSO...110
5kA when protected by semiconductor fuses. Ferraz Shawmut 25A, Class URQ Art. No. 6.9 CP gRC 14.51/ 25	5kA when protected by semiconductor fuses. Ferraz Shawmut 63A, Class URQ Art. No. 6.921 CP URQ 27 x 60/ 63	5kA when protected by semiconductor fuses. Ferraz Shawmut 80A, Class URQ Art. No. 6.921 CP URQ 27 x 60/ 80	5kA when protected by semiconductor fuses. Ferraz Shawmut 100A, Class URQ Art. No. 6.921 CP URQ 27 x 60/ 100



Below is a list of articles with direct links to our shop Electric Automation Network where you can see:

- Quote per purchase volume in real time.
- Online documentation and datasheets of all products.
- Estimated delivery time enquiry in real time.
- Logistics systems for the shipment of materials almost anywhere in the world.
- Purchasing management, order record and tracking of shipments.

To access the product, [click on the green button.](#)

Product	Code	Reference	Product link
Selected parameters SYSTEM Output Module LOAD Phase 3 HOUSING WIDTH >45mm to 90mm MOTOR RATING >14kW to 20kW OPERATIONAL VOLTAGE Up to 550VAC LOAD CURRENT >75A to 100A CONTROLLED PHASES 3-Phase Others LOAD (result) Output module for soft starting/ stopping of 3-phase induction motors LOAD CURRENT 90A AC MAX MOTOR RATING 15 kW OPERATIONAL VOLTAGE 400-625V ACrms DIMENSIONS 103 x 73.5 x 40 mm CONTROLLED PHASES 3-Phase	RSO6090		Buy on EAN