



Automatización Eléctrica

Especialistas en Automatización

At the end of this document you will find links to products related to this catalog. You can go directly to our shop by clicking [HERE](#). [HERE](#)

Control- and isolating transformer STU 63/2x115

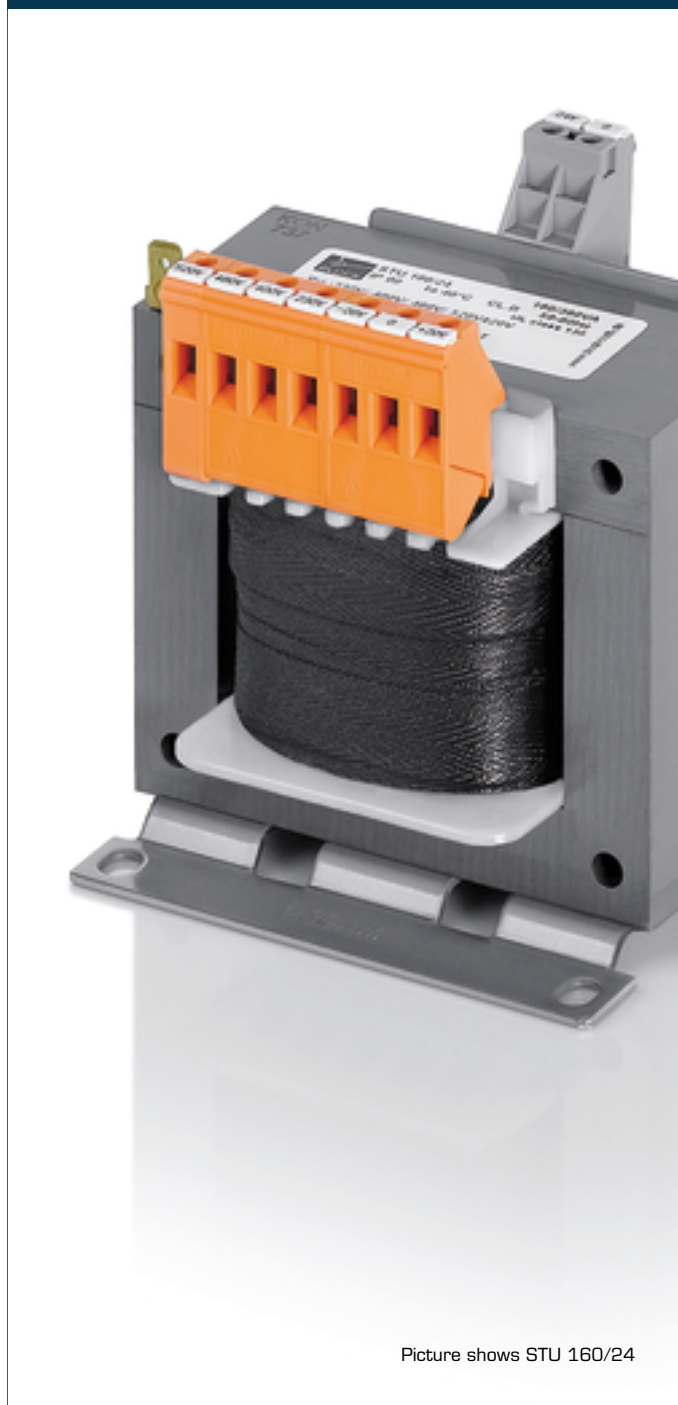

Picture shows STU 160/24

Advantages

Universal input voltages 210 to 540 Vac

Very good switch-on behaviour thanks to reduced starting currents

High performance for the volume thanks to compact design

Very good corrosion protection and low noise thanks to BLOCKIMPEX vacuum impregnation

Contact protected screw connection terminals complying with UVV BGV A3

Simple mounting thanks to robust metal footplate with oval slots

Applications

As a control transformer for the electrical isolation of the input and output sides. The construction of the transformer to supply control systems according to VDE 0113 is designed.

As an isolating transformer for the safe electrical isolation of the input and output sides. The transformer may be used to set up protective separation as a protective measure in accordance with VDE 0100.

As a safety isolating transformer for the safe electrical isolation of the input and output sides. The transformer is suitable for creating SELV and PELV circuits because of the limit on the output voltage.

Sample application

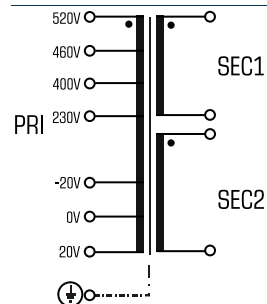

Standards



Control transformer
to: VDE 0570 Teil 2-2, DIN EN 61558-2-2, EN 61558-2-2, IEC 61558-2-2,
UL 5085-1/-2, CSA 22.2 No.66
Isolating transformer
to: VDE 0570 Part 2-4, DIN EN 61558-2-4, EN 61558-2-4, IEC 61558-2-4,
UL 5085-1/-2, CSA 22.2 No.66

Approvals



ENEC 10 (VDE), UL 5085-1/-2, CSA 22.2 No.66



Control- and isolating transformer STU 63/2x115

Type		STU 63/2x115	
Electrical data	Input		
	Rated input voltage	210 Vac/230 Vac/250 Vac 380 Vac/400 Vac/420 Vac 440 Vac/460 Vac/480 Vac 500 Vac/520 Vac/540 Vac	
	Rated frequency	50 - 60 Hz	
	Output		
	Rated output voltage	2 x 115 Vac	
	Rated power VDE (DB cos phi=1)	63 VA	
	Rated power VDE (KB cos phi=0.5)	110 VA	
	No-load voltage (app. x factor)	1.10	
	Efficiency	84 %	
	Standards		
	Classification	Control- and isolating transformer	
	Approvals		
	Approvals	cURus, ENEC 10 (VDE)	
	Environment		
	Ambient temperature max.	40 °C	
	Type of cooling	self-cooling	
	Safety and protection		
	Type	Open type	
	Class of Insulation System	VDE=B, UL=class 105	
	Protection index	IP 00	
	Safety class (prepared)	I	
	Short circuit strength	non-short-circuit proof	
	PRI Fusing recommendation by circuit breaker with tripping characteristic type 20 x I _{rated} related to set)		
	Setting range 230 ±20 Vac	0.25 - 0.40 A	
	Setting value 230 ±20 Vac	0.30 A	
	Setting range 400 ±20 Vac	0.16 - 0.25 A	
	Setting value 400 ±20 Vac	0.20 A	
	Setting range 460 ±20 Vac	0.16 - 0.25 A	
	Setting value 460 ±20 Vac	0.17 A	
	Setting range 520 ±20 Vac	0.10 - 0.16 A	
	Setting value 520 ±20 Vac	0.15 A	
	Order numbers		
	Order Number	STU 63/2x115	

Type		STU 63/2x115
Mechanical data	Terminal and mounting	
	Fixing method	Base plate
	Fixing screws	M4
	Terminals	Screw-type terminals, PE 6.3 x 0.8
	Measures and weights	
	Weight	1.50 kg

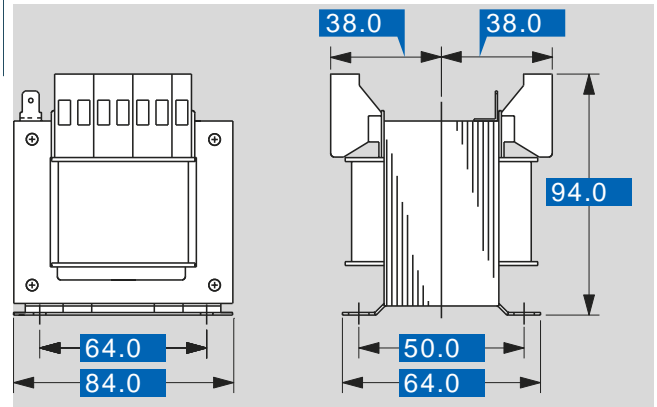

Subjects to change.

Below is a list of articles with direct links to our shop Electric Automation Network where you can see:

- Quote per purchase volume in real time.
- Online documentation and datasheets of all products.
- Estimated delivery time enquiry in real time.
- Logistics systems for the shipment of materials almost anywhere in the world.
- Purchasing management, order record and tracking of shipments.

To access the product, [click on the green button.](#)

Product	Code	Reference	Product link
Universal control- and safety isolating- resp. isolating transformer PRI universal, SEC 63 - 2500 VA, 24 or 2 x 115 Vac	STU632x115	STU 63/2x115	Buy on EAN