



Automatización Eléctrica

Especialistas en Automatización

At the end of this document you will find links to products related to this catalog. You can go directly to our shop by clicking [HERE](#). [HERE](#)

Control- and safety isolating transformer STEU 63/48



Picture shows STEU 160/23

Advantages

Dual input voltage 230 and 400 Vac
Very good switch-on behaviour thanks to reduced starting currents
High performance for the volume thanks to compact design
Primary side ± 15 V tapings for voltage adjustment
Very good corrosion protection and low noise thanks to BLOCKIMPEX vacuum impregnation
Quick to cable up thanks to the use of spring-clamp terminals
Contact protected screw connection terminals complying with UVV BGV A3
Simple mounting thanks to robust metal footplate with oval slots
Up to 250 VA with combination footplate for bolted and rail mounting

Applications

As a control transformer for the electrical isolation of the input and output sides. The construction of the transformer to supply control systems according to VDE 0113 is designed.

As an isolating transformer for the safe electrical isolation of the input and output sides. The transformer may be used to set up protective separation as a protective measure in accordance with VDE 0100.

As a safety transformer for the safe electrical isolation of the input and output sides. The transformer is suitable for creating SELV and PELV circuits because of the limit on the output voltage.

Sample application

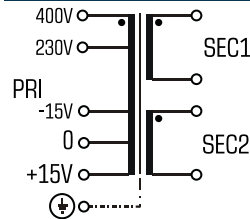

Standards



Control transformer
to: VDE 0570 Teil 2-2, DIN EN 61558-2-2, EN 61558-2-2, IEC 61558-2-2,
UL 5085-1/-2, CSA 22.2 No.66
Safety isolating transformer
to: VDE 0570 Teil 2-6, DIN EN 61558-2-6, EN 61558-2-6, IEC 61558-2-6, UL
5085-1/-2, CSA 22.2 No.66

Approvals



UL 5085-1/-2, CSA 22.2 No.66



Control- and safety isolating transformer STEU 63/48

Type		STEU 63/48
Electrical data	Input	
	Rated input voltage	230/400 Vac
	Tappings Input	±15 V
	Rated frequency	50 - 60 Hz
	Output	
	Rated output voltage	2 x 24 Vac
	Rated power VDE (DB cos phi=1)	63 VA
	Rated power VDE (KB cos phi=0.5)	175 VA
	No-load voltage (app. x factor)	1.10
	Efficiency	86 %
	Standards	
	Classification	Control- and safety isolating transformer
	Approvals	
	Approvals	cURus
	Environment	
	Ambient temperature max.	40 °C
	Type of cooling	self-cooling
	Safety and protection	
	Type	Open type
Class of Insulation System	VDE=B, UL=class 130	
Protection index	IP 00	
Safety class (prepared)	I	
Short circuit strength	non-short-circuit proof	
PRI Fusing recommendation by circuit breaker with tripping characteristic type 20 x I _{rated} related to set)		
Setting range 230 ±15 Vac	0.25 - 0.40 A	
Setting value 230 ±15 Vac	0.35 A	
Setting range 400 ±15 Vac	0.16 - 0.25 A	
Setting value 400 ±15 Vac	0.20 A	
Order numbers		
Order Number	STEU 63/48	

Type		STEU 63/48
Mechanical data	Terminal and mounting	
	Fixing method	Dual purpose base plate also for installation on mounting rails
	Fixing screws	M4
	Terminals	Spring terminal, PE 6.3 x 0.8
	Measures and weights	
	Weight	1.30 kg

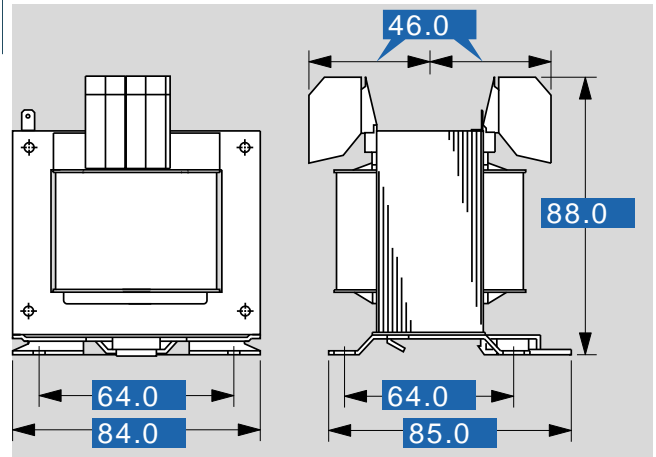



Below is a list of articles with direct links to our shop Electric Automation Network where you can see:

- Quote per purchase volume in real time.
- Online documentation and datasheets of all products.
- Estimated delivery time enquiry in real time.
- Logistics systems for the shipment of materials almost anywhere in the world.
- Purchasing management, order record and tracking of shipments.

To access the product, [click on the green button](#).

Product	Code	Reference	Product link
Control- and safety isolating- resp. isolating transformer Spring clamp terminals, dual purpose foot plate, PRI 230 and 400 Vac, SEC 63 - 2500 VA, 2 x 12 - 2 x 115 Vac	STEU6348	STEU 63/48	Buy on EAN