



Automatización Eléctrica

Especialistas en Automatización

At the end of this document you will find links to products related to this catalog. You can go directly to our shop by clicking [HERE](#). [HERE](#)

Control- and isolating transformer ST 250/4/23



Picture shows ST 160/23-23

Advantages

- Very good switch-on behaviour thanks to reduced starting currents
- High performance for the volume thanks to compact design
- Primary side $\pm 5\%$ tapings for voltage adjustment
- Very good corrosion protection and low noise thanks to BLOCKIMPEX vacuum impregnation
- Contact protected screw connection terminals complying with UVV BGV A3
- Simple mounting thanks to robust metal footplate with oval slots

Applications

As a control transformer for the electrical isolation of the input and output sides. The construction of the transformer to supply control systems according to VDE 0113 is designed.

As an isolating transformer for the safe electrical isolation of the input and output sides. The transformer may be used to set up protective separation as a protective measure in accordance with VDE 0100.

As a safety isolating transformer for the safe electrical isolation of the input and output sides. The transformer is suitable for creating SELV and PELV circuits because of the limit on the output voltage.

Sample application

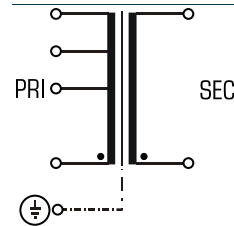

Standards



Control transformer
to: VDE 0570 Teil 2-2, DIN EN 61558-2-2, EN 61558-2-2, IEC 61558-2-2,
UL 5085-1/-2, CSA 22.2 No.66
Isolating transformer
to: VDE 0570 Part 2-4, DIN EN 61558-2-4, EN 61558-2-4, IEC 61558-2-4,
UL 5085-1/-2, CSA 22.2 No.66

Approvals



ENEC 10 (VDE), UL 5085-1/-2, CSA 22.2 No.66



Control- and isolating transformer ST 250/4/23

Type		ST 250/4/23
Electrical data	Input	
	Rated input voltage	400 Vac
	Tappings Input	±5 %
	Rated frequency	50 - 60 Hz
	Output	
	Rated output voltage	230 Vac
	Rated power VDE (DB cos phi=1)	250 VA
	Rated power VDE (KB cos phi=0.5)	555 VA
	No-load voltage (app. x factor)	1.08
	Efficiency	90 %
	Standards	
	Classification	Control- and isolating transformer
	Approvals	cURus, ENEC 10 (VDE)
	Environment	
	Ambient temperature max.	40 °C
	Type of cooling	self-cooling
	Safety and protection	
	Type	Open type
	Class of Insulation System	VDE-B, UL=class 105
Protection index	IP 00	
Safety class (prepared)	I	
Short circuit strength	non-short-circuit proof	
PRI Fusing recommendation by circuit breaker with tripping characteristic type 20 x I _{rated} related to set)		
Setting range	0.63 - 1.00 A	
Setting value	0.69 A	
Order numbers		
Order Number	ST 250/4/23	

Type		ST 250/4/23
Mechanical data	Terminal and mounting	
	Terminals	Screw-type terminals, PE 6.3 x 0.8
	Fixing method	Base plate
	Fixing screws	M5
	Measures and weights	
	Weight	3.50 kg

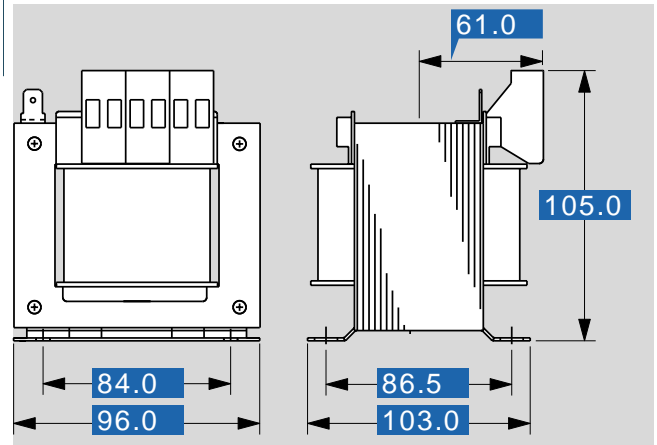



Automatización Eléctrica
Especialistas en Automatización

Below is a list of articles with direct links to our shop Electric Automation Network where you can see:

- Quote per purchase volume in real time.
- Online documentation and datasheets of all products.
- Estimated delivery time enquiry in real time.
- Logistics systems for the shipment of materials almost anywhere in the world.
- Purchasing management, order record and tracking of shipments.

To access the product, [click on the green button](#).

Product	Code	Reference	Product link
Control- and safety isolating- resp. isolating transformer PRI 110 - 690 Vac SEC 20 - 2500 VA, 12 - 230 V	ST250423	ST 250/4/23	Buy on EAN