



Automatización Eléctrica

Especialistas en Automatización

At the end of this document you will find links to products related to this catalog. You can go directly to our shop by clicking [HERE](#). [HERE](#)

Three-phase, non stabilised DC power supply DNC 24-15 C



Picture shows DNC 24-10

Advantages

Unsusceptible to voltage surges or transients
High overload capacity
DC OK signalling via LEDs
Capacitor accessories
Very good corrosion protection and low noise thanks to BLOCKIMPEX vacuum impregnation
Impulse loading MKT-capacitors
Varistor wiring
Contact protected screw connection terminals complying with UVV BGV A3

Applications

Rugged DC power supply for harsh industrial applications.

Sample application

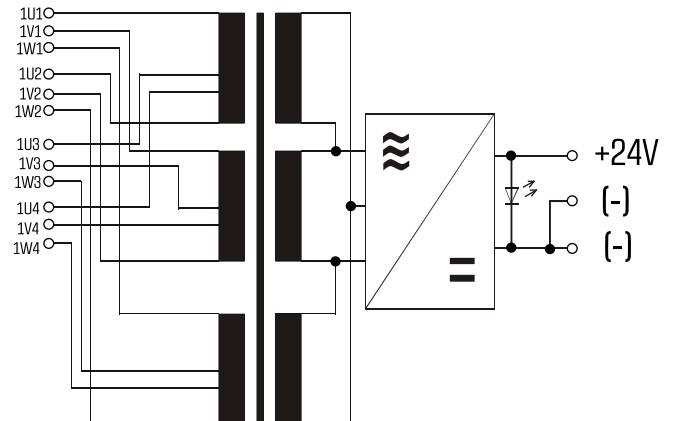

Standards



Non-stabilised dc power supply / Safety isolating transformer to VDE 0570 part 2-6, EN 61558-2-6, IEC 61558-2-6, UL 1012

Approvals



UL 5085-1/-2, CSA 22.2 No.66



Three-phase, non stabilised DC power supply DNC 24-15 C

Type		DNC 24-15 C
Electrical data	Input	
	Input rated voltage	Delta-connection: 3x219 Vac/230 Vac/241 Vac Star-connection: 3x380 Vac/400 Vac/420 Vac
	Rated frequency	50 - 60 Hz
	Output	
	Output rated voltage	24 Vdc
	Power	360.00 W
	Output rated current	15.00 A
	Ripple factor	typ. 2 %
	Approvals	
	Approvals	cURus (transformer only)
Environment		
Ambient temperature max.	+60 °C	
Type of cooling	self-cooling	
Safety and protection		
Type	Open type	
Class of Insulation System	VDE=B, UL=class 130	
Protection index	IP 00	
Safety class (prepared)	I	
Short circuit strength	non-short-circuit proof	
Order numbers		
Order Number	DNC 24-15 C	

Type		DNC 24-15 C
Mechanical data	Terminal and mounting	
	Terminals	Screw-type terminals
	Fixing method	Base plate
	Fixing screws	M5
	Measures and weights	
	Weight	6.10 kg

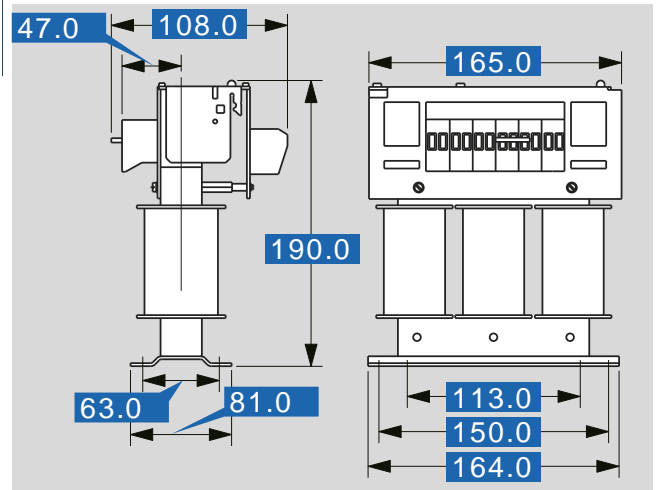



Automatización Eléctrica
Especialistas en Automatización

Below is a list of articles with direct links to our shop Electric Automation Network where you can see:

- Quote per purchase volume in real time.
- Online documentation and datasheets of all products.
- Estimated delivery time enquiry in real time.
- Logistics systems for the shipment of materials almost anywhere in the world.
- Purchasing management, order record and tracking of shipments.

To access the product, [click on the green button](#).

Product	Code	Reference	Product link
Three-phase, non stabilised DC power supply PRI multiple voltage, SEC 5 - 50 A, 24 Vdc	DNC2415C	DNC 24-15 C	Buy on EAN