



Electric Automation
Automation specialists

Reference: Acc. E2.2/E6.2
Code: 1SDA073814R1

KLP-S Pos.lock N.20006 E2.2..E6.2 2Key

Buy it at Electric Automation Network

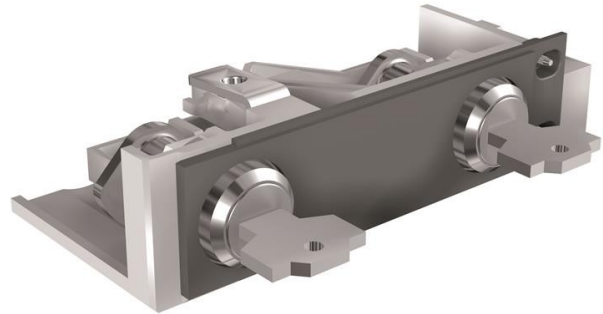

KEY LOCK WITH SAME KEYS N.20006 IN CONNECTED-ISOLATED POSITION 2a KEY
E2.2...E6.2

Ordering

EAN:	8015644777470
Minimum Order Quantity:	1 piece
Customs Tariff Number:	85389099

Container Information

Package Level 1 EAN:	8015644777470
----------------------	---------------

Additional Information

Product Main Type:	Accessories for Emax 2
Product Name:	Accessory
Product Type:	ACC
Standards:	IEC
Suitable For:	E2.2 E4.2 E6.2
Suitable for Product Class:	SACE Emax 2

Certificates and Declarations (Document Number)

Data Sheet, Technical Information:	1SDC200023D0204
------------------------------------	-----------------

Declaration of Conformity - CE:

1SDL000165R0020
1SDL000165R0021
1SDL000165R0022

Classifications

Object Classification Code:

Q