



Automation  
Industrial applications  
Residential and Commercial

# CATALOGUE



		Series	
	Industrial and PCB relays (EMR/SSR)	30, 32, 34, 36, 40, 41, 43, 45, 46, 55, 56, 60, 62, 65, 66, 67, 68, RB, RR, 99	A
	Relay interface modules (EMR/SSR) Interface modules	38, 39, 48, 4C, 58 19	B
	Relays with forcibly guided contacts	50, 75	C
	Power solid state relays (SSR)	77	D
	Monitoring relays Power analyzer products Energy meters Surge Protection Devices (SPD)	70, 72 6M 7E, 7M 7P	E
	Switch mode power supplies	78	F
	Panel thermostats Filter fans Panel heaters LED panel light Power outlets for electrical enclosures Distributions block	7T 7F 7H 7L 7U 9D	G
	OPTA - Programmable Logic Relays (PLRs)	8A	H
	Modular and plug-in timers	80, 81, 83, 84, 85, 86, 88, 93	I
	Light dependent relays Time switches Electronic staircase timers Dimmers Movement detector LUMOS - LED recessed emergency light	10, 11 12 14 15 18 1L	J
	Electronic step relays Mechanical step relays	13 20, 26, 27	K
	Modular contactors Modular monostable relays	22	L
	Chronothermostats and Room thermostats	1C 1T	M
	Comfort living YESLY Systems KNX	13, 15, 1Y 15, 18, 19, 78, 1K	N



# Subminiature DIL relays 2 A

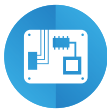

Electronic  
circuit boards



Hi-Fi systems



Printers



Toys



Medical and  
dentistry



Hoists and  
cranes



Door and  
gate openers

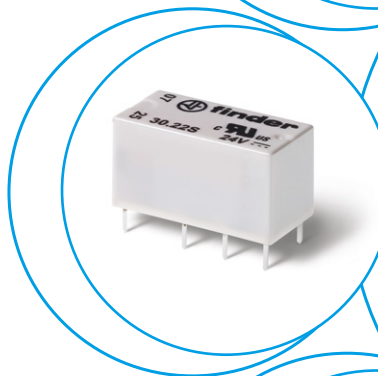



**Printed circuit mount  
2 A signal relay**

- 2 Pole changeover contacts Low level switching capability
- Subminiature - industry standard DIL package
- Sensitive DC coil - 200 mW
- Wash tight: RT III
- Cadmium Free contact material

**30.22**



- Low coil power
- Au clad contacts
- PCB mount

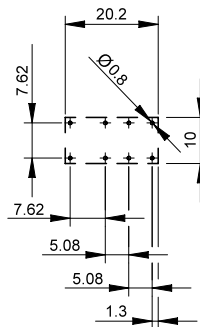
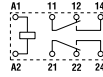

Copper side view

For outline drawing see page 5

**Contact specification**

Contact configuration		2 CO (DPDT)
Rated current/Maximum peak current	A	2/3
Rated voltage/ Maximum switching voltage	V AC	125/250
Rated load AC1	VA	125
Rated load AC15 (230 V AC)	VA	25
Single phase motor rating (230 V AC)	kW	—
Breaking capacity DC1: 24/110/220 V	A	2/0.3/—
Minimum switching load	mW (V/mA)	10 (0.1/10)
Standard contact material		AgNi + Au

**Coil specification**

Nominal voltage ( $U_N$ )	V AC (50/60 Hz)	—
	V DC	5 - 6 - 9 - 12 - 24 - 48
Rated power AC/DC	VA (50 Hz)/W	—/0.2
Operating range	AC	—
	DC	See table page 5
Holding voltage	AC/DC	—/0.35 $U_N$
Must drop-out voltage	AC/DC	—/0.05 $U_N$

**Technical data**

Mechanical life AC/DC	cycles	—/2 · 10 <sup>6</sup>
Electrical life at rated load AC1	cycles	100 · 10 <sup>3</sup>
Operate/release time	ms	6/4
Insulation between coil and contacts (1.2/50 $\mu$ s)	kV	1.5
Dielectric strength between open contacts	V AC	750
Ambient temperature range	°C	−40...+85
Environmental protection		RT III

**Approvals** (according to type)



## Ordering information

Example: 30 series PCB relay, 2 CO (DPDT) - 2 A contacts, 12 V sensitive DC coil.

A

3 0 . 2 2 . 7 . 0 1 2 . 0 . 0 . 2 . 0

A      B      C      D

**Series**  
3 0 = 30 series

**Type**  
2 = PCB mount

**No. of poles**  
2 = 2 pole, 2 A

**Coil version**  
7 = Sensitive DC

**Coil voltage**  
See coil specifications

**A: Contact material**  
0 = Standard  
AgNi + Au

**B: Contact circuit**  
0 = CO (DPDT)

**D: Special versions**  
0 = Wash tight (RT III)

**C: Options**  
2 = None

## Technical data

Insulation according to EN 61810-1		
Nominal voltage of supply system	V AC	125/250
Rated insulation voltage	V AC	250
Pollution degrees		1
Insulation between coil and contact set		
Type of insulation		Basic
Overvoltage category		I
Rated impulse voltage	kV (1.2/50 µs)	1.5
Dielectric strength	V AC	1000
Insulation between adjacent contacts		
Type of insulation		Basic
Overvoltage category		I
Rated impulse voltage	kV (1.2/50 µs)	1.5
Dielectric strength	V AC	1500
Insulation between open contacts		
Type of disconnection		Micro-disconnection
Dielectric strength	V AC/kV (1.2/50 µs)	750/1
Other data		
Bounce time: NO/NC	ms	2/6
Vibration resistance (10...38)Hz:	g	10
Shock resistance	g	10
Power lost to the environment	without contact current W	0.2
	with rated current W	0.4
Recommended distance between relays mounted on PCB	mm	≥ 5



A

## Contact specification

F 30 - Electrical life (AC1) v contact current (125 V)

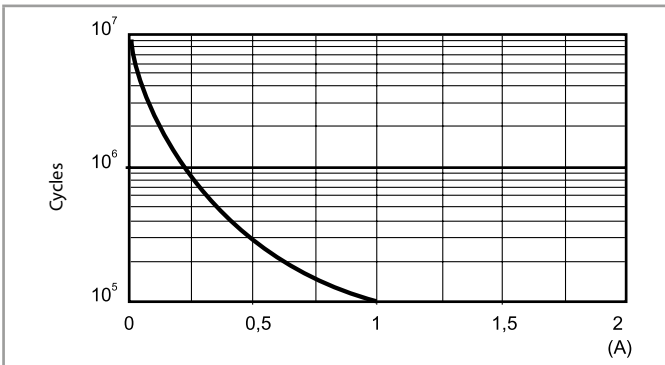

Note:

The rated current of 2 A corresponds to the limiting continuous current.

## Coil specifications

DC coil data - 0.2 W sensitive

Nominal voltage $U_N$	Coil code	Operating range		Resistance $R$	Rated coil consumption $I$ at $U_N$
		$U_{min}$	$U_{max}$		
V		V	V	$\Omega$	mA
5	7.005	3.7	7.5	125	40
6	7.006	4.5	9	180	33
9	7.009	6.7	13.5	405	22
12	7.012	8.4	18	720	16
24	7.024	16.8	36	2880	8.3
48	7.048	33.6	72	11520	4.8

R 30 - DC coil operating range v ambient temperature

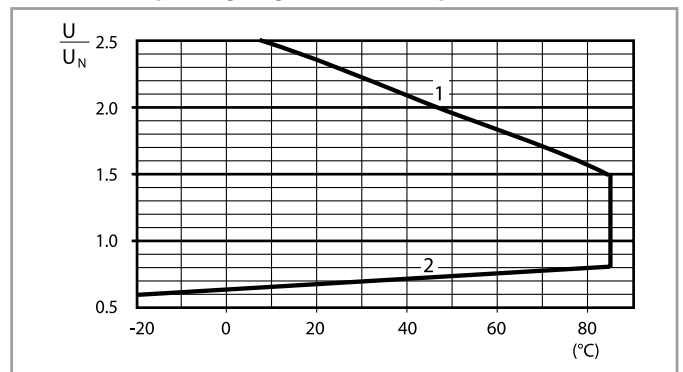

1 - Max. permitted coil voltage.

2 - Min. pick-up voltage with coil at ambient temperature.

## Outline drawing

Type 30.22

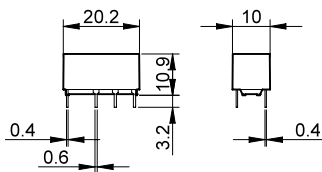



# Subminiature PCB relays 6 A



Copiers



Hi-Fi systems



Washing  
machines



Control  
systems



Electronic kits



Medical and  
dentistry

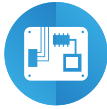

Electronic circuit  
boards



Programmable  
controllers

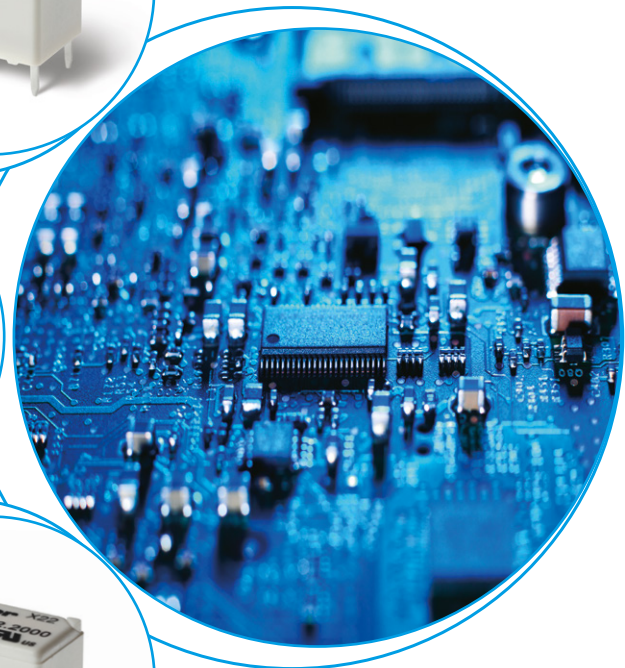
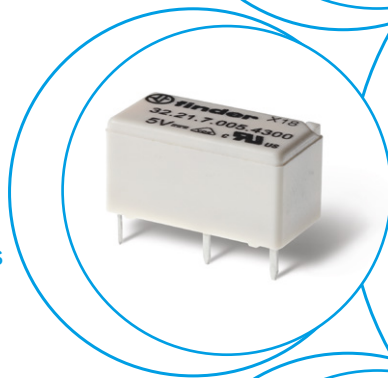





**Printed circuit mount 6 A relay**

- 1 Pole changeover contacts or 1 Pole normally open contact
- Subminiature, low profile package
- Sensitive DC coil - 200 mW
- Wash tight: RT III
- Cadmium Free contacts

**32.21-4000**



- 1 CO (SPDT), 6 A
- Low coil power
- PCB mount

**32.21-4300**



- 1 NO (SPST-NO), 6 A
- Low coil power
- PCB mount

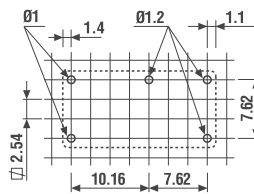
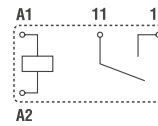
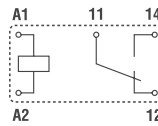

Copper side view

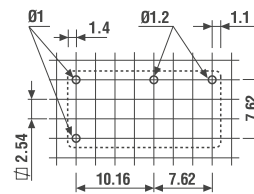

Copper side view

For outline drawing see page 5

**Contact specification**

Contact configuration		1 CO (SPDT)	1 NO (SPST-NO)
Rated current/Maximum peak current	A	6/15	6/15
Rated voltage/ Maximum switching voltage	V AC	250/400	250/400
Rated load AC1	VA	1500	1500
Rated load AC15 (230 V AC)	VA	250	250
Single phase motor rating (230 V AC)	kW	0.185	0.185
Breaking capacity DC1: 24/110/220 V	A	3/0.35/0.2	3/0.35/0.2
Minimum switching load	mW (V/mA)	500 (10/5)	500 (10/5)
Standard contact material		AgSnO <sub>2</sub>	AgSnO <sub>2</sub>

**Coil specification**

Nominal voltage (U <sub>N</sub> )	V AC (50/60 Hz)	—	—
	V DC	5 - 12 - 24 - 48	5 - 12 - 24 - 48
Rated power AC/DC	VA (50 Hz)/W	—/0.2	—/0.2
Operating range	AC	—	—
	DC	(0.78...1.5)U <sub>N</sub>	(0.78...1.5)U <sub>N</sub>
Holding voltage	AC/DC	—/0.4 U <sub>N</sub>	—/0.4 U <sub>N</sub>
Must drop-out voltage	AC/DC	—/0.1 U <sub>N</sub>	—/0.1 U <sub>N</sub>

**Technical data**

Mechanical life AC/DC	cycles	—/20 · 10 <sup>6</sup>	—/20 · 10 <sup>6</sup>
Electrical life at rated load AC1	cycles	50 · 10 <sup>3</sup>	50 · 10 <sup>3</sup>
Operate/release time	ms	6/4	6/2
Insulation between coil and contacts (1.2/50 μs)	kV	6	6
Dielectric strength between open contacts	V AC	1000	1000
Ambient temperature range	°C	-40...+85	-40...+85
Environmental protection		RT III	RT III

**Approvals** (according to type)



## Ordering information

Example: 32 series PCB, 1 NO (SPDT-NO) - 6 A contacts, 24 V sensitive DC coil.

A

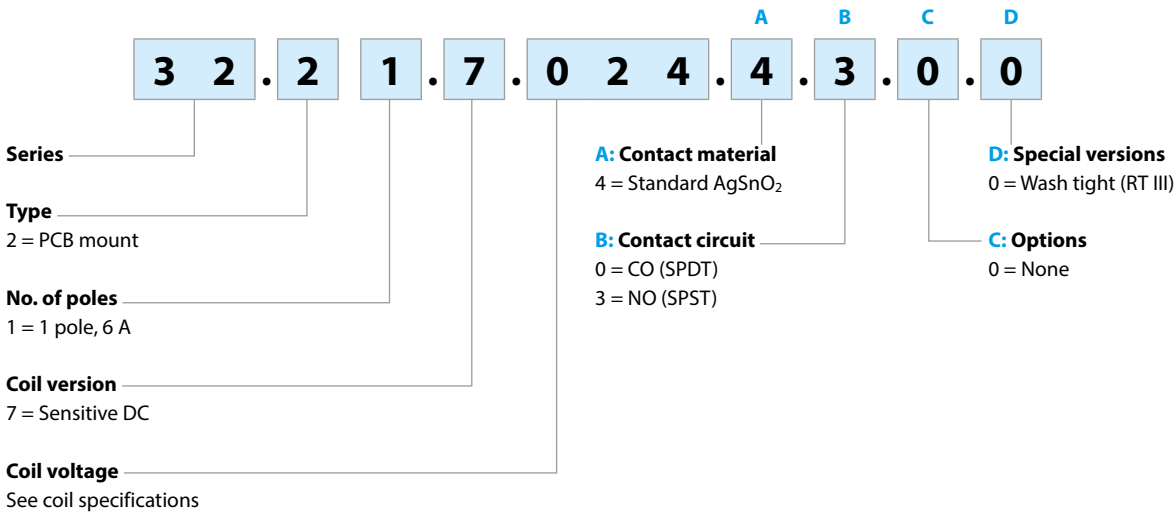

**Selecting features and options: only combinations in the same row are possible.**

Preferred selections for best availability are shown in **bold**.

Type	Coil version	A	B	C	D
32.21	sens. DC	<b>4</b>	<b>0-3</b>	<b>0</b>	<b>0</b>

## Technical data

### Insulation according to EN 61810-1

Nominal voltage of supply system	V AC	230/400
Rated insulation voltage	V AC	250
Pollution degree		2

### Insulation between coil and contact set

Type of insulation		Reinforced
Overvoltage category		III
Rated impulse voltage	kV (1.2/50 µs)	6
Dielectric strength	V AC	4000

### Insulation between open contacts

Type of disconnection		Micro-disconnection
Dielectric strength	V AC/kV (1.2/50 µs)	1000/1.5

### Insulation between coil terminals

Rated impulse voltage (surge) differential mode (according to EN 61000-4-5)	kV (1.2/50 µs)	2
---	----------------	---

### Other data

Bounce time: NO/NC	ms	2/10 (changeover)	2/— (normally open)
Vibration resistance (5...55)Hz: NO/NC	g	10/10 (changeover)	10/— (normally open)
Shock resistance	g	20	
Power lost to the environment	without contact current	W	0.2
	with rated current	W	0.5
Recommended distance between relays mounted on PCB	mm	≥ 5	

## Contact specification

F 32 - Electrical life (AC) v contact current

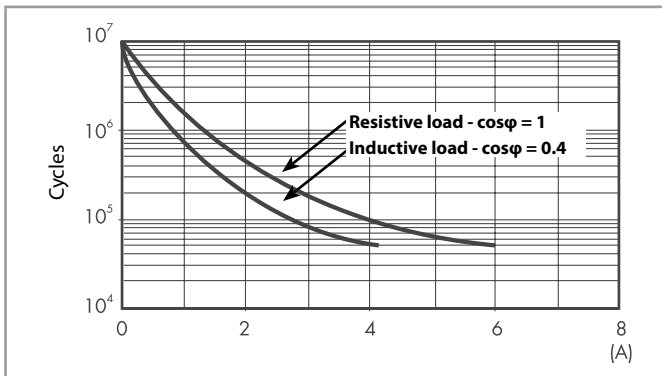

H 32 - Maximum DC1 breaking capacity

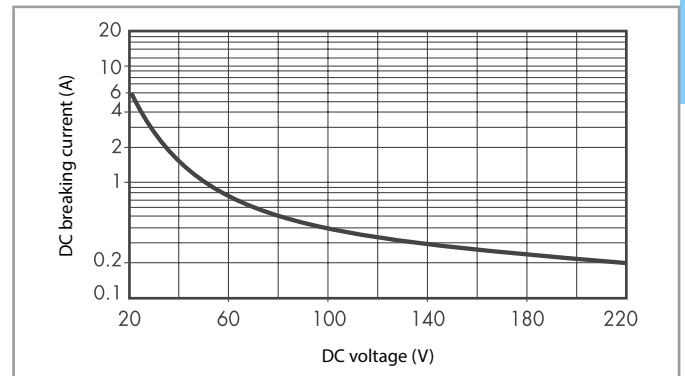

- When switching a resistive load (DC1) having voltage and current values under the curve, an electrical life of  $\geq 50 \cdot 10^3$  can be expected.
  - In the case of DC13 loads, the connection of a diode in parallel with the load will permit a similar electrical life as for a DC1 load.
- Note: the release time for the load will be increased.

## Coil specifications

DC coil data - 0.2 W sensitive

Nominal voltage $U_N$	Coil code	Operating range		Resistance $R$	Rated coil consumption $I$ at $U_N$
		$U_{min}$	$U_{max}$		
V		V	V	$\Omega$	mA
5	7.005	3.9	7.5	125	40
12	7.012	9.4	18	720	16
24	7.024	18.7	36	2880	8.3
48	7.048	37.4	72	11520	4

R 32 - DC coil operating range v ambient temperature

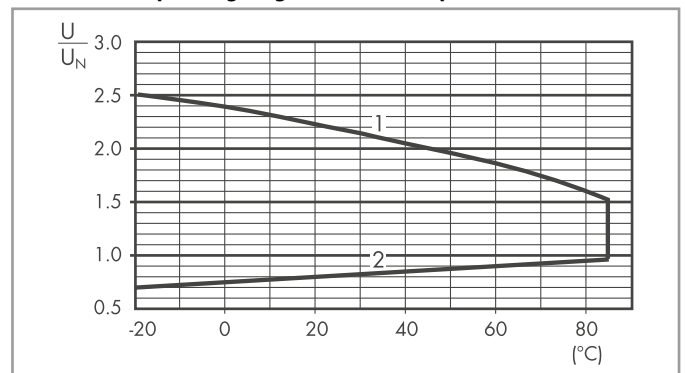

- 1 - Max. permitted coil voltage.
- 2 - Min. pick-up voltage with coil at ambient temperature.

## Outline drawing

Types 32.21-4000/4300

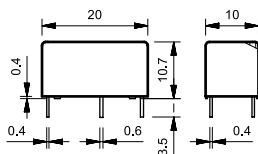





# Ultra-slim PCB Relays (EMR or SSR) 0.1 - 0.2 - 2 - 6 A



Bottling plant



Packaging machines



Labelling machines



Road / tunnel lighting



Burners, boilers and furnaces



Timers and lighting controls

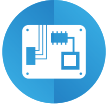

Electronic circuit boards



Programmable controllers

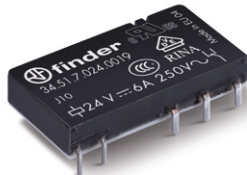
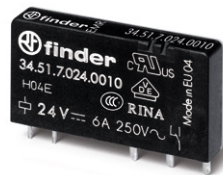



**Ultra-slim 1 Pole - 6 A relay**

**Printed circuit mount**

- direct or via PCB socket (according to type)

**35 mm rail mount**

- via screw, screwless or push-in terminal sockets

- 1 Pole changeover contacts or 1 Pole normally open contact
- Ultra slim (5 mm), package
- Sensitive DC coil - 170 mW (Dual AC/DC coil drive possible using 93 series sockets)
- UL Listing (certain relay/socket combinations)
- Cadmium Free contact materials
- 8/8 mm clearance/creepage distance
- 6 kV (1.2/50 μs) insulation, coil-contacts

FOR UL RATINGS SEE:

"General technical information" page V

For outline drawing see page 9

**Contact specification**

Contact configuration

**34.51-xx10**



- 5 mm wide
- Low coil power
- PCB or 93 series sockets
- Contact AgNi

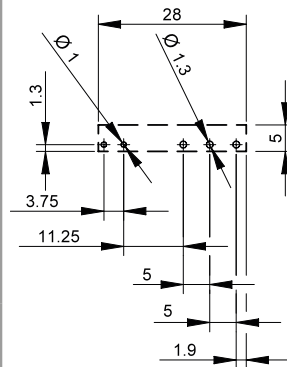
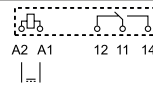

Copper side view

**34.51-5x10**



- 5 mm wide
- Low coil power
- PCB or 93 series sockets
- Contact AgNi + Au

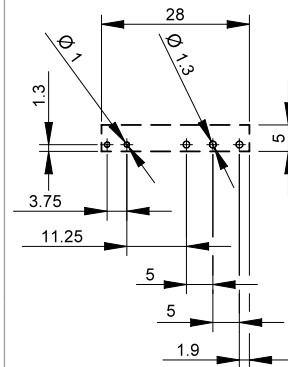
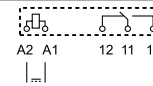

Copper side view

**34.51-0000**



- 5 mm wide
- Low coil power
- PCB only
- Contact AgSnO<sub>2</sub>

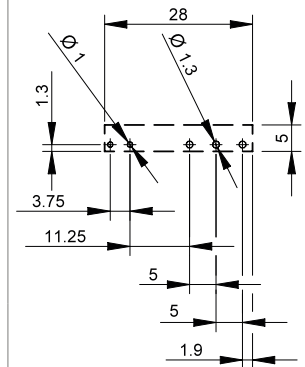
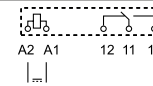

Copper side view

**Coil specification**

Nominal voltage (U<sub>N</sub>)

V AC (50/60 Hz)

—

—

—

V DC

5 - 12 - 24 - 48 - 60

5 - 12 - 24 - 48 - 60

12 - 24

Rated power AC/DC

VA (50 Hz)/W

—/0.17

—/0.17

—/0.17

Operating range

AC

—

—

—

DC

(0.7...1.5)U<sub>N</sub>

(0.7...1.5)U<sub>N</sub>

(0.7...1.5)U<sub>N</sub>

Holding voltage

AC/DC

—/0.4 U<sub>N</sub>

—/0.4 U<sub>N</sub>

—/0.4 U<sub>N</sub>

Must drop-out voltage

AC/DC

—/0.05 U<sub>N</sub>

—/0.05 U<sub>N</sub>

—/0.05 U<sub>N</sub>

**Technical data**

Mechanical life AC/DC

cycles

—/10 · 10<sup>6</sup>

—/10 · 10<sup>6</sup>

—/10 · 10<sup>6</sup>

Electrical life at rated load AC1

cycles

60 · 10<sup>3</sup>

60 · 10<sup>3</sup>

60 · 10<sup>3</sup>

Operate/release time

ms

5/3

5/3

5/3

Insulation between coil and contacts (1.2/50 μs)

kV

6 (8 mm)

6 (8 mm)

6 (8 mm)

Dielectric strength between open contacts

V AC

1000

1000

1000

Ambient temperature range

°C

−40...+85

−40...+85

−40...+85

Environmental protection

RT II

RT II

RT III

**Approvals** (according to type)



**Ultra-slim Solid State Relays**

**Printed circuit mount**

- direct or via PCB socket

**35 mm rail mount**

- via screw, screwless or push-in terminal sockets

- Single circuit output switching options
  - 6 A, 24 V DC
  - 2 A, 240 V AC
- Silent, high speed switching with long electrical life
- Ultra slim (5 mm), package
- Sensitive DC Input circuits (Dual AC/DC input drive possible using 93 series sockets)
- UL Listing (certain relay/socket combinations)
- Wash tight: RT III
- 3000 V AC insulation, input-output

**NEW 34.81.7.xxx.9024**



- 6 A, 24 V DC output switching
- PCB or 93 series sockets

**34.81.7.xxx.8240**



- 2 A, 240 V AC output switching
- Zero crossing switching
- PCB or 93 series sockets

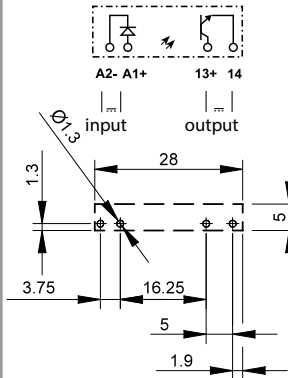

Copper side view

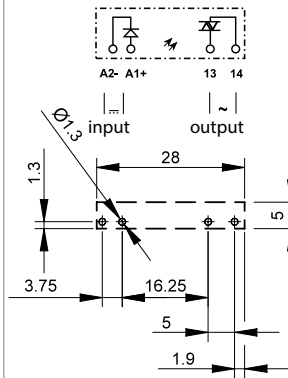

Copper side view

For outline drawing see page 9

**Output circuit**

Contact configuration		1 NO (SPST-NO)	1 NO (SPST-NO)
Rated current/ Maximum peak current (10 ms)	A	6/50	2/80
Rated switching voltage	V	24 DC	240 AC (50/60 Hz)
Switching voltage range	V	(1.5...33)DC	(12...275)AC
Maximum blocking voltage	V	33	—
Repetitive peak off-state voltage	V <sub>pk</sub>	—	800
Rated load DC13	W	36	—
Rated load AC15	VA	—	300
Minimum switching current	mA	1	35
Max. "OFF-state" leakage current	mA	0.001	1.5
Max. "ON-state" voltage drop	V	0.4	1.6

**Supply specification**

Nominal voltage (U <sub>N</sub> )	V DC	5	12	24	60	5	12	24	60
Rated power	W	0.035	0.085	0.17	0.21	0.06	0.085	0.17	0.21
Operating range	V DC	35...12	8...17	16...30	35...72	35...10	8...17	16...30	35...72
Control current	mA	7	7	7	3.5	12	7	7	3.5
Release voltage	V DC	4	4	10	20	1	4	10	20

**Technical data**

Electrical life at rated load	cycles	> 10 <sup>6</sup>				> 10 <sup>6</sup>			
Operate/release time	ms	0.02/0.2				11/11			
Insulation between input and output (1.2/50μs)	kV	4				4			
Ambient temperature range	°C	-20...+70*				-20...+50*			
Environmental protection		RT III				RT III			

**Approvals** (according to type)



\* Note: all technical data relates to using the relay directly on PCB or PCB socket type 93.11.  
If the relay is used with 35 mm rail socket types 93.01 and 93.51, refer to the technical data of 38 Series; if used with types 93.60, 93.61, 93.62, 93.63, 93.64, 93.65, 93.66, 93.67, 93.68 and 93.69, refer to the technical data of the MasterINTERFACE 39 Series. See L34 diagrams page 8



**Ultra-slim Solid State Relays**

**Printed circuit mount**

- direct or via PCB socket

**35 mm rail mount**

- via screw, screwless or push-in terminal sockets

- Single circuit output switching options
  - 0.1 A, 48 V DC
  - 0.2 A, 220 V DC
- Silent, high speed switching with long electrical life
- Ultra slim (5 mm), package
- Sensitive DC Input circuits (Dual AC/DC input drive possible using 93 series sockets)
- UL Listing (certain relay/socket combinations)
- Wash tight: RT III
- 3000 V AC insulation, input-output

**34.81.7.xxx.7048**

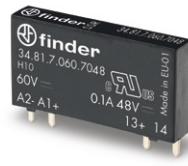

- 100 mA, 48 V DC output switching
- PCB or 93 series sockets

**NEW 34.81.7.xxx.7220**



- 200 mA, 110/220 V DC output switching
- PCB or 93 series sockets

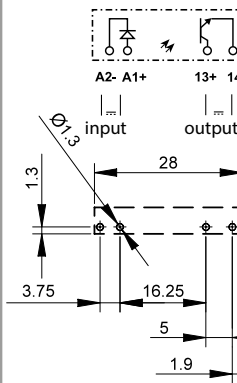

Copper side view

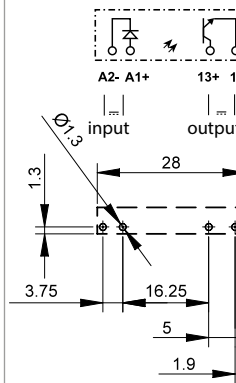

Copper side view

For outline drawing see page 9

**Output circuit**

Contact configuration		1 NO (SPST-NO)	1 NO (SPST-NO)
Rated current/ Maximum peak current (10 ms)	A	0.1/0.5	0.2/10
Rated switching voltage	V	48 DC	220 DC
Switching voltage range	V	(1.5...53)DC	(90...256)DC
Maximum blocking voltage	V	53	256
Rated load DC13	W	2.4	44
Minimum switching current	mA	0.05	0.05
Max. "OFF-state" leakage current	mA	0.001	0.001
Max. "ON-state" voltage drop	V	1	0.4

**Supply specification**

Nominal voltage (U <sub>N</sub> )	V DC	24	60	24	60
Rated power	W	0.17	0.21	0.17	0.21
Operating range	V DC	16...30	35...72	16...30	35...72
Control current	mA	7	3.5	7	3.5
Release voltage	V DC	10	20	10	20

**Technical data**

Electrical life at rated load	cycles	> 10 <sup>6</sup>	> 10 <sup>6</sup>
Operate/release time	ms	0.03/0.6	0.4/2.2
Insulation between input and output (1.2/50μs)	kV	4	4
Ambient temperature range	°C	-20...+70*	-20...+70*
Environmental protection		RT III	RT III

**Approvals (according to type)**



\* Note: all technical data relates to using the relay directly on PCB or PCB socket type 93.11.  
If the relay is used with 35 mm rail socket types 93.01 and 93.51, refer to the technical data of 38 Series; if used with types 93.60, 93.61, 93.62, 93.63, 93.64, 93.65, 93.66, 93.67, 93.68 and 93.69, refer to the technical data of the MasterINTERFACE 39 Series.

## Ordering information

### Electromechanical relay (EMR)

Example: 34 series Ultra-Slim electromechanical relay, 1 CO (SPDT) 6 A contacts, 24 V sensitive DC coil.

**A**

3 4 . 5 1 . 7 . 0 2 4 . 0 0 1 0

**Series** ——— 3 4

**Type** ——— 5  
5 = Electromechanical type

**No. of poles** ——— 1  
1 = 1 pole, 6 A

**Coil version** ——— 7  
7 = Sensitive DC

**Coil voltage** ——— 24  
See coil specifications

**A: Contact material**  
0 = Standard AgNi,  
Standard AgSnO<sub>2</sub>  
(for 34.51-0000 only)  
4 = AgSnO<sub>2</sub>  
5 = AgNi + Au

**B: Contact circuit**  
0 = CO (SPDT)  
3 = NO (SPST)

**C: Options**  
0 = Wash tight RT III  
1 = Flux proof RT II

**D: Special versions**  
0 = Standard version  
9 = Flat version

Selecting features and options: only combinations in the same row are possible.

Preferred selections for best availability are shown in **bold**.

Type	Coil version	A	B	C	D
34.51	sens. DC	<b>0</b> - 4 - 5	<b>0</b> - 3	<b>0</b> - 1	<b>0</b>
34.51	sens. DC	0 - 4 - 5	0	1	9

### Solid state relay (SSR)

Example: 34 series solid state relay, 6 A 24 V DC output, 24 V DC supply.

3 4 . 8 1 . 7 . 0 2 4 . 9 0 2 4

**Series** ——— 3 4

**Type** ——— 8  
8 = SSR type

**Output** ——— 1  
1 = 1 NO (SPST-NO)

**Input circuit** ——— 7  
See input specifications

**Output circuit**  
9024 = 6 A - 24 V DC  
7048 = 0.1 A - 48 V DC  
7220 = 0.2 A - 220 V DC  
8240 = 2 A - 240 V AC

## Flat pack version

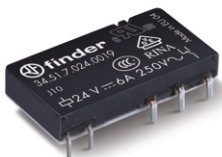

Option = 34.51.7xxx.x019

Environmental protection RT I

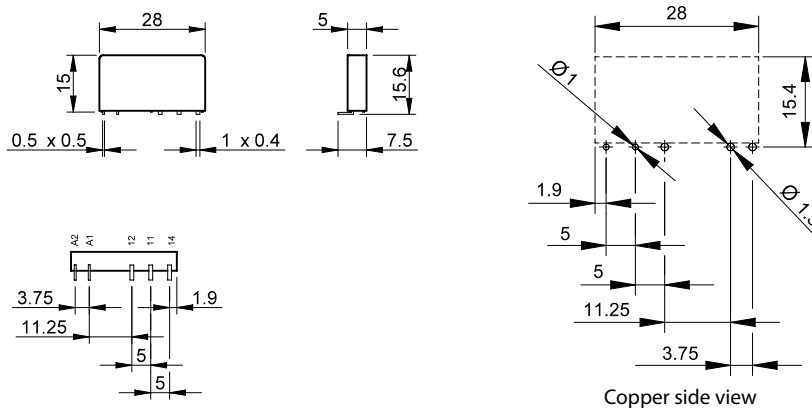

## Electromechanical relay

A

### Technical data

#### Insulation according to EN 61810-1

Nominal voltage of supply system	V AC	230/400	
Rated insulation voltage	V AC	250	400
Pollution degree		3	2

#### Insulation between coil and contact set

Type of insulation		Reinforced
Overvoltage category		III
Rated impulse voltage	kV (1.2/50 $\mu$ s)	6
Dielectric strength	V AC	4000

#### Insulation between open contacts

Type of disconnection		Micro-disconnection
Dielectric strength	V AC/kV (1.2/50 $\mu$ s)	1000/1.5

#### Insulation between coil terminals

Rated impulse voltage (surge) differential mode (according to EN 61000-4-5)	kV (1.2/50 $\mu$ s)	2
---	---------------------	---

#### Other data

Bounce time: NO/NC	ms	1/6	
Vibration resistance (5...55)Hz: NO/NC	g	10/5	
Shock resistance	g	20/14	
Power lost to the environment	without contact current	W	0.2
	with rated current	W	0.5
Recommended distance between relays mounted on PCB	mm	$\geq 5$	

### Contact specification

#### F 34 - Electrical life (AC) v contact current

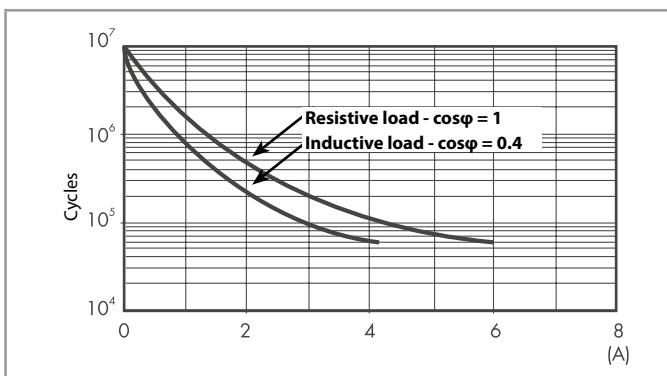

#### H 34 - Maximum DC1 breaking capacity

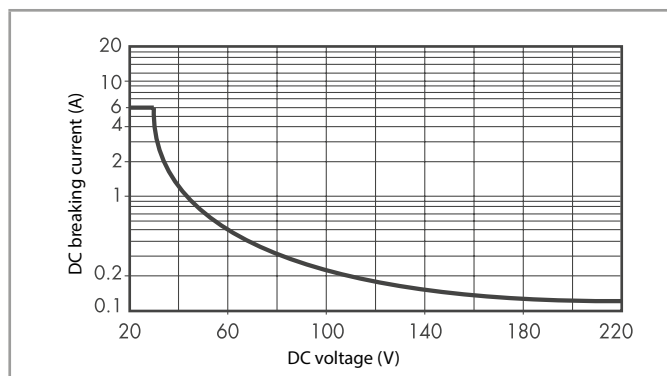

- When switching a resistive load (DC1) having voltage and current values under the curve, an electrical life of  $\geq 60 \cdot 10^3$  can be expected.
- In the case of DC13 loads, the connection of a diode in parallel with the load will permit a similar electrical life as for a DC1 load.  
Note: the release time for the load will be increased.

### Coil specifications

#### DC coil data

Nominal voltage	Coil code	Operating range		Resistance	Rated coil consumption
		$U_{min}$	$U_{max}$		
$U_N$		V	V	$R$	I at $U_N$
V		V	V	$\Omega$	mA
5	7.005	3.5	7.5	130	38.4
12	7.012	8.4	18	840	14.2
24	7.024	16.8	36	3350	7.1
48	7.048	33.6	72	12300	3.9
60	7.060	42	90	19700	3

#### R 34 - DC coil operating range v ambient temperature

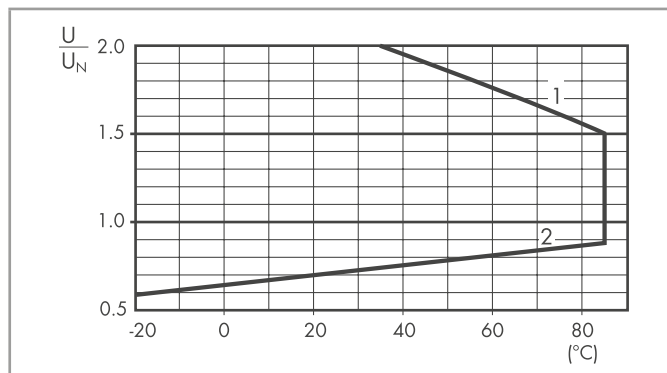

- 1 - Max. permitted coil voltage.
- 2 - Min. pick-up voltage with coil at ambient temperature.

Solid state relay

Technical data

A

<b>Insulation</b>			<b>Dielectric strength</b>	<b>Impulse (1.2/50 µs)</b>
Between input and output			3000 V AC	4 kV
<b>EMC specifications</b>		<b>Reference standard</b>		
Electrostatic discharge	contact discharge	EN 61000-4-2	4 kV	
	air discharge	EN 61000-4-2	8 kV	
Radiated electromagnetic field (80...1000 MHz)		EN 61000-4-3	10 V/m	
Fast transients on supply terminals (burst 5/50 ns, 5 and 100 kHz)		EN 61000-4-4	2 kV	
Voltage pulses on supply terminals (surge 1.2/50 µs)	common mode	EN 61000-4-5	0.7 kV	
	differential mode	EN 61000-4-5	0.7 kV*	
Radio-frequency common mode voltage (0.15...230 MHz)		EN 61000-4-6	10 V	
<b>Other data</b>				
Power lost to the environment	without output current	W	0.15	
	with rated current	W	0.4	

\* For 34.81.7.005... = 0.3 kV; for 34.81.7.012... = 0.5 kV

Input specification

Input data - DC types

Nominal voltage $U_N$ V	Input code	Operating range		Release voltage V	Impedance $\Omega$	Control current I at $U_N$ mA
		$U_{min}$ V	$U_{max}$ V			
5	7.005	3.5	12*	1	715	7*
12	7.012	8	17	4	1715	7
24	7.024	16	30	10	3430	7
60	7.060	35	72	20	17000	3.5

\* For 34.81.7.005.8240:  $U_{MAX} = 10 V$ , I @ 5 V = 12 mA

Output specification

L 34-1 - Output DC current v ambient temperature

34.81.7...9024

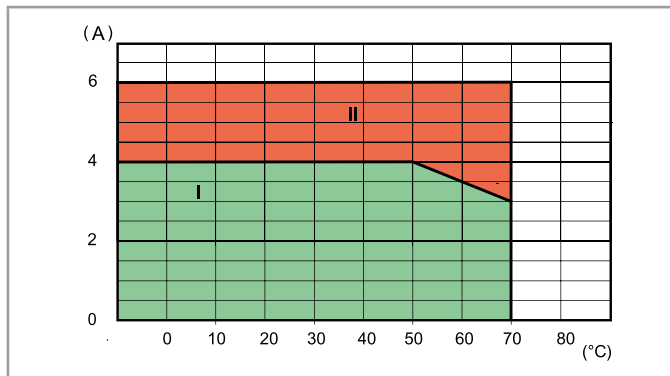

L 34 - Output AC current v ambient temperature

34.81.7...8240

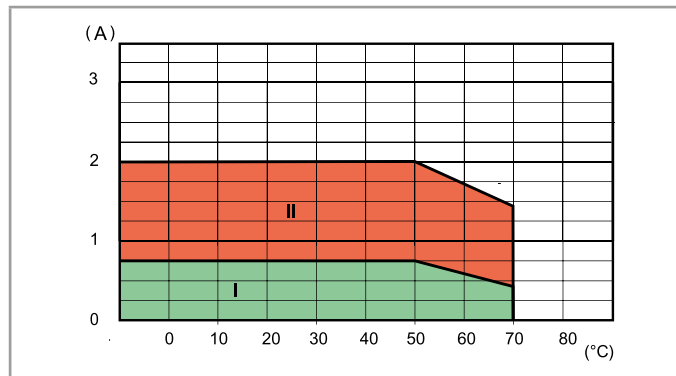

I: SSR installed on 93 series sockets as a group (without gap between sockets)

II: SSR installed individually in free air, or with a gap  $\geq 9$  mm, which implies a not significant influence from nearby components

Max recommended switching frequency (Cycles/Hour, with 50% Duty-cycle) at ambient temperature 50°C, single mounting

Load	34.81.7xxx.9024	34.81.7xxx.8240	34.81.7xxx.7048	34.81.7xxx.7220
24 V 6 A DC1	180 000	—	—	—
24 V 3 A DC L/R = 10 ms	5000	—	—	—
24 V 2 A DC L/R = 40 ms	3600	—	—	—
24 V 1 A DC L/R = 40 ms	6500	—	—	—
24 V 0.8 A DC L/R = 40 ms	9000	—	—	—
24 V 1.5 A DC L/R = 80 ms	3250	—	—	—
230 V 2 A AC1	—	60 000	—	—
230 V 1.25 A AC15	—	3600	—	—
48 V 0.1 A DC1	—	—	60 000	—
220 V 0.2 A DC1	—	—	—	60 000

### Outline drawings

Type 34.51

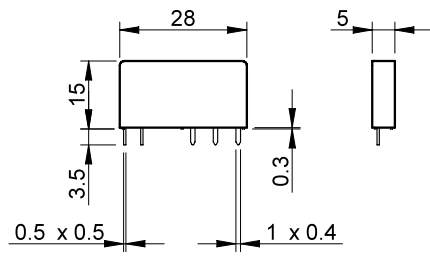

Type 34.81

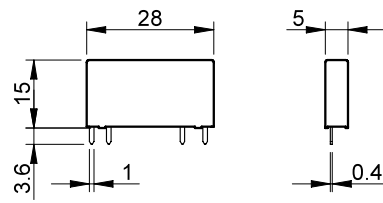

A

A

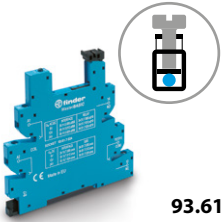

93.61

**Screw terminal socket** 35 mm rail mounting (EN 60715)

**Common features**

- Space saving 6.2 mm wide
- Connections for 16-way jumper link
- Integral coil indication and protection circuit
- Secure retention and easy ejection by plastic clip
- Dual screw head (blade+cross) terminals

For technical data and supply versions, refer to the Master **INTERFACE 39 Series** – “Relay interface module”

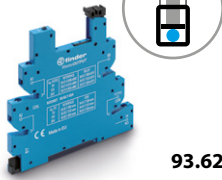

93.62

**Electromechanical Relay - EMR**

Supply voltage	Relay type	Socket type (reference with the 39 Series)				
		Master <b>BASIC</b> (39.11...)	Master <b>PLUS</b> (39.31...)	Master <b>INPUT</b> (39.41...)	Master <b>OUTPUT</b> (39.21...)	Master <b>TIMER</b> (39.81...)
6 V AC/DC	34.51.7.005.xx10	93.61.7.024	93.63.7.024	93.64.7.024	93.62.7.024	—
12 V AC/DC	34.51.7.012.xx10	93.61.7.024	93.63.7.024	93.64.7.024	93.62.7.024	93.68.0.024
24 V AC/DC	34.51.7.024.xx10	93.61.7.024	93.63.7.024	93.64.7.024	93.62.7.024	93.68.0.024
60 V AC/DC	34.51.7.060.xx10	—	93.63.7.060	—	—	—
(110...125)V AC/DC*	34.51.7.060.xx10	—	93.63.3.125	—	—	—
(220...240)V AC*	34.51.7.060.xx10	—	93.63.3.230	—	—	—
(110...125)V AC/DC	34.51.7.060.xx10	93.61.0.125	93.63.0.125	93.64.0.125	93.62.0.125	—
(24...240)V AC/DC	34.51.7.024.xx10	—	93.63.0.240	—	—	—
(220...240)V AC	34.51.7.060.xx10	93.61.8.230	93.63.8.230	93.64.8.230	93.62.8.230	—
(110...125)V DC	34.51.7.060.xx10	—	93.63.7.125	—	—	—
220 V DC	34.51.7.060.xx10	—	93.63.7.220	—	—	—

\* Leakage current suppression

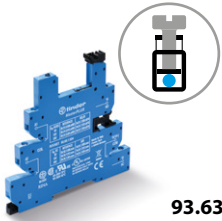

93.63

**Solid State Relay - SSR**

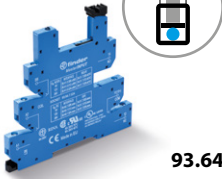

93.64

Supply voltage	Relay type	Socket type (reference with the 39 Series)				
		Master <b>BASIC</b> (39.10...)	Master <b>PLUS</b> (39.30...)	Master <b>INPUT</b> (39.40...)	Master <b>OUTPUT</b> (39.20...)	Master <b>TIMER</b> (39.80...)
12 V AC/DC	34.81.7.012.xxxx	—	—	—	—	93.68.0.024
24 V AC/DC	34.81.7.024.xxxx	—	93.63.0.024	93.64.0.024	—	93.68.0.024
(110...125)V AC/DC*	34.81.7.060.xxxx	—	93.63.3.125	—	—	—
(220...240)V AC*	34.81.7.060.xxxx	—	93.63.3.230	—	—	—
(110...125)V AC/DC	34.81.7.060.xxxx	93.61.0.125	93.63.0.125	93.64.0.125	93.62.0.125	—
(24...240)V AC/DC	34.81.7.024.xxxx	—	93.63.0.240	—	—	—
(220...240)V AC	34.81.7.060.xxxx	93.61.8.230	93.63.8.230	93.64.8.230	93.62.8.230	—
6 V DC	34.81.7.005.xxxx	93.61.7.024	93.63.7.024	93.64.7.024	93.62.7.024	—
12 V DC	34.81.7.012.xxxx	93.61.7.024	93.63.7.024	93.64.7.024	93.62.7.024	—
24 V DC	34.81.7.024.xxxx	93.61.7.024	93.63.7.024	93.64.7.024	93.62.7.024	—
60 V DC	34.81.7.060.xxxx	—	93.63.7.060	—	—	—
(110...125)V DC	34.81.7.060.xxxx	—	93.63.7.125	—	—	—
220 V DC	34.81.7.060.xxxx	—	93.63.7.220	—	—	—

\* Leakage current suppression

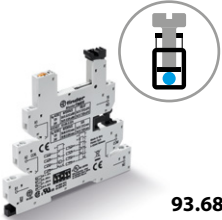

93.68

Approvals  
(according to type):



**Accessories**

16-way jumper link	093.16 (blue), 093.16.0 (black), 093.16.1 (red)
Dual-purpose plastic separator	093.60
Sheet of marker tags	060.48 and 093.48

**Technical data**

Rated values	6 A - 250 V
Dielectric strength	6 kV (1.2/50 μs) between coil and contacts
Protection category	IP 20
Ambient temperature	°C -40...+70
Screw torque	Nm 0.5
Wire strip length	mm 10
Max wire size	Solid wire and stranded wire
	mm <sup>2</sup> 1 x (0.5...2.5) / 2 x 1.5
	AWG 1 x (21...14) / 2 x 16



**Push-In terminal socket** 35 mm rail mounting (EN 60715)

**Common features**

- Space saving 6.2 mm wide
- Connections for 16-way jumper link
- Terminal doubler 093.62
- Integral coil indication and protection circuit
- Secure retention and easy ejection by plastic clip

93.60

For technical data and supply versions, refer to the Master**INTERFACE 39 Series** – “Relay interface module”



**Electromechanical Relay - EMR**

Supply voltage	Relay type	Socket type (reference with the 39 Series)				
		Master <b>BASIC</b> (39.01...)	Master <b>PLUS</b> (39.61...)	Master <b>INPUT</b> (39.71...)	Master <b>OUTPUT</b> (39.51...)	Master <b>TIMER</b> (39.91...)
6 V AC/DC	34.51.7.005.xx10	93.60.7.024	93.66.7.024	93.67.7.024	93.65.7.024	—
12 V AC/DC	34.51.7.012.xx10	93.60.7.024	93.66.7.024	93.67.7.024	93.65.7.024	93.69.0.024
24 V AC/DC	34.51.7.024.xx10	93.60.7.024	93.66.7.024	93.67.7.024	93.65.7.024	93.69.0.024
60 V AC/DC	34.51.7.060.xx10	—	93.66.7.060	—	—	—
(110...125)V AC/DC*	34.51.7.060.xx10	—	93.66.3.125	—	—	—
(220...240)V AC*	34.51.7.060.xx10	—	93.66.3.230	—	—	—
(110...125)V AC/DC	34.51.7.060.xx10	93.60.0.125	93.66.0.125	93.67.0.125	93.65.0.125	—
(24...240)V AC/DC	34.51.7.024.xx10	—	93.66.0.240	—	—	—
(220...240)V AC	34.51.7.060.xx10	93.60.8.230	93.66.8.230	93.67.8.230	93.65.8.230	—
(110...125)V DC	34.51.7.060.xx10	—	93.66.7.125	—	—	—
220 V DC	34.51.7.060.xx10	—	93.66.7.220	—	—	—

\* Leakage current suppression

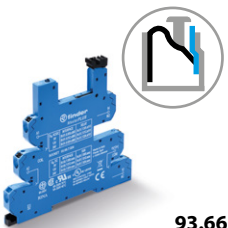

93.66



93.67

**Solid State Relay - SSR**

Supply voltage	Relay type	Socket type (reference with the 39 Series)				
		Master <b>BASIC</b> (39.00...)	Master <b>PLUS</b> (39.60...)	Master <b>INPUT</b> (39.70...)	Master <b>OUTPUT</b> (39.50...)	Master <b>TIMER</b> (39.90...)
12 V AC/DC	34.81.7.012.xxxx	—	—	—	—	93.69.0.024
24 V AC/DC	34.81.7.024.xxxx	—	93.66.0.024	93.67.0.024	—	93.69.0.024
(110...125)V AC/DC*	34.81.7.060.xxxx	—	93.66.3.125	—	—	—
(220...240)V AC*	34.81.7.060.xxxx	—	93.66.3.230	—	—	—
(110...125)V AC/DC	34.81.7.060.xxxx	93.60.0.125	93.66.0.125	93.67.0.125	93.65.0.125	—
(24...240)V AC/DC	34.81.7.024.xxxx	—	93.66.0.240	—	—	—
(220...240)V AC	34.81.7.060.xxxx	93.60.8.230	93.66.8.230	93.67.8.230	93.65.8.230	—
6 V DC	34.81.7.005.xxxx	93.60.7.024	93.66.7.024	93.67.7.024	93.65.7.024	—
12 V DC	34.81.7.012.xxxx	93.60.7.024	93.66.7.024	93.67.7.024	93.65.7.024	—
24 V DC	34.81.7.024.xxxx	93.60.7.024	93.66.7.024	93.67.7.024	93.65.7.024	—
60 V DC	34.81.7.060.xxxx	—	93.66.7.060	—	—	—
(110...125)V DC	34.81.7.060.xxxx	—	93.66.7.125	—	—	—
220 V DC	34.81.7.060.xxxx	—	93.66.7.220	—	—	—

\* Leakage current suppression

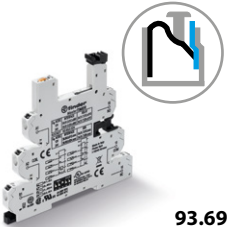

93.69

Approvals  
(according to type):



**Accessories**

16-way jumper link	093.16 (blue), 093.16.0 (black), 093.16.1 (red)
Dual-purpose plastic separator	093.60
Terminal doubler	093.62
Sheet of marker tags	060.48 and 093.48

**Technical data**

Rated values	6 A - 250 V
Dielectric strength	6 kV (1.2/50 μs) between coil and contacts
Protection category	IP 20
Ambient temperature	°C -40...+70
Wire strip length	mm 8
Max wire size	Solid wire and stranded wire
	mm <sup>2</sup> 1 x (0.5...2.5)
	AWG 1 x (21...14)

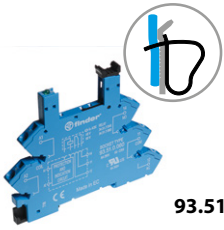

93.51

**Screw less terminal socket 35 mm rail mounting (EN 60715)****Common features**

- Space saving 6.2 mm wide
- Connections for 20-way jumper link
- Integral coil indication and protection circuit
- Secure retention and easy ejection by plastic clip

For technical data and supply versions, refer to the **38 Series** – “Relay interface module”Approvals  
(according to type):

RINA cRU<sup>®</sup> US  
 Certain relay/socket combinations

**Electromechanical Relay - EMR and Solid State Relay - SSR**

Supply voltage	Relay type (reference with the 38 Series)		Socket type
	Electromechanical relay - EMR (38.61...)	Solid State Relay - SSR (38.81...)	
12 V AC/DC	34.51.7.012.xx10	—	93.51.0.024
24 V AC/DC	34.51.7.024.xx10	—	93.51.0.024
(110...125)V AC/DC	34.51.7.060.xx10	34.81.7.060.xxxx	93.51.0.125
(220...240)V AC/DC	34.51.7.060.xx10	34.81.7.060.xxxx	93.51.0.240
(110...125)V AC/DC*	34.51.7.060.xx10	34.81.7.060.xxxx	93.51.3.125
(220...240)V AC*	34.51.7.060.xx10	34.81.7.060.xxxx	93.51.3.240
(220...240)V AC	34.51.7.060.xx10	34.81.7.060.xxxx	93.51.8.240
12 V DC	34.51.7.012.xx10	34.81.7.012.xxxx	93.51.7.024
24 V DC	34.51.7.024.xx10	34.81.7.024.xxxx	93.51.7.024
60 V DC	34.51.7.060.xx10	34.81.7.060.xxxx	93.51.7.060

\* Leakage current suppression

**Accessories**

20-way jumper link	093.20
Plastic separator	093.01
Sheet of marker tags	093.48

**Technical data**

Rated values	6 A - 250 V
Dielectric strength	6 kV (1.2/50 μs) between coil and contacts
Protection category	IP 20
Ambient temperature ( $U_N \leq 60 \text{ V} / > 60 \text{ V}$ )	°C -40...+70 / -40...+55
Wire strip length	mm 10
Max wire size	Solid wire and stranded wire
	mm <sup>2</sup> 1 x 2.5 / 2 x 1.5
	AWG 1 x 14 / 2 x 16





93.11

Approvals  
(according to type):



<b>PCB socket with retaining and release clip</b>	<b>93.11 (blue)</b>
For relay type	34.51, 34.81
<b>Technical data</b>	
Rated values	6 A - 250 V
Dielectric strength	≥ 6 kV (1.2/50 μs) between coil and contacts
Protection category	IP 20
Ambient temperature	°C -40...+70

**Retaining and release clip use:**

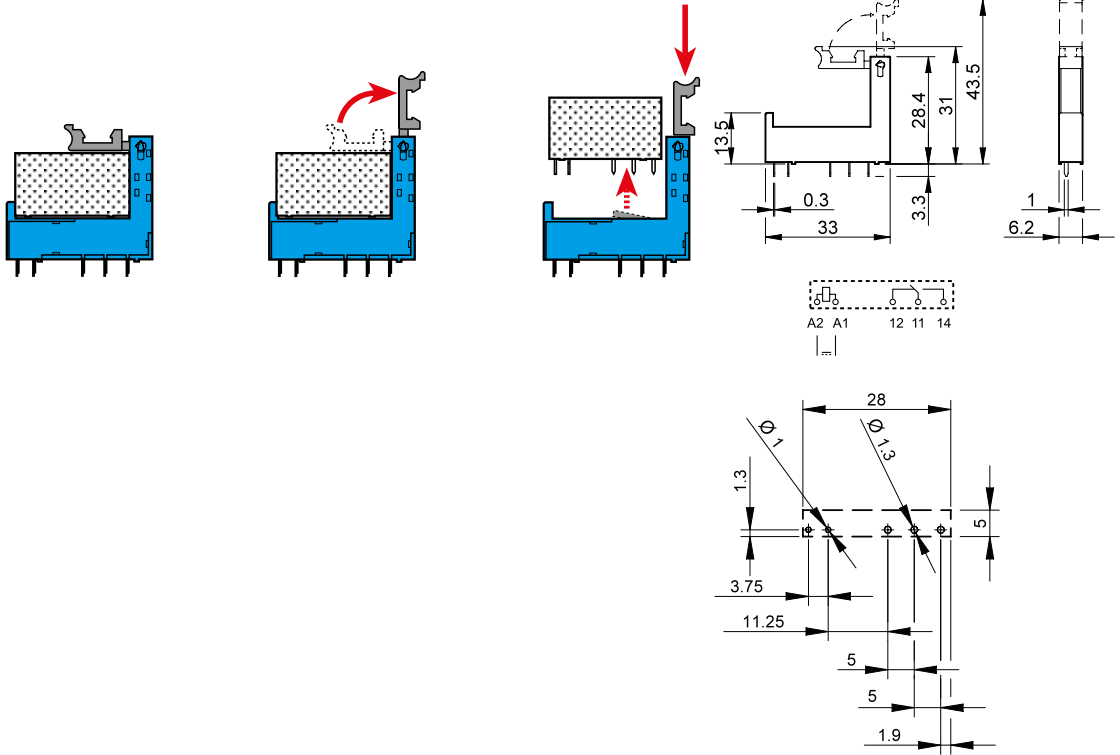



# Miniature PCB relays 10 A



Burners, boilers and furnaces



Jacuzzis and hot tubs



Washing machines



Hi-Fi systems



Refrigerators



Automation for blinds, grilles and shutters

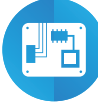

Electronic circuit boards



Electronic kits

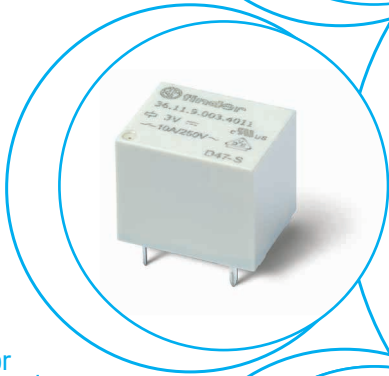



**Printed circuit mount 10 A relay**

- New smaller size
- 1 Pole changeover contacts
- Miniature - "Sugar cube" package
- DC coil - 360 mW
- Wash tight: RT III
- Cadmium Free contact material
- RoHS conform

**36.11-4011**



- 1 CO (SPDT), 10 A
- Sugar cube size
- PCB mount

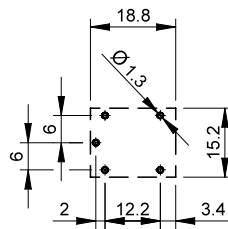
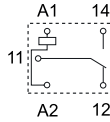

Copper side view

For outline drawing see page 5

**Contact specification**

Contact configuration		1 CO (SPDT)
Rated current/Maximum peak current	A	10/15 (NO) - 5/10 (NC)
Rated voltage/ Maximum switching voltage	V AC	250/277
Rated load AC1	VA	2500 (NO) - 1250 (NC)
Rated load AC15 (230 V AC)	VA	500 (NO)
Single phase motor rating (230 V AC)	kW	0.37 (NO)
Breaking capacity DC1: 28 V	A	10 (NO)
Minimum switching load	mW (V/mA)	500 (5/100)
Standard contact material		AgSnO <sub>2</sub>

**Coil specification**

Nominal voltage (U <sub>N</sub> )	V AC (50/60 Hz)	—
	V DC	3 - 5 - 6 - 9 - 12 - 18 - 24 - 48
Rated power AC/DC	VA (50 Hz)/W	—/0.36
Operating range	AC	—
	DC	(0.75...1.3)U <sub>N</sub>
Holding voltage	AC/DC	—/0.5 U <sub>N</sub>
Must drop-out voltage	AC/DC	—/0.1 U <sub>N</sub>

**Technical data**

Mechanical life AC/DC	cycles	—/10 · 10 <sup>6</sup>
Electrical life at rated load AC1	cycles	50 · 10 <sup>3</sup>
Operate/release time	ms	10/5
Insulation between coil and contacts (1.2/50 μs)	kV	4
Dielectric strength between open contacts	V AC	750
Ambient temperature range	°C	-40...+85
Environmental protection		RT III

**Approvals** (according to type)



## Ordering information

Example: 36 series miniature PCB relay, 1 CO (SPDT) - 10 A contacts, 12 V DC coil.

A

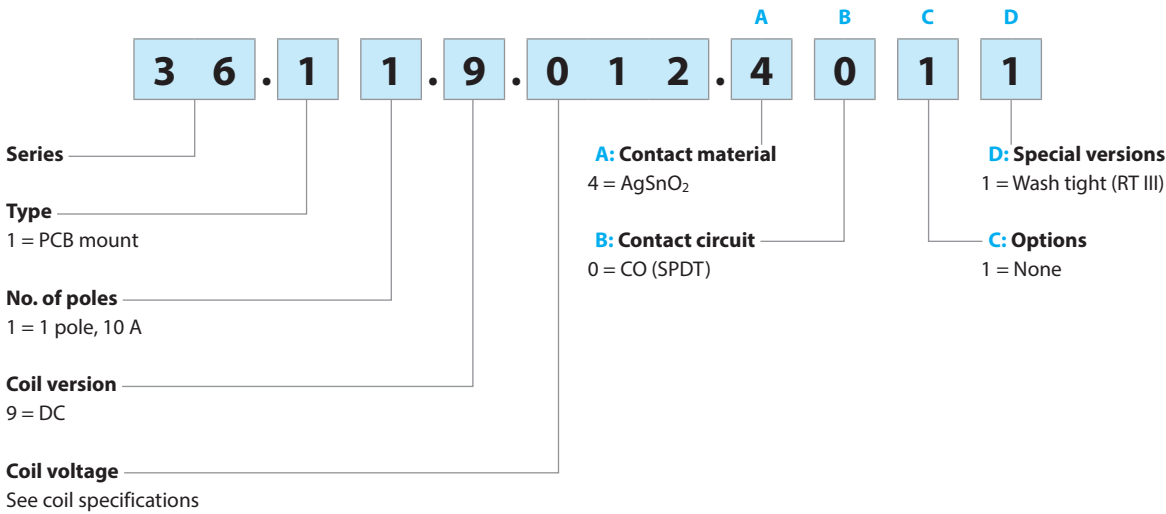

**Selecting features and options: only combinations in the same row are possible.**

Preferred selections for best availability are shown in **bold**.

Type	Coil version	A	B	C	D
36.11	DC	<b>4</b>	<b>0</b>	<b>1</b>	<b>1</b>

## Technical data

### Insulation according to EN 61810-1

Nominal voltage of supply system	V AC	230/400
Rated insulation voltage	V AC	250
Pollution degree		2

### Insulation between coil and contact set

Type of insulation		Basic
Overvoltage category		II
Rated impulse voltage	kV (1.2/50 μs)	4
Dielectric strength	V AC	2500

### Insulation between open contacts

Type of disconnection		Micro-disconnection
Dielectric strength	V AC/kV (1.2/50 μs)	750/1.5

### Other data

Shock resistance	g	10
Bounce time: NO/NC	ms	1/6
Vibration resistance (5...55 Hz): NO/NC	g	14/8
Power lost to the environment	without contact current	W 0.4
	with rated current	W 1.4
Recommended distance between relays mounted on PCB	mm	≥ 5

A

## Contact specification

F 36 - Electrical life (AC) v contact current

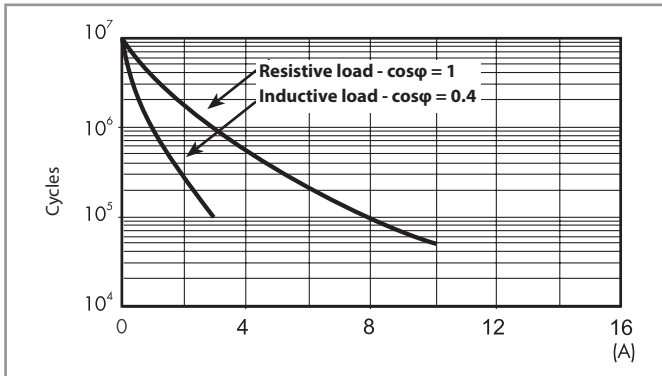

## Coil specifications

DC coil data

Nominal voltage $U_N$ V	Coil code	Operating range		Resistance R $\Omega$	Rated coil consumption I at $U_N$ mA
		$U_{min}$ V	$U_{max}$ V		
3	9.003	2.2	3.9	25	120
5	9.005	3.7	6.5	70	72
6	9.006	4.5	7.8	100	60
9	9.009	6.7	11.7	225	40
12	9.012	9	15.6	400	30
18	9.018	13.5	23.4	900	20
24	9.024	18	31.2	1600	15
48	9.048	36	62.4	6400	7.5

R 36 - DC coil operating range v ambient temperature

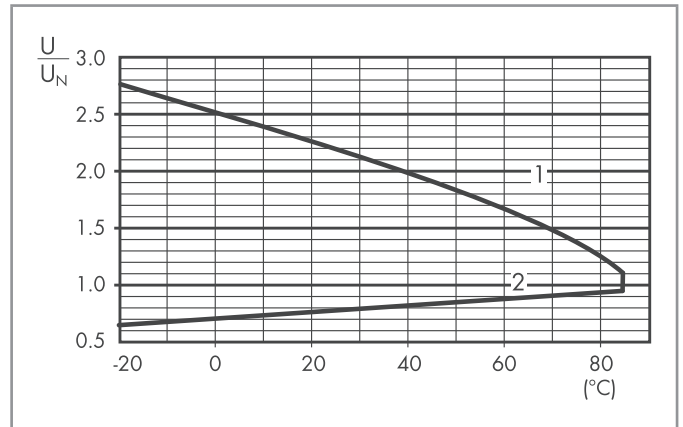

- 1 - Max. permitted coil voltage.
- 2 - Min. pick-up voltage with coil at ambient temperature.

## Outline drawing

Type 36.11-4011

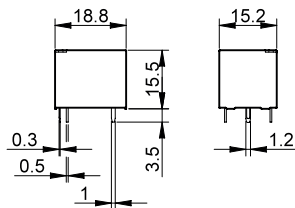





# Miniature PCB Relays

## 8 - 10 - 12 - 16 A



Medical and dentistry



Control panels



Panels for electrical distribution



Toys



Automation for blinds, grilles and shutters



Door and gate openers

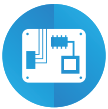

Electronic circuit boards



Vending machines

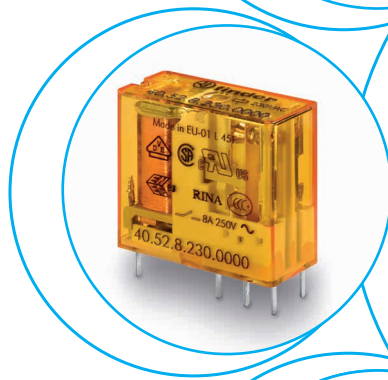



**Power relays 1 and 2 pole for direct PCB or socket mount**

**Type 40.31/51**

- 1 CO 12 A (3.5 mm pin pitch)
- 1 CO 12 A (5.0 mm pin pitch)

**Type 40.52**

- 2 CO 8 A (5.0 mm pin pitch)

**Type 40.61**

- 1 CO 16 A (5.0 mm pin pitch)

- Pin length 3.5 mm for PCB mount
- Pin length 5.3 mm for Plug-in mount
- DC coils (650 mW or 500 mW) and AC coils
- 8 mm Creepage and Clearance, 6 kV (1.2/50µs) between coil and contact
- Meets EN 60335-1 glow wire requirements
- 95 series sockets for PCB or 35 mm rail mounting (EN 60715) with Screw, Screwless or Push-in terminals
- Coil Indication and EMC suppression modules 99 series and Timer module 86.30 options
- Environmental protection:  
RT II - flux proof (Standard)  
RT III - wash tight (Option)

\* Mounted on sockets ≤ 10 A

\*\* With the AgSnO<sub>2</sub> material the maximum peak current on normally open contact, is 120 A - 5 ms (for 40.61) and 60 A - 5 ms (for 40.52)

FOR UL RATINGS SEE:

"General technical information" page V

For outline drawing see page 10

**40.31/51**



- 1 CO 12 A on PCB, 10 A with socket
- 3.5 mm pin pitch (40.31), 5.0 mm pin pitch (40.51)
- PCB or 95 Series socket mount

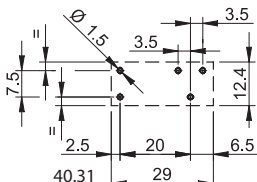
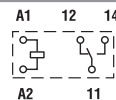

Copper side view

Pin length 3.5 mm for PCB only  
Pin length 5.3 mm for PCB or sockets

See ordering information

**40.52**



- 2 CO 8 A
- 5.0 mm pin pitch
- PCB or 95 Series socket mount

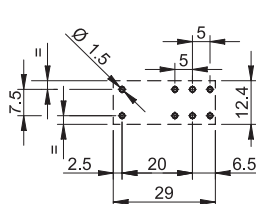
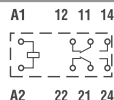

Copper side view

Pin length 5.3 mm for PCB or sockets

See ordering information

**40.61**



- 1 CO 16 A
- 5.0 mm pin pitch
- PCB or 95 Series socket mount

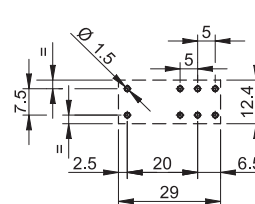
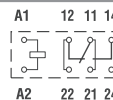

Copper side view

Pin length 3.5 mm for PCB only  
Pin length 5.3 mm for PCB or sockets

See ordering information

**Contact specification**

Contact configuration		1 CO (SPDT)	2 CO (DPDT)	1 CO (SPDT)
Rated current/Maximum peak current	A	12*/20	8/15**	16/30**
Rated voltage/Maximum switching voltage	V AC	250/400	250/400	250/400
Rated load AC1	VA	3000	2000	4000
Rated load AC15 (230 V AC)	VA	1000	750	1000
Single phase motor rating (230 V AC)	kW	0.55	0.37	0.55
Breaking capacity DC1: 24/110/220 V	A	12/0.6/0.25	8/0.6/0.25	16/0.6/0.25
Minimum switching load	mW (V/mA)	300 (5/5)	300 (5/5)	500 (10/5)
Standard contact material		AgNi	AgNi	AgNi

**Coil specification**

Nominal voltage (U <sub>N</sub> )	V AC (50/60 Hz)	6 - 12 - 24 - 48 - 60 - 110 - 120 - 230 - 240		
	V DC	5 - 6 - 7 - 9 - 12 - 14 - 18 - 21 - 24 - 28 - 36 - 48 - 60 - 90 - 110 - 125		
Rated power AC/DC/sensitive DC	VA (50 Hz)/W/W	1.2/0.65/0.5	1.2/0.65/0.5	1.2/0.65/0.5
Operating range	AC	(0.8...1.1)U <sub>N</sub>	(0.8...1.1)U <sub>N</sub>	(0.8...1.1)U <sub>N</sub>
	DC/sensitive DC	(0.73...1.5)U <sub>N</sub> /(0.73...1.5)U <sub>N</sub>	(0.73...1.5)U <sub>N</sub> /(0.73...1.5)U <sub>N</sub>	(0.73...1.5)U <sub>N</sub> /(0.8...1.5)U <sub>N</sub>
Holding voltage	AC/DC	0.8 U <sub>N</sub> /0.4 U <sub>N</sub>	0.8 U <sub>N</sub> /0.4 U <sub>N</sub>	0.8 U <sub>N</sub> /0.4 U <sub>N</sub>
Must drop-out voltage	AC/DC	0.2 U <sub>N</sub> /0.1 U <sub>N</sub>	0.2 U <sub>N</sub> /0.1 U <sub>N</sub>	0.2 U <sub>N</sub> /0.1 U <sub>N</sub>

**Technical data**

Mechanical life	cycles	10 · 10 <sup>6</sup>	10 · 10 <sup>6</sup>	10 · 10 <sup>6</sup>
Electrical life at rated load AC1	cycles	200 · 10 <sup>3</sup>	100 · 10 <sup>3</sup>	100 · 10 <sup>3</sup>
Operate/release time	ms	7/3 (10/3 sensitive)	7/3 (12/4 sensitive)	7/3 (10/3 sensitive)
Insulation between coil and contacts (1.2/50 µs)	kV	6 (8 mm)	6 (8 mm)	6 (8 mm)
Dielectric strength between open contacts	V AC	1000	1000	1000
Ambient temperature range	°C	-40...+85	-40...+85	-40...+85
Environmental protection		RT II***	RT II***	RT II***

**Approvals** (according to type)



\*\*\* See general technical information "Guidelines for automatic flow solder processes" page II.

**Power relays 1 and 2 pole for direct PCB or socket mount**

**Type 40.62**

- 2 CO 10A (5.0 mm pin pitch)
- DC coils (650 mW or 500 mW) and AC coils
- Meets EN 60335-1 glow wire requirements

**Type 40.xx.6**

- Bistable versions of the types 40.31, 40.51, 40.52 and 40.61
- Bistable (single coil)

- Cadmium-free contact material available
- 8 mm Creepage and Clearance, 6 kV (1.2/50µs) between coil and contact
- 95 series sockets for PCB or 35 mm rail mounting (EN 60715) with Screw, Screwless or Push-in terminals
- Environmental protection:  
RT II - flux proof (Standard)  
RT III - wash tight (Option)

\* With the AgSnO<sub>2</sub> material the maximum peak current on normally open contact is 60 A - 5 ms (for 40.62)

FOR UL RATINGS SEE:  
"General technical information" page V

For outline drawing see page 10

**Contact specification**

Contact configuration		2 CO (DPDT)
Rated current/Maximum peak current	A	10/20*
Rated voltage/Maximum switching voltage	V AC	250/400
Rated load AC1	VA	2500
Rated load AC15 (230 V AC)	VA	750
Single phase motor rating (230 V AC)	kW	0.37
Breaking capacity DC1: 24/110/220 V	A	10/0.6/0.25
Minimum switching load	mW (V/mA)	300 (5/5)
Standard contact material		AgNi

**Coil specification**

Nominal voltage (U <sub>N</sub> )	V AC (50/60 Hz)	110 - 120 - 230 - 240	
	V DC	5 - 6 - 7 - 9 - 12 - 14 - 18 - 21 - 24 - 28 - 48 - 60 - 110 - 125	5 - 6 - 12 - 24 - 48 - 110
Rated power AC/DC/sens. DC	VA (50 Hz)/W/W	1.2/0.65/0.5	1.0/1.0/—
Operating range	AC	(0.8...1.1)U <sub>N</sub>	(0.8...1.1)U <sub>N</sub>
	DC/sens. DC	(0.73...1.5)U <sub>N</sub> / (0.73...1.5) U <sub>N</sub>	(0.8...1.1)U <sub>N</sub> / —
Holding voltage	AC/DC	0.8/0.4 U <sub>N</sub>	—
Must drop-out voltage	AC/DC	0.2/0.1 U <sub>N</sub>	—

**Technical data**

Mechanical life	cycles	10 · 10 <sup>6</sup>	See relays
Electrical life at rated load AC1	cycles	100 · 10 <sup>3</sup>	40.31
Operate/release time	ms	7/3 (12/4 sensitive)	40.51
Insulation between coil and contacts (1.2/50 µs)	kV	6 (8 mm)	40.52
Dielectric strength between open contacts	V AC	1000	40.61
Ambient temperature range	°C	-40...+85	Min. impulse duration
Environmental protection		RT II	≥ 20 ms

**Approvals** (according to type)



\*\* See general technical information "Guidelines for automatic flow solder processes" page II.

**NEW 40.62**



- 2 CO 10 A
- 5.0 mm pin pitch
- PCB or 95 Series sockets mount

**40.xx.6**



- Bistable (single coil)
- 3.5 or 5.0 mm pin pitch
- PCB or 95 Series socket mount

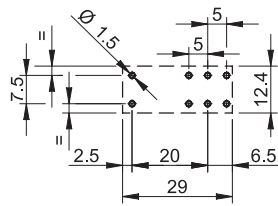
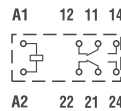

Copper side view

Pin length 5.3 mm for  
PCB or sockets

Bistable version (1 coil) types:

- 40.31.6...
- 40.51.6...
- 40.52.6...
- 40.61.6...

For wiring diagrams see page 10

Pin length 5.3 mm for  
PCB or sockets

## Ordering information

Example: 40 series PCB relay, 2 CO, 230 V AC coil.

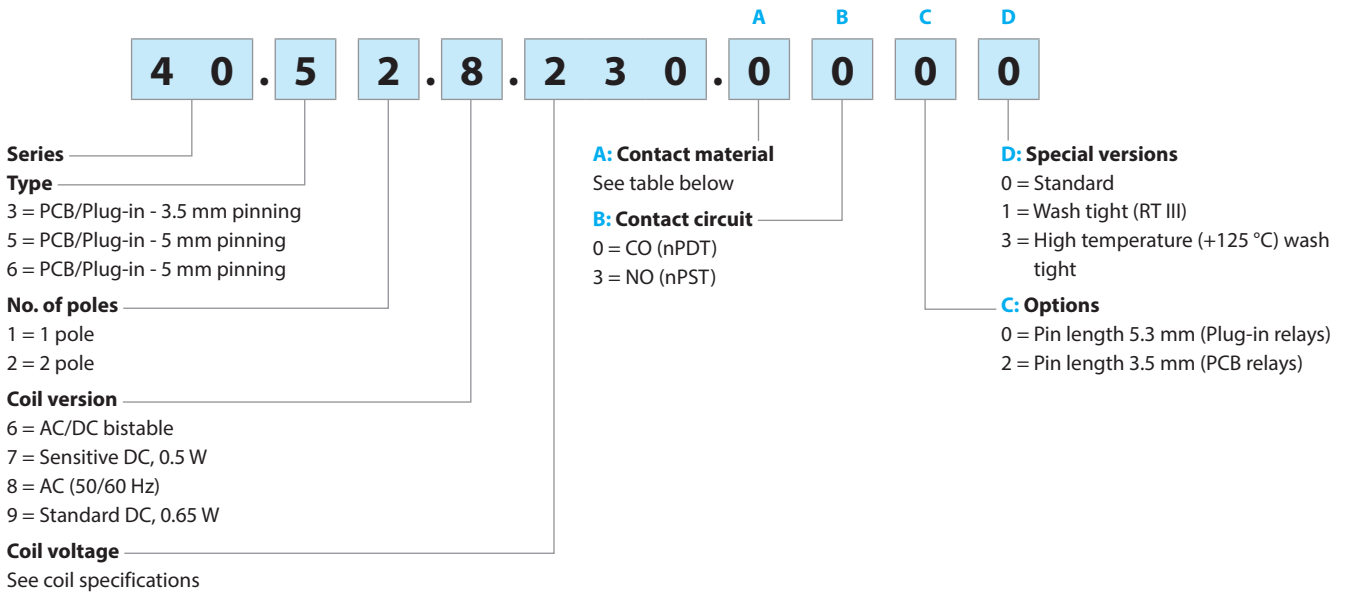

**Selecting features and options: only combinations in the same row are possible.**

Preferred selections for best availability are shown in **bold**.

Terminal pin	Type	Coil version	A	B	C	D
PCB relay, pin length 3.5 mm	40.31/51	Standard DC/sensitive DC	<b>1</b> (AgNi)	<b>0</b> - 3	<b>2</b>	<b>0</b> - 1
	40.61	Standard DC/sensitive DC	1 (AgNi) - <b>4</b> (AgSnO <sub>2</sub> )	<b>0</b> - 3	<b>2</b>	<b>0</b> - 1
PCB/Plug-in relay pin length 5.3 mm	40.31/51	AC/sensitive DC	<b>0</b> (AgNi) - 4 (AgSnO <sub>2</sub> ) - 5 (AgNi+Au)	<b>0</b> - 3	<b>0</b>	<b>0</b> - 1
	40.31/51	Standard DC	<b>0</b> (AgNi) - 4 (AgSnO <sub>2</sub> ) - 5 (AgNi+Au)	<b>0</b> - 3	<b>0</b>	<b>0</b> - 1 - 3
	40.52	AC/sensitive DC	<b>0</b> (AgNi) - 4 (AgSnO <sub>2</sub> ) - 5 (AgNi+Au)	<b>0</b> - 3	<b>0</b>	<b>0</b> - 1
	40.52	Standard DC	<b>0</b> (AgNi) - 4 (AgSnO <sub>2</sub> ) - 5 (AgNi+Au)	<b>0</b> - 3	<b>0</b>	<b>0</b> - 1 - 3
	40.61	AC/sensitive DC	<b>1</b> (AgNi) - 4 (AgSnO <sub>2</sub> )	<b>0</b> - 3	<b>0</b>	<b>0</b> - 1
	40.61	Standard DC	<b>1</b> (AgNi) - 4 (AgSnO <sub>2</sub> )	<b>0</b> - 3	<b>0</b>	<b>0</b> - 1 - 3
	40.62	AC/DC/sensitive DC	<b>0</b> (AgNi) - 4 (AgSnO <sub>2</sub> )	<b>0</b>	<b>0</b>	<b>0</b> - 1
	40.31/51/52	Bistable	<b>0</b> (AgNi)	<b>0</b>	<b>0</b>	<b>0</b>
	40.61	Bistable	<b>1</b> (AgNi)	<b>0</b>	<b>0</b>	<b>0</b>

## Technical data

### Insulation according to EN 61810-1

		1 pole		2 pole	
Nominal voltage of supply system	V AC	230/400		230/400	
Rated insulation voltage	V AC	250	400	250	400
Pollution degree		3	2	3	2
<b>Insulation between coil and contact set</b>					
Type of insulation		Reinforced (8 mm)		Reinforced (8 mm)	
Overvoltage category		III		III	
Rated impulse voltage	kV (1.2/50 μs)	6		6	
Dielectric strength	V AC	4000		4000	
<b>Insulation between adjacent contacts (40.52)</b>					
Type of insulation		—		Basic	
Overvoltage category		—		II	
Rated impulse voltage	kV (1.2/50 μs)	—		2.5	
Dielectric strength	V AC	—		2000	
<b>Insulation between adjacent contacts (40.52 + 40.62)</b>					
Type of insulation		—		Basic	
Overvoltage category		—		III	
Rated impulse voltage	kV (1.2/50 μs)	—		4	
Dielectric strength	V AC	—		2500	
<b>Insulation between open contacts</b>					
Type of disconnection		Micro-disconnection		Micro-disconnection	
Dielectric strength	V AC/kV (1.2/50 μs)	1000/1.5		1000/1.5	
<b>Insulation between coil terminals</b>					
Rated impulse voltage (surge) differential mode (according to EN 61000-4-5)	kV (1.2/50 μs)	2			
<b>Other data</b>					
Bounce time: NO/NC	ms	2/5			
Vibration resistance (10...150)Hz: NO/NC	g	20/5 (1 changeover)		15/4 (2 changeover)	
Shock resistance NO/NC	g	20/13 (1 changeover)		20/12 (2 changeover)	
Power lost to the environment	without contact current	W	0.65		
	with rated current	W	1.2 (40.31/51)		2 (40.61/52/62)
Recommended distance between relays mounted on PCB	mm	≥ 5			

## Contact specification

**F 40.1 - Electrical life (AC) v contact current**  
Types 40.31/51/61

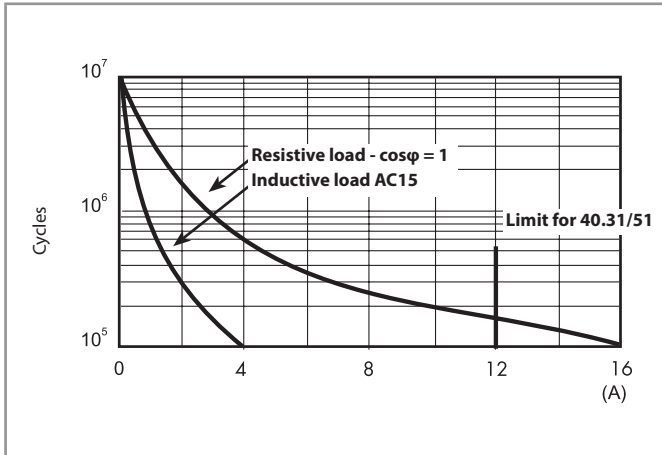

**F 40.2 - Electrical life (AC) v contact current**  
Type 40.52

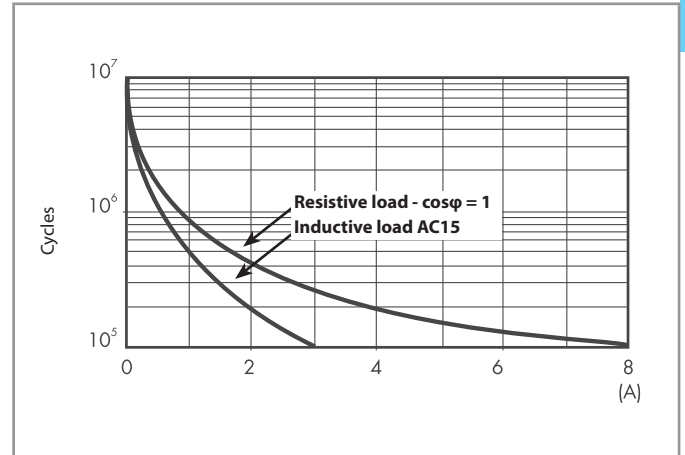

**F 40.6 - Electrical life (AC) v contact current**  
Type 40.62

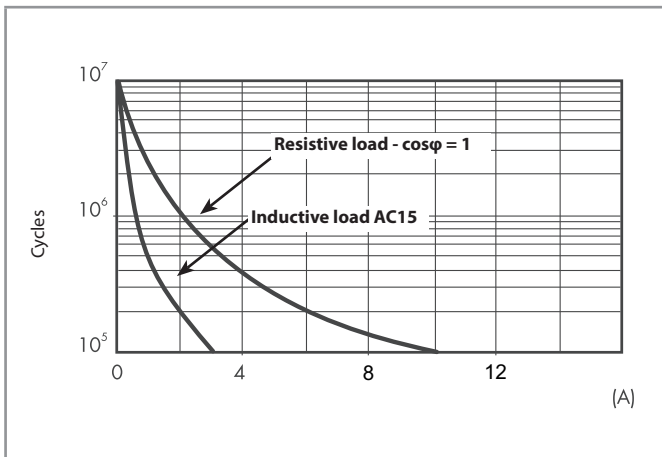

## Contact specification

**H 40.1 - Maximum DC1 breaking capacity**  
Types 40.31/51/52/61

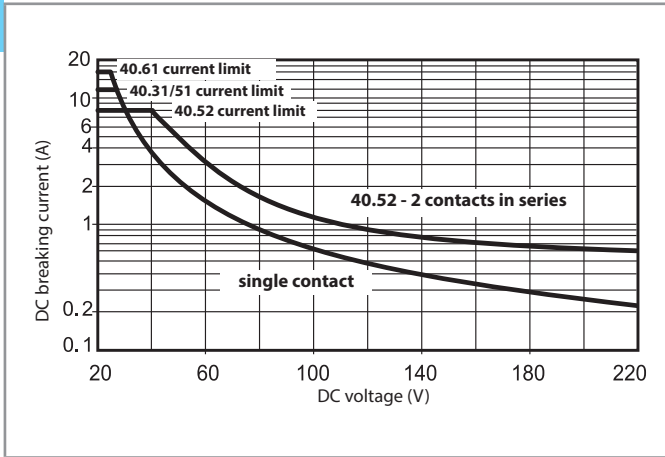

**H 40.6 - Maximum DC1 breaking capacity**  
Type 40.62

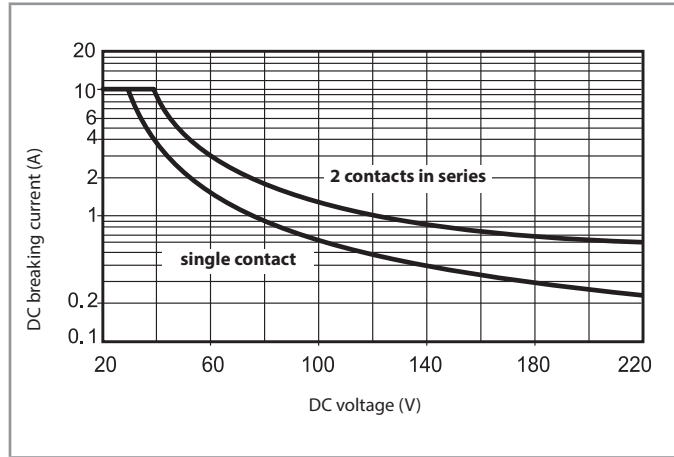

- When switching a resistive load (DC1) having voltage and current values under the curve, an electrical life of  $\geq 100 \cdot 10^3$  can be expected.
  - In the case of DC13 loads, the connection of a diode in parallel with the load will permit a similar electrical life as for a DC1 load.
- Note: the release time for the load will be increased.



## Coil specifications

**DC coil data - 0.65 W standard** (types 40.31/51/52/61/62)

Nominal voltage $U_N$ V	Coil code	Operating range		Resistance R $\Omega$	Rated coil consumption I at $U_N$ mA
		$U_{min}$ V	$U_{max}$ V		
5	9.005	3.65	7.5	38	130
6	9.006	4.4	9	55	109
7	9.007	5.1	10.5	75	94
9	9.009	6.6	13.5	125	72
12	9.012	8.8	18	220	55
14	9.014	10.2	21	300	47
18	9.018	13.1	27	500	36
21	9.021	15.3	31.5	700	30
24	9.024	17.5	36	900	27
28	9.028	20.5	42	1200	23
36	9.036	26.3	54	2000	18
48	9.048	35	72	3500	14
60	9.060	43.8	90	5500	11
90	9.090	65.7	135	12500	7.2
110	9.110	80.3	165	18000	6.2
125	9.125	91.2	188	23500	5.3

**DC coil data - 0.5 W sensitive** (types 40.31/51/52/61/62)

Nominal voltage $U_N$ V	Coil code	Operating range		Resistance R $\Omega$	Rated coil consumption I at $U_N$ mA
		$U_{min}^*$ V	$U_{max}$ V		
5	7.005	3.7	7.5	50	100
6	7.006	4.4	9	75	80
7	7.007	5.1	10.5	100	70
9	7.009	6.6	13.5	160	56
12	7.012	8.8	18	288	42
14	7.014	10.2	21	400	35
18	7.018	13.2	27	650	27.7
21	7.021	15.4	31.5	900	23.4
24	7.024	17.5	36	1150	21
28	7.028	20.5	42	1600	17.5
36	7.036	26.3	54	2600	13.8
48	7.048	35	72	4800	10
60	7.060	43.8	90	7200	8.4
90	7.090	65.7	135	16200	5.6
110	7.110	80.3	165	23500	4.7
125	7.125	91.2	188	32000	3.9

\*  $U_{min} = 0.8 U_N$  for 40.61

**AC coil data** (types 40.31/51/52/61/62)

Nominal voltage $U_N$ V	Coil code	Operating range		Resistance R $\Omega$	Rated coil consumption I at $U_N$ (50 Hz) mA
		$U_{min}$ V	$U_{max}$ V		
6	8.006	4.8	6.6	21	168
12	8.012	9.6	13.2	80	90
24	8.024	19.2	26.4	320	45
48	8.048	38.4	52.8	1350	21
60	8.060	48	66	2100	16.8
110	8.110	88	121	6900	9.4
120	8.120	96	132	9000	8.4
230	8.230	184	253	28000	5
240	8.240	192	264	31500	4.1

**AC/DC coil data - bistable** (types 40.31/51/52/61)

Nominal voltage $U_N$ V	Coil code	Operating range		Resistance R $\Omega$	Rated coil consumption I at $U_N$ mA	DC: Release resistance** $R_{DC}$ $\Omega$
		$U_{min}$ V	$U_{max}$ V			
5	6.005	4	5.5	23	215	37
6	6.006	4.8	6.6	33	165	62
12	6.012	9.6	13.2	130	83	220
24	6.024	19.2	26.4	520	40	910
48	6.048	38.4	52.8	2100	21	3600
110	6.110	88	121	11000	10	16500

\*\*  $R_{DC}$  = Resistance in DC,  $R_{AC} = 1.3 \times R_{DC}$  1 W

## Coil specifications

**R 40 - DC coil operating range v ambient temperature**  
Standard coil

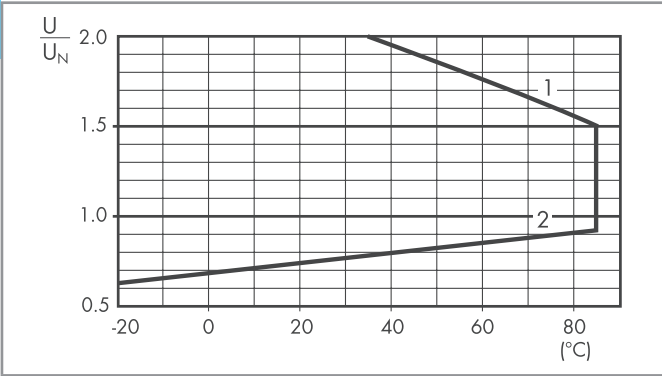

**R 40 - DC coil operating range v ambient temperature**  
Sensitive coil, types 40.31/51/52/61/62

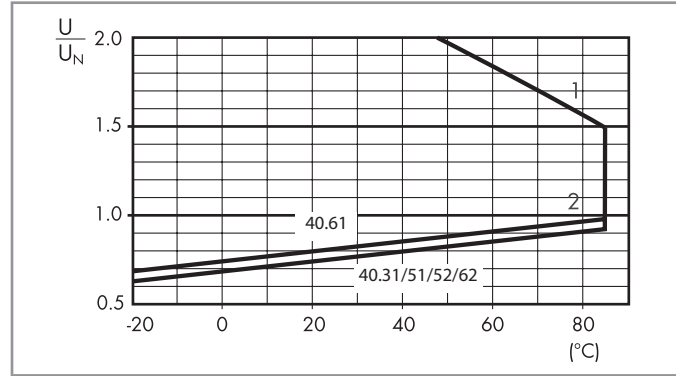

**R 40 - AC coil operating range v ambient temperature**

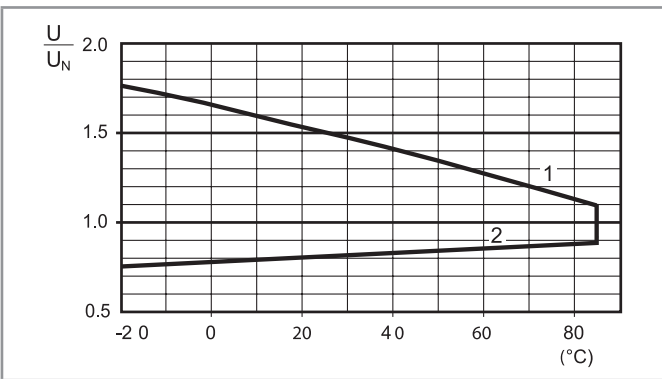

- 1 - Max. permitted coil voltage.
- 2 - Min. pick-up voltage with coil at ambient temperature.

### Wiring diagram for 40 series bistable coil version

#### AC Operation

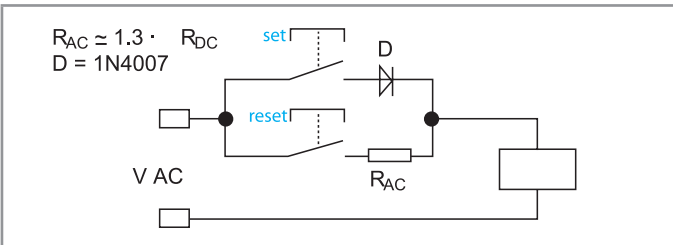

#### DC Operation

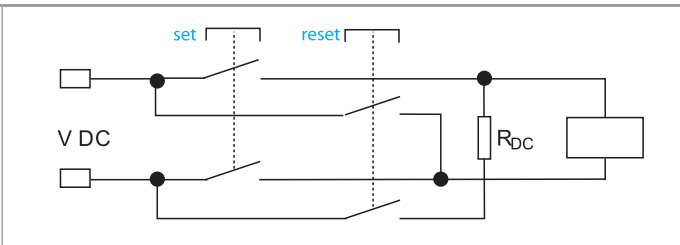

On momentary closure of the SET switch the relay is magnetised through the diode and the relay contacts transfer to the set position and remain in this position.  
On momentary closure of the RESET switch the relay is demagnetised through limiting resistor ( $R_{AC}$ ) and the contacts return to the reset position.

On momentary closure of the SET switch the relay is magnetised and the relay contacts transfer to the set position and remain in this position.  
On momentary closure of the RESET switch the relay is demagnetised through limiting resistor ( $R_{DC}$ ) and the contacts return to the reset position.

**Notes:** The minimum SET or RESET impulse time is 20 ms. The maximum time can be continuous. In practice, always ensure that the SET and RESET contacts cannot be operated simultaneously.

## Outline drawings

Types 40.31/51/52/61/62

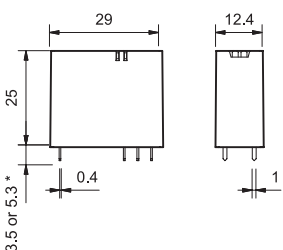

\* (3.5 or 5.3 mm) see ordering code



Module	Socket	Relay	Description	Mounting	Accessories
99.02	95.P3	40.31	<b>Push-in terminal sockets</b> - For fast cable connection - Top terminals - Contacts - Bottom terminals - Coil	Panel or 35 mm rail (EN 60715) mount	- Coil indication and EMC suppression modules - Jumper link - Timer modules - Plastic retaining and release clip
	95.P5	40.51			
	40.52				
	40.61				
	40.62				



Module	Socket	Relay	Description	Mounting	Accessories
99.02	95.03	40.31	<b>Screw terminal (Box clamp) socket</b> - Top terminals - Contacts - Bottom terminals - Coil	Panel or 35 mm rail (EN 60715) mount	- Coil indication and EMC suppression modules - Jumper link - Timer modules - Plastic retaining and release clip
	95.05	40.51			
	40.52				
	40.61				
	40.62				

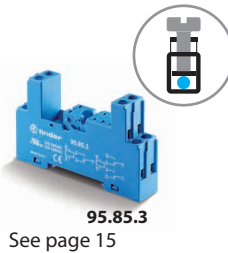

Module	Socket	Relay	Description	Mounting	Accessories
99.80	95.83.3	40.31	<b>Screw terminal (Box clamp) socket</b> - Top terminals - NO and COM Contacts - Bottom terminals - Coil and NC Contacts	Panel or 35 mm rail (EN 60715) mount	- Coil indication and EMC suppression modules - Jumper link - Plastic retaining and release clip
	95.85.3	40.51			
	40.52				
	40.61				
	40.62				



Module	Socket	Relay	Description	Mounting	Accessories
99.80	95.93.3	40.31	<b>Screw terminal (Box clamp) socket</b> - Top terminals - Contacts - Bottom terminals - Coil	Panel or 35 mm rail (EN 60715) mount	- Coil indication and EMC suppression modules - Jumper link - Plastic retaining and release clip
	95.95.3	40.51			
	40.52				
	40.61				
	40.62				

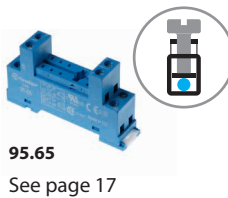

Module	Socket	Relay	Description	Mounting	Accessories
99.01	95.63	40.31	<b>Screw terminal (Box clamp) socket</b> - Top terminals - Contacts - Bottom terminals - Coil	Panel or 35 mm rail (EN 60715) mount	- Metal retaining clip
	95.65	40.51			
	40.52				
	40.61				
	40.62				



Module	Socket	Relay	Description	Mounting	Accessories
—	95.13.2	40.31	<b>PCB socket</b>	PCB mounting	- Metal retaining clip - Plastic retaining clip
—	95.15.2	40.51			
		40.52			
		40.61			
	40.62				

A

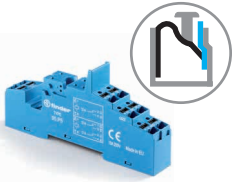

**95.P5**  
Approvals  
(according to type):



**095.91.3**

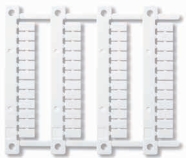

**060.48**

Push-in terminals socket panel or 35 mm rail mount	95.P3	95.P5
For relay type	40.31	40.51, 40.52, 40.61, 40.62
<b>Accessories</b>		
Metal retaining clip		095.71
Plastic retaining and release clip (supplied with socket - packaging code SPA)		095.91.3
8-way jumper link		097.58
2-way jumper link (12.5 mm pitch)		097.52
2-way jumper link (4.6 mm pitch)		097.42
Marker tag holder (for tags 060.48 type)		097.00
Identification tag		095.00.4
Modules (see table below)		99.02
Timer modules (see table below)		86.30
Sheet of marker tags for plastic retaining and release clip 095.91.3 and for marker tag holder 097.00, 48 tags, 6 x 12 mm, for CEMBRE thermal transfert printer		060.48
<b>Technical data</b>		
Rated values	10 A - 250 V*	
Dielectric strength between coil and contacts (1.2/50 μs)	6 kV	
Protection category	IP 20	
Ambient temperature	°C -40...+70 (see diagram L95)	
Wire strip length	mm 10	
Min. wire size for 95.P3 and 95.P5 sockets	solid wire	stranded wire
	mm <sup>2</sup> 0.5	0.5
	AWG 21	21
Max. wire size for 95.P3 and 95.P5 sockets	solid wire	stranded wire
	mm <sup>2</sup> 2 x 1.5 / 1 x 2.5	2 x 1.5 / 1 x 2.5
	AWG 2 x 16 / 1 x 14	2 x 16 / 1 x 14

\* For currents > 10 A, contact terminals must be connected in parallel (21 with 11, 24 with 14, 22 with 12).  
With the relay 40.51 the change-over contact will be 21-12-14.

**L 95 - Total socket current v ambient temperature**

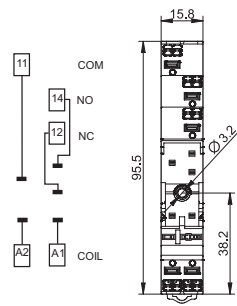
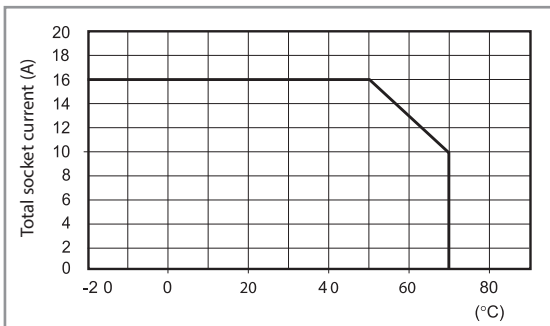

95.P3

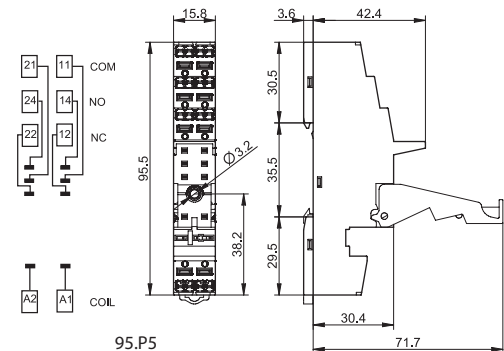

95.P5



**097.58**

<b>8-way jumper link for 95.P3 and 95.P5 sockets</b>	097.58
Rated values	10 A - 250 V

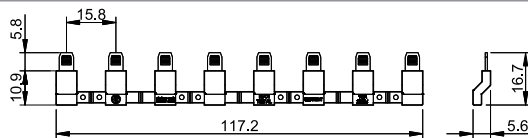

**097.52**

<b>2-way jumper link for 95.P3 and 95.P5 sockets</b>	097.52
Rated values	10 A - 250 V

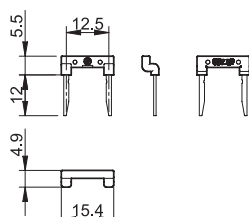



097.42

<b>2-way jumper link</b> for 95.P3 and 95.P5 sockets	097.42
Rated values	10 A - 250 V

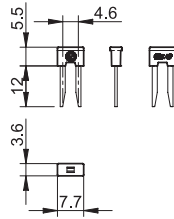

097.00

<b>Marker tag holder</b> for 95.P3 and 95.P5 sockets	097.00
--	--------

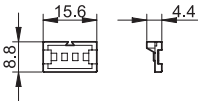

86.30

<b>86 series timer modules</b>	
(12...24)V AC/DC; Bi-function: AI, DI; (0.05 s...100 h)	86.30.0.024.0000
(110...125)V AC; Bi-function: AI, DI; (0.05 s...100 h)	86.30.8.120.0000
(230...240)V AC; Bi-function: AI, DI; (0.05 s...100 h)	86.30.8.240.0000

Approvals (according to type):



99.02

Approvals  
(according to type):



DC Modules with  
non-standard polarity  
(+A2) on request.

<b>99.02 coil indication and EMC suppression modules</b> for 95.P3 and 95.P5 sockets		
Diode (+A1, standard polarity)	(6...220)V DC	99.02.3.000.00
LED	(6...24)V DC/AC	99.02.0.024.59
LED	(28...60)V DC/AC	99.02.0.060.59
LED	(110...240)V DC/AC	99.02.0.230.59
LED + Diode (+A1, standard polarity)	(6...24)V DC	99.02.9.024.99
LED + Diode (+A1, standard polarity)	(28...60)V DC	99.02.9.060.99
LED + Diode (+A1, standard polarity)	(110...220)V DC	99.02.9.220.99
LED + Varistor	(6...24)V DC/AC	99.02.0.024.98
LED + Varistor	(28...60)V DC/AC	99.02.0.060.98
LED + Varistor	(110...240)V DC/AC	99.02.0.230.98
RC circuit	(6...24)V DC/AC	99.02.0.024.09
RC circuit	(28...60)V DC/AC	99.02.0.060.09
RC circuit	(110...240)V DC/AC	99.02.0.230.09
Residual current by-pass*	(110...240)V AC	99.02.8.230.07

\* Additional 0.9 W power dissipation

A



95.05  
Approvals  
(according to type):



095.01

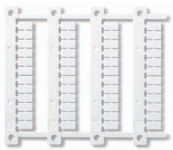

060.48

<b>Screw terminal (Box clamp) socket</b> panel or 35 mm rail mount	<b>95.03 (blue)</b>	<b>95.03.0 (black)</b>	<b>95.05 (blue)</b>	<b>95.05.0 (black)</b>
For relay type	40.31		40.51, 40.52, 40.61, 40.62	
<b>Accessories</b>				
Metal retaining clip	095.71			
Plastic retaining and release clip (supplied with socket - packaging code SPA)	095.01	095.01.0	095.01	095.01.0
8-way jumper link	095.18	095.18.0	095.18	095.18.0
Marker tag holder (for tags 060.48 type)	097.00			
Identification tag	095.00.4			
Modules (see table below)	99.02			
Timer modules (see table below)	86.30			
Sheet of marker tags for plastic retaining and release clip 095.01 and for marker tag holder 097.00, 48 tags, 6 x 12 mm, for CEMBRE thermal transfer printers	060.48			
<b>Technical data</b>				
Rated values	10 A - 250 V*			
Dielectric strength between coil and contacts (1.2/50 μs)	6 kV			
Protection category	IP 20			
Ambient temperature	°C -40...+70 (see diagram L95)			
⊕ Screw torque	Nm 0.5			
Wire strip length	mm 8			
Max. wire size for 95.03 and 95.05 sockets	solid wire		stranded wire	
	mm <sup>2</sup> 1 x 6 / 2 x 2.5		1 x 4 / 2 x 2.5	
	AWG 1 x 10 / 2 x 14		1 x 12 / 2 x 14	

\* For currents > 10 A, contact terminals must be connected in parallel (21 with 11, 24 with 14, 22 with 12).  
With the relay 40.51 the change-over contact will be 21-12-14.

**L 95 - Total socket current v ambient temperature**

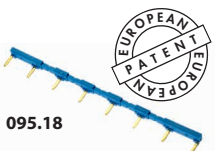
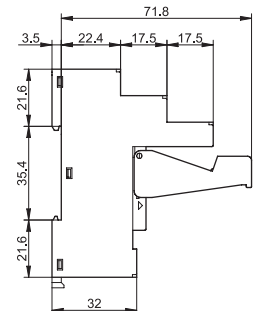
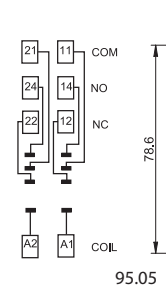
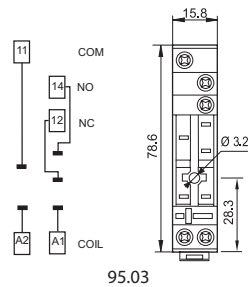
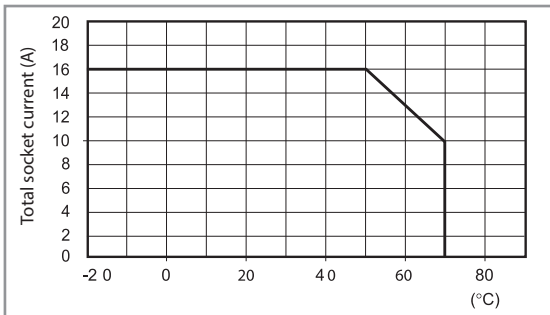

095.18

<b>8-way jumper link for 95.03 and 95.05 sockets</b>	<b>095.18 (blue)</b>	<b>095.18.0 (black)</b>
Rated values	10 A - 250 V	

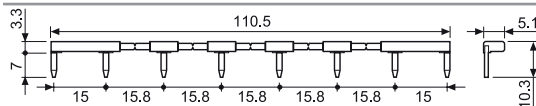

86.30

<b>86 series timer modules</b>		
(12...24)V AC/DC; Bi-function: AI, DI; (0.05 s...100 h)	86.30.0.024.0000	
(110...125)V AC; Bi-function: AI, DI; (0.05 s...100 h)	86.30.8.120.0000	
(230...240)V AC; Bi-function: AI, DI; (0.05 s...100 h)	86.30.8.240.0000	

Approvals (according to type):



99.02

Approvals  
(according to type):



DC Modules with non-standard polarity (+A2) on request.

<b>99.02 coil indication and EMC suppression modules for 95.03 and 95.05 sockets</b>		
Diode (+A1, standard polarity)	(6...220)V DC	99.02.3.000.00
LED	(6...24)V DC/AC	99.02.0.024.59
LED	(28...60)V DC/AC	99.02.0.060.59
LED	(110...240)V DC/AC	99.02.0.230.59
LED + Diode (+A1, standard polarity)	(6...24)V DC	99.02.9.024.99
LED + Diode (+A1, standard polarity)	(28...60)V DC	99.02.9.060.99
LED + Diode (+A1, standard polarity)	(110...220)V DC	99.02.9.220.99
LED + Varistor	(6...24)V DC/AC	99.02.0.024.98
LED + Varistor	(28...60)V DC/AC	99.02.0.060.98
LED + Varistor	(110...240)V DC/AC	99.02.0.230.98
RC circuit	(6...24)V DC/AC	99.02.0.024.09
RC circuit	(28...60)V DC/AC	99.02.0.060.09
RC circuit	(110...240)V DC/AC	99.02.0.230.09
Residual current by-pass*	(110...240)V AC	99.02.8.230.07

\* Additional 0.9 W power dissipation

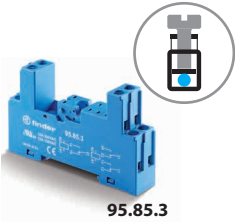

95.83.3

Approvals  
(according to type):



095.91.3

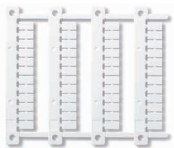

060.48

Screw terminal (Box clamp) socket panel or 35 mm rail mount	95.83.3 (blue)	95.83.30 (black)	95.85.3 (blue)	95.85.30 (black)
For relay type	40.31		40.51, 40.52, 40.61, 40.62	
<b>Accessories</b>				
Metal retaining clip	095.71			
Plastic retaining and release clip (supplied with socket - packaging code SPA)	095.91.3	095.91.30	095.91.3	095.91.30
8-way jumper link	095.08	095.08.0	095.08	095.08.0
Identification tag	095.00.4			
Modules (see table below)	99.80			
Marker tag holder	097.00			
Sheet of marker tags for plastic retaining and release clip 095.91.3, 48 tags, 6 x 12 mm, for CEMBRE thermal transfert printer	060.48			
<b>Technical data</b>				
Rated values	10 A - 250 V*			
Dielectric strength between coil and contacts (1.2/50 μs)	6 kV		2 kV	
Protection category	IP 20			
Ambient temperature	°C -40...+70 (see diagram L95)			
Screw torque	Nm	0.5		
Wire strip length	mm 7			
Max. wire size for 95.83.3 and 95.85.3 sockets	solid wire		stranded wire	
	mm <sup>2</sup>	1 x 6 / 2 x 2.5		1 x 4 / 2 x 2.5
	AWG	1 x 10 / 2 x 14		1 x 12 / 2 x 14

\* For currents > 10 A, contact terminals must be connected in parallel (21 with 11, 24 with 14, 22 with 12).  
With the relay 40.51 the change-over contact will be 21-12-14.

**L 95 - Total socket current v ambient temperature**

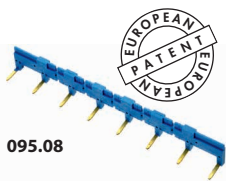
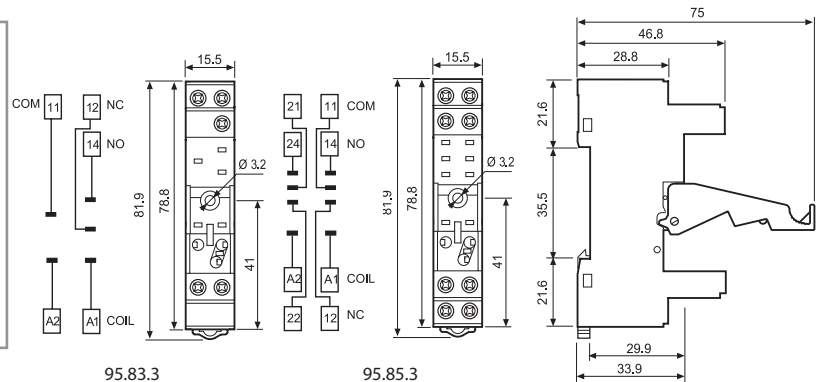
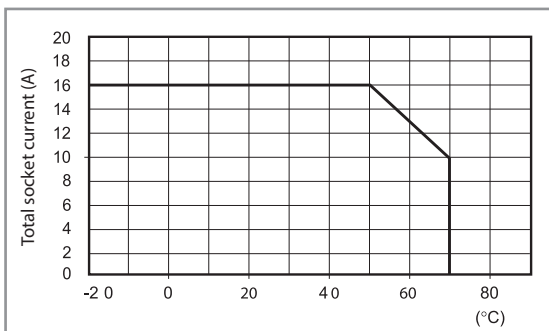

095.08



8-way jumper link for 95.83.3 and 95.85.3 sockets	095.08 (blue)	095.08.0 (black)
Rated values	10 A - 250 V	

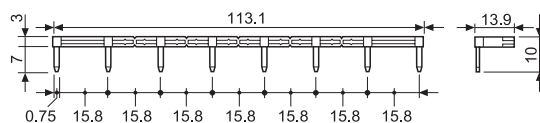

99.80

Approvals  
(according to type):



\* Modules in Black housing are available on request.

Green LED is standard.  
Red LED available on request.

99.80 coil indication and EMC suppression modules for 95.83.3 and 95.85.3 sockets		Blue*
Diode (+A1, standard polarity)	(6...220)V DC	99.80.3.000.00
LED	(6...24)V DC/AC	99.80.0.024.59
LED	(28...60)V DC/AC	99.80.0.060.59
LED	(110...240)V DC/AC	99.80.0.230.59
LED + Diode (+A1, standard polarity)	(6...24)V DC	99.80.9.024.99
LED + Diode (+A1, standard polarity)	(28...60)V DC	99.80.9.060.99
LED + Diode (+A1, standard polarity)	(110...220)V DC	99.80.9.220.99
LED + Varistor	(6...24)V DC/AC	99.80.0.024.98
LED + Varistor	(28...60)V DC/AC	99.80.0.060.98
LED + Varistor	(110...240)V DC/AC	99.80.0.230.98
RC circuit	(6...24)V DC/AC	99.80.0.024.09
RC circuit	(28...60)V DC/AC	99.80.0.060.09
RC circuit	(110...240)V DC/AC	99.80.0.230.09
Residual current by-pass*	(110...240)V AC	99.80.8.230.07

\* Additional 0.9 W power dissipation



A

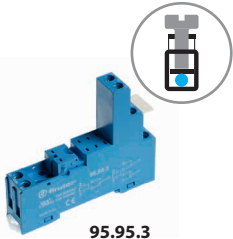

95.95.3

Approvals  
(according to type):



095.91.3

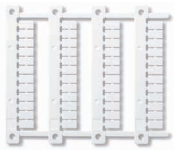

060.48

<b>Screw (Box clamp) terminal socket</b> panel or 35 mm rail mount	<b>95.93.3 (blue)</b>	<b>95.93.30 (black)</b>	<b>95.95.3 (blue)</b>	<b>95.95.30 (black)</b>
For relay type	40.31		40.51, 40.52, 40.61, 40.62	
<b>Accessories</b>				
Metal retaining clip	095.71			
Plastic retaining and release clip (supplied with socket - packaging code SPA)	095.91.3	095.91.30	095.91.3	095.91.30
8-way jumper link	095.08	095.08.0	095.08	095.08.0
Identification tag	095.00.4			
Modules (see table below)	99.80			
Sheet of marker tags for plastic retaining and release clip 095.91.3 and for marker tag holder 097.00, 48 tags, 6 x 12 mm, for CEMBRE thermal transfer printers	060.48			
<b>Technical data</b>				
Rated values	10 A - 250 V*			
Dielectric strength between coil and contacts (1.2/50 μs)	6 kV			
Protection category	IP 20			
Ambient temperature	°C -40...+70 (see diagram L95)			
Screw torque	Nm	0.5		
Wire strip length	mm	8		
Max. wire size for 95.93.3 and 95.95.3 sockets		solid wire		stranded wire
	mm <sup>2</sup>	1 x 6 / 2 x 2.5		1 x 4 / 2 x 2.5
	AWG	1 x 10 / 2 x 14		1 x 12 / 2 x 14

\* For currents > 10 A, contact terminals must be connected in parallel (21 with 11, 24 with 14, 22 with 12).  
With the relay 40.51 the change-over contact will be 21-12-14.

**L 95 - Total socket current v ambient temperature**

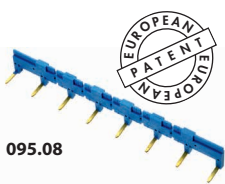
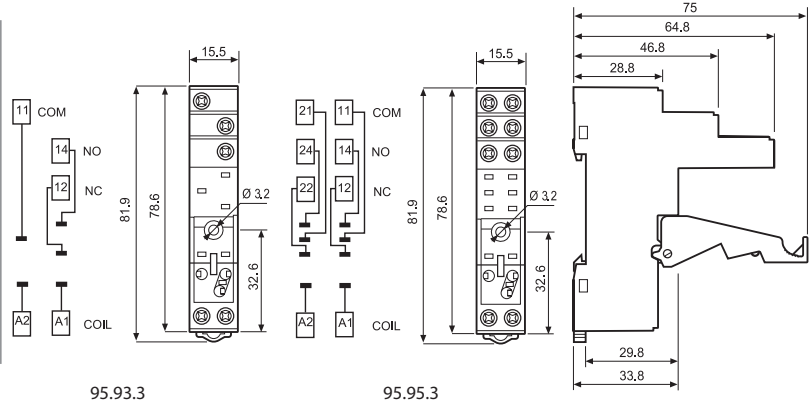
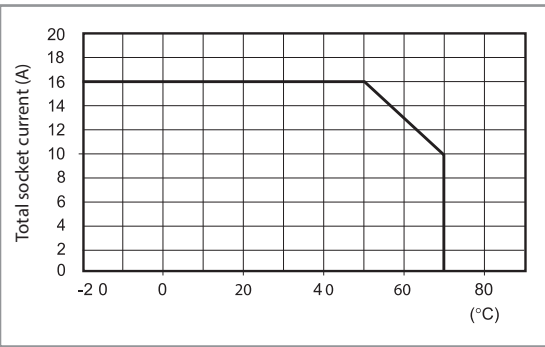

095.08

<b>8-way jumper link</b> for 95.93.3 and 95.95.3 sockets	<b>095.08 (blue)</b>	<b>095.08.0 (black)</b>
Rated values	10 A - 250 V	

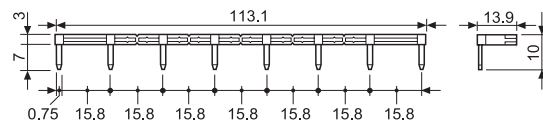

99.80  
Approvals  
(according to type):



\* Modules in Black housing are available on request.

Green LED is standard. Red LED available on request.

<b>99.80 coil indication and EMC suppression modules</b> for 95.93.3 and 95.95.3 sockets		<b>Blue*</b>
Diode (+A1, standard polarity)	(6...220)V DC	99.80.3.000.00
LED	(6...24)V DC/AC	99.80.0.024.59
LED	(28...60)V DC/AC	99.80.0.060.59
LED	(110...240)V DC/AC	99.80.0.230.59
LED + Diode (+A1, standard polarity)	(6...24)V DC	99.80.9.024.99
LED + Diode (+A1, standard polarity)	(28...60)V DC	99.80.9.060.99
LED + Diode (+A1, standard polarity)	(110...220)V DC	99.80.9.220.99
LED + Varistor	(6...24)V DC/AC	99.80.0.024.98
LED + Varistor	(28...60)V DC/AC	99.80.0.060.98
LED + Varistor	(110...240)V DC/AC	99.80.0.230.98
RC circuit	(6...24)V DC/AC	99.80.0.024.09
RC circuit	(28...60)V DC/AC	99.80.0.060.09
RC circuit	(110...240)V DC/AC	99.80.0.230.09
Residual current by-pass*	(110...240)V AC	99.80.8.230.07

\* Additional 0.9 W power dissipation



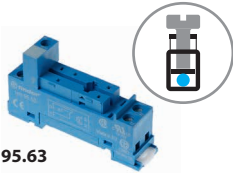

95.63

Approvals  
(according to type):



95.65

Approvals  
(according to type):



<b>Screw terminal (Box clamp) socket panel or 35 mm rail mount</b>	<b>95.63</b>	<b>95.65</b>
For relay type	40.31	40.51, 40.52, 40.61, 40.62
<b>Accessories</b>		
Metal retaining clip	095.71	
8-way jumper link	095.08	095.08
Modules (see table below)	99.01	—
<b>Technical data</b>		
Rated values	10 A - 250 V*	
Dielectric strength between coil and contacts (1.2/50 μs)	6 kV	2 kV
Protection category	IP 20	
Ambient temperature	°C -40...+70 (see diagram L95)	
⊕ Screw torque	Nm 0.5	
Wire strip length	mm 7	
Max. wire size for 95.63 and 95.65 sockets	solid wire	stranded wire
	mm <sup>2</sup>	1 x 6 / 2 x 2.5
	AWG	1 x 10 / 2 x 14

\* For currents > 10 A, contact terminals must be connected in parallel (21 with 11, 24 with 14, 22 with 12).  
With the relay 40.51 the change-over contact will be 21-12-14.

**L 95 - Total socket current v ambient temperature**

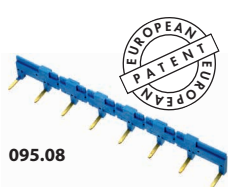
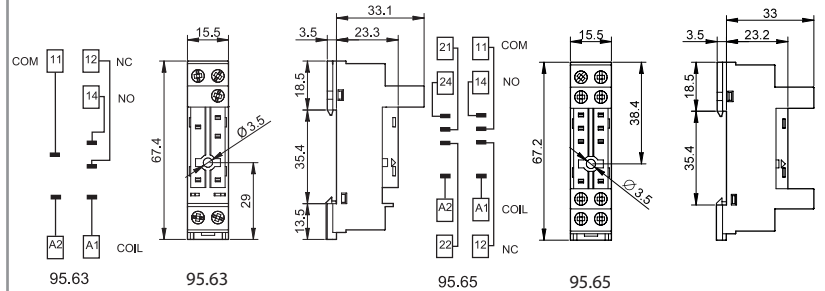
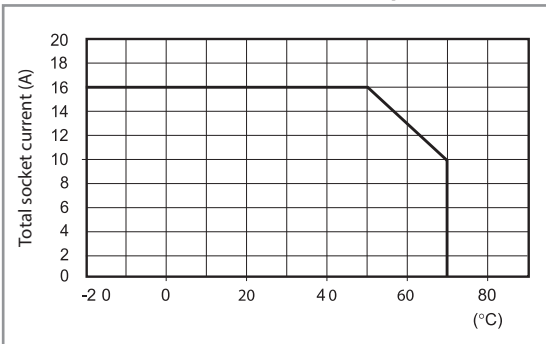

095.08



<b>8-way jumper link for 95.63 and 95.65 sockets</b>	<b>095.08 (blue)</b>
Rated values	10 A - 250 V

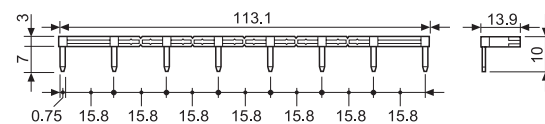

**99.01 coil indication and EMC suppression modules for type 95.63 socket**

		<b>Blue*</b>
Diode (+A1, standard polarity)	(6...220)V DC	99.01.3.000.00
Diode (+A2, non-standard polarity)	(6...220)V DC	99.01.2.000.00
LED	(6...24)V DC/AC	99.01.0.024.59
LED	(28...60)V DC/AC	99.01.0.060.59
LED	(110...240)V DC/AC	99.01.0.230.59
LED + Diode (+A1, standard polarity)	(6...24)V DC	99.01.9.024.99
LED + Diode (+A1, standard polarity)	(28...60)V DC	99.01.9.060.99
LED + Diode (+A1, standard polarity)	(110...220)V DC	99.01.9.220.99
LED + Diode (+A2, non-standard polarity)	(6...24)V DC	99.01.9.024.79
LED + Diode (+A2, non-standard polarity)	(28...60)V DC	99.01.9.060.79
LED + Diode (+A2, non-standard polarity)	(110...220)V DC	99.01.9.220.79
LED + Varistor	(6...24)V DC/AC	99.01.0.024.98
LED + Varistor	(28...60)V DC/AC	99.01.0.060.98
LED + Varistor	(110...240)V DC/AC	99.01.0.230.98
RC circuit	(6...24)V DC/AC	99.01.0.024.09
RC circuit	(28...60)V DC/AC	99.01.0.060.09
RC circuit	(110...240)V DC/AC	99.01.0.230.09
Residual current by-pass*	(110...240)V AC	99.01.8.230.07

\* Additional 0.9 W power dissipation



99.01

Approvals  
(according to type):



\* Modules in Black housing are available on request.

Green LED is standard.  
Red LED available on request.

A



95.13.2



95.15.2

Approvals  
(according to type):



PCB socket	95.13.2 (blue)	95.13.20 (black)	95.15.2 (blue)	95.15.20 (black)
For relay type	40.31		40.51, 40.52, 40.61, 40.62	
<b>Accessories</b>				
Metal retaining clip (supplied with socket - packaging code SMA)			095.51	
Plastic retaining clip			095.52	
<b>Technical data</b>				
Rated values	12 A - 250 V		10 A - 250 V*	
Dielectric strength between coil and contacts (1.2/50 μs)	6 kV			
Protection category	IP 20			
Ambient temperature	°C -40...+70			

\* For currents > 10 A, contact terminals must be connected in parallel (21 with 11, 24 with 14, 22 with 12).  
With the relay 40.51 the change-over contact will be 21-12-14.

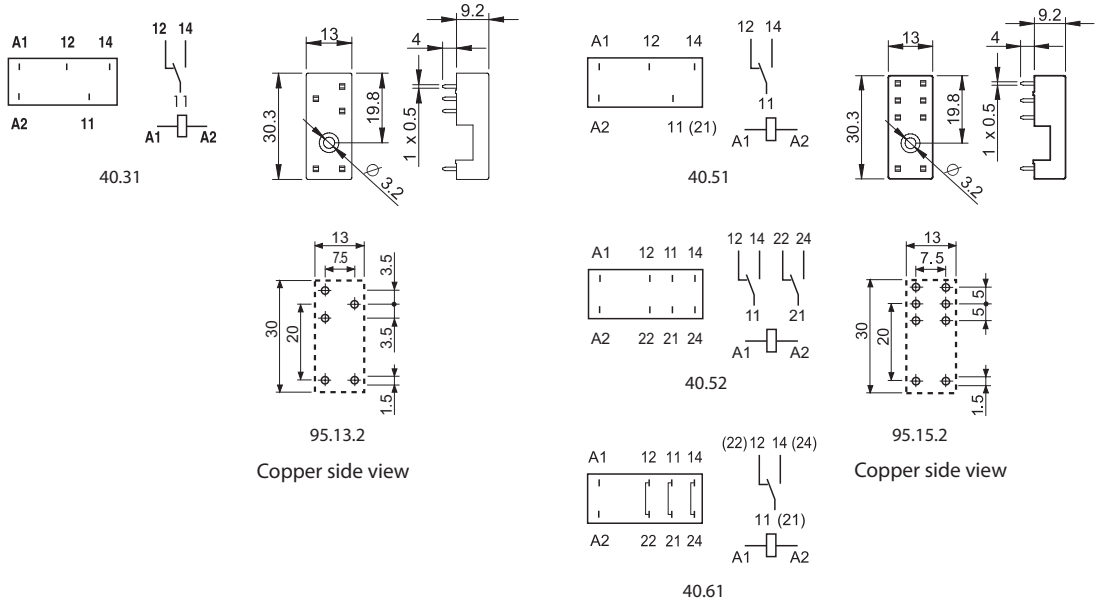

### Packaging codes

How to code and identify retaining clip and packaging options for sockets.

Example:



A Standard packaging

SM Metal retaining clip  
SP Plastic retaining clip

# Low profile PCB relays 3 - 5 - 8 - 12 - 16 A



Medical and  
dentistry



Industrial robots



Building  
automation



Control  
systems



Timers and  
lighting  
controls



Door and  
gate openers

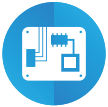

Electronic circuit  
boards



Vending  
machines





### 1 & 2 Pole - Low profile (15.7 mm height)

#### Type 41.31

- 1 Pole 12 A (3.5 mm pin pitch)

#### Type 41.52

- 2 Pole 8 A (5.0 mm pin pitch)

#### Type 41.61

- 1 Pole 16 A (5.0 mm pin pitch)

#### PCB mount

- direct or via PCB socket

#### 35 mm rail mount

- via screw and screwless sockets

- AC and DC coils
- 8 mm, 6 kV (1.2/50 µs) isolation, coil-contacts
- Cadmium Free contact materials
- Flux proof: RT II standard, (RT III option)

\*\*With the AgSnO<sub>2</sub> material the maximum peak current is 80 A - 5 ms on NO contact.

FOR UL RATINGS SEE:

"General technical information" page V

For outline drawing see page 9

#### Contact specification

Contact configuration

1 CO (SPDT)

2 CO (DPDT)

1 CO (SPDT)

Rated current/

Maximum peak current

A

12/25

8/15

16/30\*\*

Rated voltage/

Maximum switching voltage

V AC

250/400

250/400

250/400

Rated load AC1

VA

3000

2000

4000

Rated load AC15 (230 V AC)

VA

600

400

750

Single phase motor rating (230 V AC)

kW

0.5

0.3

0.5

Breaking capacity DC1: 24/110/220 V

A

12/0.3/0.12

8/0.3/0.12

16/0.3/0.12

Minimum switching load

mW (V/mA)

300 (5/5)

300 (5/5)

300 (5/5)

Standard contact material

AgNi

AgNi

AgNi

#### Coil specification

Nominal voltage (U<sub>N</sub>)

V AC (50/60 Hz)

24 - 230

24 - 230

24 - 230

V DC

5 - 6 - 12 - 24 - 48 - 60 - 110

5 - 6 - 12 - 24 - 48 - 60 - 110

5 - 6 - 12 - 24 - 48 - 60 - 110

Rated power AC/DC

VA (50 Hz)/W

0.75/0.4

0.75/0.4

0.75/0.4

Operating range

AC

(0.8...1.1)U<sub>N</sub>

(0.8...1.1)U<sub>N</sub>

(0.8...1.1)U<sub>N</sub>

DC

(0.7...1.5)U<sub>N</sub>

(0.7...1.5)U<sub>N</sub>

(0.7...1.5)U<sub>N</sub>

Holding voltage

AC/DC

0.8/0.4 U<sub>N</sub>

0.8/0.4 U<sub>N</sub>

0.8/0.4 U<sub>N</sub>

Must drop-out voltage

AC/DC

0.15/0.1 U<sub>N</sub>

0.15/0.1 U<sub>N</sub>

0.15/0.1 U<sub>N</sub>

#### Technical data

Mechanical life AC/DC

cycles

10 · 10<sup>6</sup> / 10 · 10<sup>6</sup>

10 · 10<sup>6</sup> / 10 · 10<sup>6</sup>

10 · 10<sup>6</sup> / 10 · 10<sup>6</sup>

Electrical life at rated load AC1

cycles

60 · 10<sup>3</sup>

60 · 10<sup>3</sup>

50 · 10<sup>3</sup>

Operate/release time

ms

8/6

8/6

8/6

Insulation between coil and contacts (1.2/50 µs)

kV

6 (8 mm)

6 (8 mm)

6 (8 mm)

Dielectric strength between open contacts

V AC

1000

1000

1000

Ambient temperature range AC/DC

°C

-40...+70/-40...+85

-40...+70/-40...+85

-40...+70/-40...+85

Environmental protection

RT II

RT II

RT II

Approvals (according to type)



- 3.5 mm contact pin pitch
- 1 Pole 12 A
- PCB direct or via socket

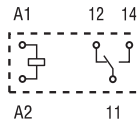

Copper side view



- 5.0 mm contact pin pitch
- 2 Pole 8 A
- PCB direct or via socket

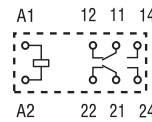

Copper side view



- 5.0 mm contact pin pitch
- 1 Pole 16 A
- PCB direct or via socket

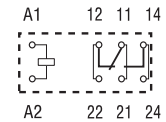

Copper side view

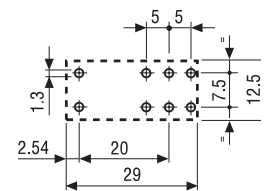
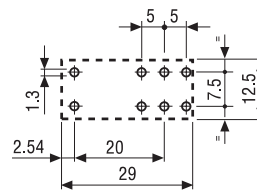
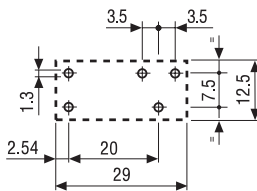

A

**1 & 2 Pole - Polarized bistable, Low profile (15.7 mm height)**

**Type 41.52**

- 2 Pole 8 A (5.0 mm pin pitch)

**Type 41.61**

- 1 Pole 16 A (5.0 mm pin pitch)

**Printed Circuit mount**

- Polarized bistable relay with 2 coils
- 10 mm, 6 kV (1.2/50  $\mu$ s) isolation, coil-contacts
- Cadmium Free contact materials
- Flux proof: RT II standard

**41.52.6.xxx**



- 2 Pole, 8 A
- PCB direct mount

**41.61.6.xxx**



- 1 Pole, 16 A
- PCB direct mount

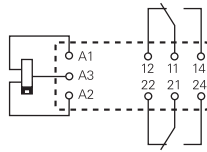

2 coil version:  
A3(+) A2 (-) = Set  
A3(+) A1 (-) = Reset

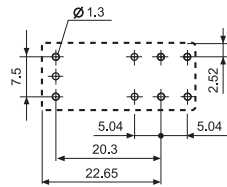

Copper side view

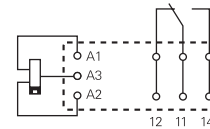

2 coil version:  
A3(+) A2 (-) = Set  
A3(+) A1 (-) = Reset

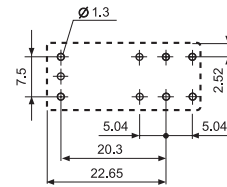

Copper side view

For outline drawing see page 9

**Contact specification**

Contact configuration		2 CO (DPDT)	1 CO (SPDT)
Rated current/ Maximum peak current ( $I_N/I_{max}$ )	A	8/15	16/30
Rated voltage/ Maximum switching voltage ( $U_N/U_{max}$ )	V AC	250/400	250/400
Rated load AC1	VA	2000	4000
Rated load AC15 (230 V AC)	VA	350	750
Single phase motor rating (230 V AC)	kW	0.37	0.55
Breaking capacity DC1: 24/110/220 V	A	8/0.3/0.12	16/0.3/0.12
Minimum switching load	mW (V/mA)	500 (5/100)	500 (5/100)
Standard contact material		AgSnO <sub>2</sub>	AgSnO <sub>2</sub>

**Coil specification**





Nominal voltage ( $U_N$ )	V DC	5 - 12 - 24	5 - 12 - 24
Rated power ( $P_N$ )	W	0.65	0.65
Operating range	DC	(0.7...1.1) $U_N$	(0.7...1.1) $U_N$
Min. impulse duration	ms	20	20
Max. impulse duration	s	30	30

**Technical data**

Mechanical life DC	cycles	5 · 10 <sup>6</sup>	5 · 10 <sup>6</sup>
Electrical life at rated load AC1	cycles	30 · 10 <sup>3</sup>	30 · 10 <sup>3</sup>
Operate/release time	ms	10/5	10/10
Insulation between coil and contacts (1.2/50 $\mu$ s)	kV	6 (10 mm)	6 (10 mm)
Dielectric strength between open contacts	V AC	1000	1000
Ambient temperature range	°C	-40...+85	-40...+85
Environmental protection		RT II	RT II

**Approvals** (according to type)

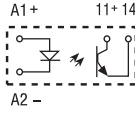
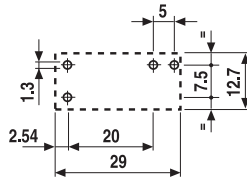
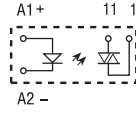
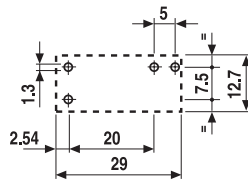

<p><b>Solid State Relays</b></p> <p><b>Printed circuit mount:</b> - direct or via PCB socket</p> <p><b>35 mm rail mount:</b> - via screw or screwless sockets</p> <ul style="list-style-type: none"> <li>• Single circuit output switching options                     <ul style="list-style-type: none"> <li>- 5 A 24 V DC</li> <li>- 3 A 240 V AC</li> </ul> </li> <li>• Silent, high speed switching with long electrical life</li> <li>• LED indicator</li> <li>• Low profile (15.7 mm)</li> <li>• Wash tight: RT III</li> <li>• 2500 V AC insulation, input-output</li> </ul>	<p><b>41.81 - 9024</b></p>  <ul style="list-style-type: none"> <li>• 5 A, 24 V DC output switching</li> <li>• PCB or 93 Series sockets</li> </ul>	<p><b>41.81 - 8240</b></p>  <ul style="list-style-type: none"> <li>• 3 A, 240 V AC output switching</li> <li>• Zero crossing switching</li> <li>• PCB or 93 Series sockets</li> </ul>			
	  <p>Copper side view</p>	  <p>Copper side view</p>			
	For outline drawing see page 9				
<b>Output circuit</b>					
Contact configuration	1 NO (SPST-NO)				
Rated current/ Maximum peak current (10 ms)	A	5/40	3/40		
Rated voltage/ Maximum blocking voltage	V	(24/35)DC	(240/—)AC		
Switching voltage range	V	(1.5...24)DC	(12...275)AC		
Repetitive peak off-state voltage	V <sub>pk</sub>	—	600		
Minimum switching current	mA	1	50		
Max. "OFF-state" leakage current	mA	0.01	1		
Max. "ON-state" voltage drop	V	0.3	1.1		
<b>Input circuit</b>					
Nominal voltage	V DC	12	24	12	24
Operating range	V DC	8...17	14...32	8...17	14...32
Control current	mA	5.5	9	8.8	9
Release voltage	V DC	4	9	4	9
Impedance	Ω	1550	2600	1030	2600
<b>Technical data</b>					
Operate/release time	ms	0.05/0.25		10/10	
Dielectric strength between input/output	V AC	2500		2500	
Ambient temperature range	°C	-20...+60		-20...+60	
Environmental protection		RT III		RT III	
<b>Approvals</b> (according to type)					

## Ordering information

### Electromechanical relay (EMR)

Example: 41 series low-profile PCB relay, 2 CO (DPDT), 24 V DC coil.

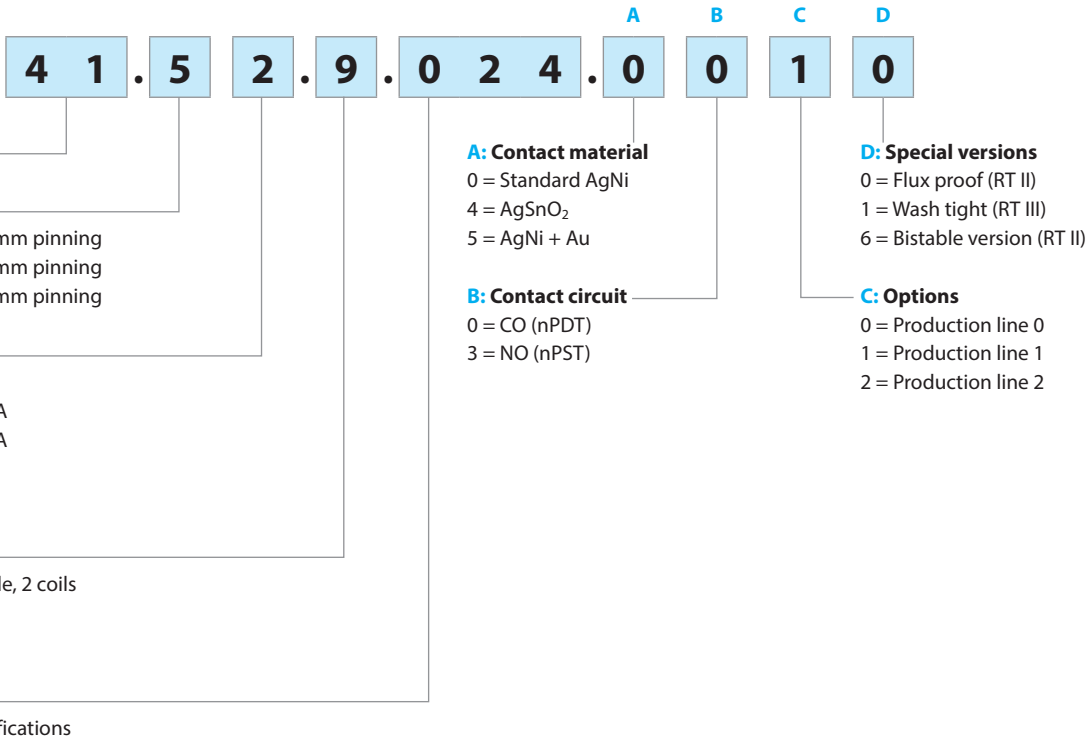

**Selecting features and options: only combinations in the same row are possible.**  
Preferred selections for best availability are shown in **bold**.

Type	Coil version	A	B	C	D
41.31	DC	<b>0</b> - 4 - 5	<b>0</b> - 3	<b>1</b>	<b>0</b> - 1
41.52	DC	<b>0</b> - 5	<b>0</b> - 3	<b>1</b>	<b>0</b> - 1
41.61	DC	<b>0</b> - 4	<b>0</b> - 3	<b>1</b>	<b>0</b> - 1
41.31/61	DC (12-24V)	<b>0</b>	<b>0</b>	<b>2</b>	<b>0</b>
41.31/52/61	AC	<b>0</b>	<b>0</b>	<b>0</b>	<b>0</b>
41.52	DC bistable	4	<b>0</b>	<b>1</b>	<b>6</b>
41.61	DC bistable	4	<b>0</b> - 3	<b>1</b>	<b>6</b>

### Solid state relay (SSR)

Example: 41 series SSR relay, 5 A output, 24 V DC supply.

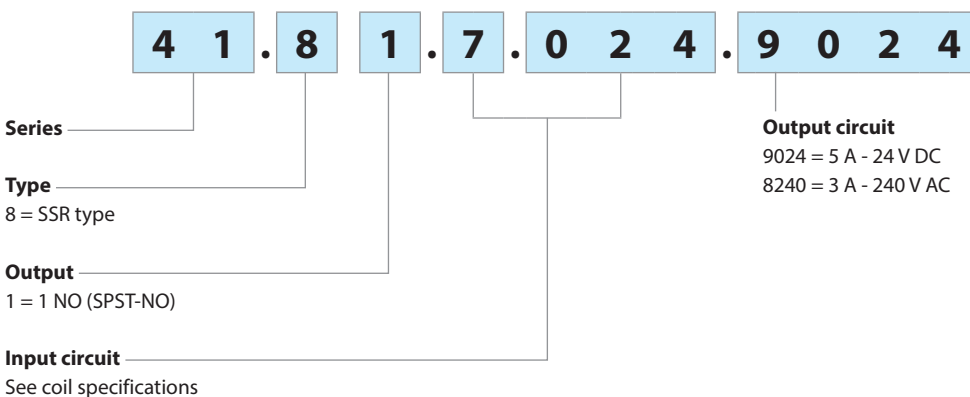



*Electromechanical relay*

A

**Technical data**

Insulation according to EN 61810-1							
		1 pole		1 pole bistable	2 pole		2 pole bistable
Nominal voltage of supply system	V AC	230/400		230/400	230/400		230/400
Rated insulation voltage	V AC	250	400	250	250	400	250
Pollution degree		3	2	2	3	2	2
Insulation between coil and contact set							
Type of insulation		Reinforced (8 mm)		Reinforced (10 mm)	Reinforced (8 mm)		Reinforced (10 mm)
Overvoltage category		III		III	III		III
Rated impulse voltage	kV (1.2/50 µs)	6		6	6		6
Dielectric strength	V AC	4000		4000	4000		4000
Insulation between adjacent contacts							
Type of insulation		—		—	Basic		Basic
Overvoltage category		—		—	III		III
Rated impulse voltage	kV (1.2/50 µs)	—		—	4		4
Dielectric strength	V AC	—		—	2000		2000
Insulation between open contacts							
Type of disconnection		Micro-disconnection			Micro-disconnection		
Dielectric strength	V AC/kV (1.2/50 µs)	1000/1.5			1000/1.5		
Insulation between coil terminals							
Rated impulse voltage (surge) differential mode (according to EN 61000-4-5)	kV (1.2/50 µs)	2					
Other data							
Bounce time: NO/NC	ms	4/6 (monostable) - 2/10 (bistable)					
Vibration resistance (5...55)Hz: NO/NC	g	15/2 (monostable) - 5/3 (bistable)					
Shock resistance	g	16 (monostable) - 10 (bistable)					
Power lost to the environment	without contact current	W	0.4 (monostable)				
	with rated current	W	1.7 (41.31)	1.2 (41.52)	1.8 (41.61)		
Recommended distance between relays mounted on PCB	mm	≥ 5					

### Contact specification

**F 41 - Electrical life (AC) v contact current (monostable)**

Types 41.31/61

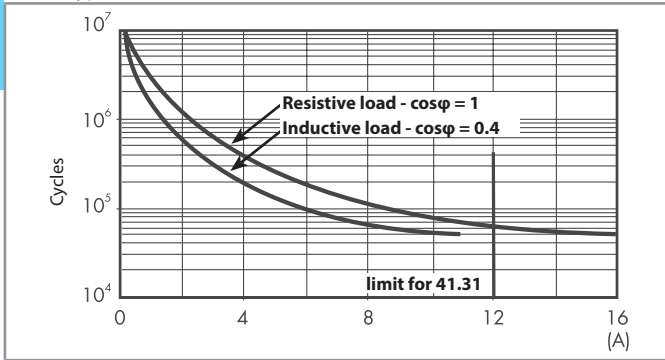

**F 41 - Electrical life (AC) v contact current (monostable)**

Type 41.52

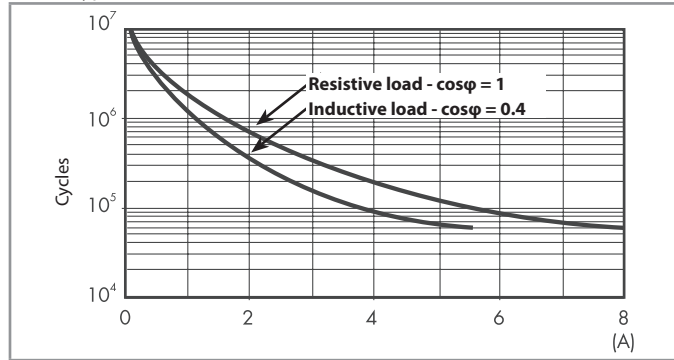

**F 41 - Electrical life (AC) v contact current (bistable)**

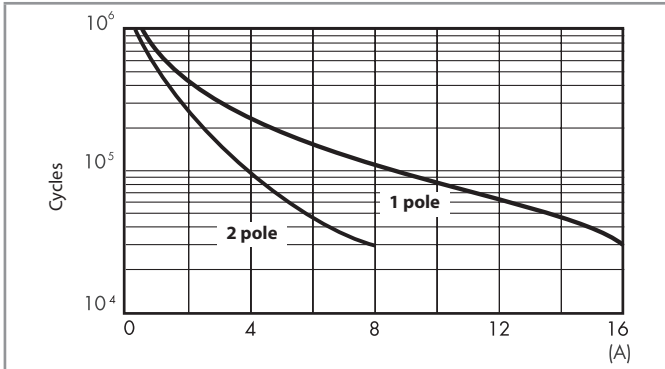

**H 41 - Maximum DC1 breaking capacity**

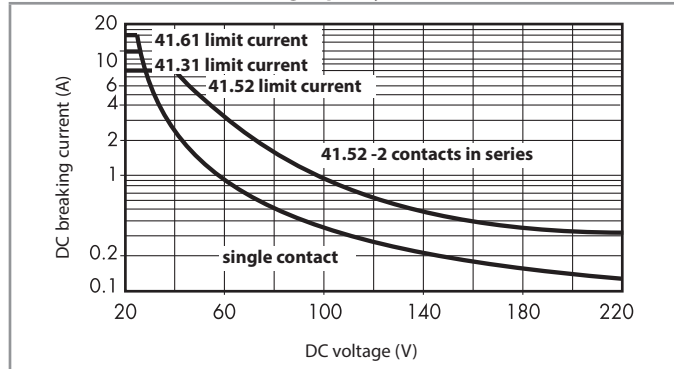

- When switching a resistive load (DC1) having voltage and current values under the curve, an electrical life of  $\geq 100 \cdot 10^3$  can be expected.
- In the case of DC13 loads, the connection of a diode in parallel with the load will permit a similar electrical life as for a DC1 load. Note: the release time for the load will be increased.

### Coil specifications

**AC coil data**

Nominal voltage $U_N$ V	Coil code	Operating range		Resistance R $\Omega$	Rated coil consumption I at $U_N$ mA
		$U_{min}$ V	$U_{max}$ V		
24	8.024	19.2	26.4	350	31.6
230	8.230	184	253	32500	3.2

**DC coil data**

Nominal voltage $U_N$ V	Coil code	Operating range		Resistance R $\Omega$	Rated coil consumption I at $U_N$ mA
		$U_{min}$ V	$U_{max}$ V		
5	9.005	3.5	7.5	62	80
6	9.006	4.2	9	90	66.7
12	9.012	8.4	18	360	33.3
24	9.024	16.8	36	1440	16.7
48	9.048	33.6	72	5760	8.3
60	9.060	42	90	9000	6.6
110	9.110	77	165	24200	4.5

**DC coil data (bistable)**

Nominal voltage $U_N$ V	Coil code	Operating range			Resistance R $\Omega$	Rated coil power I at $U_N$ mW
		Set $U_{min}$ V	Reset $U_{min}$ V	Set/Reset $U_{max}$ V		
5	6.005	3.5	3.5	5.5	38	650
12	6.012	8.4	8.4	13.2	220	650
24	6.024	16.8	16.8	26.4	885	650

**R 41 - AC coil operating range v ambient temperature**

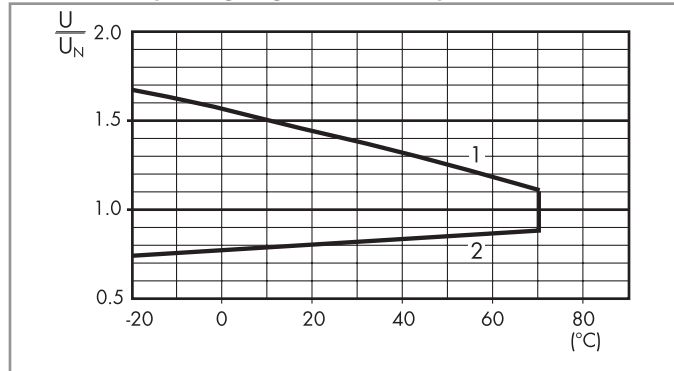

- 1 - Max. permitted coil voltage.
- 2 - Min. pick-up voltage with coil at ambient temperature.

**R 41 - DC coil operating range v ambient temperature**

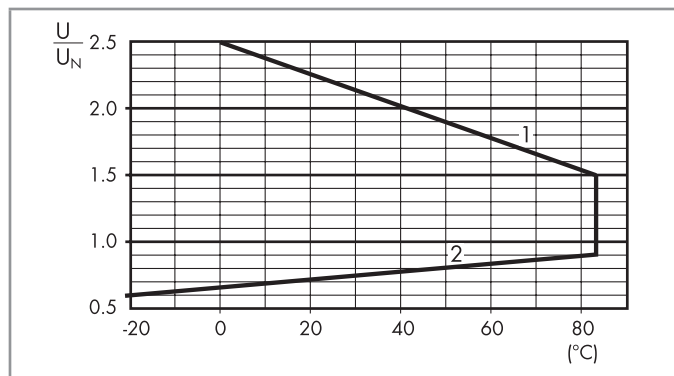

- 1 - Max. permitted coil voltage.
- 2 - Min. pick-up voltage with coil at ambient temperature.

**Solid state relay**

**Technical data**

Other data		41.81 - 9024	41.81 - 8240
Power lost to the environment	without current	W 0.25	0.25
	with maximum current	W 1.75	3.5

**Input specification**

**Input data - DC types**

Nominal voltage $U_N$	Input code	Operating range		Release voltage	Impedance	Control current I at $U_N$
		$U_{min}$	$U_{max}$			
V		V	V	V	$\Omega$	mA
12	7.012	8	17	4	1550	5.5
24	7.024	14	32	9	2600	9

**Output specification**

**L 41 - Output current v ambient temperature**  
SSR - 5 A DC output types

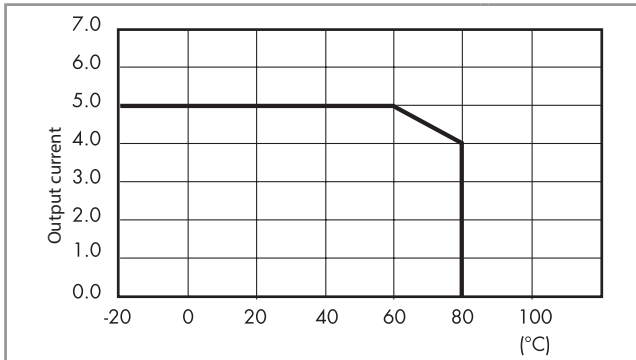

**L 41 - Output current v ambient temperature**  
SSR - 3 A AC output types

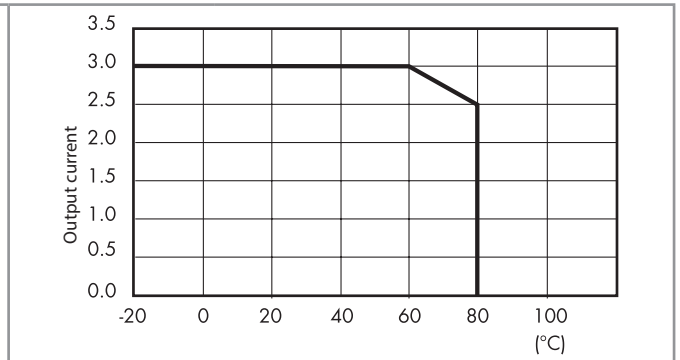

**Outline drawings**

Types 41.31/52/61

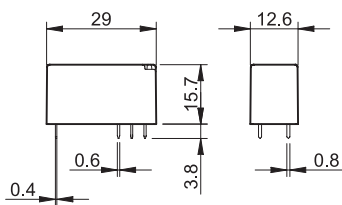

Types 41.52.6.xxx/41.61.6.xxx

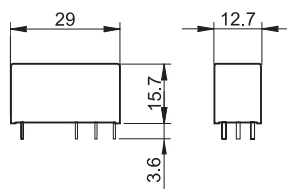

Types 41.81-9024/41.81-8240

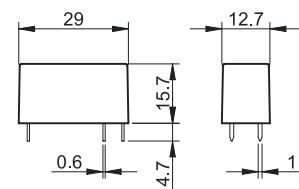

A



93.02

Approvals  
(according to type):



**Screw terminal socket 35 mm (EN 60715) mounting**

Supply voltage	Relay type	Socket type	
6 V AC/DC	41.52.9.005.0010 or 41.61.9.005.0010	93.02.0.024	
12 V AC/DC	41.52.9.012.0010 or 41.61.9.012.0010	93.02.0.024	
24 V AC/DC	41.52/61.9.024.0010 or 41.81.7.024.xxxx	93.02.0.024	
60 V AC/DC	41.52.9.060.0010 or 41.61.9.060.0010	93.02.0.060	
(110...125)V AC/DC	41.52.9.110.0010 or 41.61.9.110.0010	93.02.0.125	
(220...240)V AC/DC	41.52.9.110.0010 or 41.61.9.110.0010	93.02.0.240	
(230...240)V AC	41.52.9.110.0010 or 41.61.9.110.0010	93.02.8.230	
6 V DC	41.52.9.005.0010 or 41.61.9.005.0010	93.02.7.024	
12 V DC	41.52/61.9.012.0010 or 41.81.7.012.xxxx	93.02.7.024	
24 V DC	41.52/61.9.024.0010 or 41.81.7.024.xxxx	93.02.7.024	
48 V DC	41.52.9.048.0010 or 41.61.9.048.0010	93.02.7.060	
60 V DC	41.52.9.060.0010 or 41.61.9.060.0010	93.02.7.060	
<b>Accessories</b>			
8-way jumper link	093.08 (see specification next page)		
Plastic separator	093.01 (see specification next page)		
Sheet of marker tags, 48 tags	060.48 (see specification next page)		
<b>Technical data</b>			
Rated values	10 A - 250 V*		
Dielectric strength	6 kV (1.2/50 μs) between coil and contacts		
Protection category	IP 20		
Ambient temperature (U <sub>N</sub> ≤ 60 V / > 60 V)	°C -40...+70/-40...+55		
Screw torque	Nm	0.5	
Wire strip length	mm	8	
Max. wire size for 93.02 socket	solid wire	stranded wire	
	mm <sup>2</sup>	1 x 6 / 2 x 2.5	1 x 4 / 2 x 2.5
	AWG	1 x 10 / 2 x 14	1 x 12 / 2 x 14

\* For currents > 10 A, contact terminals must be connected in parallel (21 with 11, 24 with 14, 22 with 12).

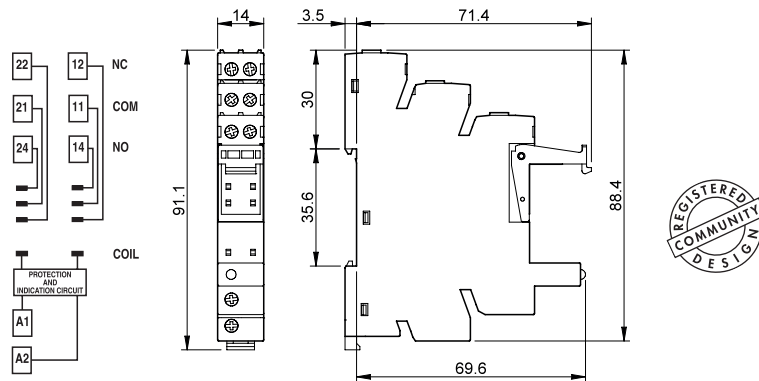

Note: Not for bistable relays



93.52

Approvals  
(according to type):

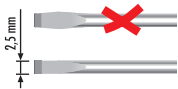

**Screw terminal socket 35 mm (EN 60715) mounting**

Supply voltage	Relay type	Socket type
6 V AC/DC	41.52.9.005.0010 or 41.61.9.005.0010	93.52.0.024
12 V AC/DC	41.52.9.012.0010 or 41.61.9.012.0010	93.52.0.024
24 V AC/DC	41.52/61.9.024.0010 or 41.81.7.024.xxxx	93.52.0.024
60 V AC/DC	41.52.9.060.0010 or 41.61.9.060.0010	93.52.0.060
(110...125)V AC/DC	41.52.9.110.0010 or 41.61.9.110.0010	93.52.0.125
(220...240)V AC/DC	41.52.9.110.0010 or 41.61.9.110.0010	93.52.0.240
(230...240)V AC	41.52.9.110.0010 or 41.61.9.110.0010	93.52.8.230
6 V DC	41.52.9.005.0010 or 41.61.9.005.0010	93.52.7.024
12 V DC	41.52/61.9.012.0010 or 41.81.7.012.xxxx	93.52.7.024
24 V DC	41.52/61.9.024.0010 or 41.81.7.024.xxxx	93.52.7.024
48 V DC	41.52.9.048.0010 or 41.61.9.048.0010	93.52.7.060
60 V DC	41.52.9.060.0010 or 41.61.9.060.0010	93.52.7.060

**Accessories**

8-way jumper link	093.08 (see table below)
Plastic separator	093.01 (see table below)
Sheet of marker tags, 48 tags	060.48 (see table below)

**Technical data**

Rated values	10 A - 250 V*		
Dielectric strength	6 kV (1.2/50 μs) between coil and contacts		
Protection category	IP 20		
Ambient temperature (U <sub>N</sub> ≤ 60 V / > 60 V)	°C	-40...+70/-40...+55	
Wire strip length	mm	8	
Max. wire size for 93.52 socket	solid wire	stranded wire	
	mm <sup>2</sup>	1 x 2.5	1 x 2.5
	AWG	1 x 14	1 x 14

\* For currents > 10 A, contact terminals must be connected in parallel (21 with 11, 24 with 14, 22 with 12).

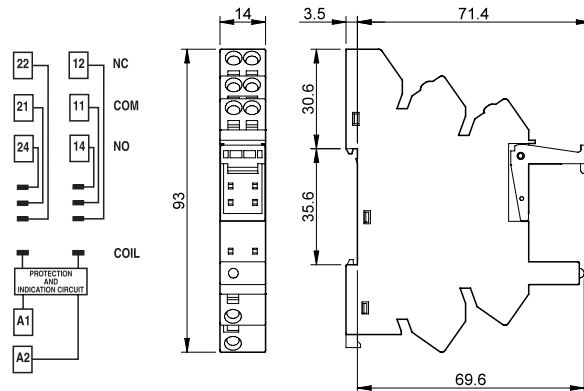

Note: Not for bistable relays

**Accessories**



093.08

Approvals  
(according to type):



<b>8-way jumper link</b> for 93.02 and 93.52 sockets	093.08 (blue)	093.08.0 (black)	093.08.1 (red)
Rated values	10 A - 250 V		

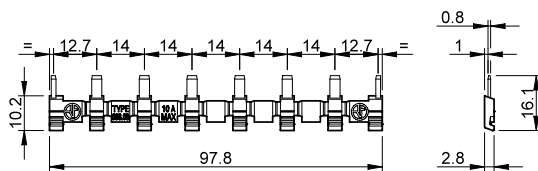

<b>Plastic separator</b> for 93.02 and 93.52 sockets	093.01
--	--------

Thickness 2 mm, required at the start and the end of a group of interfaces.

Can be used for visual separation group, must be used for:

- protective separation of different voltages of neighbouring PLC interfaces according to VDE 0106-101
- protection of cut jumper links

<b>Sheet of marker tags (CEMBRE Thermal transfer printers)</b> , plastic, 48 tags, 6 x 12 mm	060.48
--	--------



093.01

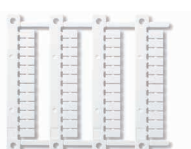

060.48

A



95.13.2



95.15.2

Approvals  
(according to type):



PCB socket	95.13.2 (blue)	95.13.20 (black)	95.15.2 (blue)	95.15.20 (black)
For relay type	41.31		41.52, 41.61, 41.81 <sup>(1)</sup>	
<b>Accessories</b>				
Plastic retaining clip (supplied with socket - packaging code SLA)			095.42.30	
Metal retaining clip			095.41.3	
<b>Technical data</b>				
Rated values	10 A - 250 V*			
Dielectric strength	6 kV (1.2/50 μs) between coil and contacts			
Protection category	IP 20			
Ambient temperature	°C -40...+70			

\* For currents > 10 A, contact terminals must be connected in parallel (21 with 11, 24 with 14, 22 with 12).

<sup>(1)</sup> With the relay 41.81 the NO change-over contact will be 11-14.

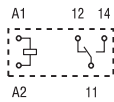

41.31

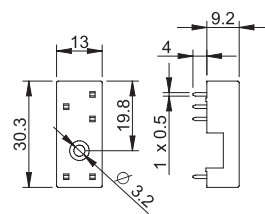

95.13.2  
Copper side view

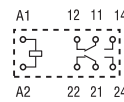

41.52

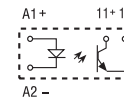

41.81 - 9024

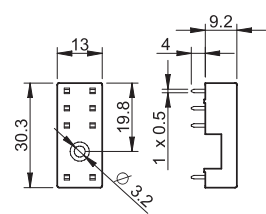

95.15.2  
Copper side view

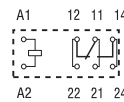

41.61

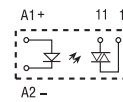

41.81 - 8240

Note: Not for bistable relays

## Packaging codes

How to code and identify retaining clip and packaging options for sockets.

Example:

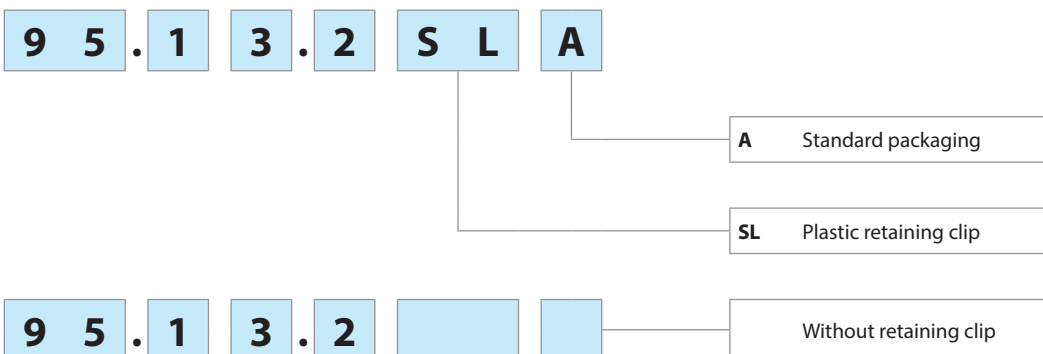

# Low profile PCB relays 10 - 16 A



Medical and  
dentistry



Alarm systems



Air conditioners



Burners,  
boilers and  
furnaces



Electric and  
electronic toys  
and games



Door and  
gate openers

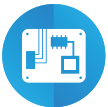

Electronic circuit  
boards



Vending  
machines

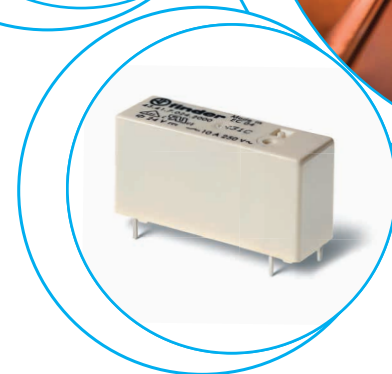
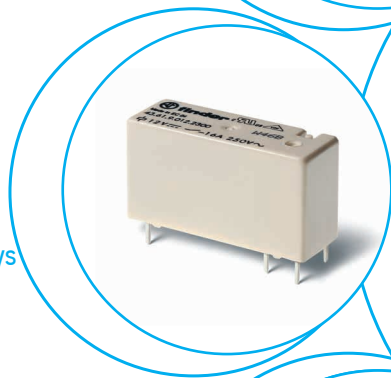





**1 Pole - Low profile (15.4 mm height)**

**Type 43.41**

- 1 Pole, 10 A (3.2 mm pin pitch)

**Type 43.41-0300**

- 1 Pole NO, 10 A (5 mm pin pitch)

**Type 43.61-0300**

- 1 Pole NO, 16 A (5 mm pin pitch)

**PCB mount - direct or via PCB socket (43.41 version)**

- Sensitive DC coil:
  - 250 mW (10 A version)
  - 400 mW (16 A version)
- Very high coil-contact isolation 10 mm, 6 kV (1.2/50 μs)
- Cadmium Free contacts (preferred version)
- Flux proof: RT II standard, (RT III option)

FOR UL RATINGS SEE:

"General technical information" page V

For outline drawing see page 5

**Contact specification**

Contact configuration		1 CO (SPDT)	1 NO (SPST-NO)	1 NO (SPST-NO)
Rated current/Maximum peak current	A	10/15	10/15	16/25
Rated voltage/Maximum switching voltage	V AC	250/400	250/400	250/400
Rated load AC1	VA	2500	2500	4000
Rated load AC15 (230 V AC)	VA	500	500	750
Single phase motor rating (230 V AC)	kW	—	—	—
Breaking capacity DC1: 24/110/220 V	A	10/0.3/0.12	10/0.3/0.12	16/0.3/0.12
Minimum switching load	mW (V/mA)	300 (5/5)	300 (5/5)	300 (5/5)
Standard contact material		AgNi	AgNi	AgNi

**Coil specification**

Nominal voltage (U <sub>N</sub> )	V AC (50/60 Hz)	—	—	—
	V DC	3 - 6 - 9 - 12 - 18 - 24 - 36 - 48	3 - 6 - 9 - 12 - 18 - 24 - 36 - 48	12 - 24 - 48
Rated power AC/DC	VA (50 Hz)/W	—/0.25	—/0.25	—/0.4
Operating range	AC	—	—	—
	DC	(0.7...1.5)U <sub>N</sub>	(0.7...1.5)U <sub>N</sub>	(0.7...1.2)U <sub>N</sub>
Holding voltage	AC/DC	—/0.4 U <sub>N</sub>	—/0.4 U <sub>N</sub>	—/0.4 U <sub>N</sub>
Must drop-out voltage	AC/DC	—/0.05 U <sub>N</sub>	—/0.05 U <sub>N</sub>	—/0.05 U <sub>N</sub>

**Technical data**

Mechanical life AC/DC	cycles	—/10 · 10 <sup>6</sup>	—/10 · 10 <sup>6</sup>	—/10 · 10 <sup>6</sup>
Electrical life at rated load AC1	cycles	100 · 10 <sup>3</sup>	100 · 10 <sup>3</sup>	50 · 10 <sup>3</sup>
Operate/release time	ms	6/4	6/2	6/2
Insulation between coil and contacts (1.2/50 μs)	kV	6 (10 mm)	6 (10 mm)	6 (10 mm)
Dielectric strength between open contacts	V AC	1000	1000	1000
Ambient temperature range	°C	-40...+85	-40...+85	-40...+85
Environmental protection		RT II	RT II	RT II

**Approvals (according to type)**

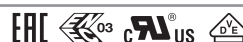

43.41	43.41-0300	43.61-0300		
<ul style="list-style-type: none"> <li>• 3.2 mm contact pin pitch</li> <li>• 1 Pole CO, 10 A</li> <li>• PCB direct or via socket</li> </ul>	<ul style="list-style-type: none"> <li>• 5.0 mm contact pin pitch</li> <li>• 1 Pole NO, 10 A</li> <li>• PCB mount</li> </ul>	<ul style="list-style-type: none"> <li>• 5.0 mm contact pin pitch</li> <li>• 1 Pole NO, 16 A</li> <li>• PCB mount</li> </ul>		
Copper side view	Copper side view	Copper side view		
<b>Contact specification</b>				
Contact configuration	1 CO (SPDT)	1 NO (SPST-NO)	1 NO (SPST-NO)	
Rated current/Maximum peak current	A	10/15	10/15	16/25
Rated voltage/Maximum switching voltage	V AC	250/400	250/400	250/400
Rated load AC1	VA	2500	2500	4000
Rated load AC15 (230 V AC)	VA	500	500	750
Single phase motor rating (230 V AC)	kW	—	—	—
Breaking capacity DC1: 24/110/220 V	A	10/0.3/0.12	10/0.3/0.12	16/0.3/0.12
Minimum switching load	mW (V/mA)	300 (5/5)	300 (5/5)	300 (5/5)
Standard contact material		AgNi	AgNi	AgNi
<b>Coil specification</b>				
Nominal voltage (U <sub>N</sub> )	V AC (50/60 Hz)	—	—	—
	V DC	3 - 6 - 9 - 12 - 18 - 24 - 36 - 48	3 - 6 - 9 - 12 - 18 - 24 - 36 - 48	12 - 24 - 48
Rated power AC/DC	VA (50 Hz)/W	—/0.25	—/0.25	—/0.4
Operating range	AC	—	—	—
	DC	(0.7...1.5)U <sub>N</sub>	(0.7...1.5)U <sub>N</sub>	(0.7...1.2)U <sub>N</sub>
Holding voltage	AC/DC	—/0.4 U <sub>N</sub>	—/0.4 U <sub>N</sub>	—/0.4 U <sub>N</sub>
Must drop-out voltage	AC/DC	—/0.05 U <sub>N</sub>	—/0.05 U <sub>N</sub>	—/0.05 U <sub>N</sub>
<b>Technical data</b>				
Mechanical life AC/DC	cycles	—/10 · 10 <sup>6</sup>	—/10 · 10 <sup>6</sup>	—/10 · 10 <sup>6</sup>
Electrical life at rated load AC1	cycles	100 · 10 <sup>3</sup>	100 · 10 <sup>3</sup>	50 · 10 <sup>3</sup>
Operate/release time	ms	6/4	6/2	6/2
Insulation between coil and contacts (1.2/50 μs)	kV	6 (10 mm)	6 (10 mm)	6 (10 mm)
Dielectric strength between open contacts	V AC	1000	1000	1000
Ambient temperature range	°C	-40...+85	-40...+85	-40...+85
Environmental protection		RT II	RT II	RT II
<b>Approvals (according to type)</b>				

## Ordering information

Example: 43 series low-profile PCB relay, 1 CO (SPDT), 24 V DC coil.

A

**4 3 . 4 1 . 7 . 0 2 4 . 2 0 0 0**

**Series**

**Type**

- 4 = PCB - 3.2 mm pinning (CO/SPDT, 10 A)
- PCB - 5 mm pinning (NO/SPST-NO, 10 A)
- 6 = PCB - 5 mm pinning (NO/SPST-NO, 16 A)

**No. of poles**

1 = 1 pole

**Coil version**

- 7 = Sensitive DC (only for 43.41)
- 9 = DC (only for 43.61)

**Coil voltage**

See coil specifications

**A: Contact material**

- 0 = AgNi
- 2 = AgCdO
- 4 = AgSnO<sub>2</sub>
- 5 = AgNi + Au

**B: Contact circuit**

- 0 = CO (SPDT) - (for 43.41 only)
- 3 = NO (SPST)

**D: Special versions**

- 0 = Flux proof (RT II)
- 1 = Wash tight (RT III)

**C: Options**

- 0 = None

**Selecting features and options: only combinations in the same row are possible.**  
Preferred selections for best availability are shown in **bold**.

Type	Coil version	A	B	C	D
43.41	sensitive DC	<b>0</b> - 2 - 4 - 5	<b>0</b> - 3	<b>0</b>	<b>0</b> - 1
43.61	DC	<b>0</b> - 2 - 4	<b>3</b>	<b>0</b>	<b>0</b>

## Technical data

### Insulation according to EN 61810-1

Nominal voltage of supply system	V AC	230/400
Rated insulation voltage	V AC	250 400
Pollution degree		3 2

### Insulation between coil and contact set

Type of insulation	Reinforced (10 mm)
Overvoltage category	III
Rated impulse voltage	kV (1.2/50 μs) 6
Dielectric strength	V AC 4000

### Insulation between open contacts

Type of disconnection	Micro-disconnection
Dielectric strength	V AC/kV (1.2/50 μs) 1000/1.5

### Insulation between coil terminals

Rated impulse voltage (surge) differential mode (according to EN 61000-4-5)	kV (1.2/50 μs) 2
---	------------------

### Other data

Bounce time: NO/NC	ms	3/6
Vibration resistance (5...55)Hz: NO/NC	g	15/3
Shock resistance	g	15
Power lost to the environment	without contact current	W 0.25 (43.41) 0.4 (43.61)
	with rated current	W 1.3 (43.41) 2 (43.61)
Recommended distance between relays mounted on PCB	mm	≥ 5

## Contact specification

F 43 - Electrical life (AC) v contact current

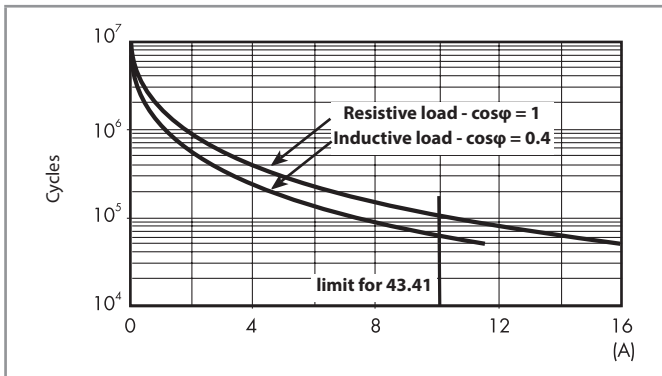

H 43 - Maximum DC1 breaking capacity

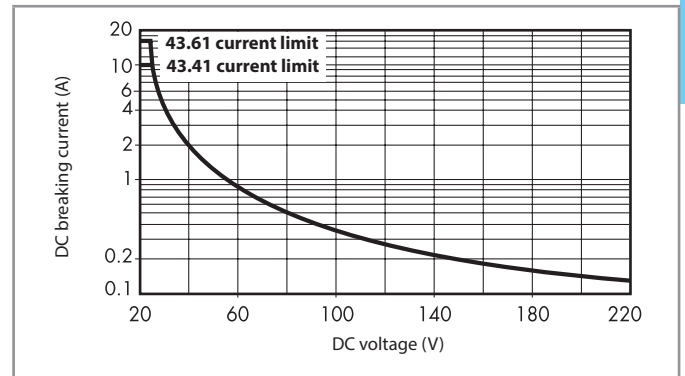

- When switching a resistive load (DC1) having voltage and current values under the curve, an electrical life of  $\geq 100 \cdot 10^3$  for 43.41 and  $\geq 50 \cdot 10^3$  for 43.61 can be expected.
- In the case of DC13 loads, the connection of a diode in parallel with the load will permit a similar electrical life as for a DC1 load.  
Note: the release time for the load will be increased.

## Coil specifications

DC coil data - 0.25 W sensitive (type 43.41)

Nominal voltage $U_N$ V	Coil code	Operating range		Resistance R $\Omega$	Rated coil consumption I at $U_N$ mA
		$U_{min}$ V	$U_{max}$ V		
3	7.003	2.2	4.5	36	83.5
6	7.006	4.2	9	150	40
9	7.009	6.5	13.5	324	27.7
12	7.012	8.4	18	580	20.7
18	7.018	13	27	1300	13.8
24	7.024	16.8	36	2200	10.9
36	7.036	25.2	54	5200	6.9
48	7.048	33.6	72	9200	5.2

R 43 - DC coil operating range v ambient temperature

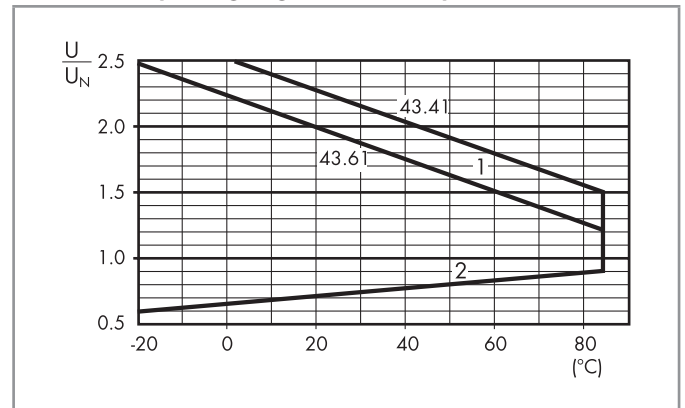

- 1 - Max. permitted coil voltage.
- 2 - Min. pick-up voltage with coil at ambient temperature.

DC coil data - 0.4 W standard (type 43.61)

Nominal voltage $U_N$ V	Coil code	Operating range		Resistance R $\Omega$	Rated coil consumption I at $U_N$ mA
		$U_{min}$ V	$U_{max}$ V		
12	9.012	8.4	14.4	360	33.3
24	9.024	16.8	28.8	1400	17.1
48	9.048	33.6	57.6	5760	8.3

## Outline drawings

Type 43.41

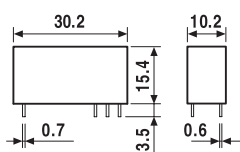

Types 43.41-0300/43.61-0300

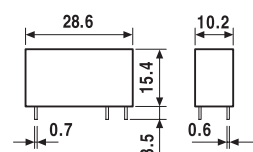



A

95.23

Approvals  
(according to type):



PCB socket (for changeover contacts only)	95.23 (blue)	95.23.0 (black)
For relay type	43.41	43.41
<b>Accessories</b>		
Metal retaining clip (supplied with socket - packaging code SNA)		095.43
<b>Technical data</b>		
Rated values	10 A - 250 V	
Insulation	6 kV (1.2/50 μs) between coil and contacts	
Protection category	IP 20	
Ambient temperature	°C -40...+70	

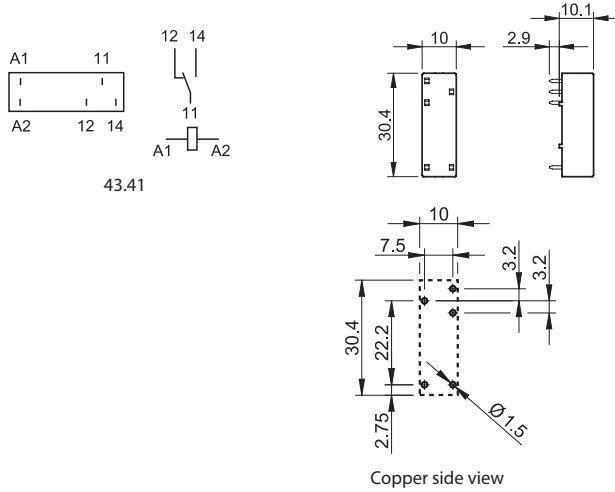

## Packaging codes

How to code and identify retaining clip and packaging options for sockets.

Example:

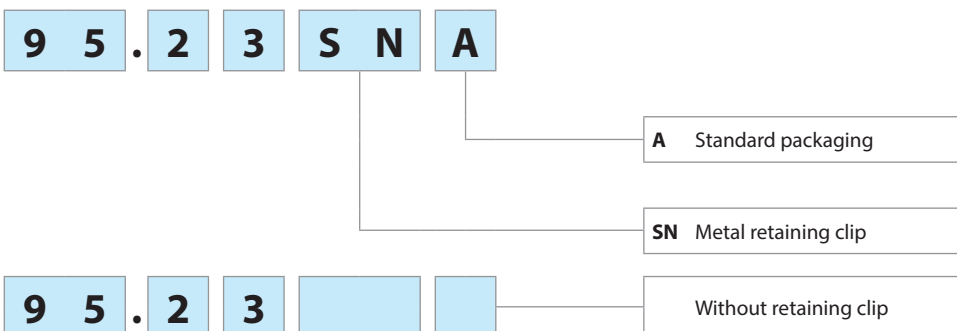

# Miniature PCB Relays + Faston 250 10 - 16 A



Burners, boilers and furnaces



Jacuzzis and hot tubs



Infrared and microwave ovens



Film projectors

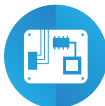

Electronic circuit boards



Control and management of electric power



Inverter



Charging Stations

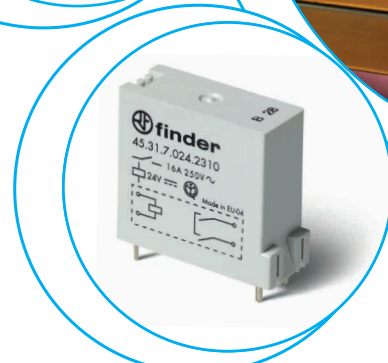
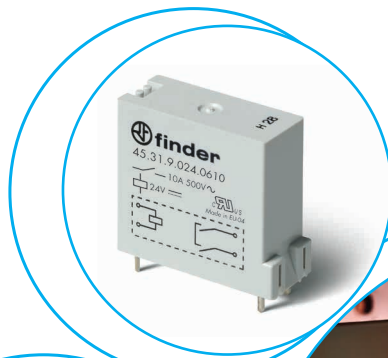



Relay for +105 °C ambient use  
PCB mount - high contact gap for photovoltaic  
inverters and charging station  
PCB mount

- 45.31...x310, 1 Pole normally open (≥ 3 mm contact gap)
- 45.31...4310, Conform to Annex CC EN 61439-7:2018 for ev charging station
- 45.31...0610, 1 Pole normally open (≥ 3.6 mm contact gap)
- Contact gap ≥ 3 mm or ≥ 3.6 mm according to EN 60730-1
- Sensitive DC coil - 360 mW (45.31...x310 type)
- Cadmium Free contact material
- Reinforced insulation between coil and contacts according to EN 60335-1, EN 50178, EN 60204 with safe separation and 8 mm clearance and creepage distance
- 6 kV (1.2/50 μs) isolation, coil-contacts
- Flux proof: RT II

FOR UL RATINGS SEE:  
"General technical information" page V

For outline drawing see page 7

**Contact specification**

Contact configuration	1NO (SPST-NO) ≥ 3 mm gap	1NO (SPST-NO) ≥ 3 mm gap	1NO (SPST-NO) ≥ 3.6 mm gap
Rated current/Maximum peak current (@105°C) A	16/30	16/80	10/30
Maximum switching current/Maximum peak current (@85°C) A	—	20/80	—
Rated voltage/Maximum switching voltage V AC	250/400	250/400	500/500
Rated load AC1 VA	4000	4000	5000
Peak current conform to Annex CC EN 61439-7:2018 A	—	230 (70 μs)	—
Peak current conform to IEC60669-2-1 A2:2015 A	—	120 (600 μs)	—
LED lamps rating (230 V) W	—	125	—
Rated load AC15 (230 V AC) VA	750	—	750
Single phase motor rating (230 V AC) kW	0.55	—	0.55
Breaking capacity DC1: 24/110/220 V A	16/4/1	16/4/1	10/4/1
Minimum switching load mW (V/mA)	500 (10/5)	500 (10/5)	500 (10/5)
Standard contact material	AgNi	AgSnO <sub>2</sub>	AgNi

**Coil specification**

Nominal voltage (U <sub>N</sub> )	V AC (50/60 Hz)	—	—	—
	V DC	6 - 12 - 24 - 48 - 60	6 - 12 - 24 - 48 - 60	6 - 12 - 24 - 48 - 60
Rated power AC/DC VA (50 Hz)/W	—/0.36	—/0.36	—/0.55	
Operating range	AC	—	—	—
	DC	(0.7...1.2)U <sub>N</sub>	(0.7...1.2)U <sub>N</sub>	(0.8...1.2)U <sub>N</sub>
Holding voltage AC/DC	—/0.4 U <sub>N</sub>	—/0.4 U <sub>N</sub>	—/0.4 U <sub>N</sub>	
Must drop-out voltage AC/DC	—/0.1 U <sub>N</sub>	—/0.1 U <sub>N</sub>	—/0.1 U <sub>N</sub>	

**Technical data**

Mechanical life AC/DC cycles	—/10 · 10 <sup>6</sup>	—/10 · 10 <sup>6</sup>	—/2 · 10 <sup>6</sup>
Electrical life at rated load AC1 cycles	30 · 10 <sup>3</sup>	20 · 10 <sup>3</sup>	10 · 10 <sup>3</sup>
Operate/release time ms	12/2	12/2	12/2
Insulation between coil and contacts (1.2/50 μs) kV	6 (8 mm)	6 (8 mm)	6 (8 mm)
Dielectric strength between open contacts V AC	2500	2500	3000
Ambient temperature range °C	-40...+105	-40...+105	-40...+105
Environmental protection	RT II	RT II	RT II

Approvals (according to type)

45.31...x310



- 1 NO (SPST-NO), ≥ 3 mm gap
- Max ambient temperature +105 °C
- PCB mounting

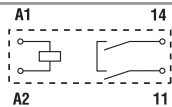

45.31...x310  
(1 NO/SPST-NO)

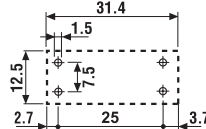

Copper side view

NEW 45.31...4310



- 1 NO (SPST-NO), ≥ 3 mm gap
- Conform to Annex CC EN 61439-7:2018 for ev charging station
- Max ambient temperature +105 °C
- PCB mounting

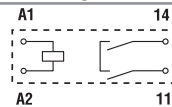

45.31...4310  
(1 NO)

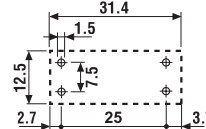

Copper side view

45.31...0610



- 1 NO (SPST-NO), ≥ 3.6 mm gap
- Max ambient temperature +105 °C
- PCB mounting

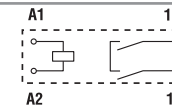

45.31...0610  
(1 NO/SPST-NO)

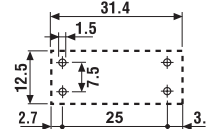

Copper side view

A

**Relays for +125 °C ambient use  
PCB mount - Faston 250 contact connections**

- 45.71, 1 Pole normally open or normally closed
- 45.91, 1 Pole normally open (≥ 3 mm contact gap)

- Contact gap ≥ 3 mm according to EN 60730-1 (45.91 type)
- Sensitive DC coil - 360 mW
- Cadmium Free option available
- Reinforced insulation between coil and contacts according to EN 60335-1, EN 50178, EN 60204 with safe separation and 8 mm clearance and creepage distance
- 6 kV (1.2/50 μs) isolation, coil-contacts
- Flux proof: RT II standard, (RT III option)

FOR UL RATINGS SEE:  
"General technical information" page V

For outline drawing see page 7

**Contact specification**

Contact configuration		1NO or 1NC (SPST-NO or SPST-NC)	1NO (SPST-NO) ≥ 3 mm gap
Rated current/Maximum peak current	A	16/30	16/30
Rated voltage/ Maximum switching voltage	V AC	250/400	250/400
Rated load AC1	VA	4000	4000
Rated load AC15 (230 V AC)	VA	750	750
Single phase motor rating (230 V AC)	kW	0.55	0.55
Breaking capacity DC1: 24/110/220 V	A	16/0.3/0.13	16/4/1
Minimum switching load	mW (V/mA)	500 (10/5)	500 (10/5)
Standard contact material		AgCdO	AgNi

**Coil specification**

Nominal voltage (U <sub>N</sub> )	V AC (50/60 Hz)	—	—
	V DC	6 - 12 - 24 - 48 - 60	6 - 12 - 24 - 48 - 60
Rated power AC/DC	VA (50 Hz)/W	—/0.36	—/0.36
Operating range	AC	—	—
	DC	(0.7...1.2)U <sub>N</sub>	(0.7...1.2)U <sub>N</sub>
Holding voltage	AC/DC	—/0.4 U <sub>N</sub>	—/0.4 U <sub>N</sub>
Must drop-out voltage	AC/DC	—/0.1 U <sub>N</sub>	—/0.1 U <sub>N</sub>

**Technical data**

Mechanical life AC/DC	cycles	—/10 · 10 <sup>6</sup>	—/10 · 10 <sup>6</sup>
Electrical life at rated load AC1	cycles	100 · 10 <sup>3</sup>	30 · 10 <sup>3</sup>
Operate/release time	ms	10/2	12/2
Insulation between coil and contacts (1.2/50 μs)	kV	6 (8 mm)	6 (8 mm)
Dielectric strength between open contacts	V AC	1000	2500
Ambient temperature range	°C	-40...+125	-40...+125
Environmental protection		RT II	RT II

**Approvals** (according to type)

**45.71**



- 1 NO or 1 NC (SPST-NO or SPST-NC)
- Max ambient temperature +125 °C
- PCB mounting + Faston 250

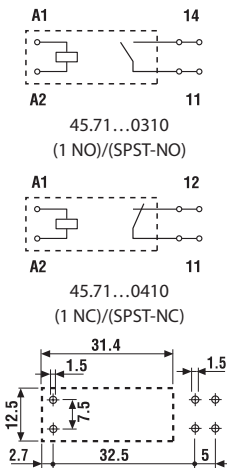

**45.91**



- 1 NO (SPST-NO), ≥ 3 mm gap
- Max ambient temperature +125 °C
- PCB mounting + Faston 250

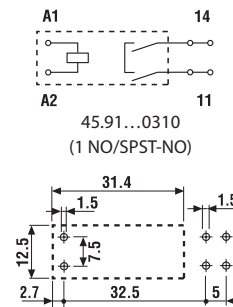



## Ordering information

Example: 45 series for PCB relay + Faston 250, 1 NO (SPST-NO), 12 V DC coil.

**4 5 . 7 1 . 7 . 0 1 2 . 0 3 1 0**

**Series** ————

**Type** ————

3 = PCB mount, ≥ 3 mm or ≥ 3.6 mm contact gap  
7 = PCB + Faston 250 mount  
9 = PCB + Faston 250 mount, ≥ 3 mm

**No. of poles** ————

1 = 1 pole, 16 A

**Coil version** ————

7 = Sensitive DC  
9 = Standard DC (45.31...0610 only)

**Coil voltage** ————

See coil specifications

**A: Contact material**  
0 = Standard AgCdO for 45.71, Standard AgNi for 45.31 and 45.91  
1 = AgNi  
2 = AgCdO  
4 = AgSnO<sub>2</sub> for 45.31

**B: Contact circuit**  
3 = NO (SPST)  
4 = NC (SPST) 45.71 only  
6 = NO (SPST), ≥ 3.6 mm

**C: Options**  
1 = None

**D: Special versions**  
0 = Flux proof (RT II)  
1 = Wash tight (RT III) 45.71 and 45.91 only

Selecting features and options: only combinations in the same row are possible.

Type	Coil version	A	B	C	D
45.31	sensitive DC	0 - 2 - 4	3	1	0
	standard DC	0	6	1	0
45.71	sensitive DC	0 - 1	3 - 4	1	0 - 1
45.91	sensitive DC	0 - 2	3	1	0 - 1

## Technical data

Insulation according to EN 61810-1		45.71		45.31 / 45.91	
Nominal voltage of supply system	V AC	230/400		230/400	
Rated insulation voltage	V AC	250	400	250	400
Pollution degree		3	2	3	2
<b>Insulation between coil and contact set</b>					
Type of insulation		Reinforced (8 mm)		Reinforced (8 mm)	
Overvoltage category		III		III	
Rated impulse voltage	kV (1.2/50 μs)	6		6	
Dielectric strength	V AC	4000		4000	
<b>Insulation between open contacts</b>					
Type of disconnection		Micro-disconnection		Full-disconnection	
Overvoltage category		—		III	
Rated impulse voltage	kV (1.2/50 μs)	—		4	
Dielectric strength	V AC/kV (1.2/50 μs)	1000/1.5		2500/4	
<b>Insulation between coil terminals</b>					
Rated impulse voltage (surge) differential mode (according to EN 61000-4-5)	kV (1.2/50 μs)	2			
<b>Other data</b>		45.71		45.31 / 45.91	
Bounce time: NO/NC	ms	3/3		2/—	
Vibration resistance (10...150)Hz: NO/NC	g	20/10		20/—	
Shock resistance	g	20			
Power lost to the environment	without contact current	W	0.4		
	with rated current	W	1.8		
Recommended distance between relays mounted on PCB	mm	≥ 5			

## Contact specification

### F 45 - Electrical life (AC) v contact current

Type 45.71

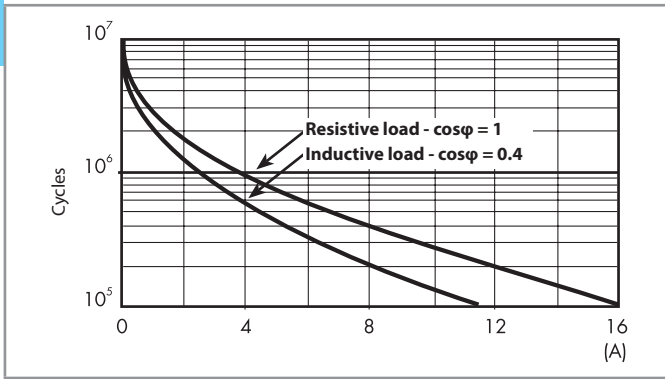

### F 45 - Electrical life (AC) v contact current

Type 45.31/45.91

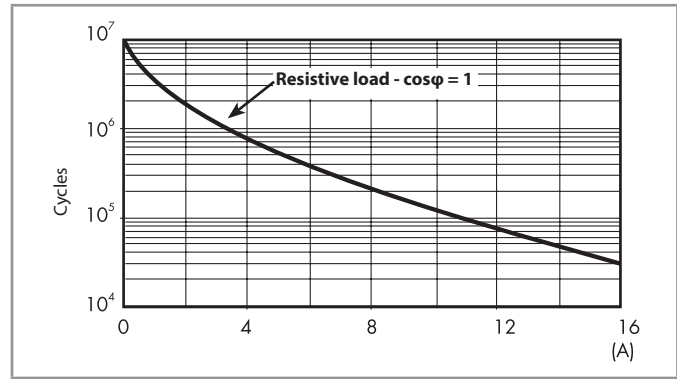

### F 45 - Electrical life (AC) v contact current

Type 45.31...4310

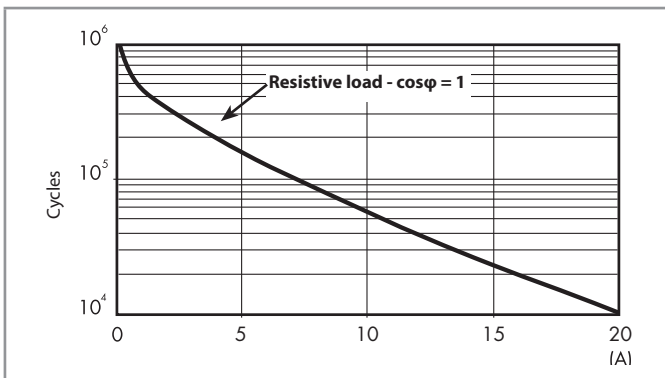

### H 45 - Maximum DC1 breaking capacity

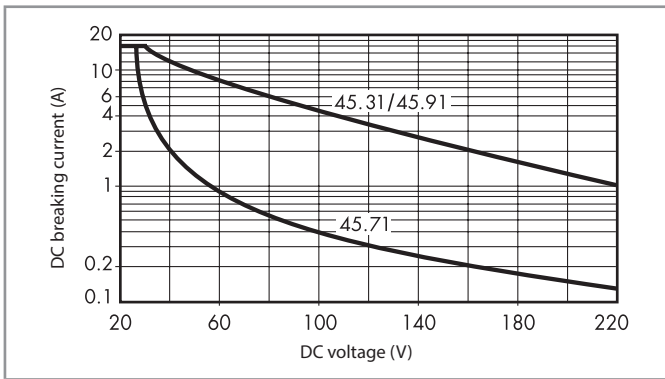

- When switching a resistive load (DC1) having voltage and current values under the curve, an electrical life of  $\geq 100 \cdot 10^3$  cycles (45.71) and  $\geq 30 \cdot 10^3$  cycles (45.31, 45.91) can be expected.
- In the case of DC13 loads, the connection of a diode in parallel with the load will permit a similar electrical life as for a DC1 load.  
Note: the release time for the load will be increased.

## Coil specifications

DC coil data - 0.36 W sensitive

Nominal voltage $U_N$	Coil code	Operating range		Resistance R	Rated coil consumption I at $U_N$
		$U_{min}$	$U_{max}$		
V		V	V	$\Omega$	mA
6	7.006	4.2	7.2	100	60
12	7.012	8.4	14.4	400	30
24	7.024	16.8	28.8	1600	15
48	7.048	33.6	57.6	6400	7.5
60	7.060	42	72	10000	6

DC coil data - 0.55 W standard

Nominal voltage $U_N$	Coil code	Operating range		Resistance R	Rated coil consumption I at $U_N$
		$U_{min}$	$U_{max}$		
V		V	V	$\Omega$	mA
6	9.006	4.2	7.2	72	83
12	9.012	8.4	14.4	300	40
24	9.024	16.8	28.8	1150	21
48	9.048	33.6	57.6	4400	11
60	9.060	42	72	7200	8.3

R 45 - DC coil operating range v ambient temperature

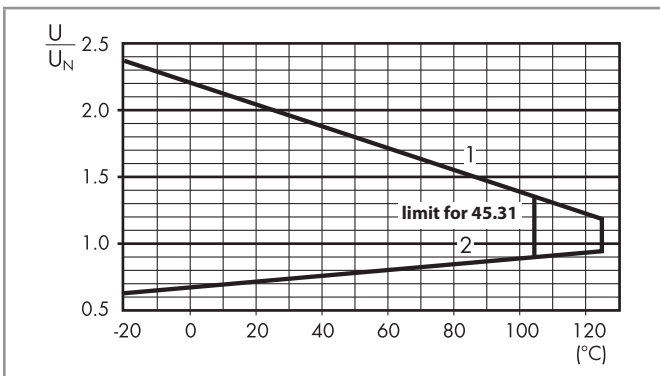

- 1 - Max. permitted coil voltage.
- 2 - Min. pick-up voltage with coil at ambient temperature.

## Outline drawings

Type 45.31

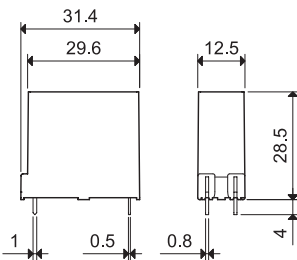

Types 45.71/91

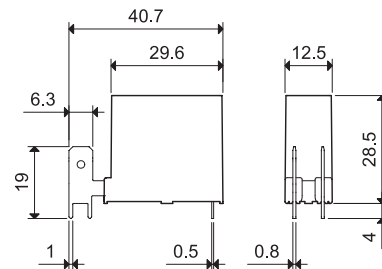



# Miniature Industrial relay 8 - 16 A



Automation for blinds, grilles and shutters



Elevators and lifts



Shipyards



Road / tunnel lighting



Hoists and cranes



Bottling plant



Control panels



Panels for electrical distribution

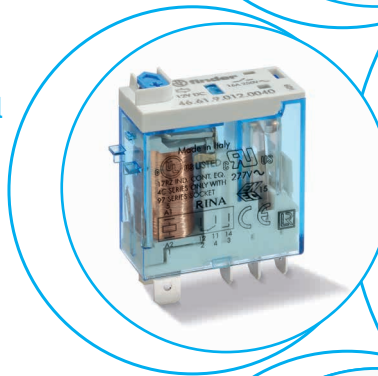
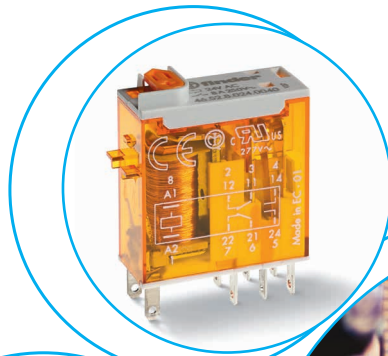



**1 & 2 CO industrial style power relays**  
**For socket mount or direct connection via**  
**Faston connectors**

**Type 46.52**

- 2 CO 8 A

**Type 46.61**

- 1 CO 16 A

- AC coils & DC coils
- Available with: lockable test button, mechanical indicator & LED indicator
- 8 mm, 6 kV (1.2/50 µs) isolation, coil-contacts
- Cadmium free contacts
- 97 series 35 mm rail (EN 60715) Screw, Screwless or Push-in terminals, and PCB mount sockets
- Coil Indication and EMC suppression modules 99 series and Timer module 86.30 options
- Optional alternative mounting adaptors
- European Patent

46.52



- 2 CO 8 A
- Plug-in/Solder terminals

46.61



- 1 CO 16 A
- Plug-in/Faston 187

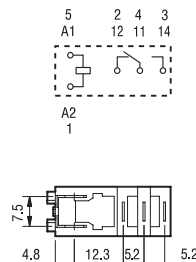
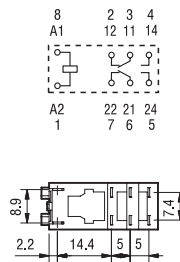

FOR UL RATINGS SEE:  
"General technical information" page V

For outline drawing see page 6

**Contact specification**

Contact configuration		2 CO (DPDT)	1 CO (SPDT)
Rated current/Maximum peak current	A	8/15	16/25*
Rated voltage/Maximum switching voltage	V AC	250/440	250/440
Rated load AC1	VA	2000	4000
Rated load AC15 (230 V AC)	VA	350	750
Single phase motor rating (230 V AC)	kW	0.37	0.55
Breaking capacity DC1: 24/110/220 V	A	6/0.5/0.15	12/0.5/0.15
Minimum switching load	mW (V/mA)	300 (5/5)	300 (5/5)
Standard contact material		AgNi	AgNi

\* With the AgSnO<sub>2</sub> material the maximum peak current is 80 A - 5 ms on normally open contact.

**Coil specification**

Nominal voltage (U <sub>N</sub> )	V AC (50/60 Hz)	12 - 24 - 48 - 110 - 120 - 230 - 240
	V DC	12 - 24 - 48 - 110 - 125
Rated power	VA/W	1.2/0.5
Operating range	AC	(0.8...1.1)U <sub>N</sub>
	DC	(0.73...1.1)U <sub>N</sub>
Holding voltage	AC/DC	0.8 U <sub>N</sub> / 0.4 U <sub>N</sub>
Must drop-out voltage	AC/DC	0.2 U <sub>N</sub> / 0.1 U <sub>N</sub>

**Technical data**

Mechanical life AC/DC	cycles	10 · 10 <sup>6</sup>	10 · 10 <sup>6</sup>
Electrical life at rated load AC1	cycles	100 · 10 <sup>3</sup>	100 · 10 <sup>3</sup>
Operate/release time	ms	10/3	15/5
Insulation between coil and contacts (1.2/50 µs)	kV	6 (8 mm)	6 (8 mm)
Dielectric strength between open contacts	V AC	1000	1000
Ambient temperature range	°C	-40...+70	-40...+70
Environmental protection		RT II	RT II

**Approvals** (according to type)

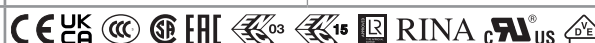

## Ordering information

Example: 46 series Miniature industrial relay, 1 CO, 24 V DC coil, lockable test button and mechanical indicator.

A

**4 6 . 6 1 . 9 . 0 2 4 . 0 0 4 0**

**Series** ————

**Type** ————  
5 = Spade/blade solder terminal (2.5 x 0.5)mm  
6 = Spade/blade terminal Faston 187 (4.8 x 0.5)mm

**No. of poles** ————  
1 = 1 pole, 16 A  
2 = 2 poles, 8 A

**Coil version** ————  
9 = DC  
8 = AC (50/60 Hz)

**Coil voltage** ————  
See coil specifications

**A: Contact material**  
0 = AgNi  
4 = AgSnO<sub>2</sub> (46.61 only)  
5 = AgNi + Au

**B: Contact circuit**  
0 = CO (nPDT)

**D: Special versions**  
0 = Standard

**C: Options**  
2 = Mechanical indicator  
4 = Lockable test button + mechanical indicator  
54 = Lockable test button + LED (AC) + mechanical indicator  
74 = Lockable test button + double LED (DC non-polarized) + mechanical indicator

**Selecting features and options: only combinations in the same row are possible.**  
Preferred selections for best availability are shown in **bold**.

Type	Coil version	A	B	C	D
46.52	AC - DC	<b>0 - 5</b>	<b>0</b>	<b>2 - 4</b>	<b>0</b>
	AC	0 - 5	0	54	/
	DC	0 - 5	0	74	/
46.61	AC - DC	<b>0 - 4 - 5</b>	<b>0</b>	<b>2 - 4</b>	<b>0</b>
	AC	0 - 4 - 5	0	54	/
	DC	0 - 4 - 5	0	74	/

**Special versions for Rail Applications on request**

## Descriptions: Options

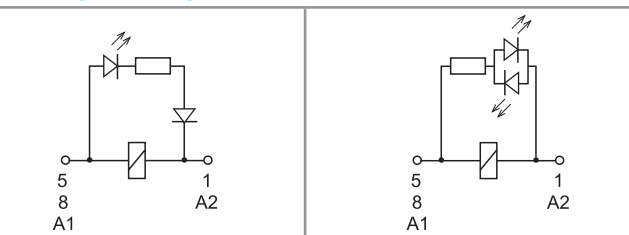

**C: Option 54**  
LED (AC)

**C: Option 74**  
LED (DC, non-polarized)

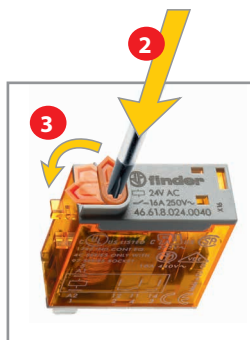

### Lockable test button and mechanical flag indicator (0040, 0054, 0074)

The dual-purpose Finder test button can be used in two ways:

**Case 1)** The plastic pip (located directly below the test button) remains intact. In this case, when the test button is pushed, the contacts operate. When the test button is released the contacts return to their former state.

**Case 2)** The plastic pip is broken-off (using an appropriate cutting tool). In this case, (in addition to the above function), when the test button is pushed and rotated, the contacts are latched in the operating state, and remain so until the test button is rotated back to its former position.

In both cases ensure that the test button actuation is swift and decisive.





## Technical data

Insulation according to EN 61810-1		1 pole		2 pole	
Nominal voltage of supply system	V AC	230/400		230/400	
Rated insulation voltage	V AC	250	400	250	400
Pollution degree		3	2	3	2
<b>Insulation between coil and contact set</b>					
Type of Insulation		Reinforced (8 mm)		Reinforced (8 mm)	
Overtoltage category		III		III	
Rated impulse voltage	kV (1.2/50 $\mu$ s)	6		6	
Dielectric strength	V AC	4000		4000	
<b>Insulation between adjacent contacts</b>					
Type of insulation		—		Basic	
Overtoltage category		—		III	
Rated impulse voltage	kV (1.2/50 $\mu$ s)	—		4	
Dielectric strength	V AC	—		2000	
<b>Insulation between open contacts</b>					
Type of disconnection		Micro-disconnection		Micro-disconnection	
Dielectric strength	V AC/kV (1.2/50 $\mu$ s)	1000/1.5		1000/1.5	
<b>Insulation between coil terminals</b>					
Rated impulse voltage (surge) differential mode (according to EN 61000-4-5)	kV (1.2/50 $\mu$ s)	2			
<b>Other data</b>		<b>46.61</b>		<b>46.52</b>	
Bounce time: NO/NC	ms	2/6		1/4	
Vibration resistance (10...150)Hz: NO/NC	g	20/12		20/15	
Shock resistance	g	20		20	
Power lost to the environment	without contact current	W	0.6	0.6	
	with rated current	W	1.6	2	
Recommended distance between relays mounted on PCB	mm	$\geq 5$			

## Contact specification

### F 46 - Electrical life (AC) v contact current

Type 46.52

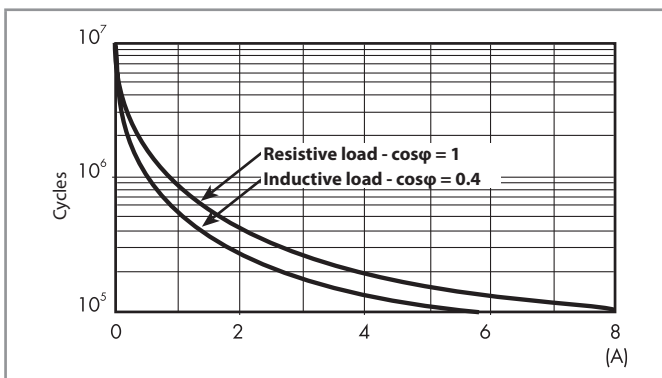

### F 46 - Electrical life (AC) v contact current

Type 46.61

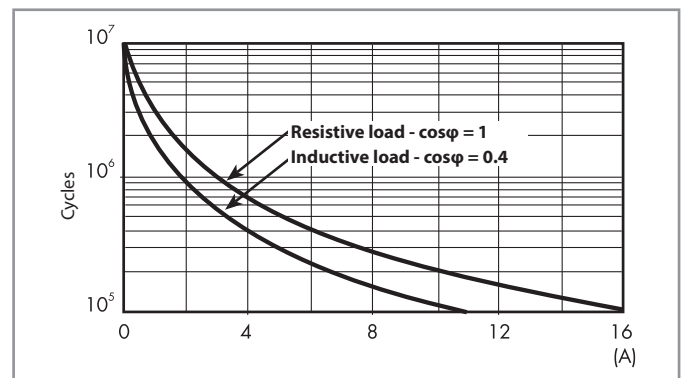

### H 46 - Maximum DC1 breaking capacity

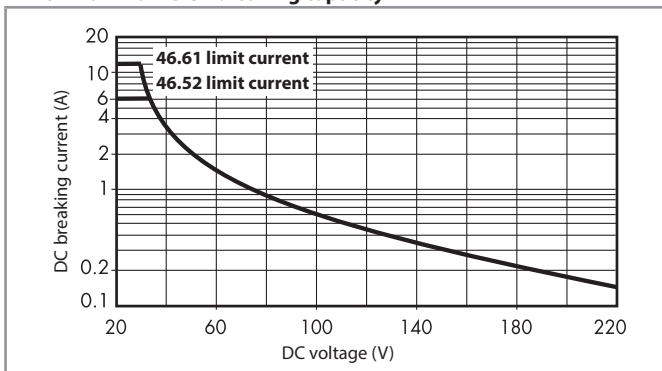

- When switching a resistive load (DC1) having voltage and current values under the curve, an electrical life of  $\geq 100 \cdot 10^3$  can be expected.
  - In the case of DC13 loads, the connection of a diode in parallel with the load will permit a similar electrical life as for a DC1 load.
- Note: the release time for the load will be increased.

## Coil specifications

### DC coil data

Nominal voltage $U_N$ V	Coil code	Operating range		Resistance R $\Omega$	Rated coil consumption I at $U_N$ mA
		$U_{min}$ V	$U_{max}$ V		
12	9.012	8.8	13.2	300	40
24	9.024	17.5	26.4	1200	20
48	9.048	35	52.8	4800	10
110	9.110	80	121	23500	4.7
125	9.125	91.2	138	32000	3.9

### AC coil data

Nominal voltage $U_N$ V	Coil code	Operating range		Resistance R $\Omega$	Rated coil consumption I at $U_N$ mA
		$U_{min}$ V	$U_{max}$ V		
12	8.012	9.6	13.2	80	90
24	8.024	19.2	26.4	320	45
48	8.048	38.4	52.8	1350	21
110	8.110	88	121	6900	9.4
120	8.120	96	132	9000	8.4
230	8.230	184	253	28000	5
240	8.240	192	264	31500	4.1

R 46 - DC coil operating range v ambient temperature

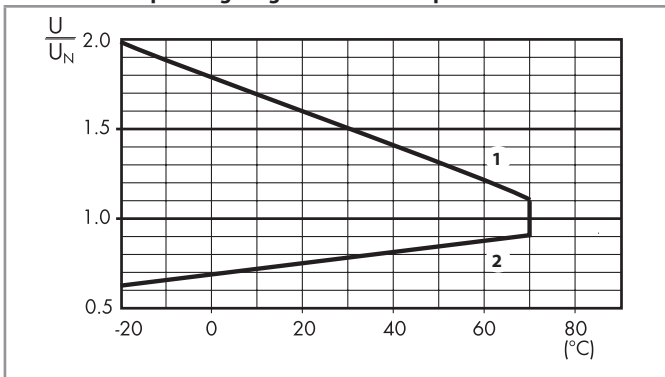

- 1 - Max. permitted coil voltage.  
2 - Min. pick-up voltage with coil at ambient temperature.

R 46 - AC coil operating range v ambient temperature

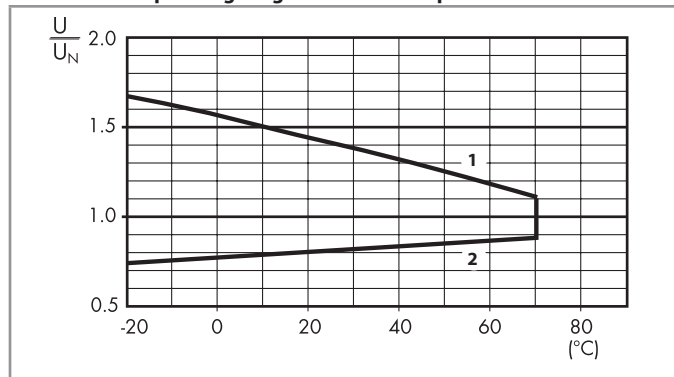

- 1 - Max. permitted coil voltage.  
2 - Min. pick-up voltage with coil at ambient temperature.

## Outline drawings

Type 46.52

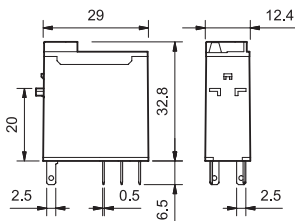

Type 46.61

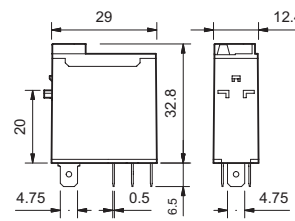

Accessories



046.05

Flange mount adaptor for relays types 46.52 and 46.61

046.05

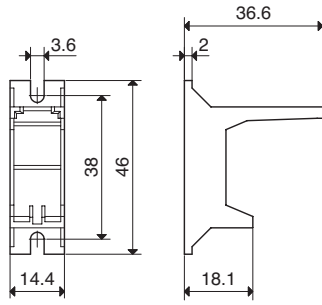

046.05

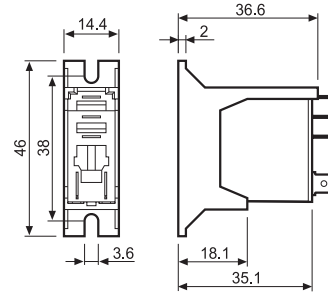

046.05 with relay

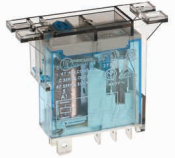

046.05 with relay



046.07

35 mm rail adaptor for relays types 46.52 and 46.61

046.07

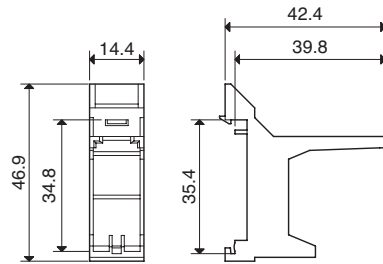

046.07

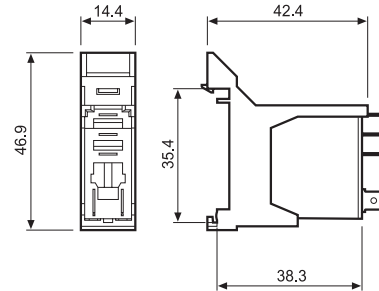

046.07 with relay

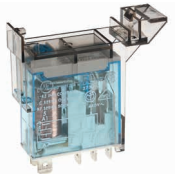

046.07 with relay

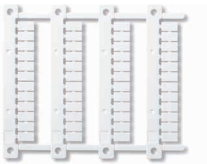

060.48

Sheet of marker tags (CEMBRE Thermal transfer printers) for relays types 46.52 and 46.61, (48 tags) 6 x 12 mm

060.48

A

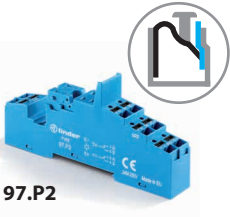

97.P2

Approvals  
(according to type):



097.01

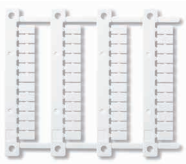

060.48

<b>Push-in terminal socket</b> panel or 35 mm rail (EN 60715) mount	<b>97.P1</b>	<b>97.P2</b>
For relay type	46.61	46.52
<b>Accessories</b>		
Plastic retaining and release clip (supplied with socket - packaging code SPA)		097.01
Metal retaining clip		097.71
Identification tag		095.00.4
8-way jumper link		097.58
2-way jumper link		097.52
2-way jumper link		097.42
Marker tag holder		097.00
Modules (see table below)		99.02
Timer modules (see table below)		86.30
Sheet of marker tags for marker tag holder 097.00, 48 tags, 6 x 12 mm, for CEMBRE thermal transfer printers		060.48
<b>Technical data</b>		
Rated values	10 A-250 V AC	8 A-250 V AC
Dielectric strength	6 kV (1.2/50 μs) between coil and contacts	
Protection category	IP 20	
Ambient temperature	°C -40...+70	
Wire strip length	mm 10	
Min. wire size for 97.P1 and 97.P2 socket	solid wire	stranded wire
	mm <sup>2</sup> 0.5	0.5
	AWG 21	21
Max. wire size for 97.P1 and 97.P2 socket	solid wire	stranded wire
	mm <sup>2</sup> 2 x 1.5 / 1 x 2.5	2 x 1.5 / 1 x 2.5
	AWG 2 x 16 / 1 x 14	2 x 16 / 1 x 14

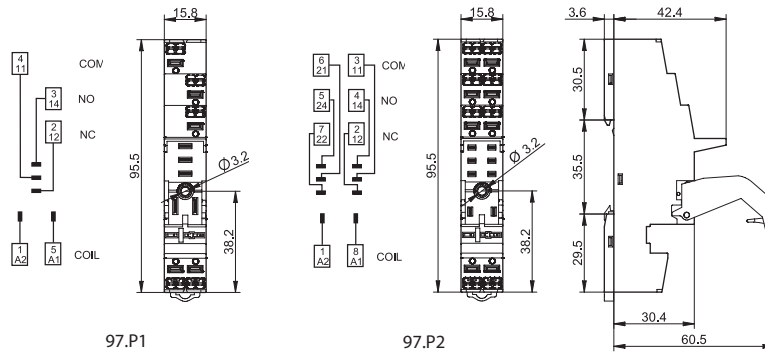

097.58

<b>8-way jumper link</b> for 97.P1 and 97.P2 sockets	<b>097.58</b>
Rated values	10 A - 250 V

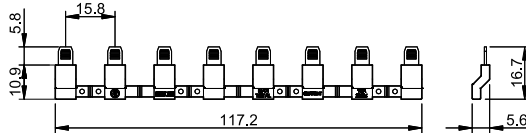

097.52

<b>2-way jumper link</b> for 97.P1 and 97.P2 sockets	<b>097.52</b>
Rated values	10 A - 250 V

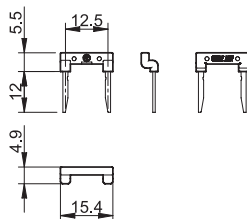



097.42

<b>2-way jumper link</b> for 97.P1 and 97.P2 sockets	097.42
Rated values	10 A - 250 V

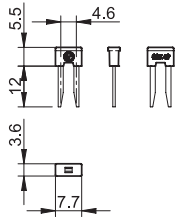

097.00

<b>Marker tag holder</b> for 97.P1 and 97.P2 sockets	097.00
--	--------

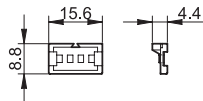

86.30

<b>86 series timer modules</b>	
(12...24)V AC/DC; Bi-function: AI, DI; (0.05 s...100 h)	86.30.0.024.0000
(110...125)V AC; Bi-function: AI, DI; (0.05 s...100 h)	86.30.8.120.0000
(230...240)V AC; Bi-function: AI, DI; (0.05 s...100 h)	86.30.8.240.0000

Approvals (according to type):



99.02

<b>99.02 coil indication and EMC suppression modules</b> for 97.P1 and 97.P2 sockets		
Diode (+A1, standard polarity)	(6...220)V DC	99.02.3.000.00
LED	(6...24)V DC/AC	99.02.0.024.59
LED	(28...60)V DC/AC	99.02.0.060.59
LED	(110...240)V DC/AC	99.02.0.230.59
LED + Diode (+A1, standard polarity)	(6...24)V DC	99.02.9.024.99
LED + Diode (+A1, standard polarity)	(28...60)V DC	99.02.9.060.99
LED + Diode (+A1, standard polarity)	(110...220)V DC	99.02.9.220.99
LED + Varistor	(6...24)V DC/AC	99.02.0.024.98
LED + Varistor	(28...60)V DC/AC	99.02.0.060.98
LED + Varistor	(110...240)V DC/AC	99.02.0.230.98
RC circuit	(6...24)V DC/AC	99.02.0.024.09
RC circuit	(28...60)V DC/AC	99.02.0.060.09
RC circuit	(110...240)V DC/AC	99.02.0.230.09
Residual current by-pass*	(110...240)V AC	99.02.8.230.07

\* Additional 0.9 W power dissipation

Approvals  
(according to type):



DC Modules with  
non-standard polarity  
(+A2) on request.

A

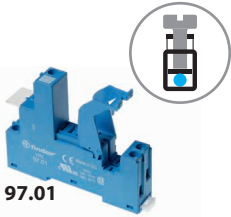

97.01

Approvals  
(according to type):



097.01

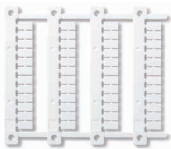

060.48

Screw terminal socket panel or 35 mm rail (EN 60715) mount	97.01 (blue)	97.01.0 (black)	97.02 (blue)	97.02.0 (black)
For relay type	46.61		46.52	
<b>Accessories</b>				
Plastic retaining and release clip (supplied with socket - packaging code SPA)			097.01	
Metal retaining clip			097.71	
Marker tag holder			097.00	
Identification tag			095.00.4	
8-way jumper link	095.18 (blue)		095.18.0 (black)	
Modules (see table below)			99.02	
Timer modules (see table below)			86.30	
Sheet of marker tags for marker tag holder 097.00, 48 tags, 6 x 12 mm, for CEMBRE thermal transfer printers			060.48	
<b>Technical data</b>				
Rated values	16 A-250 V AC		8 A-250 V AC	
Dielectric strength	6 kV (1.2/50 μs) between coil and contacts			
Protection category	IP 20			
Ambient temperature	°C -40...+70 (see diagram L97)			
Screw torque	Nm 0.8			
Wire strip length	mm 8			
Max. wire size for 97.01 and 97.02 socket	solid wire		stranded wire	
	mm <sup>2</sup> 1 x 6 / 2 x 2.5		1 x 4 / 2 x 2.5	
	AWG 1 x 10 / 2 x 14		1 x 12 / 2 x 14	

**L 97 - Rated current v ambient temperature**  
(for 46.61 relay/97.01 socket combination)

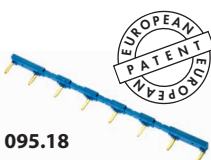
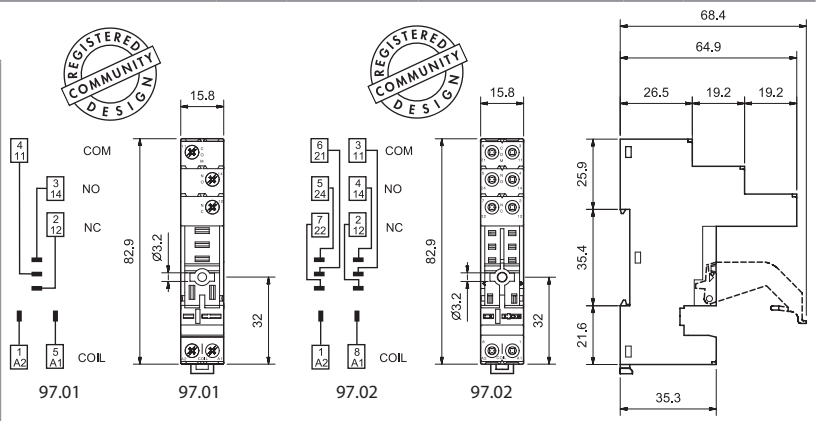
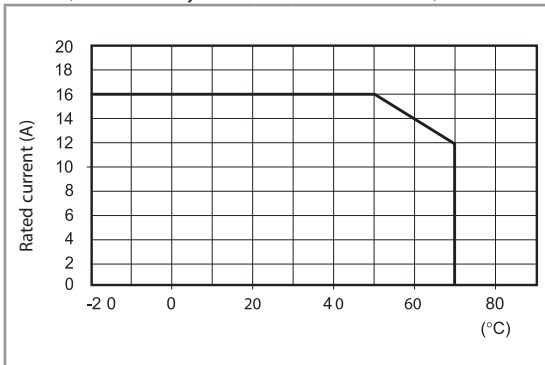

095.18



8-way jumper link for 97.01 and 97.02 sockets	095.18 (blue)	095.18.0 (black)
Rated values	10 A - 250 V	

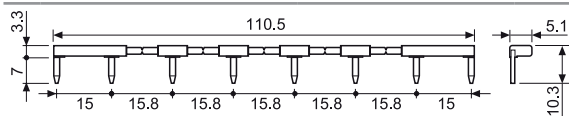

86.30

86 series timer modules	
(12...24)V AC/DC; Bi-function: AI, DI; (0.05 s...100 h)	86.30.0.024.0000
(110...125)V AC; Bi-function: AI, DI; (0.05 s...100 h)	86.30.8.120.0000
(230...240)V AC; Bi-function: AI, DI; (0.05 s...100 h)	86.30.8.240.0000

Approvals (according to type):



99.02

Approvals  
(according to type):



99.02 coil indication and EMC suppression modules for 97.01 and 97.02 sockets		
Diode (+A1, standard polarity)	(6...220)V DC	99.02.3.000.00
LED	(6...24)V DC/AC	99.02.0.024.59
LED	(28...60)V DC/AC	99.02.0.060.59
LED	(110...240)V DC/AC	99.02.0.230.59
LED + Diode (+A1, standard polarity)	(6...24)V DC	99.02.9.024.99
LED + Diode (+A1, standard polarity)	(28...60)V DC	99.02.9.060.99
LED + Diode (+A1, standard polarity)	(110...220)V DC	99.02.9.220.99
LED + Varistor	(6...24)V DC/AC	99.02.0.024.98
LED + Varistor	(28...60)V DC/AC	99.02.0.060.98
LED + Varistor	(110...240)V DC/AC	99.02.0.230.98
RC circuit	(6...24)V DC/AC	99.02.0.024.09
RC circuit	(28...60)V DC/AC	99.02.0.060.09
RC circuit	(110...240)V DC/AC	99.02.0.230.09
Residual current by-pass*	(110...240)V AC	99.02.8.230.07

\* Additional 0.9 W power dissipation



97.11

Approvals  
(according to type):



97.12

Approvals  
(according to type):



PCB socket	97.11 (blue)	97.12 (blue)
For relay type	46.61	46.52
<b>Technical data</b>		
Rated values	12 A - 250 V (see diagram L97)	8 A - 250 V
Dielectric strength	6 kV (1.2/50 µs) between coil and contacts	
Protection category	IP 20	
Ambient temperature	°C -40...+70	

**L 97 - Rated current v ambient temperature**  
(for 46.61 relay/97.11 socket combination)

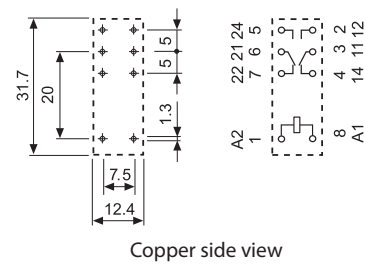
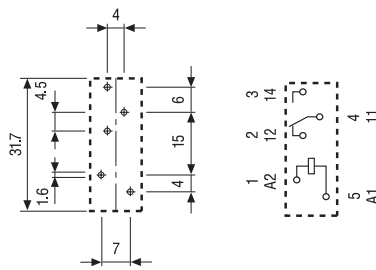
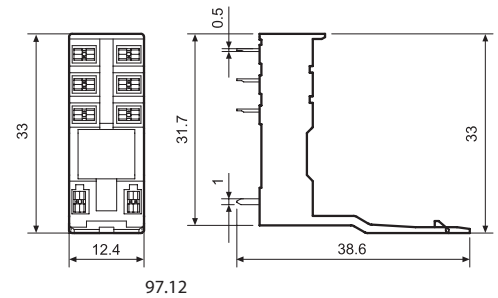
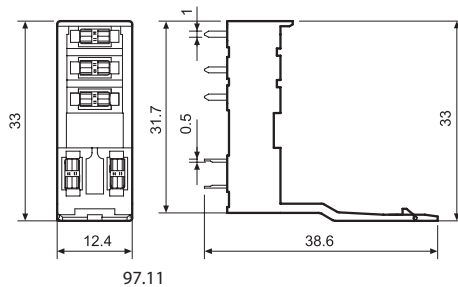
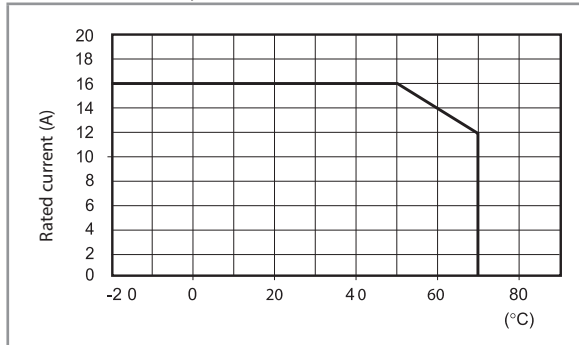

## Packaging codes

How to code and identify retaining clip and packaging options for sockets.

Example:



**A** Standard packaging

**SM** Metal retaining clip  
**SP** Plastic retaining clip





# General purpose relays 7 - 10 A



Automation for  
blinds, grilles  
and shutters



Control and  
management of  
electric power



Shipyards



Road / tunnel  
lighting



Hoists and  
cranes



Circuit breakers  
and switches



Control panels



Panels for electrical  
distribution

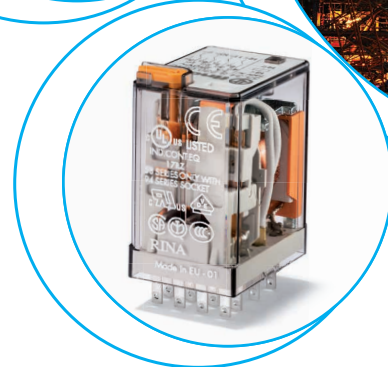
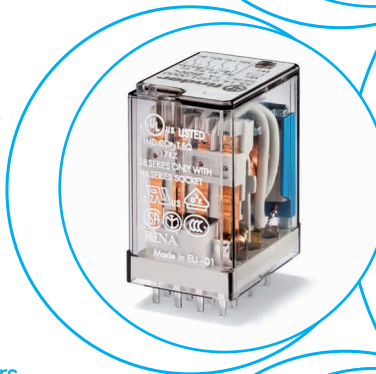



General purpose relays For printed circuit mounting		55.12	55.13	55.14
		<ul style="list-style-type: none"> <li>• 2 CO 10 A</li> <li>• PCB mount</li> </ul>	<ul style="list-style-type: none"> <li>• 3 CO 10 A</li> <li>• PCB mount</li> </ul>	<ul style="list-style-type: none"> <li>• 4 CO 7 A</li> <li>• PCB mount</li> </ul>
<b>Contact specification</b>				
Contact configuration		2 CO (DPDT)		4 CO (4PDT)
Rated current/Maximum peak current	A	10/20		7/15
Rated voltage/ Maximum switching voltage	V AC	250/400		250/250
Rated load AC1	VA	2500		1750
Rated load AC15 (230 V AC)	VA	500		350
Single phase motor rating (230 V AC)	kW	0.37		0.125
Breaking capacity DC1: 24/110/220 V	A	10/0.5/0.25		7/0.5/0.25
Minimum switching load	mW (V/mA)	300 (5/5)		300 (5/5)
Standard contact material		AgNi		AgNi
<b>Coil specification</b>				
Nominal voltage (U <sub>N</sub> )	V AC (50/60 Hz)	6 - 12 - 24 - 48 - 60 - 110 - 120 - 230 - 240		
	V DC	6 - 12 - 24 - 48 - 60 - 110 - 125 - 220		
Rated power AC/DC	VA (50 Hz)/W	1.5/1		1.5/1
Operating range	AC	(0.8...1.1)U <sub>N</sub>		(0.8...1.1)U <sub>N</sub>
	DC	(0.8...1.1)U <sub>N</sub>		(0.8...1.1)U <sub>N</sub>
Holding voltage	AC/DC	0.8 U <sub>N</sub> / 0.5 U <sub>N</sub>		0.8 U <sub>N</sub> / 0.5 U <sub>N</sub>
Must drop-out voltage	AC/DC	0.2 U <sub>N</sub> / 0.1 U <sub>N</sub>		0.2 U <sub>N</sub> / 0.1 U <sub>N</sub>
<b>Technical data</b>				
Mechanical life AC/DC	cycles	20 · 10 <sup>6</sup> / 50 · 10 <sup>6</sup>		20 · 10 <sup>6</sup> / 50 · 10 <sup>6</sup>
Electrical life at rated load AC1	cycles	200 · 10 <sup>3</sup>		150 · 10 <sup>3</sup>
Operate/release time	ms	10/5		9/5
Insulation between coil and contacts (1.2/50 μs)	kV	4		4
Dielectric strength between open contacts	V AC	1000		1000
Ambient temperature range	°C	-40...+85		-40...+85
Environmental protection		RT I		RT I
<b>Approvals</b> (according to type)				

FOR UL RATINGS SEE:  
"General technical information" page 7

For outline drawing see page 7

A

**General purpose relays**  
**For socket mounting**

**Type 55.32**

- 2 CO 10 A

**Type 55.33**

- 3 CO 10 A

**Type 55.34**

- 4 CO 7 A

- AC & DC coils
- Lockable test button and mechanical flag indicator as standard on 2 & 4 pole types
- Integral LED and coil suppression options
- 94 series sockets for PCB or 35 mm rail mounting (EN 60715) with Screw, Screwless or Push-in terminals
- Coil Indication and EMC suppression modules 99 series and Timer module 86.30 options
- Optional alternative mounting adaptors
- UL Listing (certain relay/socket combinations)
- Cadmium Free contacts
- Contact material options
- European Patent

FOR UL RATINGS SEE:

"General technical information" page V

For outline drawing see page 7

**Contact specification**

Contact configuration		2 CO (DPDT)	3 CO (3PDT)	4 CO (4PDT)
Rated current/Maximum peak current	A	10/20	10/20	7/15
Rated voltage/Maximum switching voltage	V AC	250/400	250/400	250/250
Rated load AC1	VA	2500	2500	1750
Rated load AC15 (230 V AC)	VA	500	500	350
Single phase motor rating (230 V AC)	kW	0.37	0.37	0.125
Breaking capacity DC1: 24/110/220 V	A	10/0.5/0.25	10/0.5/0.25	7/0.5/0.25
Minimum switching load	mW (V/mA)	300 (5/5)	300 (5/5)	300 (5/5)
Standard contact material		AgNi	AgNi	AgNi

**Coil specification**

Nominal voltage (U <sub>N</sub> )	V AC (50/60 Hz)	6 - 12 - 24 - 48 - 60 - 110 - 120 - 230 - 240		
	V DC	6 - 12 - 24 - 48 - 60 - 110 - 125 - 220		
Rated power AC/DC	VA (50 Hz)/W	1.5/1	1.5/1	1.5/1
Operating range	AC	(0.8...1.1)U <sub>N</sub>	(0.8...1.1)U <sub>N</sub>	(0.8...1.1)U <sub>N</sub>
	DC	(0.8...1.1)U <sub>N</sub>	(0.8...1.1)U <sub>N</sub>	(0.8...1.1)U <sub>N</sub>
Holding voltage	AC/DC	0.8 U <sub>N</sub> / 0.5 U <sub>N</sub>	0.8 U <sub>N</sub> / 0.5 U <sub>N</sub>	0.8 U <sub>N</sub> / 0.5 U <sub>N</sub>
Must drop-out voltage	AC/DC	0.2 U <sub>N</sub> / 0.1 U <sub>N</sub>	0.2 U <sub>N</sub> / 0.1 U <sub>N</sub>	0.2 U <sub>N</sub> / 0.1 U <sub>N</sub>

**Technical data**

Mechanical life AC/DC	cycles	20 · 10 <sup>6</sup> / 50 · 10 <sup>6</sup>	20 · 10 <sup>6</sup> / 50 · 10 <sup>6</sup>	20 · 10 <sup>6</sup> / 50 · 10 <sup>6</sup>
Electrical life at rated load AC1	cycles	200 · 10 <sup>3</sup>	200 · 10 <sup>3</sup>	150 · 10 <sup>3</sup>
Operate/release time	ms	10/5	9/5	9/5
Insulation between coil and contacts (1.2/50 μs)	kV	4	4	4
Dielectric strength between open contacts	V AC	1000	1000	1000
Ambient temperature range	°C	-40...+85	-40...+85	-40...+85
Environmental protection		RT I	RT I	RT I

**Approvals** (according to type)



- 55.32**
  - 2 CO 10 A
  - Plug-in 94 series sockets
- 55.33**
  - 3 CO 10 A
  - Plug-in 94 series sockets
- 55.34**
  - 4 CO 7 A
  - Plug-in 94 series sockets

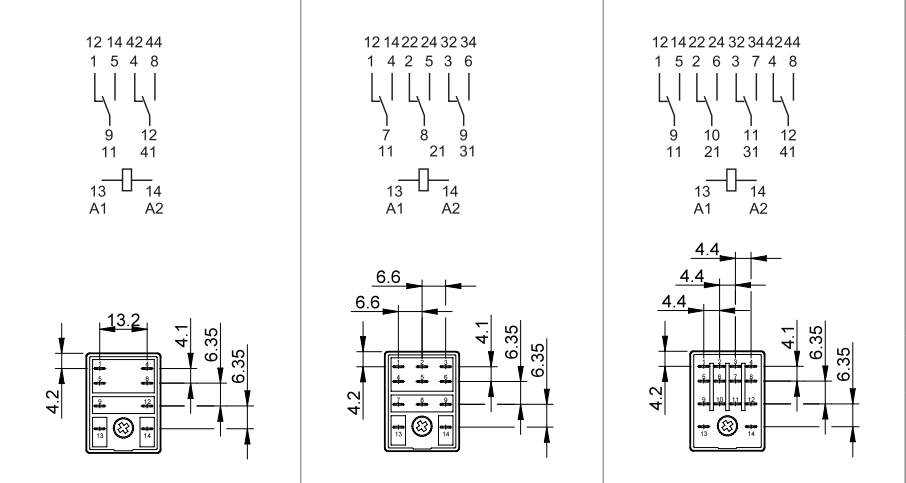

## Ordering information

Example: 55 series plug-in relay, 4 CO, 12 V DC coil, lockable test button and mechanical indicator.

**5 5 . 3 4 . 9 . 0 1 2 . 0 0 4 0**

**Series** ————

**Type**  
1 = PCB  
3 = Plug-in

**No. of poles**  
2 = 2 pole, 10 A  
3 = 3 pole, 10 A  
4 = 4 pole, 7 A

**Coil version**  
8 = AC (50/60 Hz)  
9 = DC

**Coil voltage**  
See coil specifications

**A: Contact material**  
0 = Standard AgNi  
5 = AgNi + Au

**B: Contact circuit**  
0 = CO (nPDT)

**C: Options**  
0 = None  
1 = Lockable test button  
2 = Mechanical indicator  
3 = LED (AC)  
4 = Lockable test button + mechanical indicator  
5 = Lockable test button + LED (AC)  
54 = Lockable test button + LED (AC) + mechanical indicator  
6\* = Double LED (DC non-polarized)  
7\* = Lockable test button + double LED (DC non-polarized)  
74\* = Lockable test button + double LED (DC non-polarized) + mechanical indicator  
8\* = LED + diode (DC, polarity positive to pin A1/13)  
9\* = Lockable test button + LED + diode (DC, polarity positive to pin A1/13)  
94\* = Lockable test button + LED + diode (DC, polarity positive to pin A1/13) + mechanical indicator  
\* Options not available for 220 V DC versions.

**D: Special versions**  
0 = Standard  
1 = Wash tight (RT III) for 55.12, 55.13 and 55.14 only

### Selecting features and options: only combinations in the same row are possible.

Preferred selections for best availability are shown in **bold**.

Type	Coil version	A	B	C	D
55.32/34	AC - DC	0 - 5	0	0	0
	AC	<b>0</b> - 5	<b>0</b>	2 - 3 - <b>4</b> - 5	<b>0</b>
	AC	0 - 5	0	54	/
	DC	<b>0</b> - 5	<b>0</b>	2 - <b>4</b> - 6 - 7 - 8 - 9	<b>0</b>
	DC	0 - 5	0	74 - 94	/
55.33	AC - DC	<b>0</b> - 5	<b>0</b>	<b>0</b>	<b>0</b>
	AC	0 - 5	0	1 - 3 - 5	0
	DC	0 - 5	0	1 - 6 - 7 - 8 - 9	0
55.12/13/14	AC - DC	<b>0</b> - 5	<b>0</b>	<b>0</b>	<b>0</b> - 1

### Descriptions: options and special versions

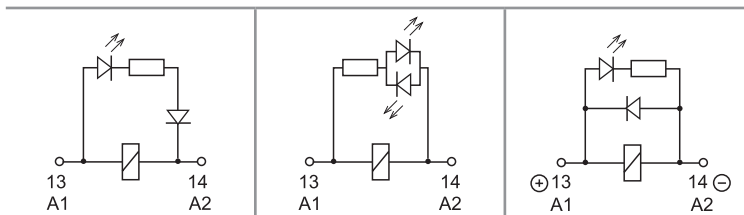

**C: Option 3, 5, 54**  
LED (AC)

**C: Option 6, 7, 74**  
Double LED  
(DC non-polarized)

**C: Option 8, 9, 94**  
LED + diode (DC, polarity positive to pin A1/13)

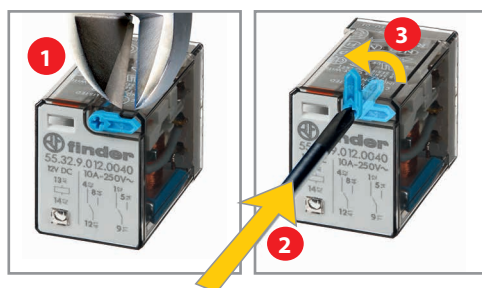

### Lockable test button and mechanical flag indicator (0010, 0040, 0050, 0054, 0070, 0074, 0090, 0094)



The dual-purpose Finder test button can be used in two ways:

**Case 1)** The plastic pip (located directly above the test button) remains intact. In this case, when the test button is pushed, the contacts operate. When the test button is released the contacts return to their former state.

**Case 2)** The plastic pip is broken-off (using an appropriate cutting tool). In this case, (in addition to the above function), when the test button is pushed and rotated, the contacts are latched in the operating state, and remain so until the test button is rotated back to its former position.

In both cases ensure that the test button actuation is swift and decisive.

Technical data

Insulation according to EN 61810-1		2 pole - 3 pole	4 pole
Nominal voltage of supply system	V AC	230/400	230
Rated insulation voltage	V AC	400	250
Pollution degree		2	2
<b>Insulation between coil and contact set</b>			
Type of Insulation		Basic	Basic
Overvoltage category		III	III
Rated impulse voltage	kV (1.2/50 μs)	4	4
Dielectric strength	V AC	2000	2000
<b>Insulation between adjacent contacts</b>			
Type of insulation		Basic	Basic
Overvoltage category		III	II
Rated impulse voltage	kV (1.2/50 μs)	4	2.5
Dielectric strength	V AC	2000	2000
<b>Insulation between open contacts</b>			
Type of disconnection		Micro-disconnection	Micro-disconnection
Dielectric strength	V AC/kV (1.2/50 μs)	1000/1.5	1000/1.5
<b>Insulation between coil terminals</b>			
Rated impulse voltage (surge) differential mode (according to EN 61000-4-5)	kV (1.2/50 μs)	4	
<b>Other data</b>			
Bounce time: NO/NC	ms	1/4 (2 pole), 1/6 (3 pole), 2/4 (4 pole)	
Vibration resistance (5...55)Hz: NO/NC	g	15/15	
Shock resistance	g	16	
Power lost to the environment	without contact current	W	1
	with rated current	W	3 (2 pole)      4 (3 pole)      3 (4 pole)
Recommended distance between relays mounted on PCB	mm	≥ 5	

Contact specification

F 55 - Electrical life (AC) v contact current  
2 and 3 pole relays

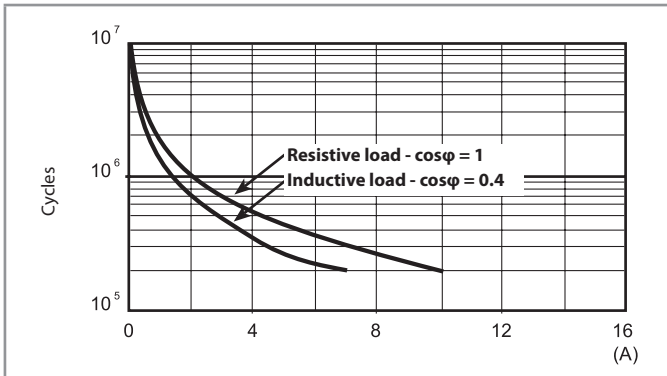

F 55 - Electrical life (AC) v contact current  
4 pole relays

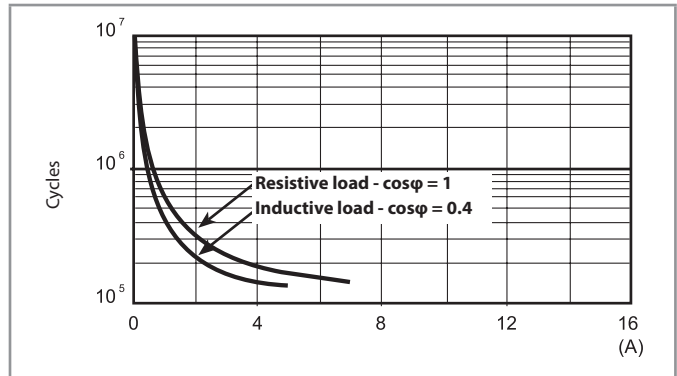

H 55 - Maximum DC1 breaking capacity

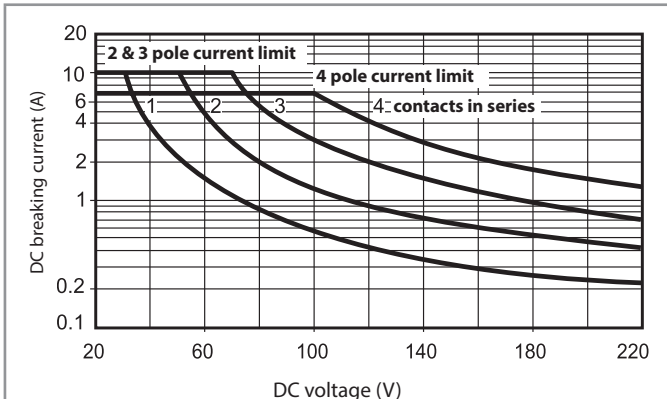

- When switching a resistive load (DC1) having voltage and current values under the curve, an electrical life of  $\geq 100 \cdot 10^3$  can be expected.
- In the case of DC13 loads, the connection of a diode in parallel with the load will permit a similar electrical life as for a DC1 load.  
Note: the release time of the load will be increased.

## Coil specifications

### DC coil data

Nominal voltage $U_N$ V	Coil code	Operating range		Resistance R $\Omega$	Rated coil consumption I at $U_N$ mA
		$U_{min}$ V	$U_{max}$ V		
6	9.006	4.8	6.6	40	150
12	9.012	9.6	13.2	140	86
24	9.024	19.2	26.4	600	40
48	9.048	38.4	52.8	2400	20
60	9.060	48	66	4000	15
110	9.110	88	121	12500	8.8
125	9.125	100	138	17300	7.2
220	9.220	176	242	54000	4

### AC coil data

Nominal voltage $U_N$ V	Coil code	Operating range		Resistance R $\Omega$	Rated coil consumption I at $U_N$ mA
		$U_{min}$ V	$U_{max}$ V		
6	8.006	4.8	6.6	12	200
12	8.012	9.6	13.2	50	97
24	8.024	19.2	26.4	190	53
48	8.048	38.4	52.8	770	25
60	8.060	48	66	1200	21
110	8.110	88	121	3940	12.5
120	8.120	96	132	4700	12
230	8.230	184	253	17000	6
240	8.240	192	264	19100	5.3

### R 55 - DC coil operating range v ambient temperature

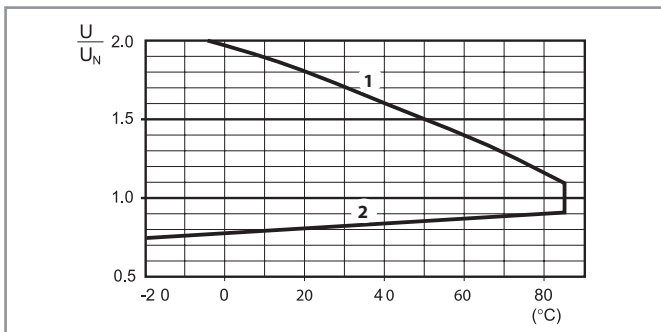

- 1 - Max. permitted coil voltage.  
2 - Min. pick-up voltage with coil at ambient temperature.

### R 55 - AC coil operating range v ambient temperature

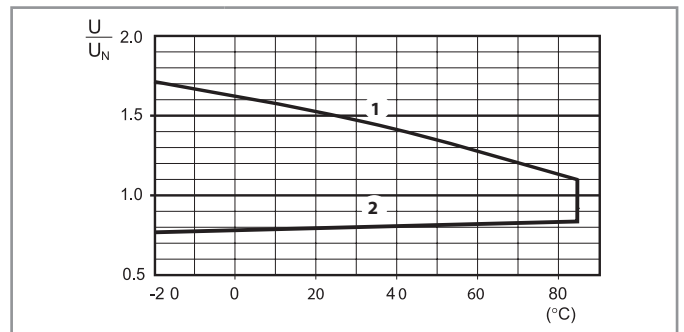

- 1 - Max. permitted coil voltage.  
2 - Min. pick-up voltage with coil at ambient temperature.

## Outline drawings

Type 55.12

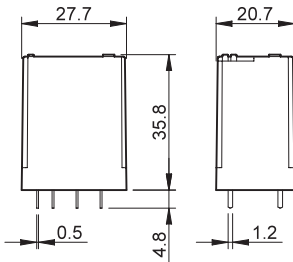

Type 55.13

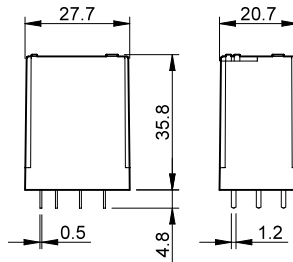

Type 55.14

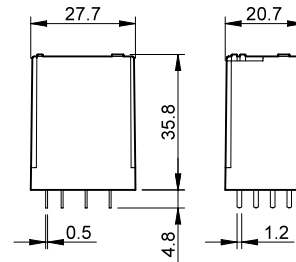

Type 55.32

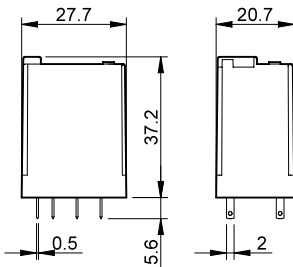

Type 55.33

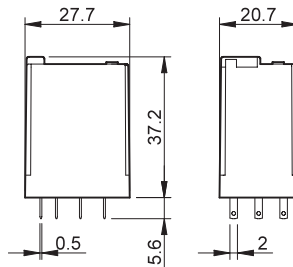

Type 55.34

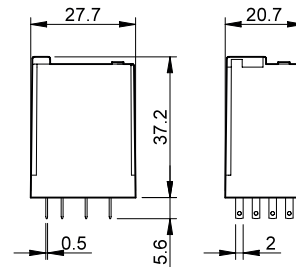

Accessories

A



056.25



056.25 with relay

Top flange mount adaptor for 55.32, 55.33, 55.34

056.25

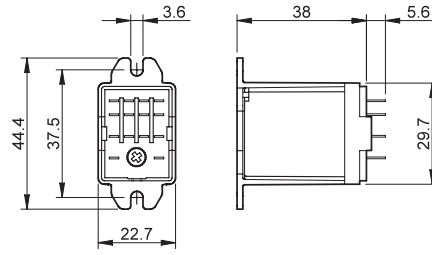

056.25 with relay



056.26



056.26 with relay

Rear flange mount adaptor for 55.32, 55.33, 55.34

056.26

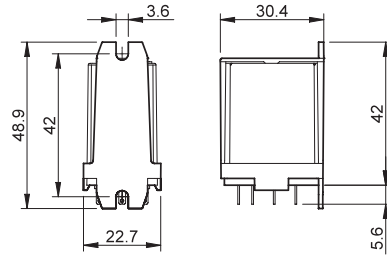

056.26 with relay



056.27



056.27 with relay

Top 35 mm rail (EN 60715) adaptor for 55.32, 55.33, 55.34

056.27

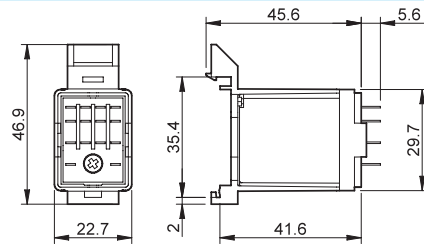

056.27 with relay



94.P4

See page 10



Module	Socket	Relay	Description	Mounting	Accessories
99.02	94.P3	55.33	<b>Push-in terminal socket</b> - For fast cable connections - Top terminals - Contacts - Bottom terminals - Coil	Panel or 35 mm rail (EN 60715) mount	- Coil indication and EMC suppression modules - Jumper link - Timer modules - Plastic retaining and release clip
	94.P4	55.32 55.34			

94.04

See page 12



Module	Socket	Relay	Description	Mounting	Accessories
99.02	94.02	55.32	<b>Screw terminal (Box clamp) socket</b> - Top terminals - Contacts - Bottom terminals - Coil	Panel or 35 mm rail (EN 60715) mount	- Coil indication and EMC suppression modules - Jumper link - Timer modules - Plastic retaining and release clip
	94.03	55.33			
	94.04	55.32 55.34			

94.54

See page 13

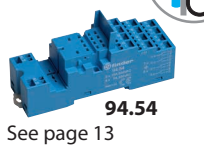

Module	Socket	Relay	Description	Mounting	Accessories
99.02	94.54	55.32	<b>Screwless terminal socket</b> - Top terminals - Contacts - Bottom terminals - Coil	Panel or 35 mm rail (EN 60715) mount	- Coil indication and EMC suppression modules - Jumper link - Timer modules - Plastic retaining and release clip
		55.34			

94.84.2

See page 14



Module	Socket	Relay	Description	Mounting	Accessories
99.80	94.84.2	55.32	<b>Screw terminal (Box clamp) socket</b>	Panel or 35 mm rail (EN 60715) mount	- Coil indication and EMC suppression modules - Jumper link - Plastic retaining and release clip
		55.34			

94.94.3

See page 15



Module	Socket	Relay	Description	Mounting	Accessories
99.80	94.92.3	55.32	<b>Screw terminal (Box clamp) socket</b> - Top terminals - Contacts - Bottom terminals - Coil	Panel or 35 mm rail (EN 60715) mount	- Coil indication and EMC suppression modules - Jumper link - Plastic retaining and release clip
		55.32			
		55.34			

94.74

See page 16



Module	Socket	Relay	Description	Mounting	Accessories
99.01	94.72	55.32	<b>Screw terminal (Plate clamp) socket</b> For 94.82: - 23 mm wide for space saving	Panel or 35 mm rail (EN 60715) mount	- Coil indication and EMC suppression modules - Plastic retaining and release clip
		55.33			
		55.32 55.34			
		55.32			

94.14

See page 17



Module	Socket	Relay	Description	Mounting	Accessories
—	94.12	55.32	<b>PCB socket</b>	PCB mounting	- Metal retaining clip
—	94.13	55.33			
—	94.14	55.32 55.34			

A



94.P4

Approvals  
(according to type):



Certain relay/socket combinations



094.91.3

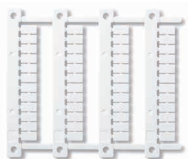

060.48

<b>Push-in terminal socket</b> panel or 35 mm (EN 60715) rail mount	<b>94.P3 Blue</b>	<b>94.P4 Blue</b>
For relay type	55.33	55.32, 55.34
<b>Accessories</b>		
Metal retaining clip		094.71
Plastic retaining and release clip (supplied with socket - packaging code SPA)		094.91.3
6-way jumper link		094.56
Identification tag		095.00.4
2-way jumper link		094.52.1
2-way jumper link		097.52
Marker tag holder		097.00
Modules (see table below)		99.02
Timer modules (see table below)		86.30
Sheet of marker tags for plastic retaining and release clip 094.91.3 and for marker tag holder 097.00, 48 tags, 6 x 12 mm for CEMBRE thermal transfer printers		060.48
<b>Technical data</b>		
Rated values	10 A - 250 V	
Dielectric strength	2 kV AC	
Protection category	IP 20	
Ambient temperature	°C -40...+70	
Wire strip length	mm 10	
Min. wire size for 94.P3 and 94.P4 sockets	solid wire	stranded wire
	mm <sup>2</sup> 0.5	0.5
	AWG 21	21
Max. wire size for 94.P3 and 94.P4 sockets	solid wire	stranded wire
	mm <sup>2</sup> 2 x 1.5 / 1 x 2.5	2 x 1.5 / 1 x 2.5
	AWG 2 x 16 / 1 x 14	2 x 16 / 1 x 14

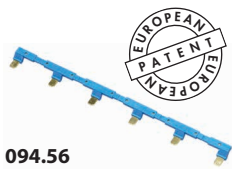
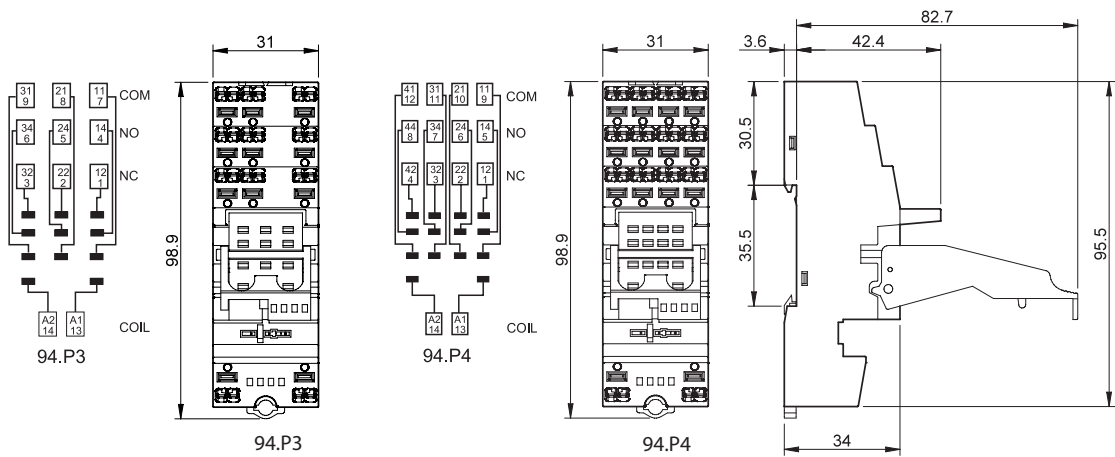

094.56

<b>6-way jumper link</b> for 94.P3 and 94.P4 sockets	094.56 (blue)
Rated values	10 A - 250 V

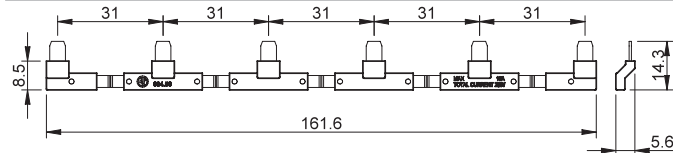

094.52.1

<b>2-way jumper link</b> for 94.P3 and 94.P4 sockets	094.52.1
Rated values	10 A - 250 V

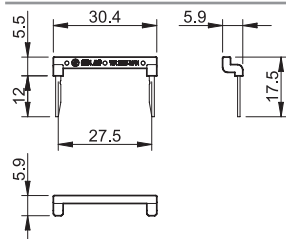



097.52

<b>2-way jumper link</b> for 94.P3 and 94.P4 sockets	097.52
Rated values	10 A - 250 V

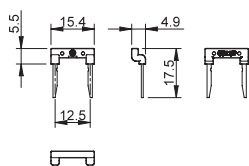

097.00

<b>Marker tag holder</b> for 94.P3 and 94.P4 sockets	097.00
--	--------

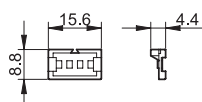

86.30

<b>86 series timer modules</b>	
(12...24)V AC/DC; Bi-function: AI, DI; (0.05 s...100 h)	86.30.0.024.0000
(110...125)V AC; Bi-function: AI, DI; (0.05 s...100 h)	86.30.8.120.0000
(230...240)V AC; Bi-function: AI, DI; (0.05 s...100 h)	86.30.8.240.0000

Approvals (according to type):



99.02

Approvals  
(according to type):



DC Modules with  
non-standard polarity  
(+A2) on request.

<b>99.02 coil indication and EMC suppression modules</b> for 94.P3 and 94.P4 sockets		
Diode (+A1, standard polarity)	(6...220)V DC	99.02.3.000.00
LED	(6...24)V DC/AC	99.02.0.024.59
LED	(28...60)V DC/AC	99.02.0.060.59
LED	(110...240)V DC/AC	99.02.0.230.59
LED + Diode (+A1, standard polarity)	(6...24)V DC	99.02.9.024.99
LED + Diode (+A1, standard polarity)	(28...60)V DC	99.02.9.060.99
LED + Diode (+A1, standard polarity)	(110...220)V DC	99.02.9.220.99
LED + Varistor	(6...24)V DC/AC	99.02.0.024.98
LED + Varistor	(28...60)V DC/AC	99.02.0.060.98
LED + Varistor	(110...240)V DC/AC	99.02.0.230.98
RC circuit	(6...24)V DC/AC	99.02.0.024.09
RC circuit	(28...60)V DC/AC	99.02.0.060.09
RC circuit	(110...240)V DC/AC	99.02.0.230.09
Residual current by-pass*	(110...240)V AC	99.02.8.230.07

\*Additional 0.9 W power dissipation

A



94.04

Approvals  
(according to type):



Certain relay/socket combinations



94.91.3

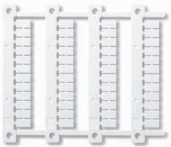

060.48

Screw terminal (Box clamp) socket panel or 35 mm (EN 60715) rail mount	94.02 Blue	94.02.0 Black	94.03 Blue	94.03.0 Black	94.04 Blue	94.04.0 Black
For relay type	55.32		55.33		55.32, 55.34	
<b>Accessories</b>						
Metal retaining clip	094.71					
Plastic retaining and release clip (supplied with socket - packaging code SPA)	094.91.3	094.91.30	094.91.3	094.91.30	094.91.3	094.91.30
6-way jumper link	094.06	094.06.0	094.06	094.06.0	094.06	094.06.0
Identification tag	094.00.4					
Marker tag holder	097.00					
Modules (see table below)	99.02					
Timer modules (see table below)	86.30					
Sheet of marker tags for plastic retaining and release clip 094.91.3 and for marker tag holder 097.00, 48 tags, 6 x 12 mm for CEMBRE thermal transfer printers	060.48					
<b>Technical data</b>						
Rated values	10 A - 250 V					
Dielectric strength	2 kV AC					
Protection category	IP 20					
Ambient temperature	°C -40...+70					
Screw torque	Nm	0.5				
Wire strip length	mm	8				
Max. wire size for 94.02/03/04 sockets	mm <sup>2</sup>	1 x 6 / 2 x 2.5		stranded wire		
	AWG	1 x 10 / 2 x 14		1 x 12 / 2 x 14		

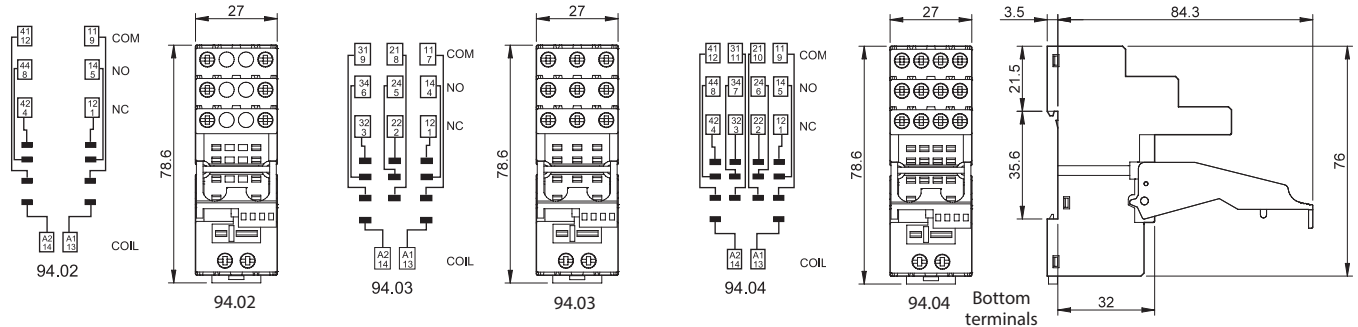

94.06

6-way jumper link for 94.02, 94.03 and 94.04 sockets	94.06 (blue)	94.06.0 (black)
Rated values	10 A - 250 V	

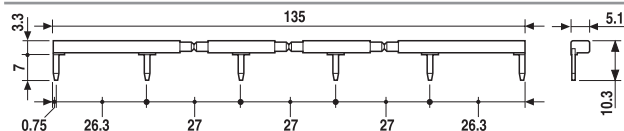

86.30

86 series timer modules	
(12...24)V AC/DC; Bi-function: AI, DI; (0.05 s...100 h)	86.30.0.024.0000
(110...125)V AC; Bi-function: AI, DI; (0.05 s...100 h)	86.30.8.120.0000
(230...240)V AC; Bi-function: AI, DI; (0.05 s...100 h)	86.30.8.240.0000

Approvals (according to type):



99.02

Approvals  
(according to type):



DC Modules with non-standard polarity (+A2) on request.

99.02 coil indication and EMC suppression modules for 94.02, 94.03 and 94.04 sockets		
Diode (+A1, standard polarity)	(6...220)V DC	99.02.3.000.00
LED	(6...24)V DC/AC	99.02.0.024.59
LED	(28...60)V DC/AC	99.02.0.060.59
LED	(110...240)V DC/AC	99.02.0.230.59
LED + Diode (+A1, standard polarity)	(6...24)V DC	99.02.9.024.99
LED + Diode (+A1, standard polarity)	(28...60)V DC	99.02.9.060.99
LED + Diode (+A1, standard polarity)	(110...220)V DC	99.02.9.220.99
LED + Varistor	(6...24)V DC/AC	99.02.0.024.98
LED + Varistor	(28...60)V DC/AC	99.02.0.060.98
LED + Varistor	(110...240)V DC/AC	99.02.0.230.98
RC circuit	(6...24)V DC/AC	99.02.0.024.09
RC circuit	(28...60)V DC/AC	99.02.0.060.09
RC circuit	(110...240)V DC/AC	99.02.0.230.09
Residual current by-pass*	(110...240)V AC	99.02.8.230.07

\*Additional 0.9 W power dissipation

A

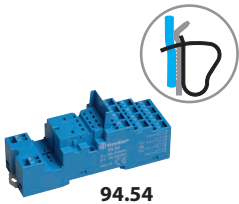

94.54

Approvals  
(according to type):



094.71

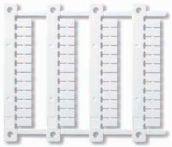

060.48

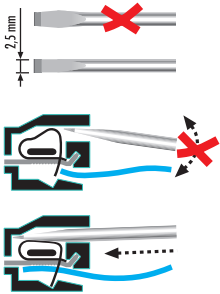

094.56



86.30



99.02

Approvals  
(according to type):



DC Modules with  
non-standard polarity  
(+A2) on request.

<b>Screwless terminal socket 35 mm rail (EN 60715) mount</b>		<b>94.54 (blue)</b>
For relay type		55.32, 55.34
<b>Accessories</b>		
Metal retaining clip		094.71
Plastic retaining and release clip		094.91.3
6-way jumper link		094.56
Modules (see table below)		99.02, 86.30
Sheet of marker tags for retaining and release clip 094.91.3, plastic, 48 tags, 6 x 12 mm for CEMBRE thermal transfer printers		060.48
<b>Technical data</b>		
Rated values		10 A - 250 V
Dielectric strength		2 kV AC
Protection category		IP 20
Ambient temperature °C		-25...+70
Wire strip length mm		10
Max. wire size for 94.54 sockets		solid wire
		stranded wire
		mm <sup>2</sup> 2 x (0.5...1.5)      2 x (0.5...1.5)
		AWG 2 x (21...14)      2 x (21...14)

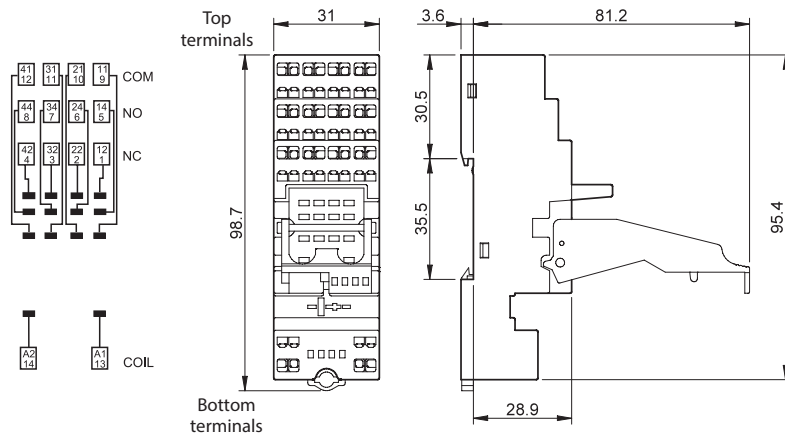

Sockets + jumper link

<b>6-way jumper link</b>	094.56 (blue)
Rated values	10 A - 250 V

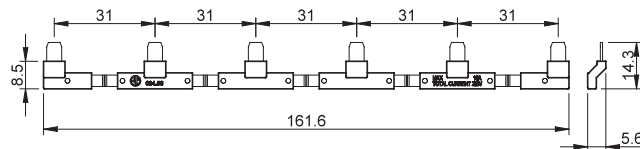

<b>86 series timer modules</b>		
(12...24)V AC/DC; Bi-function: AI, DI; (0.05 s...100 h)	86.30.0.024.0000	
(110...125)V AC; Bi-function: AI, DI; (0.05 s...100 h)	86.30.8.120.0000	
(230...240)V AC; Bi-function: AI, DI; (0.05 s...100 h)	86.30.8.240.0000	

Approvals (according to type):

<b>99.02 coil indication and EMC suppression modules for 94.54 sockets</b>		
Diode (+A1, standard polarity)	(6...220)V DC	99.02.3.000.00
LED	(6...24)V DC/AC	99.02.0.024.59
LED	(28...60)V DC/AC	99.02.0.060.59
LED	(110...240)V DC/AC	99.02.0.230.59
LED + Diode (+A1, standard polarity)	(6...24)V DC	99.02.9.024.99
LED + Diode (+A1, standard polarity)	(28...60)V DC	99.02.9.060.99
LED + Diode (+A1, standard polarity)	(110...220)V DC	99.02.9.220.99
LED + Varistor	(6...24)V DC/AC	99.02.0.024.98
LED + Varistor	(28...60)V DC/AC	99.02.0.060.98
LED + Varistor	(110...240)V DC/AC	99.02.0.230.98
RC circuit	(6...24)V DC/AC	99.02.0.024.09
RC circuit	(28...60)V DC/AC	99.02.0.060.09
RC circuit	(110...240)V DC/AC	99.02.0.230.09
Residual current by-pass*	(110...240)V AC	99.02.8.230.07

\*Additional 0.9 W power dissipation

A



94.84.2

Approvals  
(according to type):



094.91.3

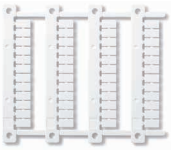

060.48

<b>Screw terminal (Box clamp) socket panel or 35 mm (EN 60715) rail mount</b>	<b>94.84.2</b>	<b>94.84.20</b>
For relay type	55.32, 55.34	
<b>Accessories</b>		
Metal retaining clip (supplied with socket - packaging code SMA)		094.71
Plastic retaining and release clip	094.91.3	094.91.30
6-way jumper link	094.06	094.06.0
Identification tag		094.80.3
Modules (see table below)		99.80
Sheet of marker tags for retaining and release clip 094.91.3, plastic, 48 tags, 6 x 12 mm for CEMBRE thermal transfer printers		060.48
<b>Technical data</b>		
Rated values	10 A - 250 V	
Dielectric strength	2 kV AC	
Protection category	IP 20	
Ambient temperature	°C -40...+70	
Screw torque	Nm	0.5
Wire strip length	mm 7	
Max. wire size for 94.84.2 socket	solid wire	stranded wire
	mm <sup>2</sup>	1 x 6 / 2 x 2.5
	AWG	1 x 12 / 2 x 14

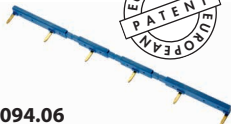
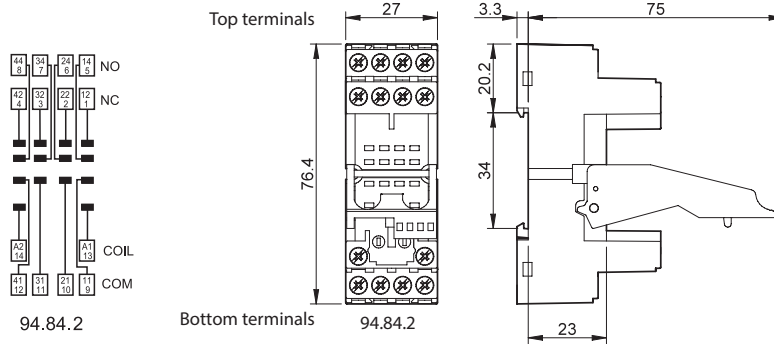

094.06



<b>6-way jumper link for 94.84.2 socket</b>	<b>094.06 (blue)</b>	<b>094.06.0 (black)</b>
Rated values	10 A - 250 V	

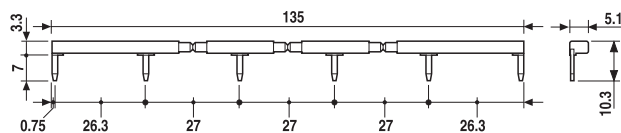

99.80

Approvals  
(according to type):



\* Modules in Black housing are available on request.

Green LED is standard.  
Red LED available on request.

<b>99.80 coil indication and EMC suppression modules for 94.84.2 socket</b>		<b>Blue*</b>
Diode (+A1, standard polarity)	(6...220)V DC	99.80.3.000.00
LED	(6...24)V DC/AC	99.80.0.024.59
LED	(28...60)V DC/AC	99.80.0.060.59
LED	(110...240)V DC/AC	99.80.0.230.59
LED + Diode (+A1, standard polarity)	(6...24)V DC	99.80.9.024.99
LED + Diode (+A1, standard polarity)	(28...60)V DC	99.80.9.060.99
LED + Diode (+A1, standard polarity)	(110...220)V DC	99.80.9.220.99
LED + Varistor	(6...24)V DC/AC	99.80.0.024.98
LED + Varistor	(28...60)V DC/AC	99.80.0.060.98
LED + Varistor	(110...240)V DC/AC	99.80.0.230.98
RC circuit	(6...24)V DC/AC	99.80.0.024.09
RC circuit	(28...60)V DC/AC	99.80.0.060.09
RC circuit	(110...240)V DC/AC	99.80.0.230.09
Residual current by-pass*	(110...240)V AC	99.80.8.230.07

\*Additional 0.9 W power dissipation



A

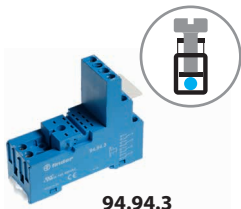

94.94.3

Approvals  
(according to type):



094.91.3

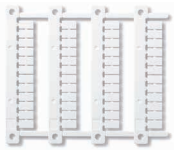

060.48

Screw terminal (Box clamp) socket panel or 35 mm rail mount	94.92.3 (blue)	94.92.30 (black)	94.94.3 (blue)	94.94.30 (black)
For relay type	55.32		55.32, 55.34	
<b>Accessories</b>				
Metal retaining clip	094.71			
Plastic retaining and release clip	094.91.3	094.91.30	094.91.3	094.91.30
6-way jumper link	094.06	094.06.0	094.06	094.06.0
Identification tag	094.80.3			
Modules (see table below)	99.80			
Sheet of marker tags for retaining and release clip 094.91.3, plastic, 48 tags, 6 x 12 mm for CEMBRE thermal transfer printers	060.48			
<b>Technical data</b>				
Rated values	10 A - 250 V			
Dielectric strength	2 kV AC			
Protection category	IP 20			
Ambient temperature	°C -25...+70			
Screw torque	Nm 0.5			
Wire strip length	mm 8			
Max. wire size for 94.92.3 and 94.94.3 sockets	solid wire		stranded wire	
	mm <sup>2</sup> 1 x 6 / 2 x 2.5		1 x 4 / 2 x 2.5	
	AWG 1 x 10 / 2 x 14		1 x 12 / 2 x 14	

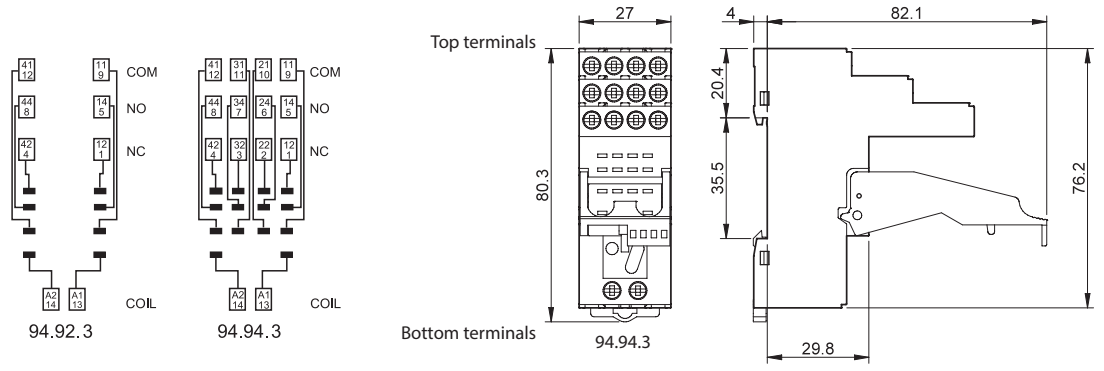

094.06



6-way jumper link for 94.92.3 and 94.94.3 sockets	094.06 (blue)	094.06.0 (black)
Rated values	10 A - 250 V	

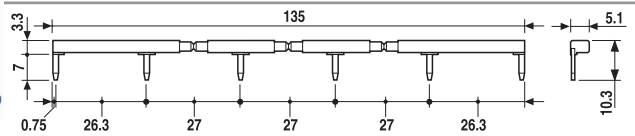

99.80

Approvals  
(according to type):



\* Modules in Black housing are available on request.

Green LED is standard. Red LED available on request.

99.80 coil indication and EMC suppression modules for 94.92.3 and 94.94.3 sockets		Blue*
Diode (+A1, standard polarity)	(6...220)V DC	99.80.3.000.00
LED	(6...24)V DC/AC	99.80.0.024.59
LED	(28...60)V DC/AC	99.80.0.060.59
LED	(110...240)V DC/AC	99.80.0.230.59
LED + Diode (+A1, standard polarity)	(6...24)V DC	99.80.9.024.99
LED + Diode (+A1, standard polarity)	(28...60)V DC	99.80.9.060.99
LED + Diode (+A1, standard polarity)	(110...220)V DC	99.80.9.220.99
LED + Varistor	(6...24)V DC/AC	99.80.0.024.98
LED + Varistor	(28...60)V DC/AC	99.80.0.060.98
LED + Varistor	(110...240)V DC/AC	99.80.0.230.98
RC circuit	(6...24)V DC/AC	99.80.0.024.09
RC circuit	(28...60)V DC/AC	99.80.0.060.09
RC circuit	(110...240)V DC/AC	99.80.0.230.09
Residual current by-pass*	(110...240)V AC	99.80.8.230.07

\*Additional 0.9 W power dissipation

A



94.74

Approvals  
(according to type):



94.82

Approvals  
(according to type):



<b>Screw terminal (Plate clamp) socket panel or 35 mm (EN 60715) rail mount</b>	<b>94.72</b>	<b>94.72.0</b>	<b>94.73</b>	<b>94.73.0</b>	<b>94.74</b>	<b>94.74.0</b>
	<b>Blue</b>	<b>Black</b>	<b>Blue</b>	<b>Black</b>	<b>Blue</b>	<b>Black</b>
For relay type	55.32		55.33		55.32, 55.34	
<b>Accessories</b>						
Metal retaining clip (supplied with socket - packaging code SMA)					094.71	
Modules (see table below)					99.01	
<b>Screw terminal (Plate clamp) socket: panel or 35 mm rail mount</b>	<b>94.82 (blue)</b>		<b>94.82.0 (black)</b>			
For relay type	55.32		55.32			
<b>Accessories</b>						
Metal retaining clip (supplied with socket - packaging code SMA)					094.71	
Modules (see table below)					99.01	
<b>Technical data</b>						
Rated values	10 A - 250 V					
Dielectric strength	2 kV AC					
Protection category	IP 20					
Ambient temperature	°C -40...+70					
Screw torque	Nm 0.5					
Wire strip length	mm 8 (94.72/73/74)		9 (94.82)			
Max. wire size for 94.72/73/74 and 94.82 sockets	solid wire		stranded wire			
	mm <sup>2</sup> 1 x 2.5 / 2 x 1.5		1 x 2.5 / 2 x 1.5			
	AWG 1 x 14 / 2 x 16		1 x 14 / 2 x 16			

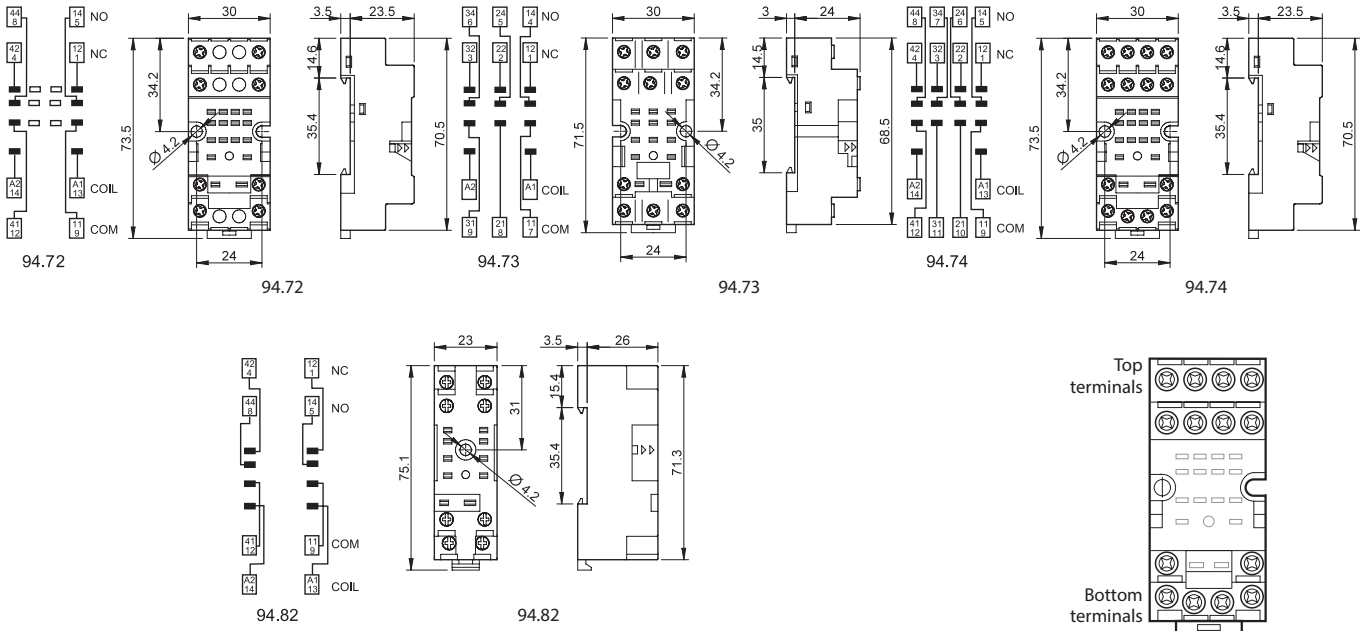

**99.01 coil indication and EMC suppression modules for 94.72, 94.73, 94.74 and 94.82 sockets**

		<b>Blue*</b>
Diode (+A1, standard polarity)	(6...220)V DC	99.01.3.000.00
Diode (+A2, non standard polarity)	(6...220)V DC	99.01.3.000.00
LED	(6...24)V DC/AC	99.01.0.024.59
LED	(28...60)V DC/AC	99.01.0.060.59
LED	(110...240)V DC/AC	99.01.0.230.59
LED + Diode (+A1, standard polarity)	(6...24)V DC	99.01.9.024.99
LED + Diode (+A1, standard polarity)	(28...60)V DC	99.01.9.060.99
LED + Diode (+A1, standard polarity)	(110...220)V DC	99.01.9.220.99
LED + Diode (+A2, non standard polarity)	(6...24)V DC	99.01.9.024.79
LED + Diode (+A2, non standard polarity)	(28...60)V DC	99.01.9.060.79
LED + Diode (+A2, non standard polarity)	(110...220)V DC	99.01.9.220.79
LED + Varistor	(6...24)V DC/AC	99.01.0.024.98
LED + Varistor	(28...60)V DC/AC	99.01.0.060.98
LED + Varistor	(110...240)V DC/AC	99.01.0.230.98
RC circuit	(6...24)V DC/AC	99.01.0.024.09
RC circuit	(28...60)V DC/AC	99.01.0.060.09
RC circuit	(110...240)V DC/AC	99.01.0.230.09
Residual current by-pass*	(110...240)V AC	99.01.8.230.07

\*Additional 0.9 W power dissipation

99.01

Approvals  
(according to type):



\* Modules in Black housing are available on request.

Green LED is standard.  
Red LED available on request.



A



94.14

Approvals  
(according to type):



PCB socket	94.12 Blue	94.12.0 Black	94.13 Blue	94.13.0 Black	94.14 Blue	94.14.0 Black
For relay type	55.32		55.33		55.32, 55.34	
<b>Accessories</b>						
Metal retaining clip (supplied with socket - packaging code SMA)	094.51					
<b>Technical data</b>						
Rated values	10 A - 250 V					
Dielectric strength	2 kV AC					
Ambient temperature	°C -40...+70					

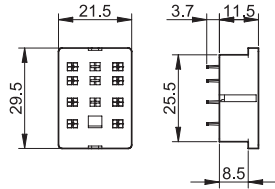

Copper side view

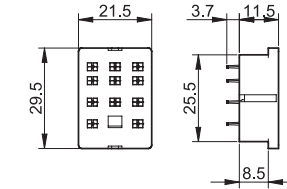

Copper side view

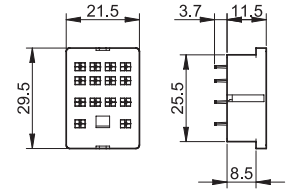

Copper side view

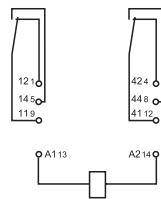
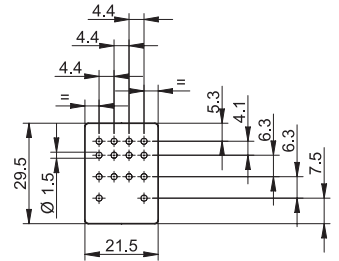
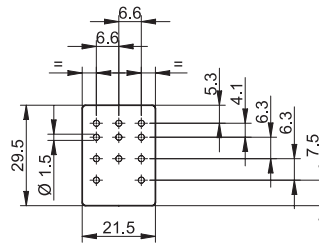
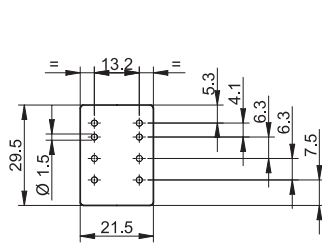

94.12

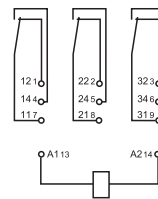

94.13

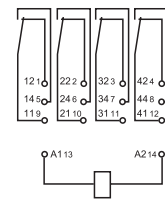

94.14

### Packaging codes

How to code and identify retaining clip and packaging options for sockets.

Example:



A Standard packaging

SM Metal retaining clip  
SP Plastic retaining clip



# Miniature power relays 12 A



Industrial furnaces and ovens



Control and management of electric power



Industrial motors



Circuit breakers and switches



Panels for electrical distribution



Control panels



Carousel warehouses



Vending machines

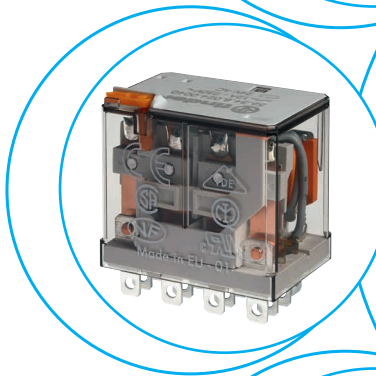
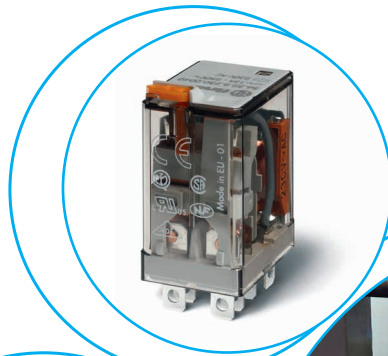



**Plug-in - 12 A Power relay, 2 & 4 pole**

- Flange mount option - (Faston 187, 4.8 x 0.5 mm termination)
- AC coils & DC coils
- Lockable test button and mechanical flag indicator
- Cadmium Free contacts (standard version)
- Contact material options
- 96 series sockets
- Coil EMC suppression
- Accessories
- European Patent

**56.32/56.34**

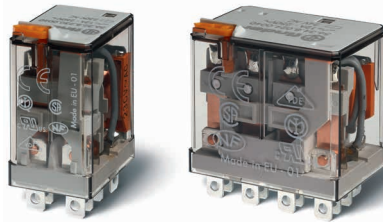

- 2 or 4 pole changeover contact
- Plug-in/Faston 187

**56.32-0300**



- 2 pole normally open contact ( $\geq 1.5$  mm gap)
- Plug-in/Faston 187

\* For 4 CO (4PDT) only.

FOR UL RATINGS SEE:

"General technical information" page V

For outline drawing see page 8

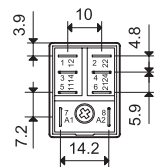
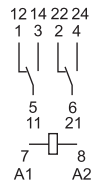

56.32

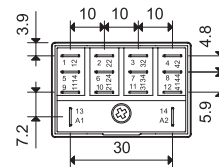
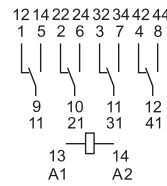

56.34

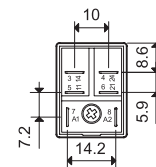
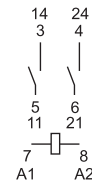

56.32-0300

Contact specification		2 CO (DPDT)	4 CO (4PDT)	2NO (DPST-NO) - $\geq 1.5$ mm gap
Contact configuration		2 CO (DPDT)	4 CO (4PDT)	2NO (DPST-NO) - $\geq 1.5$ mm gap
Rated current/Maximum peak current	A	12/20		12/20
Rated voltage/ Maximum switching voltage	V AC	250/400		250/400
Rated load AC1	VA	3000		3000
Rated load AC15 (230 V AC)	VA	700		700
Single phase motor rating (230 V AC)	kW	0.55		0.55
Breaking capacity DC1: 24/110/220 V	A	12/0.5/0.25		12/1/0.5
Minimum switching load	mW (V/mA)	500 (10/5)		500 (10/5)
Standard contact material		AgNi		AgNi
Coil specification				
Nominal voltage ( $U_N$ )	V AC (50/60 Hz)	6 - 12 - 24 - 48 - 60 - 110 - 120 - 230 - 240 - 400*		
	V DC	6 - 12 - 24 - 48 - 60 - 110 - 125 - 220		—
Rated power AC/DC	VA (50 Hz)/W	1.5/1	2/1.3	1.5/—
Operating range	AC	$(0.8 \dots 1.1) U_N$		$(0.85 \dots 1.1) U_N$
	DC	$(0.8 \dots 1.1) U_N$	$(0.8 \dots 1.1) U_N$	—
Holding voltage	AC/DC	$0.8 U_N / 0.6 U_N$		$0.85 U_N / —$
Must drop-out voltage	AC/DC	$0.2 U_N / 0.1 U_N$		$0.2 U_N / —$
Technical data				
Mechanical life AC/DC	cycles	$20 \cdot 10^6 / 50 \cdot 10^6$		$20 \cdot 10^6 / —$
Electrical life at rated load AC1	cycles	$100 \cdot 10^3$		$100 \cdot 10^3$
Operate/release time	ms	9/6	11/11	8/4
Insulation between coil and contacts (1.2/50 $\mu$ s)	kV	4	5	4
Dielectric strength between open contacts	V AC	1000		2000
Ambient temperature range	$^{\circ}$ C	-40...+70		-40...+70
Environmental protection		RT I		RT I
<b>Approvals</b> (according to type)				

**Printed circuit mount  
12 A Power relay**

- 2 & 4 pole
- AC coils & DC coils
- Cadmium Free contacts (standard version)
- Contact material option

A

**56.42/56.44**

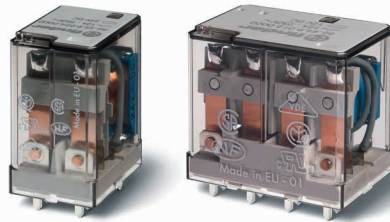

- 2 or 4 pole changeover contact
- PCB mount

**56.42-0300**



- 2 pole normally open contact ( $\geq 1.5$  mm gap)
- PCB mount

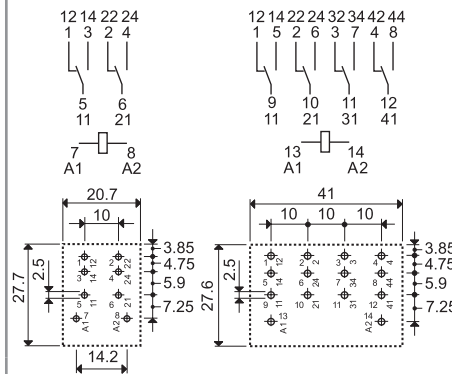

56.42  
Copper side view

56.44  
Copper side view

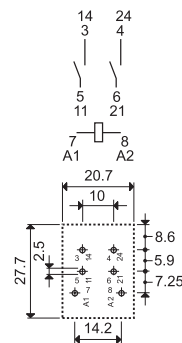

56.42-0300  
Copper side view

\* For 4 CO (4PDT) only.

FOR UL RATINGS SEE:

"General technical information" page V

For outline drawing see page 8

**Contact specification**

Contact configuration		2 CO (DPDT)	4 CO (4PDT)	2NO (DPST-NO) - $\geq 1.5$ mm gap
Rated current/Maximum peak current	A	12/20		12/20
Rated voltage/ Maximum switching voltage	V AC	250/400		250/400
Rated load AC1	VA	3000		3000
Rated load AC15 (230 V AC)	VA	700		700
Single phase motor rating (230 V AC)	kW	0.55		0.55
Breaking capacity DC1: 24/110/220 V	A	12/0.5/0.25		12/1/0.5
Minimum switching load	mW (V/mA)	500 (10/5)		500 (10/5)
Standard contact material		AgNi		AgNi

**Coil specification**

Nominal voltage ( $U_N$ )	V AC (50/60 Hz)	6 - 12 - 24 - 48 - 60 - 110 - 120 - 230 - 240 - 400*		
	V DC	6 - 12 - 24 - 48 - 60 - 110 - 125 - 220		—
Rated power AC/DC	VA (50 Hz)/W	1.5/1	2/1.3	1.5/—
Operating range	AC	(0.8...1.1) $U_N$		(0.85...1.1) $U_N$
	DC	(0.8...1.1) $U_N$	(0.8...1.1) $U_N$	—
Holding voltage	AC/DC	0.8 $U_N$ / 0.6 $U_N$		0.85 $U_N$ /—
Must drop-out voltage	AC/DC	0.2 $U_N$ / 0.1 $U_N$		0.2 $U_N$ /—

**Technical data**

Mechanical life AC/DC	cycles	20 · 10 <sup>6</sup> /50 · 10 <sup>6</sup>		20 · 10 <sup>6</sup> /—
Electrical life at rated load AC1	cycles	100 · 10 <sup>3</sup>		100 · 10 <sup>3</sup>
Operate/release time	ms	9/6	11/11	8/4
Insulation between coil and contacts (1.2/50 $\mu$ s)	kV	4	5	4
Dielectric strength between open contacts	V AC	1000		2000
Ambient temperature range	°C	-40...+70		-40...+70
Environmental protection		RT I		RT I

Approvals (according to type)



## Ordering information

Example: 56 series plug-in relay, 2 CO (DPDT), 12 V DC coil, lockable test button and mechanical indicator.

<p><b>Series</b> —————</p> <p><b>Type</b> —————</p> <p>3 = Plug-in 4 = PCB</p> <p><b>No. of poles</b> —————</p> <p>2 = 2 pole, 12 A 4 = 4 pole, 12 A</p> <p><b>Coil version</b> —————</p> <p>8 = AC (50/60 Hz) 9 = DC</p> <p><b>Coil voltage</b> —————</p> <p>See coil specifications</p>	<p><b>5 6 . 3 2 . 9 . 0 1 2 . 0 0 4 0</b></p>	<p><b>A: Contact material</b> 0 = Standard AgNi 2 = AgCdO 4 = AgSnO<sub>2</sub></p> <p><b>B: Contact circuit</b> 0 = CO (nPDT) 3 = NO (nPST), ≥ 1.5 mm contact gap</p>	<p><b>D: Special versions</b> 0 = Standard 6 = Rear flange mount (4 pole only) For other mounting options see page 9</p> <p><b>C: Options</b> 0 = None 2 = Mechanical indicator 3* = LED (AC) 4 = Lockable test button + mechanical indicator 5* = Lockable test button + LED (AC) 54* = Lockable test button + LED (AC) + mechanical indicator 6* = Double LED (DC non-polarized) 7* = Lockable test button + double LED (DC non-polarized) 74* = Lockable test button + double LED (DC non-polarized) + mechanical indicator 8* = LED + diode (DC, polarity positive to pin 7) for 56.32 only 9* = Lockable test button + LED + diode (DC, polarity positive to pin 7) for 56.32 only 94* = Lockable test button + LED + diode (DC, polarity positive to pin 7) + mechanical indicator for 56.32 only</p> <p>* Options not available for 220 V DC and 400 V AC versions.</p>
---	---	--	--

### Selecting features and options: only combinations in the same row are possible.

Preferred selections for best availability are shown in **bold**.

Type	Coil version	A	B	C	D
56.32	AC	<b>0 - 2 - 4</b>	<b>0</b>	0 - 2 - 3 - <b>4</b> - 5	<b>0</b>
	AC	0 - 2 - 4	0	54	/
	AC	0 - 2 - 4	3	0 - 3 - 5	0
	DC	<b>0 - 2 - 4</b>	<b>0</b>	0 - 2 - <b>4</b> - 6 - 7 - 8 - 9	<b>0</b>
	DC	0 - 2 - 4	0	<b>74 - 94</b>	/
56.34	AC	<b>0 - 2 - 4</b>	<b>0</b>	<b>0 - 2 - 3 - 4 - 5</b>	<b>0 - 6</b>
	AC	0 - 2 - 4	0	54	/
	DC	<b>0 - 2 - 4</b>	<b>0</b>	<b>0 - 2 - 4 - 6 - 7</b>	<b>0 - 6</b>
	DC	0 - 2 - 4	0	<b>74</b>	/
56.42	DC	<b>0 - 2 - 4</b>	<b>0</b>	<b>0</b>	<b>0</b>
	AC	0 - 2 - 4	0 - 3	0	0
56.44	AC - DC	<b>0 - 2 - 4</b>	<b>0</b>	<b>0</b>	<b>0</b>

### Special versions for Rail Applications on request

### Descriptions: options and special versions

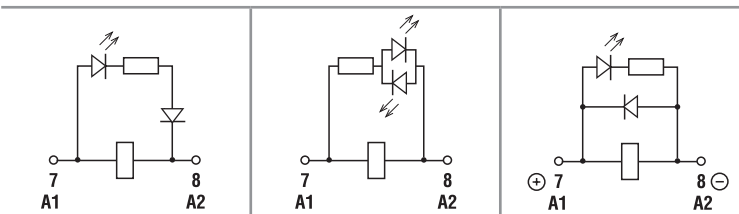

**C: Option 3, 5, 54**  
LED (AC)

**C: Option 6, 7, 74**  
Double LED  
(DC non-polarized)

**C: Option 8, 9, 94**  
LED + diode (DC, polarity  
positive to pin 7) -  
(56.32 only)

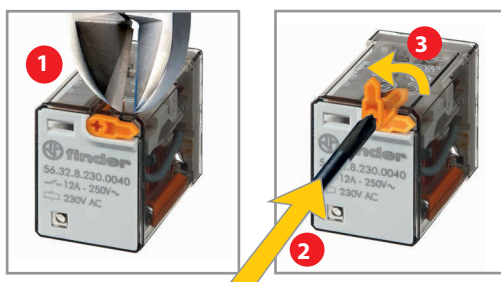

### Lockable test button and mechanical flag indicator (0040, 0050, 0054, 0070, 0074, 0090, 0094)

The dual-purpose Finder test button can be used in two ways:

**Case 1)** The plastic pip (located directly above the test button) remains intact. In this case, when the test button is pushed, the contacts operate. When the test button is released the contacts return to their former state.

**Case 2)** The plastic pip is broken-off (using an appropriate cutting tool). In this case, (in addition to the above function), when the test button is pushed and rotated, the contacts are latched in the operating state, and remain so until the test button is rotated back to its former position.

In both cases ensure that the test button actuation is swift and decisive.

**Technical data**

\* Only in applications where over voltage category II is permitted. In applications of over voltage category III: Micro-disconnection.

Insulation according to EN 61810-1		2 CO - 4 CO		2 NO	
Nominal voltage of supply system	V AC	230/400		230/400	
Rated insulation voltage	V AC	250	400	250	400
Pollution degree		3	2	3	2
<b>Insulation between coil and contact set</b>					
Type of Insulation		Basic		Basic	
Overvoltage category		III		III	
Rated impulse voltage	kV (1.2/50 μs)	4		4	
Dielectric strength	V AC	2500		2500	
<b>Insulation between adjacent contacts</b>					
Type of insulation		Basic		Basic	
Overvoltage category		III		III	
Rated impulse voltage	kV (1.2/50 μs)	4		4	
Dielectric strength	V AC	2500		2500	
<b>Insulation between open contacts</b>					
Type of disconnection		Micro-disconnection		Full-disconnection*	
Overvoltage category		—		II	
Rated impulse voltage	kV (1.2/50 μs)	—		2.5	
Dielectric strength	V AC/kV (1.2/50 μs)	1000/1.5		2000/3	
<b>Insulation between coil terminals</b>					
Rated impulse voltage (surge) differential mode (according to EN 61000-4-5)	kV (1.2/50 μs)	4			
<b>Other data</b>					
Bounce time: NO/NC	ms	1/4 (2 CO) , 1/7 (4 CO)		3/— (normally open)	
Vibration resistance (5...55)Hz: NO/NC	g	17/14			
Shock resistance	g	20/14			
Power lost to the environment	without contact current	W	1 (56.32, 56.42)		1.3 (56.34, 56.44)
	with rated current	W	3.8 (56.32, 56.42)		6.9 (56.34, 56.44)
Recommended distance between relays mounted on PCB	mm	≥ 5			

**Contact specification**

**F 56 - Electrical life (AC) v contact current**

2 - 4 pole relays

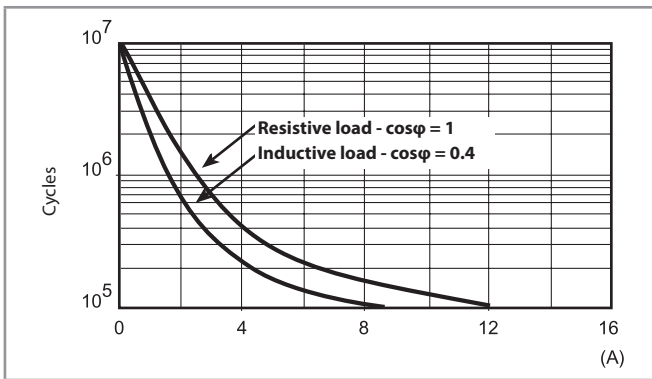

**H 56 - Maximum DC1 breaking capacity**

Changeover version

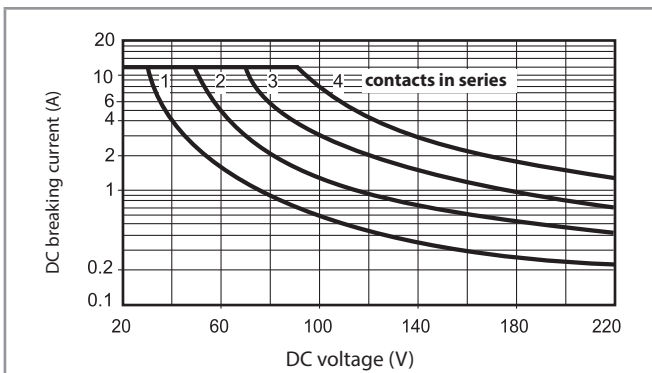

**H 56 - Maximum DC1 breaking capacity**

Normally open version

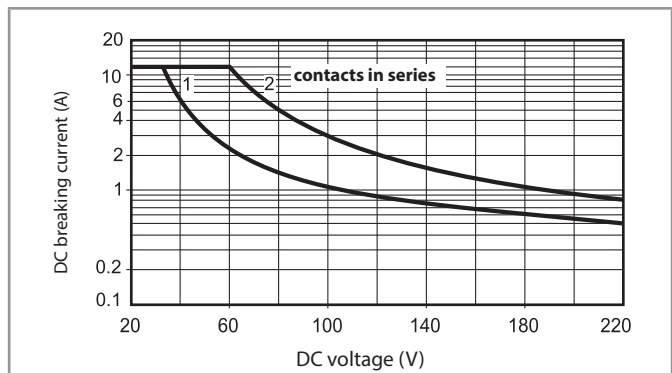

- When switching a resistive load (DC1) having voltage and current values under the curve, an electrical life of  $\geq 100 \cdot 10^3$  can be expected.
- In the case of DC13 loads, the connection of a diode in parallel with the load will permit a similar electrical life as for a DC1 load.

Note: the release time of the load will be increased.



## Coil specifications

### DC coil data, 2 pole relay

Nominal voltage $U_N$	Coil code	Operating range		Resistance $R$	Rated coil consumption $I$ at $U_N$
		$U_{min}$	$U_{max}$		
V		V	V	$\Omega$	mA
6	9.006	4.8	6.6	40	150
12	9.012	9.6	13.2	140	86
24	9.024	19.2	26.4	600	40
48	9.048	38.4	52.8	2400	20
60	9.060	48	66	4000	15
110	9.110	88	121	12500	8.8
125	9.125	100	138	17300	7.2
220	9.220	176	242	54000	4

### DC coil data, 4 pole relay

Nominal voltage $U_N$	Coil code	Operating range		Resistance $R$	Rated coil consumption $I$ at $U_N$
		$U_{min}$	$U_{max}$		
V		V	V	$\Omega$	mA
6	9.006	4.8	6.6	32.5	185
12	9.012	9.6	13.2	123	97
24	9.024	19.2	26.4	490	49
48	9.048	38.4	52.8	1800	27
60	9.060	48	66	3000	20
110	9.110	88	121	10400	10.5
125	9.125	100	138	14200	8.8
220	9.220	176	242	44000	5

### R 56 - DC coil operating range v ambient temperature 2 and 4 pole relay

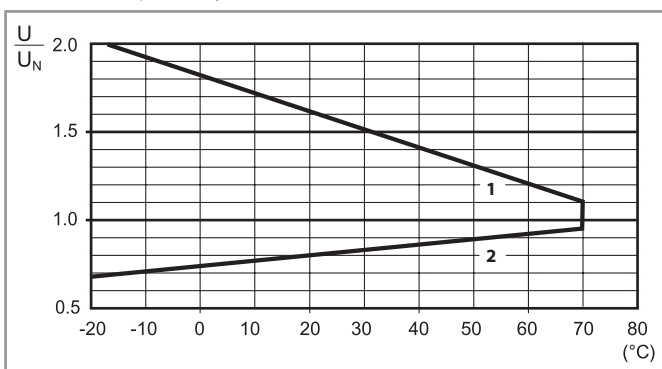

- 1 - Max. permitted coil voltage.
- 2 - Min. pick-up voltage with coil at ambient temperature.

### AC coil data, 2 pole relay

Nominal voltage $U_N$	Coil code	Operating range		Resistance $R$	Rated coil consumption $I$ at $U_N$ (50 Hz)
		$U_{min}^*$	$U_{max}$		
V		V	V	$\Omega$	mA
6	8.006	4.8	6.6	12	200
12	8.012	9.6	13.2	50	97
24	8.024	19.2	26.4	190	53
48	8.048	38.4	52.8	770	25
60	8.060	48	66	1200	21
110	8.110	88	121	3940	12.5
120	8.120	96	132	4700	12
230	8.230	184	253	17000	6
240	8.240	192	264	19100	5.3

\*  $U_{min} = 0.85 U_N$  for normally open version.

### AC coil data, 4 pole relay

Nominal voltage $U_N$	Coil code	Operating range		Resistance $R$	Rated coil consumption $I$ at $U_N$ (50 Hz)
		$U_{min}$	$U_{max}$		
V		V	V	$\Omega$	mA
6	8.006	4.8	6.6	5.7	300
12	8.012	9.6	13.2	22	150
24	8.024	19.2	26.4	81	90
48	8.048	38.4	52.8	380	37
60	8.060	48	66	600	30
110	8.110	88	121	1900	16.5
120	8.120	96	132	2560	13.4
230	8.230	184	253	7700	9
240	8.240	192	264	10000	7.5
400	8.400	320	440	26000	4.9

### R 56 - AC coil operating range v ambient temperature 2 pole relay

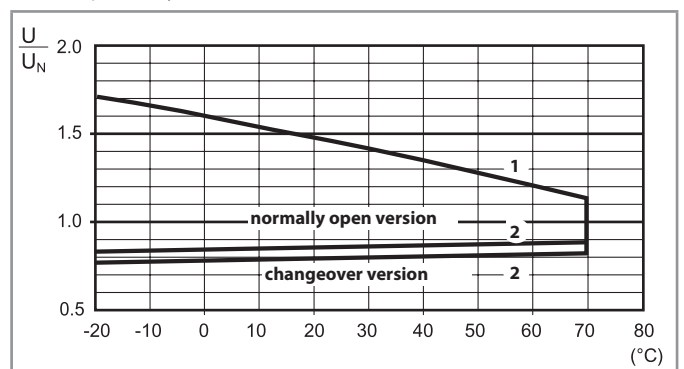

### R 56 - AC coil operating range v ambient temperature 4 pole relay

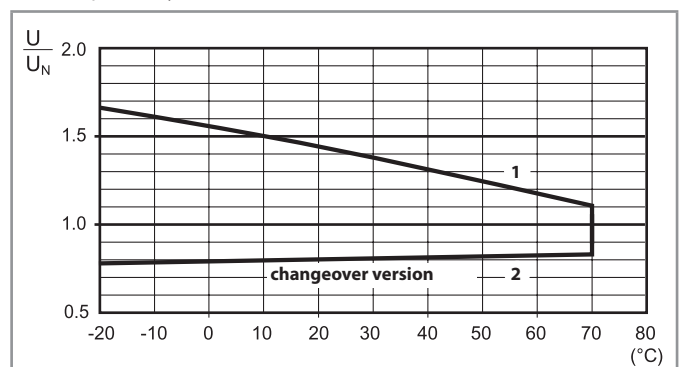

- 1 - Max. permitted coil voltage.
- 2 - Min. pick-up voltage with coil at ambient temperature.

Outline drawings

A

Types 56.32/32-0300

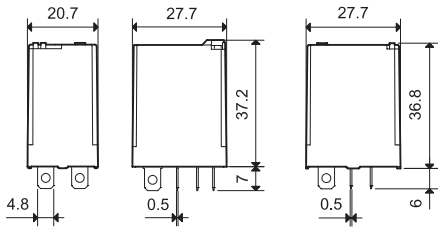

Type 56.34

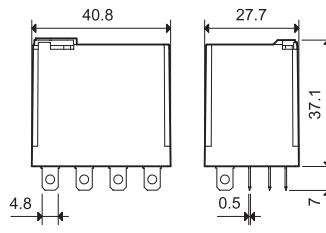

Types 56.42/42-0300

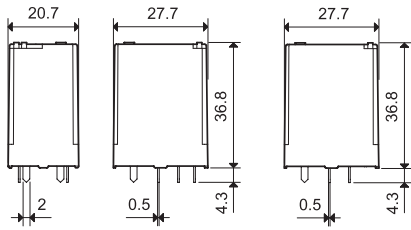

Type 56.44

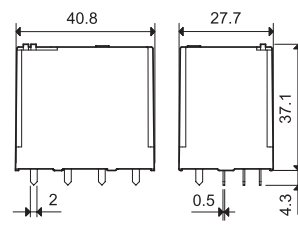

Accessories



**Top flange mount adaptor for 56.32** | 056.25

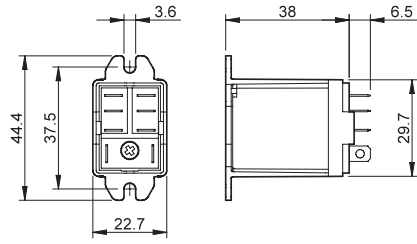

056.25 with relay



**Rear flange mount adaptor for 56.32** | 056.26

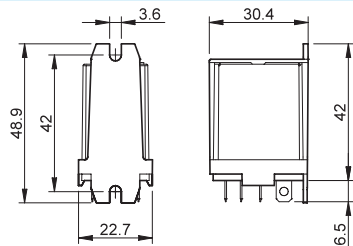

056.26 with relay



**Top 35 mm rail (EN 60715) adaptor for 56.32** | 056.27

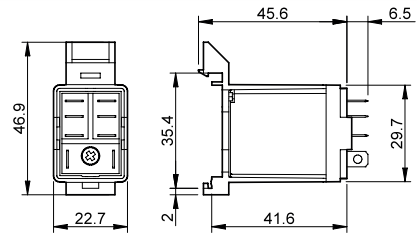

056.27 with relay



**Top flange mount adaptor for 56.34** | 056.45

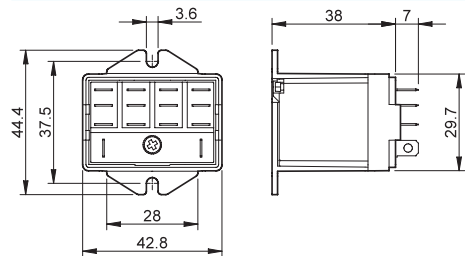

056.45 with relay



**Top 35 mm rail (EN 60715) adaptor for 56.34** | 056.47

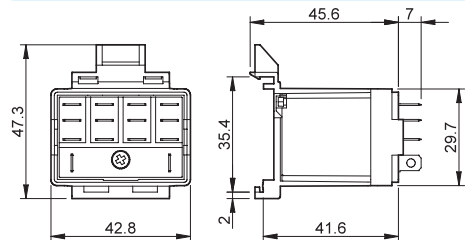

056.47 with relay



**Sheet of marker tags for relay type 56.34, plastic, 48 tags, 6 x 12 mm, for CEMBRE thermal transfer printers** | 060.48

A



**96.02**  
Approvals  
(according to type):



**96.04**  
Approvals  
(according to type):



094.91.3

<b>Screw terminal (Box clamp) socket</b> 35 mm rail mount (EN 60715)	<b>96.02</b> <b>Blue</b>	<b>96.02.0</b> <b>Black</b>	<b>96.04</b> <b>Blue</b>	<b>96.04.0</b> <b>Black</b>
For relay type	56.32		56.34	
<b>Accessories</b>				
Metal retaining clip (supplied with socket - packaging code SMA)	094.71		096.71	
Plastic retaining and release clip (supplied with socket - packaging code SPA)	094.91.3	094.91.30	—	—
6-way jumper link	094.06	094.06.0	—	—
Identification tag	095.00.4		090.00.2	
Modules (see table below)	99.02			
Timer modules (see table below)	86.30		86.00, 86.30	
Sheet of marker tags for retaining and release clip 094.91.3, plastic, 48 tags, 6 x 12 mm, for CEMBRE thermal transfer printers	060.48		—	
<b>Technical data</b>				
Rated values	12 A - 250 V			
Dielectric strength	2 kV AC			
Protection category	IP 20			
Ambient temperature	°C -40...+70 (see diagram L96)			
Screw torque	Nm 0.8			
Wire strip length	mm 8			
Max. wire size for 94.02/04 sockets	solid wire		stranded wire	
	mm <sup>2</sup> 1 x 6 / 2 x 2.5		1 x 4 / 2 x 2.5	
	AWG 1 x 10 / 2 x 14		1 x 12 / 2 x 14	

**L 96 - Rated current v ambient temperature**

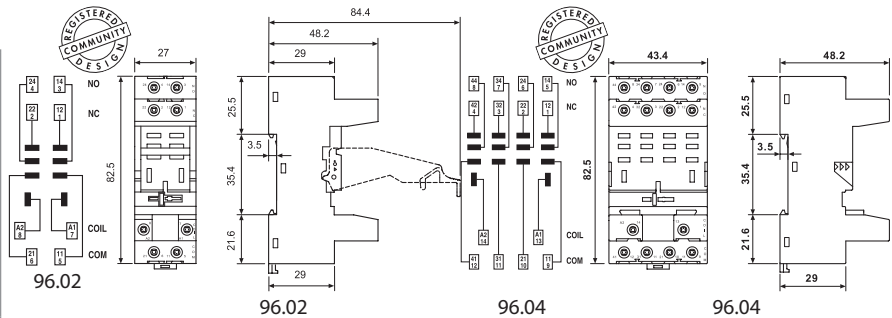
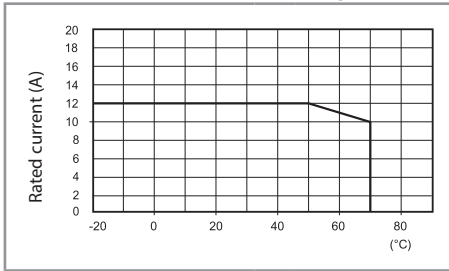

094.06

<b>6-way jumper link for 96.02 socket</b>	094.06 (blue)	094.06.0 (black)
Rated values	10 A - 250 V	

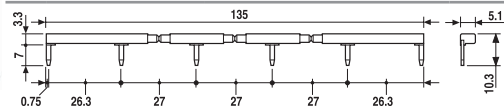

86.00



86.30



99.02

Approvals  
(according to type):



DC Modules with  
non-standard polarity  
(+A2) on request.

<b>86 series timer modules</b>		
Multi-voltage: (12...240)V AC/DC;		
Multi-functions: AI, DI, SW, BE, CE, DE, EE, FE; (0.05 s... 100 h)	86.00.0.240.0000	
(12...24)V AC/DC; Bi-function: AI, DI; (0.05 s... 100 h)	86.30.0.024.0000	
(110...125)V AC; Bi-function: AI, DI; (0.05 s... 100 h)	86.30.8.120.0000	
(230...240)V AC; Bi-function: AI, DI; (0.05 s... 100 h)	86.30.8.240.0000	

Approvals (according to type):

<b>99.02 coil indication and EMC suppression modules for 96.02 and 96.04 sockets</b>		
Diode (+A1, standard polarity)	(6...220)V DC	99.02.3.000.00
LED	(6...24)V DC/AC	99.02.0.024.59
LED	(28...60)V DC/AC	99.02.0.060.59
LED	(110...240)V DC/AC	99.02.0.230.59
LED + Diode (+A1, standard polarity)	(6...24)V DC	99.02.9.024.99
LED + Diode (+A1, standard polarity)	(28...60)V DC	99.02.9.060.99
LED + Diode (+A1, standard polarity)	(110...220)V DC	99.02.9.220.99
LED + Varistor	(6...24)V DC/AC	99.02.0.024.98
LED + Varistor	(28...60)V DC/AC	99.02.0.060.98
LED + Varistor	(110...240)V DC/AC	99.02.0.230.98
RC circuit	(6...24)V DC/AC	99.02.0.024.09
RC circuit	(28...60)V DC/AC	99.02.0.060.09
RC circuit	(110...240)V DC/AC	99.02.0.230.09
Residual current by-pass*	(110...240)V AC	99.02.8.230.07

\* Additional 0.9 W power dissipation

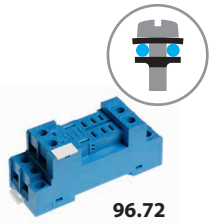

96.72

Approvals  
(according to type):



96.74

Approvals  
(according to type):



Screw terminal (Plate clamp) socket panel or 35 mm rail (EN 60715) mount	96.72 Blue	96.72.0 Black	96.74 Blue	96.74.0 Black
For relay type	56.32		56.34	
<b>Accessories</b>				
Metal retaining clip (supplied with socket - packaging code SMA)	094.71		096.71	
Modules (see table below)	99.01			
<b>Technical data</b>				
Rated values	12 A - 250 V			
Dielectric strength	2 kV AC			
Protection category	IP 20			
Ambient temperature	°C -40...+70			
Screw torque	Nm 0.8			
Wire strip length	mm 10			
Max. wire size for 96.72 and 96.74 sockets	solid wire		stranded wire	
	mm <sup>2</sup> 1 x 4 / 2 x 4		1 x 4 / 2 x 2.5	
	AWG 1 x 12 / 2 x 12		1 x 12 / 2 x 14	

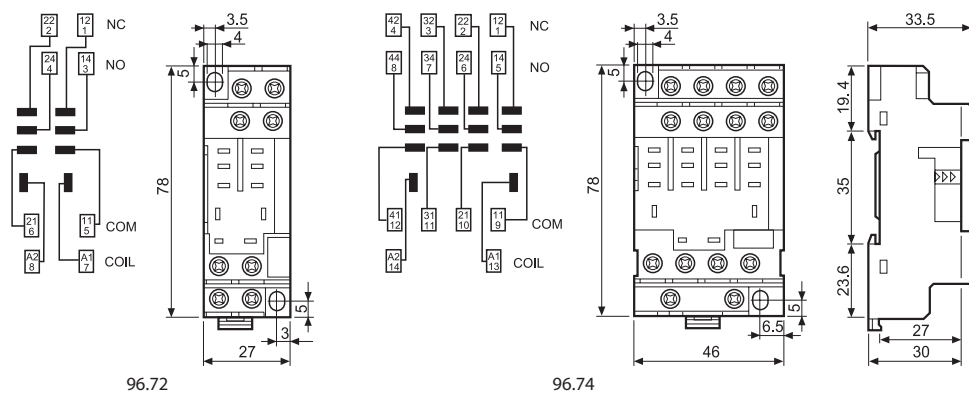

99.01

Approvals  
(according to type):



\* Modules in Black housing are available on request.  
Green LED is standard.  
Red LED available on request.

99.01 coil indication and EMC suppression modules for types 96.72 and 96.74 sockets		Blue*
Diode (+A1, standard polarity)	(6...220)V DC	99.01.3.000.00
Diode (+A2, non-standard polarity)	(6...220)V DC	99.01.2.000.00
LED	(6...24)V DC/AC	99.01.0.024.59
LED	(28...60)V DC/AC	99.01.0.060.59
LED	(110...240)V DC/AC	99.01.0.230.59
LED + Diode (+A1, standard polarity)	(6...24)V DC	99.01.9.024.99
LED + Diode (+A1, standard polarity)	(28...60)V DC	99.01.9.060.99
LED + Diode (+A1, standard polarity)	(110...220)V DC	99.01.9.220.99
LED + Diode (+A2, non-standard polarity)	(6...24)V DC	99.01.9.024.79
LED + Diode (+A2, non-standard polarity)	(28...60)V DC	99.01.9.060.79
LED + Diode (+A2, non-standard polarity)	(110...220)V DC	99.01.9.220.79
LED + Varistor	(6...24)V DC/AC	99.01.0.024.98
LED + Varistor	(28...60)V DC/AC	99.01.0.060.98
LED + Varistor	(110...240)V DC/AC	99.01.0.230.98
RC circuit	(6...24)V DC/AC	99.01.0.024.09
RC circuit	(28...60)V DC/AC	99.01.0.060.09
RC circuit	(110...240)V DC/AC	99.01.0.230.09
Residual current by-pass *	(110...240)V AC	99.01.8.230.07

\* Additional 0.9 W power dissipation



96.12

A

Approvals  
(according to type):



PCB socket	96.12 (blue)	96.12.0 (blue)	96.14 (blue)	96.14.0 (blue)
For relay type	56.32		56.34	
<b>Accessories</b>	094.51			
<b>Technical data</b>				
Rated values	15 A - 250 V			
Dielectric strength	2 kV AC			
Protection category	IP 20			
Ambient temperature	°C -40...+70			

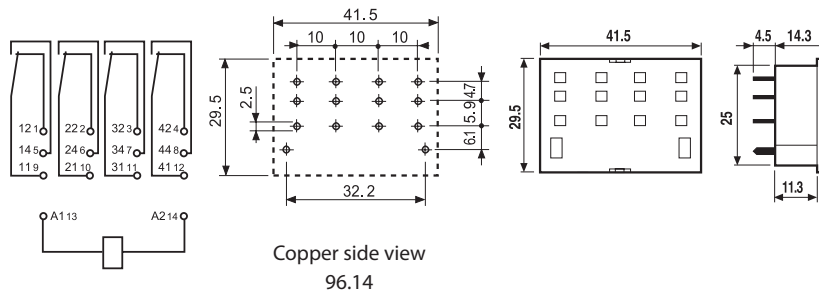
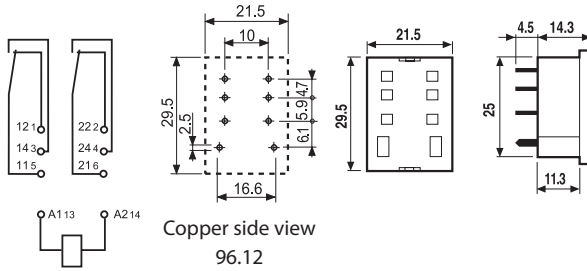

## Packaging codes

How to code and identify retaining clip and packaging options for sockets.

Example:

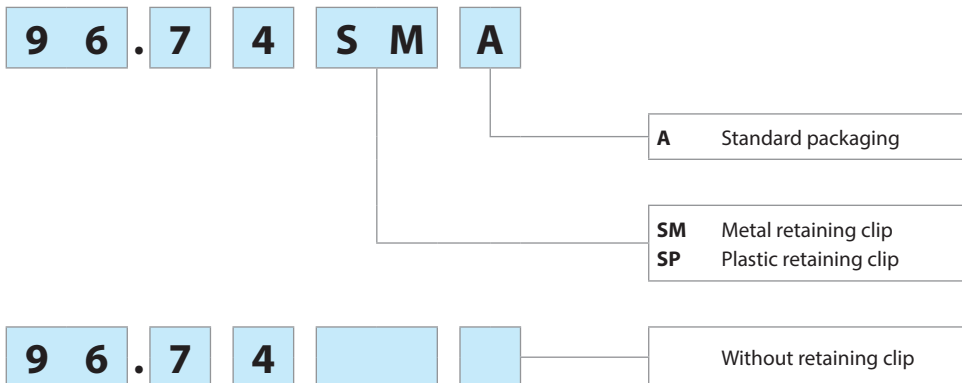

# General purpose relays 6 - 10 A



Shipyards



Hoists and cranes



Road / tunnel  
lighting



Burners,  
boilers and  
furnaces



Wood-processing  
machines



Panels for electrical  
distribution



Control panels



Control systems

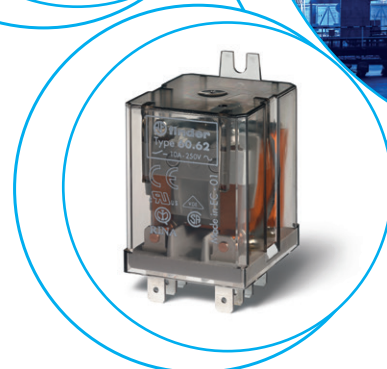
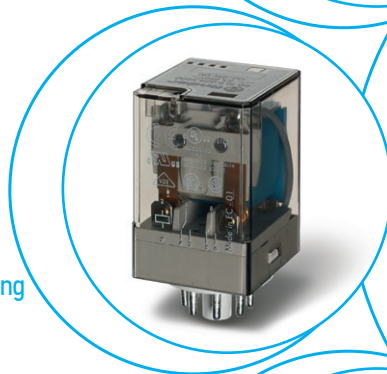
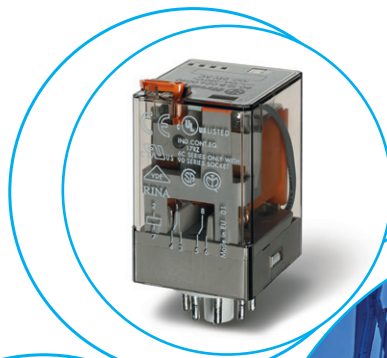





**Plug-in mount**  
**10 A General purpose relay**

**Type 60.12**

- 2 pole, 10 A

**Type 60.13**

- 3 pole, 10 A

- 2 & 3 pole changeover contacts
- Cadmium Free contacts (preferred version)
- AC coils & DC coils
- UL Listing (certain relay/socket combinations)
- Contact material options
- Lockable test button with mechanical flag indicator (preferred version)
- 90 series sockets
- Coil EMC suppression
- Timer accessories 86 series
- European Patent

FOR UL RATINGS SEE:

"General technical information" page V

For outline drawing see page 8

**60.12**



- 2 pole, 10 A
- 8 pin plug-in

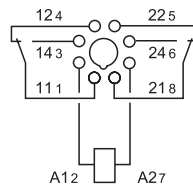

**60.13**



- 3 pole, 10 A
- 11 pin plug-in

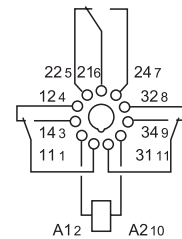

**Contact specification**

Contact configuration		2 CO (DPDT)	3 CO (3PDT)
Rated current/Maximum peak current	A	10/20	10/20
Rated voltage/ Maximum switching voltage	V AC	250/400	250/400
Rated load AC1	VA	2500	2500
Rated load AC15 (230 V AC)	VA	500	500
Single phase motor rating (230 V AC)	kW	0.37	0.37
Breaking capacity DC1: 24/110/220 V	A	10/0.4/0.15	10/0.4/0.15
Minimum switching load	mW (V/mA)	500 (10/5)	500 (10/5)
Standard contact material		AgNi	AgNi

**Coil specification**

Nominal voltage (U <sub>N</sub> )	V AC (50/60 Hz)	6 - 12 - 24 - 48 - 60 - 110 - 120 - 230 - 240 - 400
	V DC	6 - 12 - 24 - 48 - 60 - 110 - 125 - 220
Rated power AC/DC	VA (50 Hz)/W	2.2/1.3
Operating range	AC	(0.8...1.1)U <sub>N</sub>
	DC	(0.8...1.1)U <sub>N</sub>
Holding voltage	AC/DC	0.8 U <sub>N</sub> / 0.5 U <sub>N</sub>
Must drop-out voltage	AC/DC	0.2 U <sub>N</sub> / 0.1 U <sub>N</sub>

**Technical data**

Mechanical life AC/DC	cycles	20 · 10 <sup>6</sup> / 50 · 10 <sup>6</sup>	20 · 10 <sup>6</sup> / 50 · 10 <sup>6</sup>
Electrical life at rated load AC1	cycles	200 · 10 <sup>3</sup>	200 · 10 <sup>3</sup>
Operate/release time	ms	11/4	11/4
Insulation between coil and contacts (1.2/50 μs)	kV	4	3.6
Dielectric strength between open contacts	V AC	1000	1000
Ambient temperature range	°C	-40...+70	-40...+70
Environmental protection		RT I	RT I

**Approvals** (according to type)



**Plug-in mount - 6 A****Bifurcated contacts for low level switching****Type 60.12 - 52xx**

- 2 pole, 6 A

**Type 60.13 - 52xx**

- 3 pole, 6 A

- 2 & 3 pole changeover contacts
- Cadmium Free contacts (Gold plated Silver Nickel)
- AC coils & DC coils
- Lockable test button with mechanical flag indicator (preferred version)
- 90 series sockets
- Coil EMC suppression
- Timer accessories 86 series
- European Patent

**60.12 - 52xx**

- 2 pole, 6 A
- Bifurcated contacts with AgNi + Au
- 8 pin plug-in

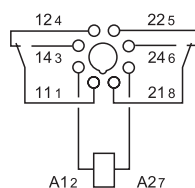
**60.13 - 52xx**

- 3 pole, 6 A
- Bifurcated contacts with AgNi + Au
- 11 pin plug-in

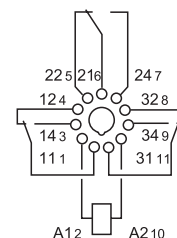

FOR UL RATINGS SEE:

"General technical information" page V

For outline drawing see page 8

**Contact specification**

Contact configuration		2 CO (DPDT)	3 CO (3PDT)
Rated current/Maximum peak current	A	6/10	6/10
Rated voltage/Maximum switching voltage	V AC	250/400	250/400
Rated load AC1	VA	1500	1500
Rated load AC15 (230 V AC)	VA	250	250
Single phase motor rating (230 V AC)	kW	0.185	0.185
Breaking capacity DC1: 24/110/220 V	A	6/0.3/0.12	6/0.3/0.12
Minimum switching load	mW (V/mA)	50 (5/5)	50 (5/5)
Standard contact material		AgNi + Au	AgNi + Au

**Coil specification**

Nominal voltage (U <sub>N</sub> )	V AC (50/60 Hz)	6 - 12 - 24 - 48 - 60 - 110 - 120 - 230 - 240 - 400
	V DC	6 - 12 - 24 - 48 - 60 - 110 - 125 - 220
Rated power AC/DC	VA (50 Hz)/W	2.2/1.3
Operating range	AC	(0.8...1.1)U <sub>N</sub>
	DC	(0.8...1.1)U <sub>N</sub>
Holding voltage	AC/DC	0.8 U <sub>N</sub> / 0.5 U <sub>N</sub>
Must drop-out voltage	AC/DC	0.2 U <sub>N</sub> / 0.1 U <sub>N</sub>

**Technical data**

Mechanical life AC/DC	cycles	20 · 10 <sup>6</sup> / 50 · 10 <sup>6</sup>	20 · 10 <sup>6</sup> / 50 · 10 <sup>6</sup>
Electrical life at rated load AC1	cycles	250 · 10 <sup>3</sup>	250 · 10 <sup>3</sup>
Operate/release time	ms	11/4	11/4
Insulation between coil and contacts (1.2/50 μs)	kV	4	3.6
Dielectric strength between open contacts	V AC	1000	1000
Ambient temperature range	°C	-40...+70	-40...+70
Environmental protection		RT I	RT I

**Approvals** (according to type)

**Flange mount - General purpose relay 10 A**

**Type 60.62**

- 2 pole, 10 A

**Type 60.63**

- 3 pole, 10 A

- Faston 187, (4.8 x 0.8 mm)
- 2 & 3 pole changeover contacts
- AC coils & DC coils
- Cadmium Free contacts
- Contacts material options

**60.62**



- 2 pole, 10 A power contacts
- Flange mount
- Faston 187

**60.63**



- 3 pole, 10 A power contacts
- Flange mount
- Faston 187

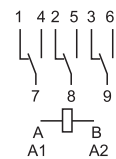
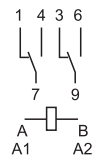

FOR UL RATINGS SEE:

"General technical information" page V

For outline drawing see page 8

**Contact specification**

Contact configuration		2 CO (DPDT)	3 CO (3PDT)
Rated current/Maximum peak current	A	10/20	10/20
Rated voltage/ Maximum switching voltage	V AC	250/400	250/400
Rated load AC1	VA	2500	2500
Rated load AC15 (230 V AC)	VA	500	500
Single phase motor rating (230 V AC)	kW	0.37	0.37
Breaking capacity DC1: 24/110/220 V	A	10/0.4/0.15	10/0.4/0.15
Minimum switching load	mW (V/mA)	500 (10/5)	500 (10/5)
Standard contact material		AgNi	AgNi

**Coil specification**

Nominal voltage (U <sub>N</sub> )	V AC (50/60 Hz)	6 - 12 - 24 - 48 - 60 - 110 - 120 - 230 - 240 - 400	
	V DC	6 - 12 - 24 - 48 - 60 - 110 - 125 - 220	
Rated power AC/DC	VA (50 Hz)/W	2.2/1.3	2.2/1.3
Operating range	AC	(0.8...1.1)U <sub>N</sub>	(0.8...1.1)U <sub>N</sub>
	DC	(0.8...1.1)U <sub>N</sub>	(0.8...1.1)U <sub>N</sub>
Holding voltage	AC/DC	0.8 U <sub>N</sub> / 0.5 U <sub>N</sub>	0.8 U <sub>N</sub> / 0.5 U <sub>N</sub>
Must drop-out voltage	AC/DC	0.2 U <sub>N</sub> / 0.1 U <sub>N</sub>	0.2 U <sub>N</sub> / 0.1 U <sub>N</sub>

**Technical data**

Mechanical life AC/DC	cycles	20 · 10 <sup>6</sup> / 50 · 10 <sup>6</sup>	20 · 10 <sup>6</sup> / 50 · 10 <sup>6</sup>
Electrical life at rated load AC1	cycles	200 · 10 <sup>3</sup>	200 · 10 <sup>3</sup>
Operate/release time	ms	11/4	11/4
Insulation between coil and contacts (1.2/50 μs)	kV	4	3.6
Dielectric strength between open contacts	V AC	1000	1000
Ambient temperature range	°C	-40...+70	-40...+70
Environmental protection		RT I	RT I

**Approvals** (according to type)



### Ordering information

Example: 60 series plug-in relay, 3 CO (3PDT), 12 V DC coil, test button and mechanical indicator.

A

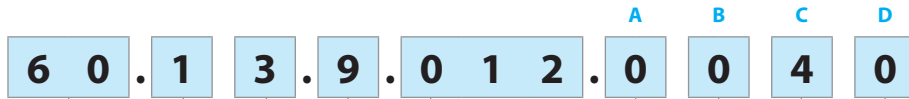

**Series** ————  
**Type** ————  
 1 = 8/11 pin plug-in  
 6 = Faston 187 (4.8 x 0.8 mm) with flange mount  
**No. of poles** ————  
 2 = 2 pole  
 3 = 3 pole  
**Coil version** ————  
 4 = Current sensing (60.12/13 only)  
 8 = AC (50/60 Hz)  
 9 = DC  
**Coil voltage** ————  
 See coil specifications

**A: Contact material**  
 0 = Standard  
 5 = AgNi + Au  
**B: Contact circuit**  
 0 = CO (nPDT)  
 2 = Bifurcated contacts  
 60.12/13 - 6 A only

**D: Special versions**  
 0 = Standard  
**C: Options**  
 0 = None  
 2 = Mechanical indicator  
 3 = LED (AC)  
 4 = Lockable test button + mechanical indicator  
 5\* = Lockable test button + LED (AC)  
 54\* = Lockable test button + LED (AC) + mechanical indicator  
 6\* = LED + diode (DC, polarity positive to pin 2)  
 7\* = Lockable test button + LED + diode (DC, polarity positive to pin 2)  
 74\* = Lockable test button + LED + diode (DC, polarity positive to pin 2) + mechanical indicator  
 \* Options not available for 220 V DC and 400 V AC versions.

**Selecting features and options: only combinations in the same row are possible.**  
 Preferred selections for best availability are shown in **bold**.

Type	Coil version	A	B	C	D
60.12/13	AC	<b>0</b>	<b>0</b>	0 - 2 - 3 - <b>4</b> - 5	<b>0</b>
	AC	0	0	54	/
	AC	5	0 - 2	0 - 2 - 3 - 4 - 5	0
	AC	5	0 - 2	54	/
	DC	<b>0</b>	<b>0</b>	0 - 2 - <b>4</b> - 6 - 7	<b>0</b>
	DC	0	0	74	/
	DC	5	0 - 2	0 - 2 - 4 - 6 - 7	0
	DC	5	0 - 2	74	/
	current sensing	0	0	4	0
60.62/63	AC-DC	<b>0 - 5</b>	<b>0</b>	<b>0</b>	<b>0</b>

#### Descriptions: Options and Special versions

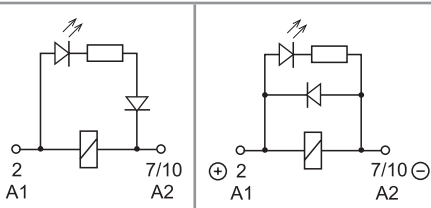

**C: Option 3, 5, 54**  
 LED (AC)  
**C: Option 6, 7, 74**  
 LED + diode (DC, polarity positive to pin 2)

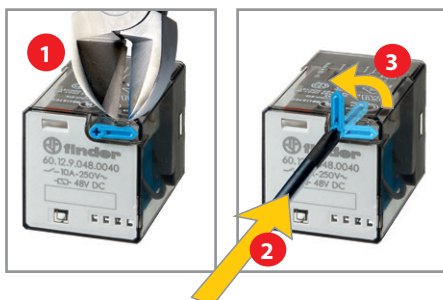

#### Lockable test button and mechanical flag indicator (0040, 0050, 0054, 0070, 0074)

The dual-purpose Finder test button can be used in two ways:

**Case 1)** The plastic pip (located directly above the test button) remains intact. In this case, when the test button is pushed, the contacts operate. When the test button is released the contacts return to their former state.

**Case 2)** The plastic pip is broken-off (using an appropriate cutting tool). In this case, (in addition to the above function), when the test button is pushed and rotated, the contacts are latched in the operating state, and remain so until the test button is rotated back to its former position.

In both cases ensure that the test button actuation is swift and decisive.



## Technical data

Insulation according to EN 61810-1		2 pole		3 pole	
Nominal voltage of supply system	V AC	230/400		230/400	
Rated insulation voltage	V AC	250	400	250	400
Pollution degree		3	2	3	2
<b>Insulation between coil and contact set</b>					
Type of insulation		Basic		Basic	
Overvoltage category		III		III	
Rated impulse voltage	kV (1.2/50 μs)	4		3.6	
Dielectric strength	V AC	2000		2000	
<b>Insulation between adjacent contacts</b>					
Type of insulation		Basic		Basic	
Overvoltage category		III		III	
Rated impulse voltage	kV (1.2/50 μs)	4		3.6	
Dielectric strength	V AC	2000		2000	
<b>Insulation between open contacts</b>					
Type of disconnection		Micro-disconnection		Micro-disconnection	
Dielectric strength	V AC/kV (1.2/50 μs)	1000/1.5		1000/1.5	
<b>Insulation between coil terminals</b>					
Rated impulse voltage (surge) differential mode (according to EN 61000-4-5)	kV (1.2/50 μs)	4			
<b>Other data</b>					
Bounce time: NO/NC	ms	1/4			
Vibration resistance (5...55)Hz: NO/NC	g	22/22			
Shock resistance	g	20			
Power lost to the environment	without contact current	W	1.3		1.3
	with rated current	W	2.7 (60.12, 60.62)		3.4 (60.13, 60.63)

## Contact specification

F 60 -Electrical life (AC) v contact current

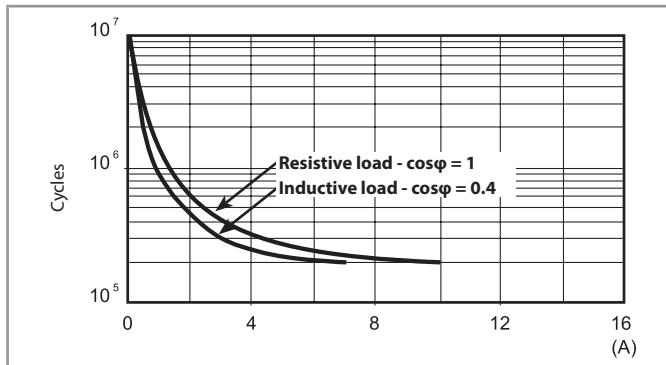

H 60 -Maximum DC1 breaking capacity

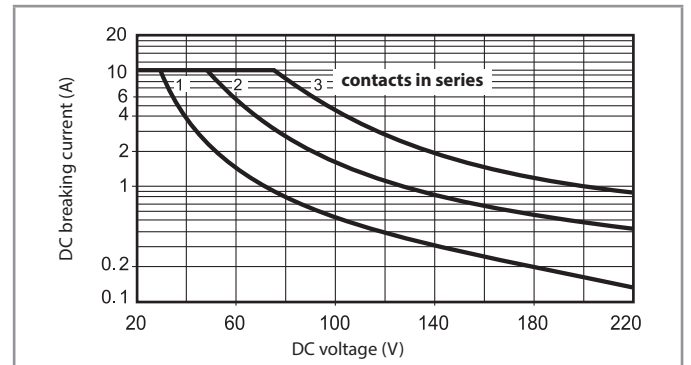

- When switching a resistive load (DC1) having voltage and current values under the curve, an electrical life of  $\geq 100 \cdot 10^3$  can be expected.
  - In the case of DC13 loads, the connection of a diode in parallel with the load will permit a similar electrical life as for a DC1 load.
- Note: the release time for the load will be increased.

## Coil specifications

### DC coil data

Nominal voltage $U_N$ V	Coil code	Operating range		Resistance R $\Omega$	Rated coil absorption I at $U_N$ mA
		$U_{min}$ V	$U_{max}$ V		
6	9.006	4.8	6.6	28	214
12	9.012	9.6	13.2	110	109
24	9.024	19.2	26.4	445	53.9
48	9.048	38.4	52.8	1770	27.1
60	9.060	48	66	2760	21.7
110	9.110	88	121	9420	11.7
125	9.125	100	138	12000	10.4
220	9.220	176	242	37300	5.8

### AC coil data

Nominal voltage $U_N$ V	Coil code	Operating range		Resistance R $\Omega$	Rated coil absorption I at $U_N$ (50 Hz) mA
		$U_{min}$ V	$U_{max}$ V		
6	8.006	4.8	6.6	4.6	367
12	8.012	9.6	13.2	19	183
24	8.024	19.2	26.4	74	90
48	8.048	38.4	52.8	290	47
60	8.060	48	66	450	37
110	8.110	88	121	1600	20
120	8.120	96	132	1940	18.6
230	8.230	184	253	7250	10.5
240	8.240	192	264	8500	9.2
400	8.400	320	440	19800	6

### Coil specifications

R 60 - DC coil operating range v ambient temperature

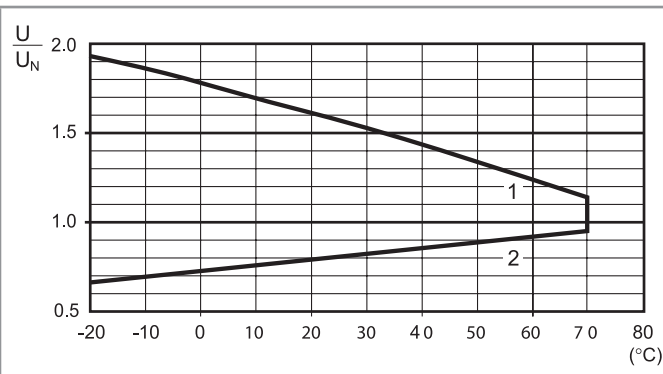

1 - Max. permitted coil voltage.  
2 - Min. pick-up voltage with coil at ambient temperature.

R 60 - AC coil operating range v ambient temperature

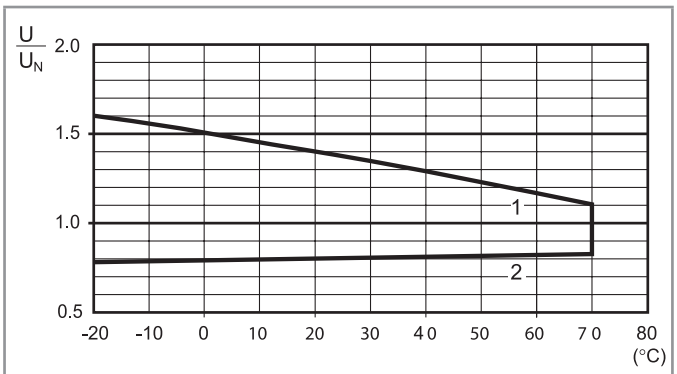

1 - Max. permitted coil voltage.  
2 - Min. pick-up voltage with coil at ambient temperature.

### Current sensing version

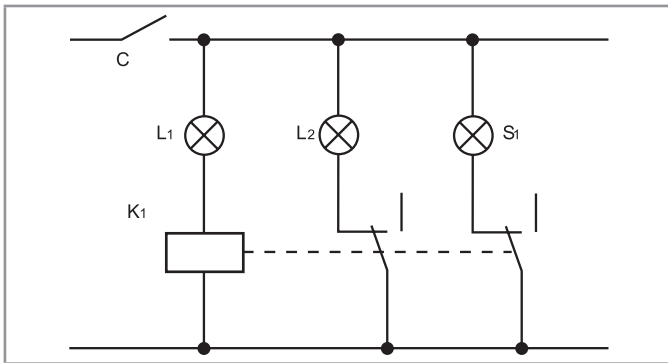

Typical application with current sensing relays.  
An open circuit filament of lamp  $L_1$  is detected by the current sensing relay coil ( $K_1$ ) which causes the back-up safety lamp  $L_2$  to be energised, and indication of failure at the control panel via lamp  $S_1$ .  
Example: navigation light.  
 $L_1$  = Light  
 $L_2$  = Safety light  
 $S_1$  = Control light  
 $K_1$  = Relay

Current sensing DC coil data

Coil code	$I_{min}$ (A)	$I_N$ (A)	$I_{max}$ (A)	R ( $\Omega$ )
4202	1.7	2.0	2.4	0.15
4182	1.5	1.8	2.2	0.19
4162	1.4	1.6	1.9	0.24
4142	1.2	1.4	1.7	0.31
4122	1.0	1.2	1.4	0.42
4102	0.85	1.0	1.2	0.61
4092	0.8	0.9	1.1	0.75
4062	0.5	0.6	0.7	1.70
4032	0.25	0.3	0.4	6.70
4012	0.085	0.1	0.15	61

Current sensing AC coil data

Coil code	$I_{min}$ (A)	$I_N$ (A)	$I_{max}$ (A)	R ( $\Omega$ )
4251	2.1	2.5	3.0	0.05
4181	1.5	1.8	2.2	0.10
4161	1.4	1.6	1.9	0.12
4121	1.0	1.2	1.4	0.22
4101	0.85	1.0	1.2	0.32
4051	0.42	0.5	0.6	1.28
4041	0.34	0.4	0.5	2.00
4031	0.25	0.3	0.4	3.57
4021	0.17	0.2	0.25	8.0
4011	0.085	0.1	0.15	32.1

Other types of current sensing relays are available on request.

### Outline drawings

Type 60.12/60.12 - 52xx

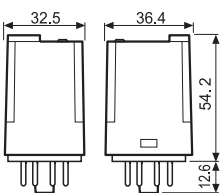

Type 60.13/60.13 - 52xx

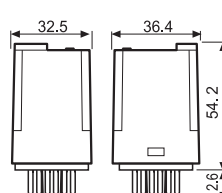

Type 60.62

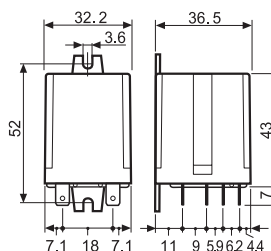

Type 60.63

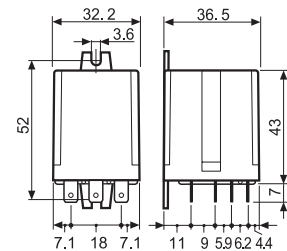

Accessories

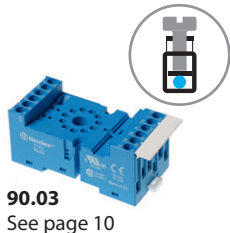

90.03  
See page 10

Module	Socket	Relay	Description	Mounting	Accessories
99.02	90.02	60.12	Screw terminal (Box clamp) socket Double A1 terminal	Panel or 35 mm rail (EN 60715) mount	- Coil indication and EMC suppression modules - Jumper link - Timer modules - Metal retaining clip
	90.03	60.13			

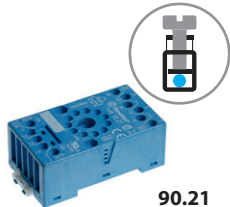

90.21  
See page 11

Module	Socket	Relay	Description	Mounting	Accessories
99.01	90.20	60.12	Screw terminal (Box clamp) socket	Panel or 35 mm rail (EN 60715) mount	- Coil indication and EMC suppression modules - Metal retaining clip
	90.21	60.13			

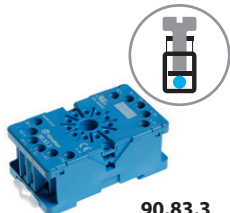

90.83.3  
See page 12

Module	Socket	Relay	Description	Mounting	Accessories
—	90.82.3	60.12	Screw terminal (Box clamp) socket	Panel or 35 mm rail (EN 60715) mount	- Metal retaining clip
—	90.83.3	60.13			



90.23  
See page 12

Module	Socket	Relay	Description	Mounting	Accessories
—	90.22	60.12	Screw terminal (Box clamp) socket	Panel or 35 mm rail (EN 60715) mount	- Metal retaining clip
—	90.23	60.13			

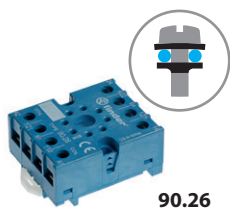

90.26  
See page 13

Module	Socket	Relay	Description	Mounting	Accessories
—	90.26	60.12	Screw terminal (Plate clamp) socket	Panel or 35 mm rail (EN 60715) mount	- Metal retaining clip
—	90.27	60.13			



90.15  
See page 13

Module	Socket	Relay	Description	Mounting	Accessories
—	90.14	60.12	PCB socket	PCB	—
—	90.14.1	60.12			
—	90.15	60.13			
—	90.15.1	60.13			

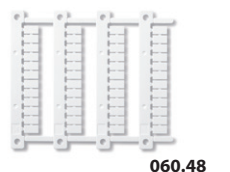

060.48

Sheet of marker tags (CEMBRE Thermal transfer printers) for relay types 60.12 and 60.13, plastic, 48 tags, 6 x 12 mm 060.48



A

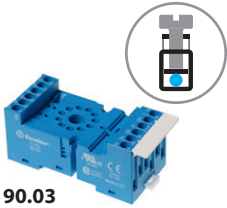

90.03

Approvals  
(according to type):



UL US Certain relay/socket combinations

<b>Screw terminal (Box clamp) socket</b> panel or 35 mm rail (EN 60715) mount	<b>90.02</b> <b>Blue</b>	<b>90.03</b> <b>Blue</b>	
For relay type	60.12	60.13	
<b>Accessories</b>			
Metal retaining clip		090.33	
6-way jumper link		090.06	
Identification tag		090.00.2	
Modules (see table below)		99.02	
Timer modules (see table below)		86.00, 86.30	
<b>Technical data</b>			
Rated values	10 A - 250 V		
Dielectric strength	2 kV AC		
Protection category	IP 20		
Ambient temperature	°C -40...+70		
Screw torque	Nm	0.6	
Wire strip length	mm	10	
Max. wire size for 90.02 and 90.03 sockets	solid wire	stranded wire	
	mm <sup>2</sup>	1 x 6 / 2 x 2.5	1 x 4 / 2 x 2.5
	AWG	1 x 10 / 2 x 14	1 x 12 / 2 x 14

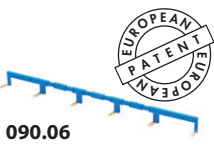
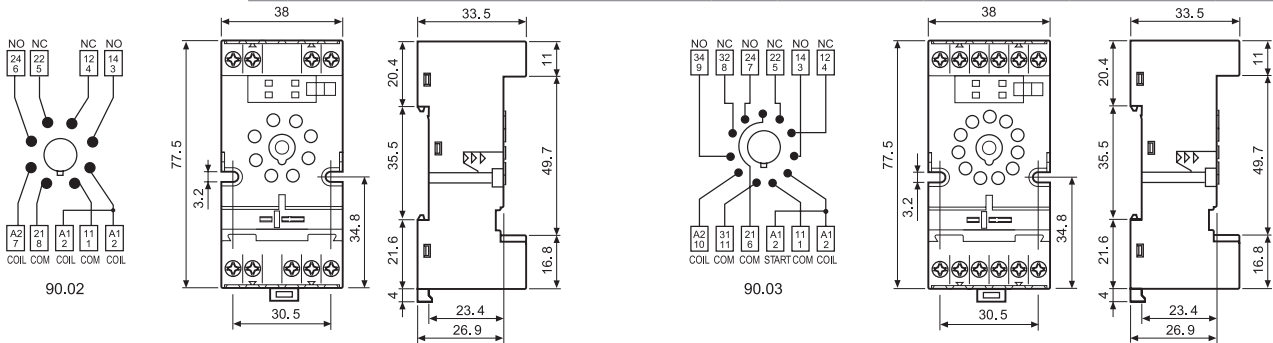

090.06

<b>6-way jumper link</b> for 90.02 and 90.03 sockets	090.06 (blue)	090.06.0 (black)
Rated values	10 A - 250 V	

Approvals  
(according to type):

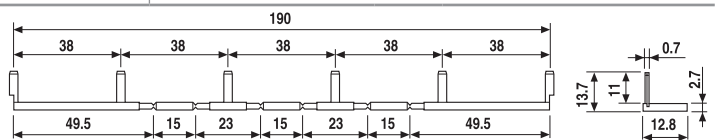

86.00



86.30



99.02

Approvals  
(according to type):



DC Modules with non-standard polarity (+A2) on request.

<b>86 series timer modules</b>		
Multi-voltage: (12...240)V AC/DC;		
Multi-functions: AI, DI, SW, BE, CE, DE, EE, FE; (0.05 s... 100 h)		86.00.0.240.0000
(12...24)V AC/DC; Bi-function: AI, DI; (0.05 s... 100 h)		86.30.0.024.0000
(110...125)V AC; Bi-function: AI, DI; (0.05 s... 100 h)		86.30.8.120.0000
(230...240)V AC; Bi-function: AI, DI; (0.05 s... 100 h)		86.30.8.240.0000

Approvals (according to type):

<b>99.02 coil indication and EMC suppression modules</b> for 90.02 and 90.03 sockets		
Diode (+A1, standard polarity)	(6...220)V DC	99.02.3.000.00
LED	(6...24)V DC/AC	99.02.0.024.59
LED	(28...60)V DC/AC	99.02.0.060.59
LED	(110...240)V DC/AC	99.02.0.230.59
LED + Diode (+A1, standard polarity)	(6...24)V DC	99.02.9.024.99
LED + Diode (+A1, standard polarity)	(28...60)V DC	99.02.9.060.99
LED + Diode (+A1, standard polarity)	(110...220)V DC	99.02.9.220.99
LED + Varistor	(6...24)V DC/AC	99.02.0.024.98
LED + Varistor	(28...60)V DC/AC	99.02.0.060.98
LED + Varistor	(110...240)V DC/AC	99.02.0.230.98
RC circuit	(6...24)V DC/AC	99.02.0.024.09
RC circuit	(28...60)V DC/AC	99.02.0.060.09
RC circuit	(110...240)V DC/AC	99.02.0.230.09
Residual current by-pass*	(110...240)V AC	99.02.8.230.07

\* Additional 0.9 W power dissipation



A

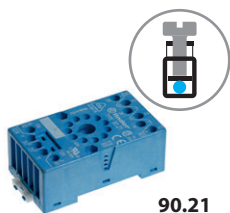

90.21

Approvals  
(according to type):



<b>Screw terminal (Box clamp) socket</b> panel or 35 mm rail (EN 60715) mount	<b>90.20</b> <b>Blue</b>	<b>90.21</b> <b>Blue</b>
For relay type	60.12	60.13
<b>Accessories</b>		
Metal retaining clip (supplied with socket - packaging code SMA)		090.33
Modules (see table below)		99.01
<b>Technical data</b>		
Rated values	10 A - 250 V	
Dielectric strength	2 kV AC	
Protection category	IP 20	
Ambient temperature	°C -40...+70	
Screw torque	Nm	0.5
Wire strip length	mm	10
Max. wire size for 90.20 and 90.21 sockets	solid wire	stranded wire
	mm <sup>2</sup>	1 x 6 / 2 x 2.5
	AWG	1 x 10 / 2 x 14

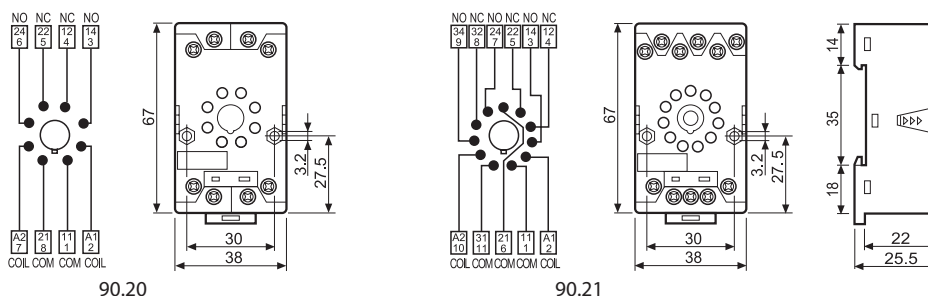

99.01

Approvals  
(according to type):



\* Modules in Black housing are available on request.

Green LED is standard.  
Red LED available on request.

99.01 coil indication and EMC suppression modules for 90.20 and 90.21 sockets		Blue*
Diode (+A1, standard polarity)	(6...220)V DC	99.01.3.000.00
Diode (+A2, non-standard polarity)	(6...220)V DC	99.01.2.000.00
LED	(6...24)V DC/AC	99.01.0.024.59
LED	(28...60)V DC/AC	99.01.0.060.59
LED	(110...240)V DC/AC	99.01.0.230.59
LED + Diode (+A1, standard polarity)	(6...24)V DC	99.01.9.024.99
LED + Diode (+A1, standard polarity)	(28...60)V DC	99.01.9.060.99
LED + Diode (+A1, standard polarity)	(110...220)V DC	99.01.9.220.99
LED + Diode (+A2, non-standard polarity)	(6...24)V DC	99.01.9.024.79
LED + Diode (+A2, non-standard polarity)	(28...60)V DC	99.01.9.060.79
LED + Diode (+A2, non-standard polarity)	(110...220)V DC	99.01.9.220.79
LED + Varistor	(6...24)V DC/AC	99.01.0.024.98
LED + Varistor	(28...60)V DC/AC	99.01.0.060.98
LED + Varistor	(110...240)V DC/AC	99.01.0.230.98
RC circuit	(6...24)V DC/AC	99.01.0.024.09
RC circuit	(28...60)V DC/AC	99.01.0.060.09
RC circuit	(110...240)V DC/AC	99.01.0.230.09
Residual current by-pass *	(110...240)V AC	99.01.8.230.07

\* Additional 0.9 W power dissipation

A

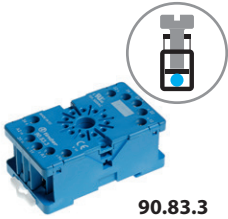

90.83.3

Approvals  
(according to type):



<b>Screw terminal (Box clamp) socket</b> panel or 35 mm rail (EN 60715) mount	<b>90.82.3</b> <b>Blue</b>	<b>90.83.3</b> <b>Blue</b>
For relay type	60.12	60.13
<b>Accessories</b>		
Metal retaining clip	090.33	
<b>Technical data</b>		
Rated values	10 A - 250 V	
Dielectric strength	2 kV AC	
Protection category	IP 20	
Ambient temperature	°C -40...+70	
Screw torque	Nm 0.8	
Max. wire size for 90.82.3 and 90.83.3 sockets	solid wire	stranded wire
	mm <sup>2</sup> 1 x 6 / 2 x 4	1 x 6 / 2 x 4
	AWG 1 x 10 / 2 x 14	1 x 10 / 2 x 14

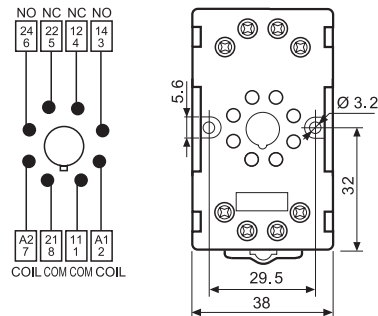

90.82.3

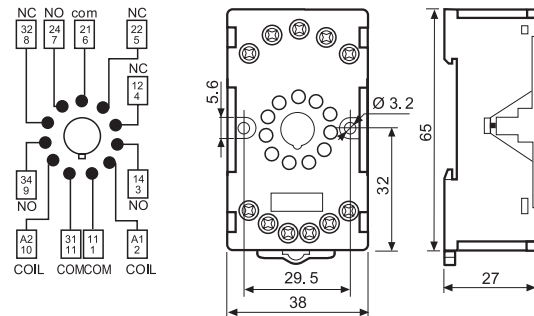

90.83.3



90.23

Approvals  
(according to type):



<b>Screw terminal (Box clamp) socket</b> panel or 35 mm rail (EN 60715) mount	<b>90.22</b> <b>Blue</b>	<b>90.23</b> <b>Blue</b>
For relay type	60.12	60.13
<b>Accessories</b>		
Metal retaining clip (supplied with socket - packaging code SMA)	090.33	
<b>Technical data</b>		
Rated values	10 A - 250 V	
Dielectric strength	2 kV AC	
Protection category	IP 20	
Ambient temperature	°C -40...+70	
Screw torque	Nm 0.5	
Wire strip length	mm 7	
Max. wire size for 90.22 and 90.23 sockets	solid wire	stranded wire
	mm <sup>2</sup> 1 x 6 / 2 x 2.5	1 x 6 / 2 x 2.5
	AWG 1 x 10 / 2 x 14	1 x 10 / 2 x 14

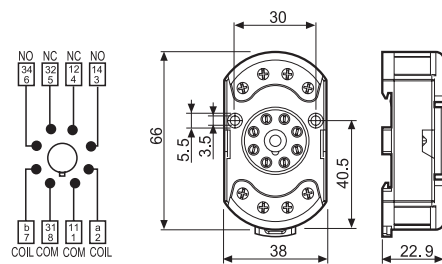

90.22

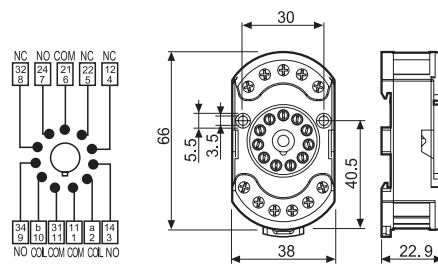

90.23

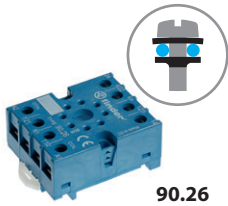

90.26

Approvals  
(according to type):



<b>Screw terminal (Box clamp) socket</b> panel or 35 mm rail (EN 60715) mount	<b>90.26</b> <b>Blue</b>	<b>90.27</b> <b>Blue</b>
For relay type	60.12	60.13
<b>Accessories</b>		
Metal retaining clip (supplied with socket - packaging code SMA)		090.33
<b>Technical data</b>		
Rated values	10 A - 250 V	
Dielectric strength	2 kV AC	
Protection category	IP 20	
Ambient temperature	°C -40...+70	
Screw torque	Nm 0.8	
Wire strip length	mm 10	
Max. wire size for 90.26 and 90.27 sockets	solid wire	stranded wire
	mm <sup>2</sup> 1 x 4 / 2 x 2.5	1 x 4 / 2 x 2.5
	AWG 1 x 12 / 2 x 14	1 x 12 / 2 x 14

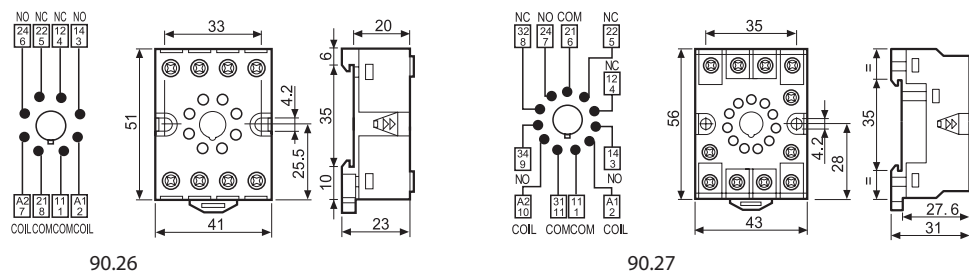

90.15

Approvals  
(according to type):



<b>PCB socket</b>	<b>Blue</b>	<b>90.14 (Ø 20.5 mm)</b>	<b>90.15 (Ø 22 mm)</b>
	<b>Blue</b>	<b>90.14.1 (Ø 17.5 mm)</b>	<b>90.15.1 (Ø 19 mm)</b>
For relay type		60.12	60.13
<b>Technical data</b>			
Rated values	10 A - 250 V		
Dielectric strength	2 kV AC		
Ambient temperature	°C -40...+70		

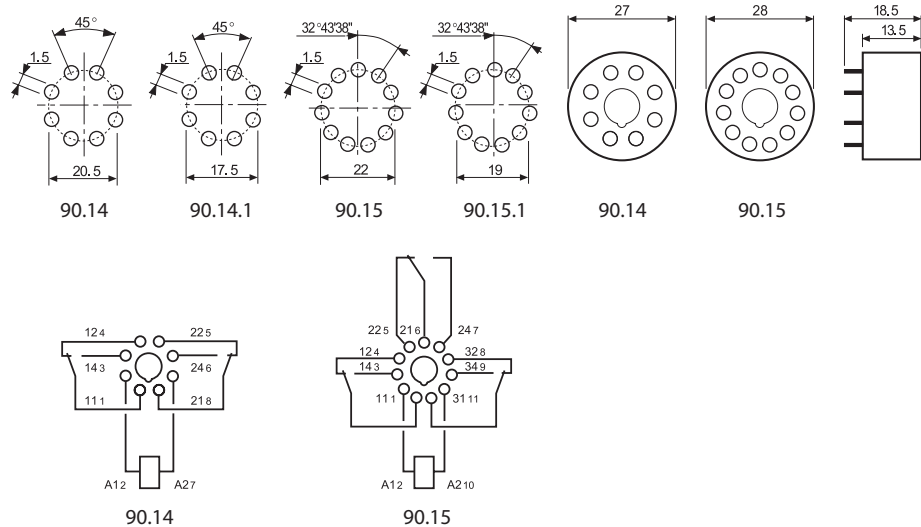

## Packaging codes

How to code and identify retaining clip and packaging options for sockets.

A

Example:

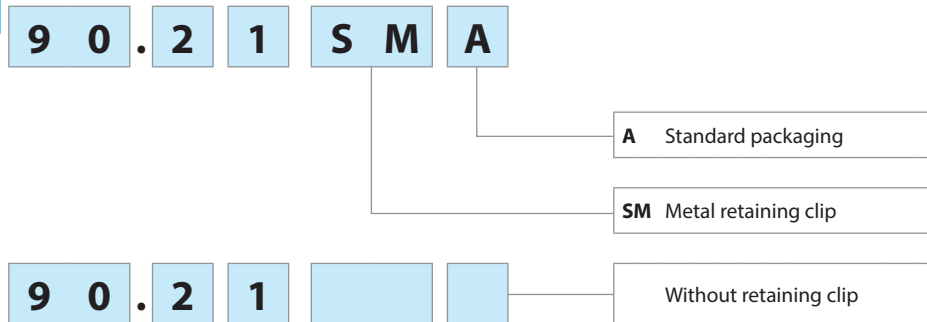

# Power relays 16 A



Road / tunnel lighting



Industrial furnaces and ovens



Burners, boilers and furnaces



Control and management of electric power



Punches, cleaners, planers and sanders



Control panels



Circuit breakers and switches



Industrial motors

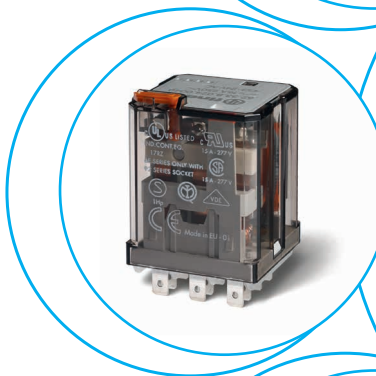



**Printed circuit mount  
16 A Power relay**

- 2 & 3 Pole changeover contacts or NO ( $\geq 3$  mm contact gap)
- AC coils & DC coils
- Reinforced insulation between coil and contacts according to EN 60335-1, with 6 mm clearance & 8 mm creepage distance
- SELV coil-contact separator option

\* Distance between contacts  $\geq 3$  mm (EN 60730-1).  
\*\* Maximum peak current is 120 A - 5 ms (NO contact).

FOR UL RATINGS SEE:  
"General technical information" page V

For outline drawing see page 12

**Contact specification**

Contact configuration	2 CO (DPDT)	3 CO (3PDT)	2 NO (DPST-NO), $\geq 3$ mm*	3 NO (3PST-NO), $\geq 3$ mm*
Rated current/Maximum peak current	A	16/120**	16/120**	
Rated voltage/ Maximum switching voltage	V AC	250/400	250/400	
Rated load AC1	VA	4000	4000	
Rated load AC15 (230 V AC)	VA	750	750	
Motor rating (230/400 V AC)	kW	0.8/—	0.8/1.5	0.8/1.5
Breaking capacity DC1: 24/110/220 V	A	16/0.6/0.4	16/1.1/0.7	
Minimum switching load	mW (V/mA)	1000 (10/10)	1000 (10/10)	
Standard contact material		AgSnO <sub>2</sub>	AgSnO <sub>2</sub>	

**Coil specification**

Nominal voltage (U <sub>N</sub> )	V AC (50/60 Hz)	6 - 12 - 24 - 48 - 60 - 110 - 120 - 230 - 240 - 400		
	V DC	6 - 12 - 24 - 48 - 60 - 110 - 125 - 220		
Rated power AC/DC	VA (50 Hz)/W	2.2/1.3	3/3	
Operating range	AC	(0.8...1.1)U <sub>N</sub>	(0.85...1.1)U <sub>N</sub>	
	DC	(0.8...1.1)U <sub>N</sub>	(0.85...1.1)U <sub>N</sub>	
Holding voltage	AC/DC	0.8 U <sub>N</sub> / 0.6 U <sub>N</sub>	0.8 U <sub>N</sub> / 0.6 U <sub>N</sub>	
Must drop-out voltage	AC/DC	0.2 U <sub>N</sub> / 0.1 U <sub>N</sub>	0.2 U <sub>N</sub> / 0.1 U <sub>N</sub>	

**Technical data**

Mechanical life AC/DC	cycles	10 · 10 <sup>6</sup> /30 · 10 <sup>6</sup>	10 · 10 <sup>6</sup> /30 · 10 <sup>6</sup>	
Electrical life at rated load AC1	cycles	100 · 10 <sup>3</sup>	100 · 10 <sup>3</sup>	
Operate/release time	ms	11/4	15/3	
Insulation between coil and contacts (1.2/50 µs)	kV	6	6	
Dielectric strength between open contacts	V AC	1500	3000	
Ambient temperature range	°C	-40...+70	-40...+50	
Environmental protection		RT I	RT I	

**Approvals** (according to type)



**62.22/62.23**



- 2 & 3 pole changeover contact
- PCB mount

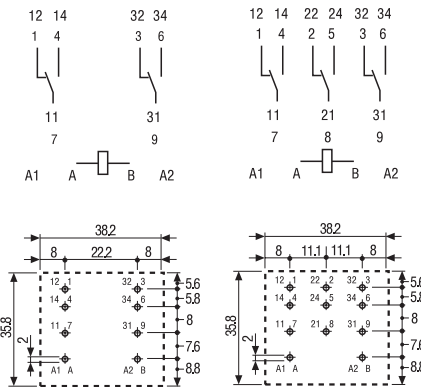

62.22 Copper side view      62.23 Copper side view

**62.22-4300/62.23-4300**



- 2 & 3 pole normally open contact ( $\geq 3$  mm contact gap)
- PCB mount

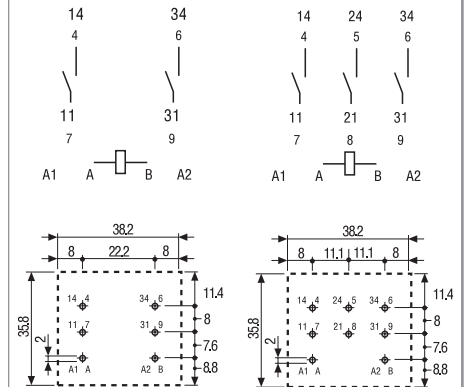

62.22 - 4300 Copper side view      62.23 - 4300 Copper side view

A

**Plug-in mount/Faston 187  
16 A Power relay**

- Plug-in (92 series sockets) or Faston 187 (4.8 x 0.5 mm) with optional mounting adaptors
- 2 & 3 Pole changeover contacts or NO ( $\geq 3$  mm contact gap)
- AC coils & DC coils
- UL Listing (certain relay/socket combinations)
- LED, mechanical indicator & test button options
- Reinforced insulation between coil and contacts according to EN 60335-1, with 6 mm clearance & 8 mm creepage distance
- SELV coil-contact separator option
- Sockets and accessories
- European Patent

\* Distance between contacts  $\geq 3$  mm (EN 60730-1).  
\*\* Maximum peak current is 120 A - 5 ms (NO contact).

FOR UL RATINGS SEE:  
"General technical information" page V

For outline drawing see page 12

**Contact specification**

Contact configuration		2 CO (DPDT)	3 CO (3PDT)	2 NO (DPST-NO), $\geq 3$ mm*	3 NO (3PST-NO), $\geq 3$ mm*
Rated current/Maximum peak current	A	16/120**			16/120**
Rated voltage/ Maximum switching voltage	V AC	250/400			250/400
Rated load AC1	VA	4000			4000
Rated load AC15 (230 V AC)	VA	750			750
Motor rating (230/400 V AC)	kW	0.8/—	0.8/1.5	0.8/—	0.8/1.5
Breaking capacity DC1: 24/110/220 V	A	16/0.6/0.4			16/1.1/0.7
Minimum switching load	mW (V/mA)	1000 (10/10)			1000 (10/10)
Standard contact material		AgSnO <sub>2</sub>			AgSnO <sub>2</sub>

**Coil specification**

Nominal voltage (U <sub>N</sub> )	V AC (50/60 Hz)	6 - 12 - 24 - 48 - 60 - 110 - 120 - 230 - 240 - 400			
	V DC	6 - 12 - 24 - 48 - 60 - 110 - 125 - 220			
Rated power AC/DC	VA (50 Hz)/W	2.2/1.3		3/3	
Operating range	AC	(0.8...1.1)U <sub>N</sub>			(0.85...1.1)U <sub>N</sub>
	DC	(0.8...1.1)U <sub>N</sub>			(0.85...1.1)U <sub>N</sub>
Holding voltage	AC/DC	0.8 U <sub>N</sub> / 0.6 U <sub>N</sub>			0.8 U <sub>N</sub> / 0.6 U <sub>N</sub>
Must drop-out voltage	AC/DC	0.2 U <sub>N</sub> / 0.1 U <sub>N</sub>			0.2 U <sub>N</sub> / 0.1 U <sub>N</sub>

**Technical data**

Mechanical life AC/DC	cycles	10 · 10 <sup>6</sup> /30 · 10 <sup>6</sup>		10 · 10 <sup>6</sup> /30 · 10 <sup>6</sup>	
Electrical life at rated load AC1	cycles	100 · 10 <sup>3</sup>		100 · 10 <sup>3</sup>	
Operate/release time	ms	11/4		15/3	
Insulation between coil and contacts (1.2/50 $\mu$ s)	kV	6		6	
Dielectric strength between open contacts	V AC	1500		3000	
Ambient temperature range	°C	-40...+70		-40...+50	
Environmental protection		RT I		RT I	

**Approvals** (according to type)



**62.32/62.33**



- 2 & 3 pole changeover contact
- Plug-in/Faston 187

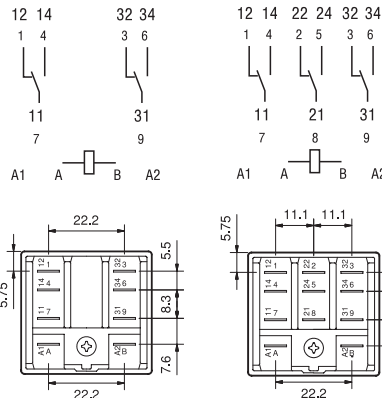

62.32

62.33

**62.32-4300/62.33-4300**



- 2 & 3 pole normally open contact ( $\geq 3$  mm contact gap)
- Plug-in/Faston 187

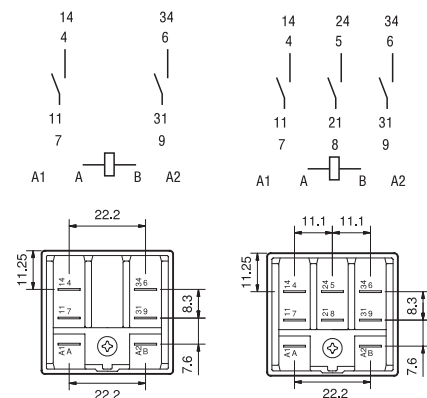

62.32-4300

62.33-4300



**Flange mount/Faston 250  
16 A Power relay**

- Faston 250 (6.3 x 0.8 mm) termination Flange or optional mounting adaptors
- 2 & 3 Pole changeover contacts or NO ( $\geq 3$  mm contact gap)
- AC coils & DC coils
- LED, mechanical indicator & test button options
- Reinforced insulation between coil and contacts according to EN 60335-1, with 6 mm clearance & 8 mm creepage distance
- SELV coil-contact separator option
- European Patent

**62.82/62.83**



- 2 & 3 pole changeover contact
- Flange mount/Faston 250

**62.82-4300/62.83-4300**



- 2 & 3 pole normally open contact ( $\geq 3$  mm contact gap)
- Flange mount/Faston 250

\* Distance between contacts  $\geq 3$  mm (EN 60730-1).  
\*\* Maximum peak current is 120 A - 5 ms (NO contact).

For UL RATINGS SEE:  
"General technical information" page V

For outline drawing see page 12

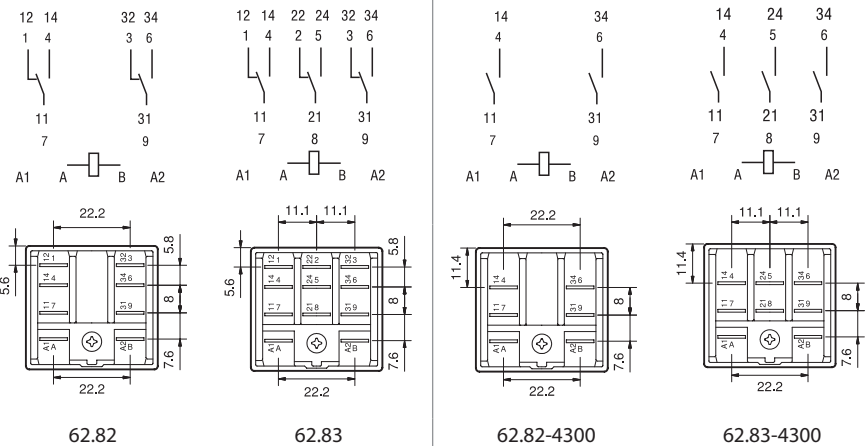

**Contact specification**

Contact configuration		2 CO (DPDT)	3 CO (3PDT)	2 NO (DPST-NO), $\geq 3$ mm*	3 NO (3PST-NO), $\geq 3$ mm*
Rated current/Maximum peak current	A	16/120**		16/120**	
Rated voltage/ Maximum switching voltage	V AC	250/400		250/400	
Rated load AC1	VA	4000		4000	
Rated load AC15 (230 V AC)	VA	750		750	
Motor rating (230/400 V AC)	kW	0.8/—	0.8/1.5	0.8/—	0.8/1.5
Breaking capacity DC1: 24/110/220 V	A	16/0.6/0.4		16/1.1/0.7	
Minimum switching load	mW (V/mA)	1000 (10/10)		1000 (10/10)	
Standard contact material		AgSnO <sub>2</sub>		AgSnO <sub>2</sub>	

**Coil specification**

Nominal voltage (U <sub>N</sub> )	V AC (50/60 Hz)	6 - 12 - 24 - 48 - 60 - 110 - 120 - 230 - 240 - 400			
	V DC	6 - 12 - 24 - 48 - 60 - 110 - 125 - 220			
Rated power AC/DC	VA (50 Hz)/W	2.2/1.3		3/3	
Operating range	AC	(0.8...1.1)U <sub>N</sub>		(0.85...1.1)U <sub>N</sub>	
	DC	(0.8...1.1)U <sub>N</sub>		(0.85...1.1)U <sub>N</sub>	
Holding voltage	AC/DC	0.8 U <sub>N</sub> / 0.6 U <sub>N</sub>		0.8 U <sub>N</sub> / 0.6 U <sub>N</sub>	
Must drop-out voltage	AC/DC	0.2 U <sub>N</sub> / 0.1 U <sub>N</sub>		0.2 U <sub>N</sub> / 0.1 U <sub>N</sub>	

**Technical data**

Mechanical life AC/DC	cycles	10 · 10 <sup>6</sup> /30 · 10 <sup>6</sup>		10 · 10 <sup>6</sup> /30 · 10 <sup>6</sup>	
Electrical life at rated load AC1	cycles	100 · 10 <sup>3</sup>		100 · 10 <sup>3</sup>	
Operate/release time	ms	11/4		15/3	
Insulation between coil and contacts (1.2/50 $\mu$ s)	kV	6		6	
Dielectric strength between open contacts	V AC	1500		3000	
Ambient temperature range	°C	-40...+70		-40...+50	
Environmental protection		RT I		RT I	

**Approvals** (according to type)



A

**Plug-in mount/Faston 187  
Magnetic blow power relay**

- Plug-in (92 series sockets) or Faston 187 (4.8 x 0.5 mm) with optional mounting adaptors
- 1 & 2 Pole NO contacts
- High DC load (resistive and inductive) switching capability
- DC coils
- Reinforced insulation between coil and contacts according to EN 60335-1, with 6 mm clearance & 8 mm creepage distance
- Cadmium free contact material
- Sockets and accessories

**62.31-4800**



- 1 pole normally open contact (double break,  $\geq 4.2$  mm contact gap)
- Plug-in/Faston 187

**62.32-4800**



- 2 pole normally open contact (2 pole normally open contact ( $\geq 2.1$  mm contact gap))
- Plug-in/Faston 187

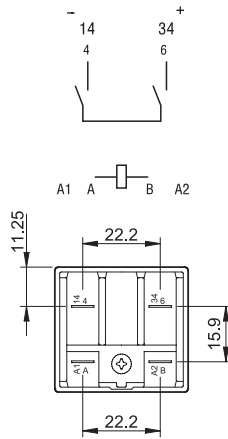

62.31-4800

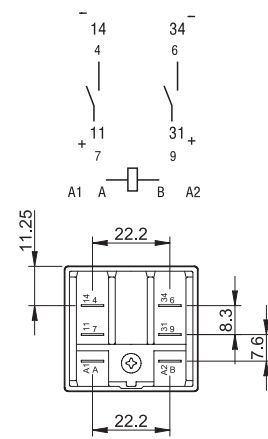

62.32-4800

\* Maximum peak current 120 A - 5 ms.

For outline drawing see page 12

**Contact specification**

Contact configuration		1 NO (SPST-NO) double break, $\geq 4.2$ mm	2 NO (DPST-NO), $\geq 2.1$ mm
Rated current/Maximum peak current	A	16/30*	16/30*
Rated voltage/ Maximum switching voltage	V AC	250/400	250/400
Rated load AC1	VA	4000	4000
Breaking capacity DC1: 24/125/220 V	A	16/16/12	16/12/6
Breaking capacity DC inductive (L/R = 40 ms): 30/125/220 V	A	16/5/3	10/2/1.2
Minimum switching load	mW (V/mA)	1000 (10/10)	1000 (10/10)
Standard contact material		AgSnO <sub>2</sub>	AgSnO <sub>2</sub>

**Coil specification**

Nominal voltage (U <sub>N</sub> )	V DC	6 - 12 - 24 - 48 - 60 - 110 - 125 - 220	
Rated power DC	W	1.3	1.3
Operating range	DC	(0.85...1.1)U <sub>N</sub>	(0.85...1.1)U <sub>N</sub>
Holding voltage	DC	0.6 U <sub>N</sub>	0.6 U <sub>N</sub>
Must drop-out voltage	DC	0.1 U <sub>N</sub>	0.1 U <sub>N</sub>

**Technical data**

Mechanical life DC	cycles	10 · 10 <sup>6</sup>	10 · 10 <sup>6</sup>
Electrical life at rated load DC1	cycles	100 · 10 <sup>3</sup>	100 · 10 <sup>3</sup>
Operate/release time	ms	16/5	16/5
Insulation between coil and contacts (1.2/50 μs)	kV	6	6
Dielectric strength between open contacts	V AC	3000	2000
Ambient temperature range	°C	-40...+70	-40...+70
Environmental protection		RT I	RT I

**Approvals** (according to type)



### Ordering information

Example: 62 series power relay + Faston 250 (6.3 x 0.8 mm), rear flange mount, 2 NO (DPST-NO), 12 V DC coil.

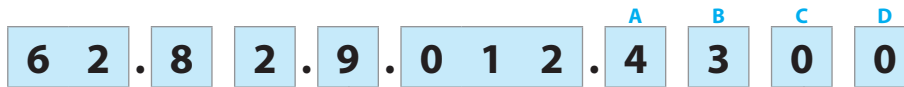

**Series**  
**Type**  
 2 = PCB  
 3 = Plug-in  
 8 = Faston 250 (6.3 x 0.8 mm) with rear flange mount

**No. of poles**  
 1 = 1 pole (double break)  
 2 = 2 pole  
 3 = 3 pole

**Coil version**  
 8 = AC (50/60 Hz)  
 9 = DC

**Coil voltage**  
 See coil specifications

**A: Contact material**  
 4 = AgSnO<sub>2</sub>

**B: Contact circuit**  
 0 = CO (nPDT)  
 3 = NO (nPST), ≥ 3 mm contact gap  
 5 = CO (nPDT) + additional physical separator between coil and contacts (for SELV applications)  
 6 = NO (nPST), ≥ 3 mm contact gap + additional physical separator between coil and contacts (for SELV applications)  
 8 = NO (1 pole double break or 2 pole) with magnetic blow

**D: Special versions**  
 0 = Standard  
 6 = Rear flange mount  
 9 = Type 62.82/83 without rear flange mount

**C: Options**  
 0 = None  
 2 = Mechanical indicator  
 3 = LED (AC)  
 4 = Lockable test button + mechanical indicator  
 5\* = Lockable test button + LED (AC)  
 54\* = Lockable test button + LED (AC) + mechanical indicator  
 6\* = LED + diode (DC, polarity positive to pin A/A1)  
 7\* = Lockable test button + LED + diode (DC, polarity positive to pin A/A1)  
 74\* = Lockable test button + LED + diode (DC, polarity positive to pin A/A1) + mechanical indicator  
 \* Options not available for 220 V DC and 400 V AC versions.

### Selecting features and options: only combinations in the same row are possible.

Preferred selections for best availability are shown in **bold**.

Type	Coil version	A	B	C	D
62.22/23	AC-DC	4	<b>0</b> - 3 - 5 - 6	<b>0</b>	<b>0</b>
62.32/33	AC-DC	4	0 - 3 - 5 - 6	0	0 - 6
	AC-DC	4	<b>0</b> - 5	2 - <b>4</b>	<b>0</b> - 6
	AC	4	<b>0</b>	2 - 3 - <b>4</b> - 5	<b>0</b> - 6
	AC	4	0 - 3	3	0 - 6
	AC	4	0	54	/
	DC	4	<b>0</b>	<b>4</b> - 6 - 7	<b>0</b> - 6
	DC	4	0 - 3	6	0 - 6
	DC	4	0	74	/
62.31/32	DC	4	<b>8</b>	<b>0</b>	<b>0</b>
62.82/83	AC-DC	4	<b>0</b> - 3 - 5 - 6	<b>0</b>	<b>0</b> - 9
	AC-DC	4	0 - 5	2 - 4	0
	AC	4	0	2 - 3 - 4 - 5	0
	AC	4	0 - 3	3	0
	DC	4	0	4 - 6 - 7	0
DC	4	0 - 3	6	0	

### Descriptions: Options and Special versions

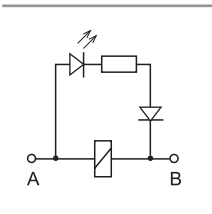

**C: Option 3, 5, 54**  
LED (AC)

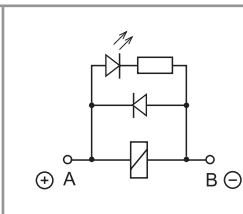

**C: Option 6, 7, 74**  
LED + diode (DC, polarity positive to pin A/A1)

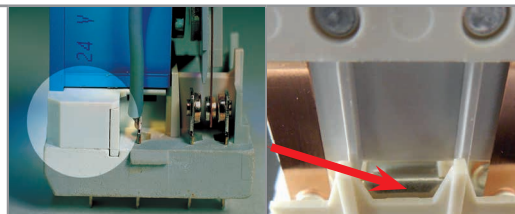

**B: Contact circuit 5, 6**  
Additional physical separator between coil and contacts (for SELV applications)

**B: Contact circuit 8**  
Magnetic blow



### Lockable test button and mechanical flag indicator (0040, 0050, 0054, 0070, 0074)

The dual-purpose Finder test button can be used in two ways:

Case 1) The plastic pip (located directly above the test button) remains intact. In this case, when the test button is pushed, the contacts operate. When the test button is released the contacts return to their former state.

Case 2) The plastic pip is broken-off (using an appropriate cutting tool). In this case, (in addition to the above function), when the test button is pushed and rotated, the contacts are latched in the operating state, and remain so until the test button is rotated back to its former position. In both cases ensure that the test button actuation is swift and decisive.



## Technical data

### Insulation according to EN 61810-1

		2 CO - 3 CO	2 NO - 3 NO	1 NO*	2 NO*			
Nominal voltage of supply system	V AC	230/400	230/400	230/400	230/400			
Rated insulation voltage	V AC	400	400	400	400			
Pollution degree		3	3	3	3			
<b>Insulation between coil and contact set</b>								
Type of insulation		Reinforced	Reinforced	Reinforced	Reinforced			
Overvoltage category		III	III	III	III			
Rated impulse voltage	kV (1.2/50 μs)	6	6	6	6			
Dielectric strength	V AC	4000	4000	4000	4000			
<b>Insulation between adjacent contacts</b>								
Type of insulation		Basic	Basic	—	Basic			
Overvoltage category		III	III	—	III			
Rated impulse voltage	kV (1.2/50 μs)	4	4	—	4			
Dielectric strength	V AC	2500	2500	—	2500			
<b>Insulation between open contacts</b>								
Type of disconnection		Micro-disconnection	Full-disconnection	Full-disconnection	Full-disconnection**			
Overvoltage category		—	III	III	II			
Rated impulse voltage	kV (1.2/50 μs)	—	4	4	2.5			
Dielectric strength	V AC/kV (1.2/50 μs)	1500/2	3000/4	3000/4	2000/2.5			
<b>Insulation between coil terminals</b>								
Rated impulse voltage (surge) differential mode (according to EN 61000-4-5)	kV (1.2/50 μs)	4						
<b>Other data</b>								
Bounce time: NO/NC	ms	1/5 (changeover)	3/— (normally open)	3/— (normally open)	3/— (normally open)			
Vibration resistance (10...150)Hz: NO/NC	g	20/8						
Shock resistance	g	15						
Power lost to the environment		<b>2 pole (CO)</b>	<b>3 pole (CO)</b>	<b>2 pole (NO)</b>	<b>3 pole (NO)</b>	<b>1 pole (NO)*</b>	<b>2 pole (NO)*</b>	
	without contact current	W	1.3	1.3	3	3	1.3	1.3
	with rated current	W	3.3	4.3	5	6	3	3.3
Recommended distance between relays mounted on PCB	mm	≥ 5				—		

\* Magnetic blow version

\*\* Only in applications where over voltage category II is permitted. In applications of over voltage category III: Micro-disconnection.

A

## Contact specification

F 62 - Electrical life (AC) v contact current

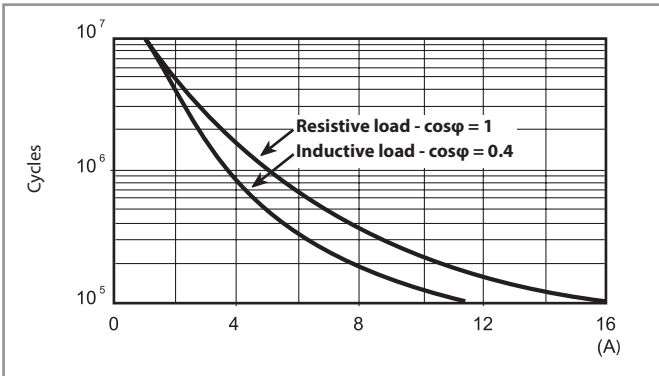

H 62 - Maximum DC1 breaking capacity

Changeover contacts

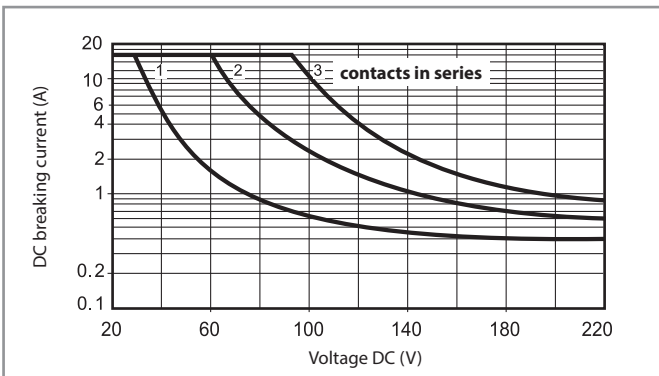

H 62 - Maximum DC1 breaking capacity

Normally open contacts

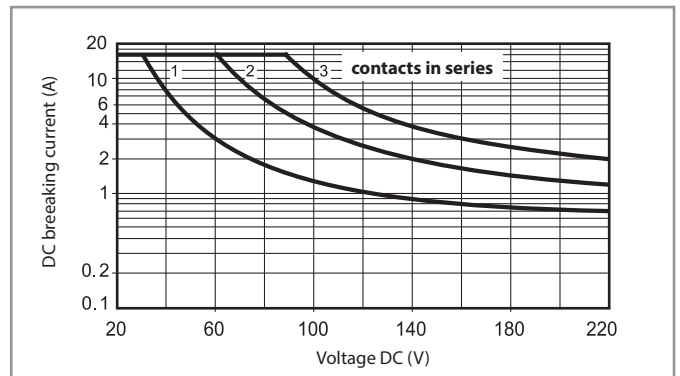

- When switching a resistive load (DC1) having voltage and current values under the curve, an electrical life of  $\geq 100 \cdot 10^3$  can be expected.
- In the case of DC13 loads, the connection of a diode in parallel with the load will permit a similar electrical life as for a DC1 load.  
Note: the release time of the load will be increased.

H 62 - Maximum DC breaking capacity 62.31.9.xxx.4800

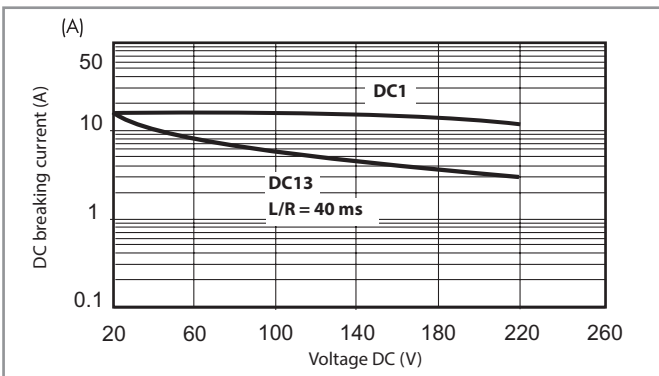

H 62 - Maximum DC breaking capacity 62.32.9.xxx.4800

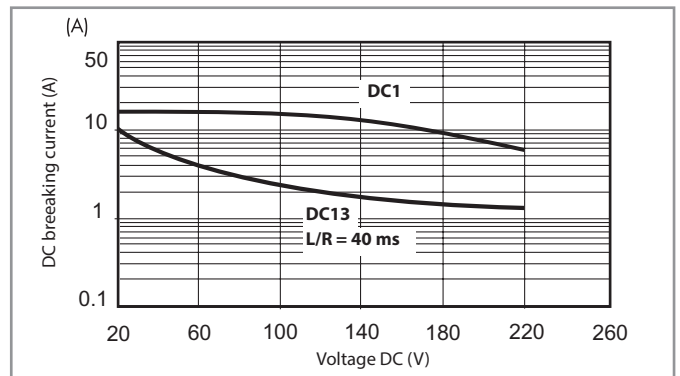

- When switching a resistive load (DC1), or a DC13 load with a diode in parallel to the load, having voltage and current values under the DC1 curve, an electrical life of  $\geq 100 \cdot 10^3$  can be expected. Note: the release time for the load will be increased.
- When switching a DC13 load without a diode in parallel to the load, the DC13 curve applies and an electrical life of  $\geq 80 \cdot 10^3$  can be expected.

## Coil specifications

## DC version data

Nominal voltage $U_N$	Coil code	Operating range		Resistance R	Rated coil consumption I at $U_N$
		$U_{min}$	$U_{max}$		
V		V	V	$\Omega$	mA
6	9.006	4.8	6.6	28	214
12	9.012	9.6	13.2	110	109
24	9.024	19.2	26.4	445	54
48	9.048	38.4	52.8	1770	27
60	9.060	48	66	2760	21.7
110	9.110	88	121	9420	11.7
125	9.125	100	138	12000	10.4
220	9.220	176	242	37300	5.8

## AC version data

Nominal voltage $U_N$	Coil code	Operating range		Resistance R	Rated coil consumption I at $U_N$ (50Hz)
		$U_{min}$	$U_{max}$		
V		V	V	$\Omega$	mA
6	8.006	4.8	6.6	4.6	367
12	8.012	9.6	13.2	19	183
24	8.024	19.2	26.4	74	90
48	8.048	38.4	52.8	290	47
60	8.060	48	66	450	37
110	8.110	88	121	1600	20
120	8.120	96	132	1940	18.6
230	8.230	184	253	7250	10.5
240	8.240	192	264	8500	9.2
400	8.400	320	440	19800	6

DC (NO/nPST-NO) version data -  $\geq 3$  mm

Nominal voltage $U_N$	Coil code	Operating range		Resistance R	Rated coil consumption I at $U_N$
		$U_{min}$	$U_{max}$		
V		V	V	$\Omega$	mA
6	9.006	5.1	6.6	12	500
12	9.012	10.2	13.2	48	250
24	9.024	20.4	26.4	192	125
48	9.048	40.8	52.8	770	63
60	9.060	51	66	1200	50
110	9.110	93.5	121	4200	26
125	9.125	106	138	5200	24
220	9.220	187	242	17600	12.5

AC (NO/nPST-NO) version data -  $\geq 3$  mm

Nominal voltage $U_N$	Coil code	Operating range		Resistance R	Rated coil consumption I at $U_N$ (50Hz)
		$U_{min}$	$U_{max}$		
V		V	V	$\Omega$	mA
6	8.006	5.1	6.6	4	540
12	8.012	10.2	13.2	14	275
24	8.024	20.4	26.4	62	130
48	8.048	40.8	52.8	220	70
60	8.060	51	66	348	55
110	8.110	93.5	121	1200	30
120	8.120	106	137	1350	24
230	8.230	196	253	5000	14
240	8.240	204	264	6300	12.5
400	8.400	340	440	14700	7.8

DC (NO/nPST-NO) magnetic blow version -  $\geq 2.1$  mm or  $\geq 4.2$  mm

Nominal voltage $U_N$	Coil code	Operating range		Resistance R	Rated coil consumption I at $U_N$
		$U_{min}$	$U_{max}$		
V		V	V	$\Omega$	mA
6	9.006	5.1	6.6	28	214
12	9.012	10.2	13.2	110	109
24	9.024	20.4	26.4	445	54
48	9.048	40.8	52.8	1770	27
60	9.060	51	66	2760	21.7
110	9.110	93.5	121	9420	11.7
125	9.125	106	138	12000	10.4
220	9.220	154*	242	37300	5.8

\* Special version with  $U_{min} = 70\% U_N$

## Coil specifications

**R 62 - DC coil operating range v ambient temperature**  
Changeover contacts

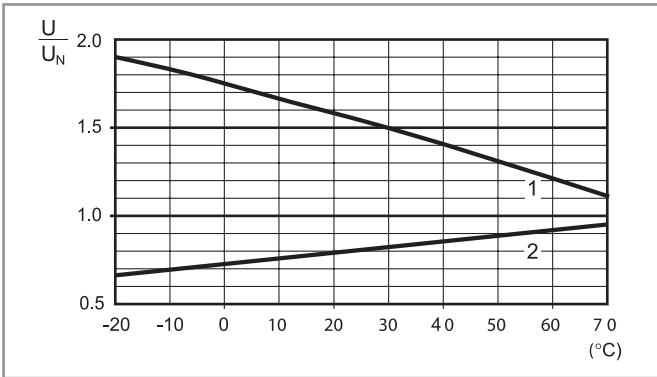

- 1 - Max. permitted coil voltage.
- 2 - Min. pick-up voltage with coil at ambient temperature.

**R 62 - AC coil operating range v ambient temperature**  
Changeover contacts

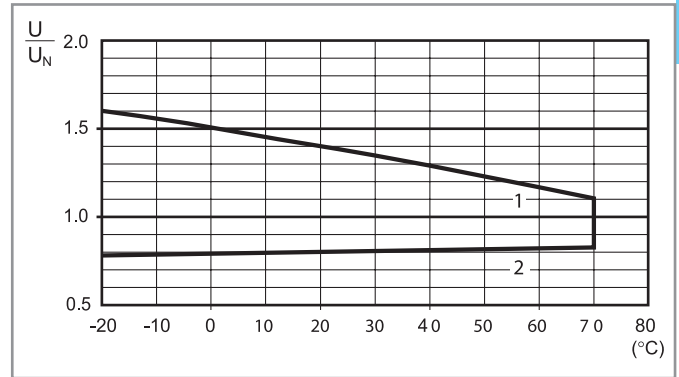

- 1 - Max. permitted coil voltage.
- 2 - Min. pick-up voltage with coil at ambient temperature.

**R 62 - DC coil operating range v ambient temperature**  
Normally open contacts

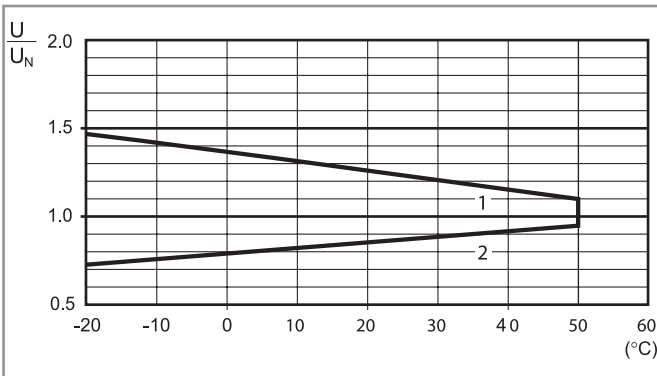

- 1 - Max. permitted coil voltage.
- 2 - Min. pick-up voltage with coil at ambient temperature.

**R 62 - AC coil operating range v ambient temperature**  
Normally open contacts

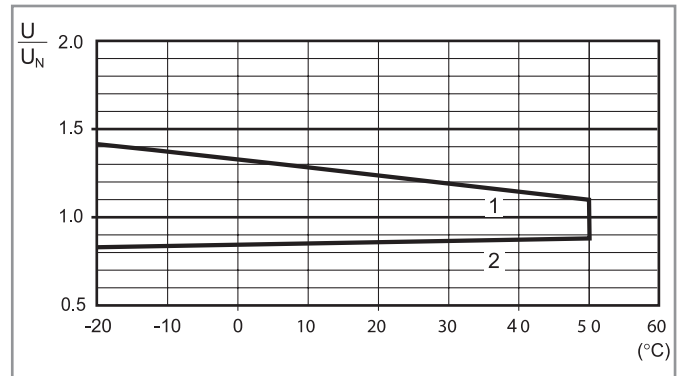

- 1 - Max. permitted coil voltage.
- 2 - Min. pick-up voltage with coil at ambient temperature.

**R 62 - DC coil operating range v ambient temperature**  
Normally open contacts - magnetic blow version

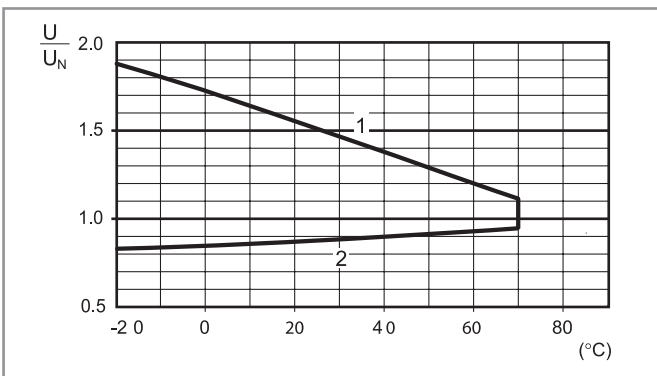

- 1 - Max. permitted coil voltage.
- 2 - Min. pick-up voltage with coil at ambient temperature.

Outline drawings

A

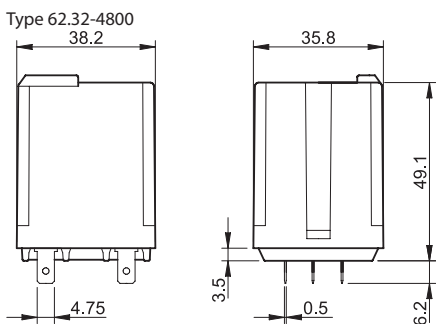
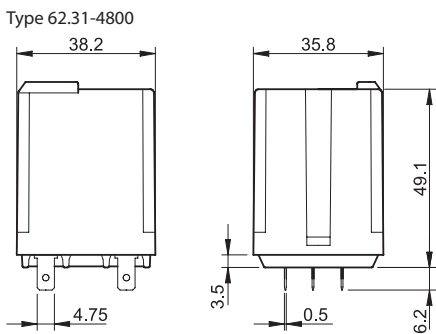
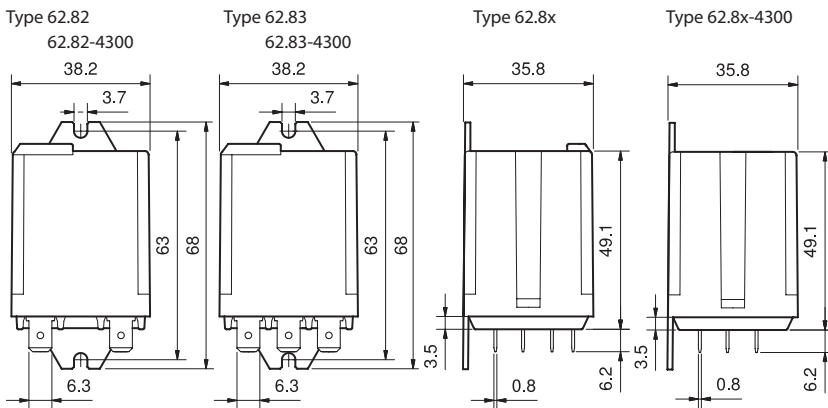
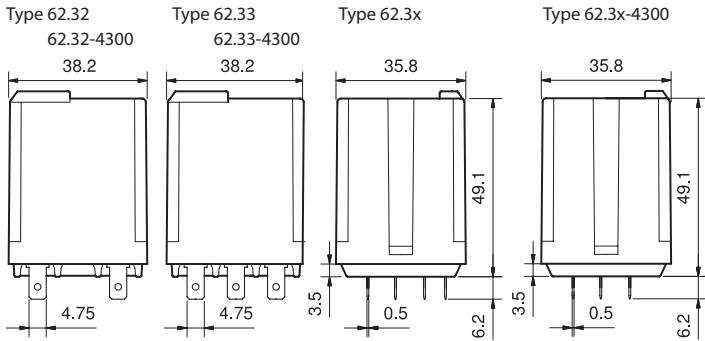
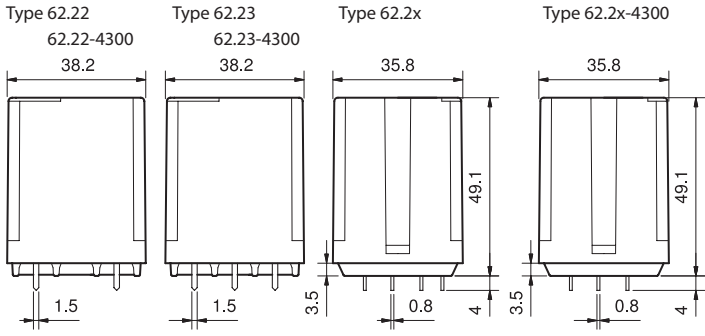



Accessories



062.10



062.10 with relay

Mounting adaptor for types 62.3x and 62.8x.xxxx.xxx9 (M4)

062.10

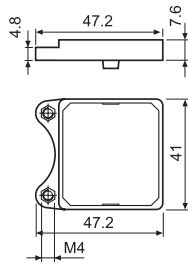

062.10

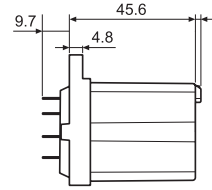
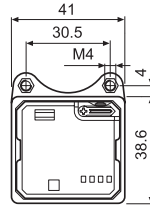

062.10 with relay

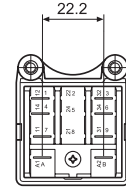

062.60



062.60 with relay

Flange mounting adaptor for types 62.3x and 62.8x.xxxx.xxx9

062.60

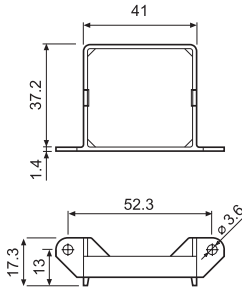

062.60

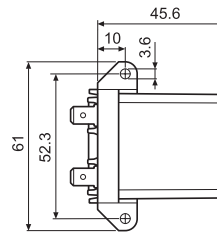

062.60 with relay

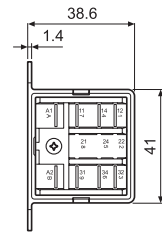

062.05



062.05 with relay

Top flange mount for types 62.3x and 62.8x.xxxx.xxx9

062.05

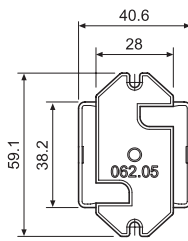

062.05

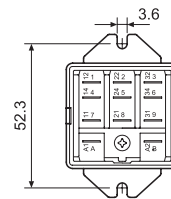
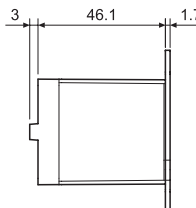

062.05 with relay

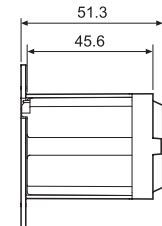

062.07



062.07 with relay

Top 35 mm rail (EN 60715) mount for types 62.3x and 62.8x.xxxx.xxx9

062.07

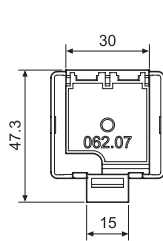

062.07

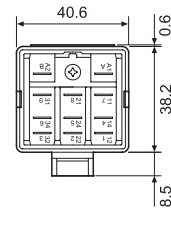
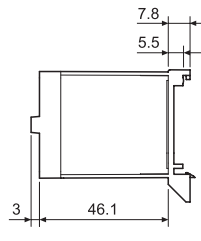

062.07 with relay

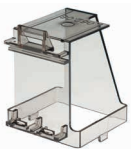
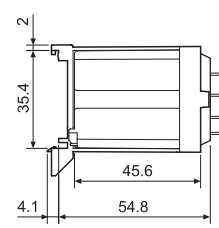

062.08



062.08 with relay

Rear 35 mm rail (EN 60715) mount for types 62.3x and 62.8x.xxxx.xxx9

062.08

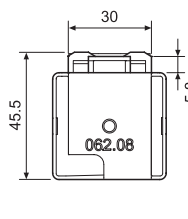

062.08

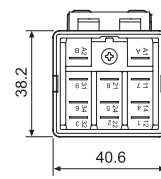
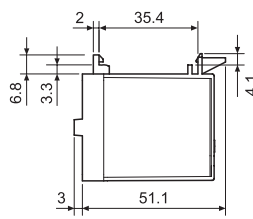

062.08 with relay

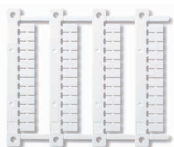
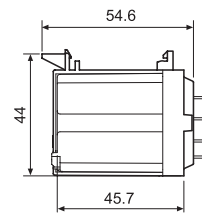

060.48

Sheet of marker tags (CEMBRE Thermal transfer printers) for 62 series relays, plastic, 48 tags, 6 x 12 mm

060.48

A

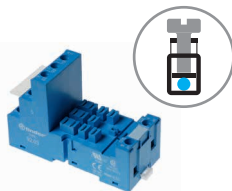

**92.03**  
Approvals  
(according to type):



Screw terminal (Box clamp) socket panel or 35 mm rail (EN 60715) mount	92.03 Blue	92.03.0 Black
For relay type	62.31, 62.32, 62.33	
<b>Accessories</b>		
Metal retaining clip (supplied with socket - packaging code SMA)		092.71
Identification tag		092.00.2
Modules (see table below)		99.02
Timer modules (see table below)		86.00, 86.30
<b>Technical data</b>		
Rated values	16 A - 250 V	
Dielectric strength	6 kV (1.2/50 μs) between coil and contacts	
Protection category	IP 20	
Ambient temperature	°C -40...+70 (see diagram L92)	
Screw torque	Nm	0.8
Wire strip length	mm 10	
Max. wire size for 92.03 socket	solid wire	stranded wire
	mm <sup>2</sup>	1 x 10 / 2 x 4
	AWG	1 x 8 / 2 x 12

**L 92 - Rated current v ambient temperature**

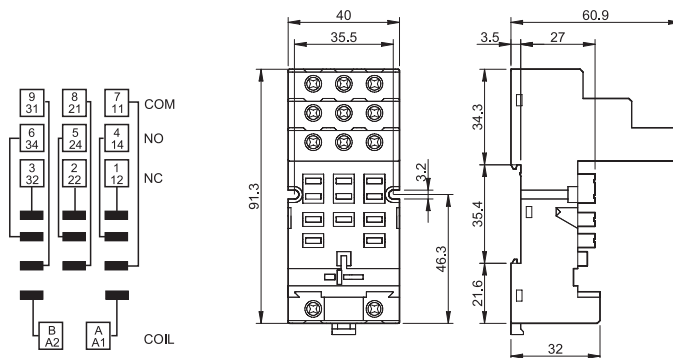
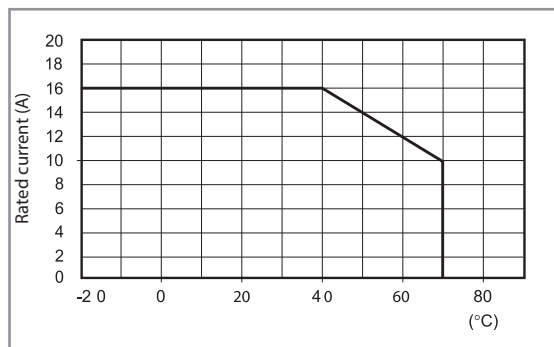

**86.00**



**86.30**



**99.02**  
Approvals  
(according to type):



DC Modules with  
non-standard polarity  
(+A2) on request.

<b>86 series timer modules</b>	
Multi-voltage: (12...240)V AC/DC; Multi-functions: AI, DI, SW, BE, CE, DE, EE, FE; (0.05 s...100 h)	86.00.0.240.0000
(12...24)V AC/DC; Bi-function: AI, DI; (0.05 s...100 h)	86.30.0.024.0000
(110...125)V AC; Bi-function: AI, DI; (0.05 s...100 h)	86.30.8.120.0000
(230...240)V AC; Bi-function: AI, DI; (0.05 s...100 h)	86.30.8.240.0000

Approvals  
(according to type):

<b>99.02 coil indication and EMC suppression modules for 92.03 socket</b>		
Diode (+A1, standard polarity)	(6...220)V DC	99.02.3.000.00
LED	(6...24)V DC/AC	99.02.0.024.59
LED	(28...60)V DC/AC	99.02.0.060.59
LED	(110...240)V DC/AC	99.02.0.230.59
LED + Diode (+A1, standard polarity)	(6...24)V DC	99.02.9.024.99
LED + Diode (+A1, standard polarity)	(28...60)V DC	99.02.9.060.99
LED + Diode (+A1, standard polarity)	(110...220)V DC	99.02.9.220.99
LED + Varistor	(6...24)V DC/AC	99.02.0.024.98
LED + Varistor	(28...60)V DC/AC	99.02.0.060.98
LED + Varistor	(110...240)V DC/AC	99.02.0.230.98
RC circuit	(6...24)V DC/AC	99.02.0.024.09
RC circuit	(28...60)V DC/AC	99.02.0.060.09
RC circuit	(110...240)V DC/AC	99.02.0.230.09
Residual current by-pass*	(110...240)V AC	99.02.8.230.07

\* Additional 0.9 W power dissipation

A



**92.13**  
Approvals  
(according to type):

<b>PCB socket</b>	<b>92.13 (blue)</b>	<b>92.13.0 (black)</b>
For relay type	62.31, 62.32, 62.33	
<b>Accessories</b>		
Metal retaining clip (supplied with socket - packaging code SMA)	092.54	
<b>Technical data</b>		
Rated values	10 A - 250 V	
Dielectric strength	2.5 kV AC	
Ambient temperature	°C -40...+70	

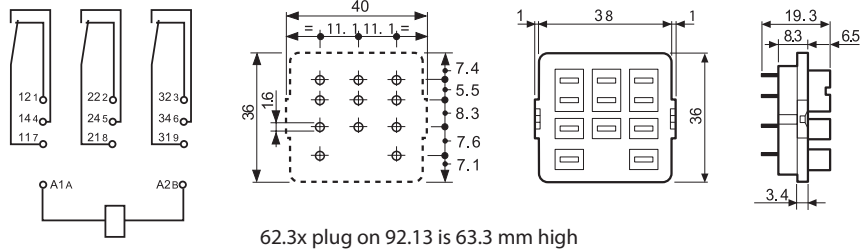

**92.33**  
Approvals  
(according to type):

<b>Panel mount solder socket</b> mounted with M3 screw	<b>92.33 (blue)</b>
For relay type	62.31, 62.32, 62.33
<b>Accessories</b>	
Metal retaining clip (supplied with socket - packaging code SMA)	092.54
<b>Technical data</b>	
Rated values	10 A - 250 V
Dielectric strength	2.5 kV AC
Ambient temperature	°C -40...+70

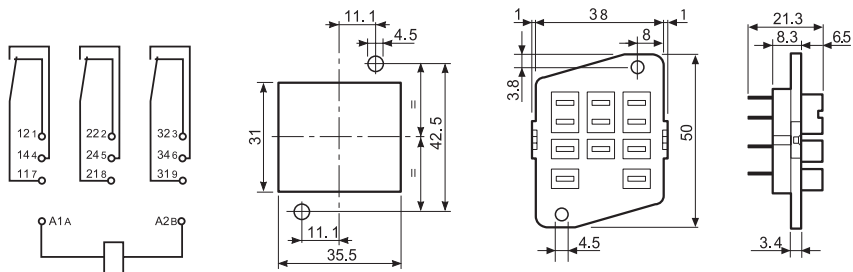

## Packaging codes

How to code and identify retaining clip and packaging options for sockets.

Example:

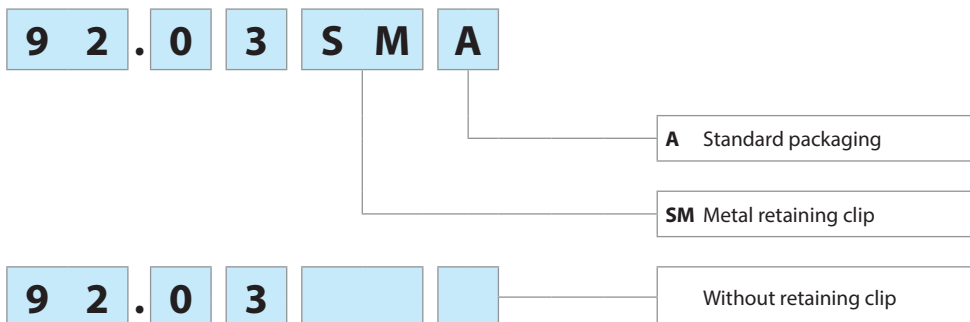



# Power relays 20 - 30 A



Infrared and  
microwave  
ovens



Industrial washing  
machines



Burners,  
boilers and  
furnaces



Jacuzzis and  
hot tubs



Power  
generators



Panels for electrical  
distribution



Back-up  
generators



Industrial  
motors

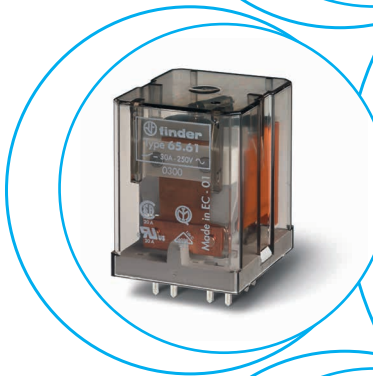
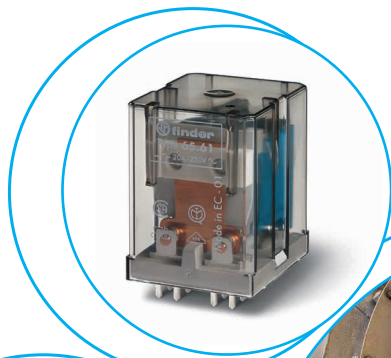



**20 A Power relays**  
**1 NO + 1 NC (SPST-NO + SPST-NC)**

**Type 65.31**  
- Flange mount and Faston 250 connections

**Type 65.61**  
- PCB mount

- AC coils & DC coils



- 20 A rated contacts
- Faston 250 (6.3 x 0.8 mm) connection
- Flange mount

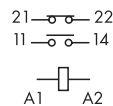

- 20 A rated contacts
- PCB mount
- Bifurcated terminals

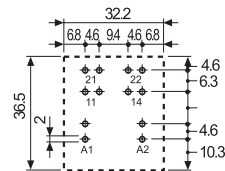
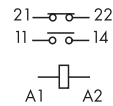

Copper side view

\* Maximum peak current is 120 A - 5 ms on NO contact.

FOR UL RATINGS SEE:

"General technical information" page V

For outline drawing see page 7

**Contact specification**

Contact configuration		1NO + 1NC (SPST-NO+SPST-NC)	1NO + 1NC (SPST-NO+SPST-NC)
Rated current/Maximum peak current	A	20/120*	20/120*
Rated voltage/Maximum switching voltage	V AC	250/400	250/400
Rated load AC1	VA	5000	5000
Rated load AC15 (230 V AC)	VA	1000	1000
Single phase motor rating (230 V AC)	kW	1.1	1.1
Breaking capacity DC1: 24/110/220 V	A	20/0.8/0.5	20/0.8/0.5
Minimum switching load	mW (V/mA)	1000 (10/10)	1000 (10/10)
Standard contact material		AgSnO <sub>2</sub>	AgSnO <sub>2</sub>

**Coil specification**

Nominal voltage (U <sub>N</sub> )	V AC (50/60 Hz)	6 - 12 - 24 - 48 - 60 - 110 - 120 - 230 - 240 - 400	
	V DC	6 - 12 - 24 - 48 - 60 - 110 - 125 - 220	
Rated power AC/DC	VA (50 Hz)/W	2.2/1.3	2.2/1.3
Operating range	AC	(0.8...1.1)U <sub>N</sub>	(0.8...1.1)U <sub>N</sub>
	DC	(0.85...1.1)U <sub>N</sub>	(0.85...1.1)U <sub>N</sub>
Holding voltage	AC/DC	0.8 U <sub>N</sub> / 0.6 U <sub>N</sub>	0.8 U <sub>N</sub> / 0.6 U <sub>N</sub>
Must drop-out voltage	AC/DC	0.2 U <sub>N</sub> / 0.1 U <sub>N</sub>	0.2 U <sub>N</sub> / 0.1 U <sub>N</sub>

**Technical data**

Mechanical life AC/DC	cycles	10 · 10 <sup>6</sup> / 30 · 10 <sup>6</sup>	10 · 10 <sup>6</sup> / 30 · 10 <sup>6</sup>
Electrical life at rated load AC1	cycles	80 · 10 <sup>3</sup>	80 · 10 <sup>3</sup>
Operate/release time	ms	10/12	10/12
Insulation between coil and contacts (1.2/50 μs)	kV	4	4
Dielectric strength between open contacts	V AC	1500	1500
Ambient temperature range	°C	-40...+75	-40...+75
Environmental protection		RT I	RT I

**Approvals** (according to type)



A

**30 A Power relays  
1 NO (SPST-NO)**

**Type 65.31-4300**

- Flange mount and Faston 250 connections

**Type 65.61-4300**

- PCB mount

- ≥ 3 mm contact gap
- AC coils & DC coils

**65.31-4300**



- 30 A rated contacts
- Faston 250 (6.3 x 0.8 mm) connection
- Flange mount

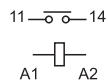

**65.61-4300**



- 30 A rated contacts
- PCB mount
- Bifurcated terminals

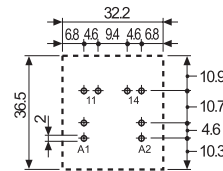
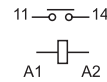

Copper side view

\* Distance between contacts ≥ 3 mm (EN 60335-1).

\*\* Maximum peak current is 120 A - 5 ms on NO contact.

FOR UL RATINGS SEE:

"General technical information" page V

For outline drawing see page 7

**Contact specification**

Contact configuration		1 NO (SPST-NO), ≥ 3 mm*	1 NO (SPST-NO), ≥ 3 mm*
Rated current/Maximum peak current	A	30/120**	30/120**
Rated voltage/Maximum switching voltage	V AC	250/400	250/400
Rated load AC1	VA	7500	7500
Rated load AC15 (230 V AC)	VA	1250	1250
Single phase motor rating (230 V AC)	kW	1.5	1.5
Breaking capacity DC1: 24/110/220 V	A	30/1.1/0.7	30/1.1/0.7
Minimum switching load	mW (V/mA)	1000 (10/10)	1000 (10/10)
Standard contact material		AgSnO <sub>2</sub>	AgSnO <sub>2</sub>

**Coil specification**

Nominal voltage (U <sub>N</sub> )	V AC (50/60 Hz)	6 - 12 - 24 - 48 - 60 - 110 - 120 - 230 - 240 - 400
	V DC	6 - 12 - 24 - 48 - 60 - 110 - 125 - 220
Rated power AC/DC	VA (50 Hz)/W	2.2/1.3
Operating range	AC	(0.8...1.1)U <sub>N</sub>
	DC	(0.85...1.1)U <sub>N</sub>
Holding voltage	AC/DC	0.8 U <sub>N</sub> / 0.6 U <sub>N</sub>
Must drop-out voltage	AC/DC	0.2 U <sub>N</sub> / 0.1 U <sub>N</sub>

**Technical data**

Mechanical life AC/DC	cycles	10 · 10 <sup>6</sup> / 30 · 10 <sup>6</sup>	10 · 10 <sup>6</sup> / 30 · 10 <sup>6</sup>
Electrical life at rated load AC1	cycles	50 · 10 <sup>3</sup>	50 · 10 <sup>3</sup>
Operate/release time	ms	15/4	15/4
Insulation between coil and contacts (1.2/50 μs)	kV	4	4
Dielectric strength between open contacts	V AC	2500	2500
Ambient temperature range	°C	-40...+75	-40...+75
Environmental protection		RT I	RT I

**Approvals** (according to type)





## Ordering information

Example: 65 series power relay, PCB with bifurcated terminals, 1 NO + 1 NC (SPST-NO + SPST-NC) contact, 12 V DC coil.

	<b>6</b>	<b>5</b>	.	<b>6</b>		<b>1</b>	.	<b>9</b>	.	<b>0</b>	<b>1</b>	<b>2</b>	.	<b>4</b>	<b>0</b>		<b>0</b>	<b>0</b>	
														<b>A</b>	<b>B</b>		<b>C</b>	<b>D</b>	
<b>Series</b>	65.6					1.9.0					012.4					000			
<b>Type</b>	3 = Faston 250 (6.3 x 0.8 mm) with rear flange mount 6 = PCB with bifurcated terminals					1 = 1 NO + 1 NC (SPST-NO + SPST-NC)					4 = AgSnO <sub>2</sub>					0 = Standard 9 = Type 65.31 without rear flange mount			
<b>No. of poles</b>											0 = 1 NO + 1 NC (SPST-NO + SPST-NC) 3 = NO (≥ 3 mm contact gap)					<b>C: Options</b> 0 = None			
<b>Coil version</b>	8 = AC (50/60 Hz) 9 = DC																		
<b>Coil voltage</b>	See coil specifications																		

**Selecting features and options: only combinations in the same row are possible.**  
Preferred selections for best availability are shown in **bold**.

Type	Coil version	A	B	C	D
65.31	AC-DC	4	<b>0</b> - 3	<b>0</b>	<b>0</b> - 9
65.61	AC-DC	4	<b>0</b> - 3	<b>0</b>	<b>0</b>

## Technical data

Insulation according to EN 61810-1					
		1 NO + 1 NC		1 NO	
Nominal voltage supply system	V AC	230/400		230/400	
Rated insulation voltage	V AC	250	400	250	400
Pollution degree		3	2	3	2
<b>Insulation between coil and contact set</b>					
Type of insulation		Basic		Basic	
Overtoltage category		III		III	
Rated impulse voltage	kV (1.2/50 μs)	4		4	
Dielectric strength	V AC	2500		2500	
<b>Insulation between open contacts</b>					
Type of disconnection		Micro-disconnection		Full-disconnection	
Overtoltage category		—		III	
Rated impulse voltage	kV (1.2/50 μs)	—		4	
Dielectric strength	V AC/kV (1.2/50 μs)	1500/2		2500/4	
<b>Insulation between coil terminals</b>					
Rated impulse voltage (surge) differential mode (according to EN 61000-4-5)	kV (1.2/50 μs)	4			
<b>Other data</b>					
Bounce time: NO/NC	ms	5/6 (1 NO + 1 NC)		7/— (1 NO)	
Vibration resistance (10...150)Hz: NO/NC	g	20/13			
Shock resistance	g	20			
Power lost to the environment	without contact current	W	1.3		
	with rated current	W	2.1 (65.31, 65.61)		3.1 (65.31/61.4300)
Recommended distance between relays mounted on PCB	mm	≥ 5			

## Contact specification

F 65 - Electrical life (AC) v contact current

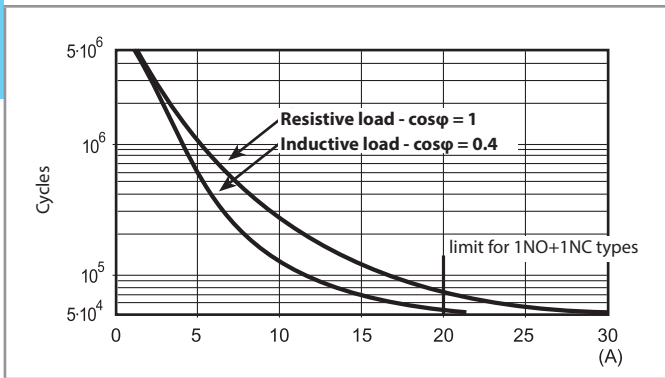

H 65 - Maximum DC1 breaking capacity

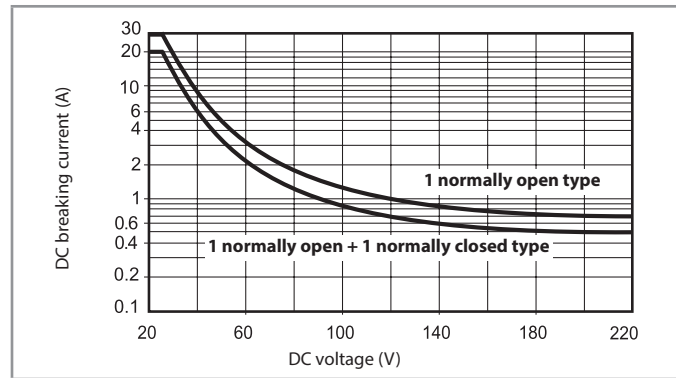

- When switching a resistive load (DC1) having voltage and current values under the curve, an electrical life of  $\geq 80 \cdot 10^3$  can be expected.
- In the case of DC13 loads, the connection of a diode in parallel with the load will permit a similar electrical life as for a DC1 load.  
Note: the release time for the load will be increased.

## Coil specifications

DC coil data

Nominal voltage $U_N$ V	Coil code	Operating range		Resistance R $\Omega$	Rated coil consumption I at $U_N$ mA
		$U_{min}$ V	$U_{max}$ V		
6	9.006	5.1	6.6	28	214
12	9.012	10.2	13.2	110	109
24	9.024	20.4	26.4	445	54
48	9.048	40.8	52.8	1770	27.1
60	9.060	51	66	2760	21.7
110	9.110	93.5	121	9420	11.7
125	9.125	106	138	12000	10.4
220	9.220	187	242	37300	5.8

AC coil data

Nominal voltage $U_N$ V	Coil code	Operating range		Resistance R $\Omega$	Rated coil consumption I at $U_N$ (50 Hz) mA
		$U_{min}$ V	$U_{max}$ V		
6	8.006	4.8	6.6	4.6	367
12	8.012	9.6	13.2	19	183
24	8.024	19.2	26.4	74	90
48	8.048	38.4	52.8	290	47
60	8.060	48	66	450	37
110	8.110	88	121	1600	20
120	8.120	96	132	1940	18.6
230	8.230	184	253	7250	10.5
240	8.240	192	264	8500	9.2
400	8.400	320	440	19800	6

R 65 - DC coil operating range v ambient temperature

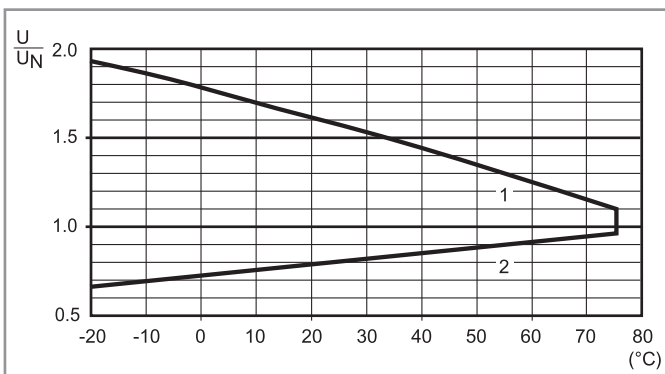

- 1 - Max. permitted coil voltage.
- 2 - Min. pick-up voltage with coil at ambient temperature.

R 65 - AC coil operating range v ambient temperature

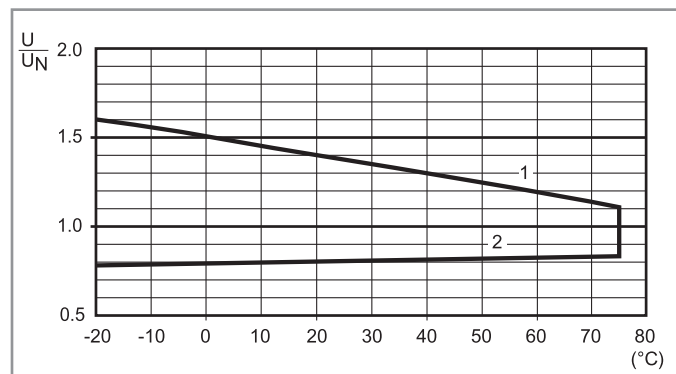

- 1 - Max. permitted coil voltage.
- 2 - Min. pick-up voltage with coil at ambient temperature.

## Outline drawings

Type 65.31

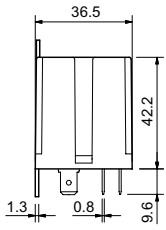

Type 65.61

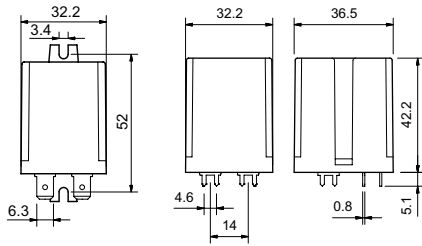

Type 65.31-4300

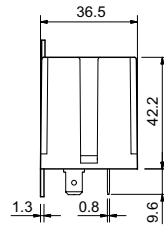

Type 65.61-4300

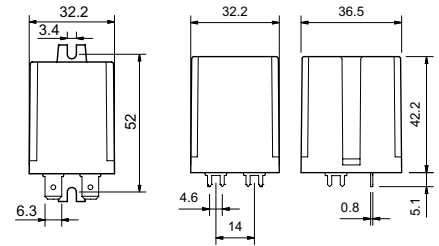

## Accessories



065.05



065.05 with relay

Top flange mount for types 65.31.xxxx.xxx9

065.05

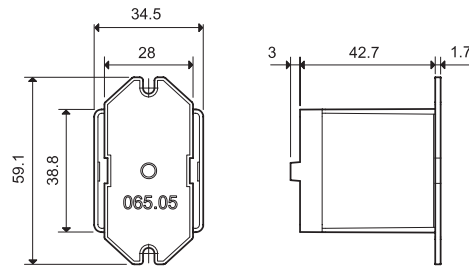

065.05

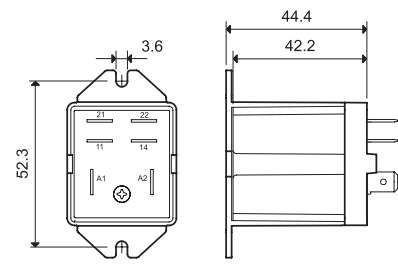

065.05 with relay



065.07



065.07 with relay

Top 35 mm rail (EN 60715) mount for types 65.31.xxxx.xxx9

065.07

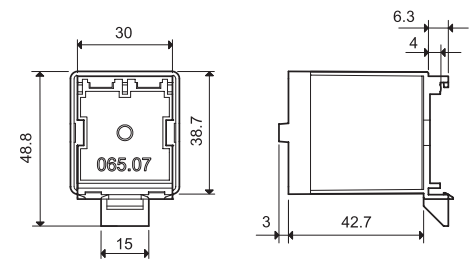

065.07

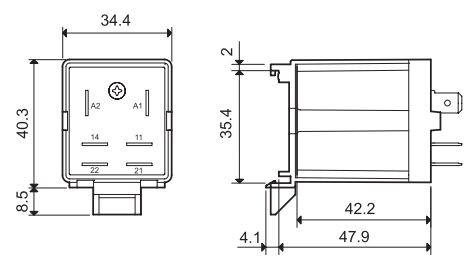

065.07 with relay



065.08



065.08 with relay

Rear 35 mm rail (EN 60715) mount for types 65.31.xxxx.xxx9

065.08

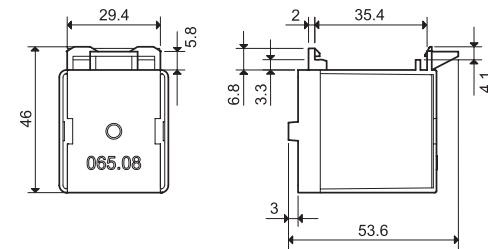

065.08

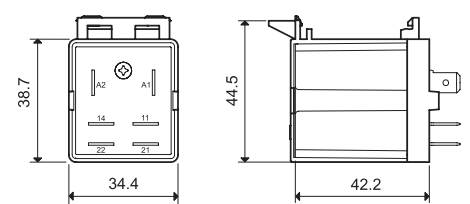

065.08 with relay



# Power relays 30 A



Power generators



Industrial washing machines



Burners, boilers and furnaces



Industrial furnaces and ovens



Air conditioners



Hoists and cranes



Back-up generators



Industrial motors







**2 Pole NO (DPST-NO)  
30 A Power relay**

**Type 66.22-x30x**

- PCB mount

**Type 66.82-x30x**

- Faston 250 connections and Flange mount

- Reinforced insulation between coil and contacts according to EN 60335-1; 8 mm creepage and clearance distances
- AC coils & DC coils
- Cadmium Free option available
- **ATEX** compliant (EX ec nC) option available\*
- **HazLoc** Class I Div. 2 Group A, B, C, D - T4 - T5 - T6 option available\*

\* Characteristics page 8, 9

FOR UL RATINGS SEE:

"General technical information" page V

For outline drawing see page 10

**Contact specification**

Contact configuration

Rated current/Maximum peak current A

Rated voltage/  
Maximum switching voltage V AC

Rated load AC1 VA

Rated load AC15 (230 V AC) VA

Single phase motor rating (230 V AC) kW

Breaking capacity DC1: 24/110/220 V A

Minimum switching load mW (V/mA)

Standard contact material

**Coil specification**

Nominal voltage (U<sub>N</sub>)

V AC (50/60 Hz)

V DC

Rated power AC/DC VA (50 Hz)/W

Operating range

AC

DC

Holding voltage

AC/DC

Must drop-out voltage

AC/DC

**Technical data**

Mechanical life AC/DC cycles

Electrical life at rated load AC1 cycles

Operate/release time ms

Insulation between coil and contacts (1.2/50 μs) kV

Dielectric strength between open contacts V AC

Ambient temperature range °C

Environmental protection

**Approvals** (according to type)

**66.22-x30x**



- 30 A rated contacts
- PCB mount - bifurcated terminals

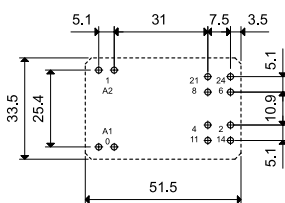
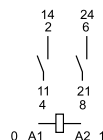

Copper side view

**66.82-x30x**



- 30 A rated contacts
- Flange mount
- Faston 250 connections

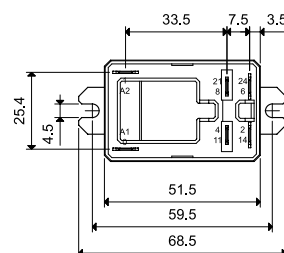
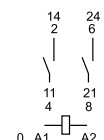

2 NO (DPST-NO)

2 NO (DPST-NO)

30/50

30/50

250/440

250/440

7500

7500

1200

1200

1.5

1.5

25/0.7/0.3

25/0.7/0.3

1000 (10/10)

1000 (10/10)

AgSnO<sub>2</sub>

AgSnO<sub>2</sub>

6 - 12 - 24 - 110/115 - 120/125 - 230 - 240

6 - 9 - 12 - 24 - 110 - 125

3.6/1.7

3.6/1.7

(0.8...1.1)U<sub>N</sub>

(0.8...1.1)U<sub>N</sub>

(0.8...1.1)U<sub>N</sub>

(0.8...1.1)U<sub>N</sub>

0.8 U<sub>N</sub> / 0.5 U<sub>N</sub>

0.8 U<sub>N</sub> / 0.5 U<sub>N</sub>

0.2 U<sub>N</sub> / 0.1 U<sub>N</sub>

0.2 U<sub>N</sub> / 0.1 U<sub>N</sub>

10 · 10<sup>6</sup>

10 · 10<sup>6</sup>

100 · 10<sup>3</sup>

100 · 10<sup>3</sup>

8/10

8/10

6 (8 mm)

6 (8 mm)

1500

1500

-40...+70

-40...+70

RT II

RT II





**2 Pole NO (DPST-NO), ≥ 1.5 mm contact gap  
30 A Power relay**

**Type 66.22-x60x**

- PCB mount

**Type 66.22-x60xS**

- PCB mount, 5 mm gap between PCB and relay base

**Type 66.82-x60x**

- Faston 250 connections and Flange mount

- ≥ 1.5 mm contact gap (according to VDE 0126-1-1 for solar inverter applications)
- Reinforced insulation between coil and contacts according to EN 60335-1; 8 mm creepage and clearance distances
- Wash tight version (RT III) available
- DC coils
- Cadmium Free option available
- **ATEX** compliant (EX ec nC) option available\*
- **HazLoc** Class I Div. 2 Group A, B, C, D - T4 - T5 - T6 option available\*

\* Characteristics page 8, 9

FOR UL RATINGS SEE:

"General technical information" page V

For outline drawing see page 10

**Contact specification**

Contact configuration		2 NO (DPST-NO)	2 NO (DPST-NO)	2 NO (DPST-NO)
Rated current/Maximum peak current	A	30/50	30/50	30/50
Rated voltage/				
Maximum switching voltage	V AC	250/440	250/440	250/440
Rated load AC1	VA	7500	7500	7500
Rated load AC15 (230 V AC)	VA	1200	1200	1200
Single phase motor rating (230 V AC)	kW	1.5	1.5	1.5
Breaking capacity DC1: 24/110/220 V	A	25/1.2/0.5	25/1.2/0.5	25/1.2/0.5
Minimum switching load	mW (V/mA)	1000 (10/10)	1000 (10/10)	1000 (10/10)
Standard contact material		AgSnO <sub>2</sub>	AgSnO <sub>2</sub>	AgSnO <sub>2</sub>

**Coil specification**

Nominal voltage (U <sub>N</sub> )	V AC (50/60 Hz)	—		
	V DC	6 - 9 - 12 - 24 - 110 - 125		
Rated power AC/DC	VA (50 Hz)/W	—/1.7	—/1.7	—/1.7
Operating range	AC	—		
	DC	(0.8...1.1)U <sub>N</sub>		
Holding voltage	AC/DC	—/0.5 U <sub>N</sub>		
Must drop-out voltage	AC/DC	—/0.1 U <sub>N</sub>		

**Technical data**

Mechanical life	cycles	10 · 10 <sup>6</sup>	10 · 10 <sup>6</sup>	10 · 10 <sup>6</sup>
Electrical life at rated load AC1	cycles	100 · 10 <sup>3</sup>	100 · 10 <sup>3</sup>	100 · 10 <sup>3</sup>
Operate/release time	ms	15/4	15/4	15/4
Insulation between coil and contacts (1.2/50 μs)	kV	6 (8 mm)	6 (8 mm)	6 (8 mm)
Dielectric strength between open contacts	V AC	2500	2500	2500
Ambient temperature range	°C	-40...+70	-40...+70	-40...+70
Environmental protection		RT II	RT II	RT II

**Approvals (according to type)**

**66.22-x60x**



- PCB mount - bifurcated terminals

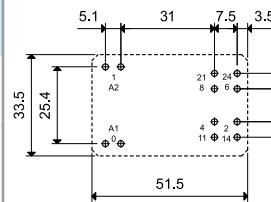
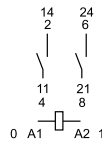

Copper side view

**66.22-x60xS**



- PCB mount - bifurcated terminals
- 5 mm gap between PCB and relay base

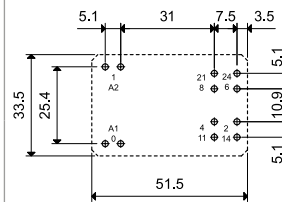
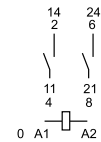

Copper side view

**66.82-x60x**



- Flange mount
- Faston 250 connections

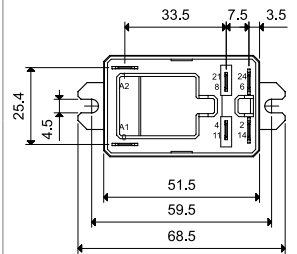
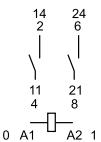

## Ordering information

Example: 66 series relay, Faston 250 (6.3x0.8 mm) with top flange mount, 2 CO (DPDT) 30 A contacts, 24 V DC coil.

A



**Series**  
**Type**  
2 = PCB  
8 = Faston 250 (6.3 x 0.8 mm)  
with top flange mount  
**No. of poles**  
2 = 2 pole 30 A (versions 0, 1)  
2 = 2 pole 25 A (version 3)  
**Coil version**  
8 = AC (50/60 Hz)  
9 = DC  
**Coil voltage**  
See coil specifications

**A: Contact material**  
0 = AgCdO  
only ATEX versions  
1 = AgNi  
4 = Standard AgSnO<sub>2</sub>  
**B: Contact circuit**  
0 = CO (nPDT)  
3 = NO (nPST)  
6 = NO (nPST), ≥ 1.5 mm  
contact gap

S = PCB version with  
5 mm gap  
between PCB and  
relay base  
(only 66.22 and  
Atex/HazLoc  
versions)

**D: Special versions**  
0 = Standard  
1 = Wash tight (RT III)  
3 = Atex (Ex ec nC) and HazLoc  
Class I Div. 2 compliant

**C: Options**  
0 = None

**Selecting features and options: only combinations in the same row are possible.**

**Options for ATEX/HAZLOC versions: only combinations in the same row are possible.**

Preferred selections for best availability are shown in **bold**.

Type	Coil version	A	B	C	D
66.22	AC - DC	<b>4 - 1</b>	<b>0 - 3</b>	<b>0</b>	<b>0 - 1</b>
	DC	<b>4 - 1</b>	<b>6</b>	<b>0</b>	<b>0 - 1</b>
66.22...S	DC	<b>4 - 1</b>	<b>6</b>	<b>0</b>	<b>0 - 1</b>
66.82	AC - DC	<b>4 - 1</b>	<b>0 - 3</b>	<b>0</b>	<b>0 - 1</b>
	DC	<b>4 - 1</b>	<b>6</b>	<b>0</b>	<b>0 - 1</b>

Type	Coil version	A	B	C	D
66.22...S	DC	0 - 1	0 - 3 - 6	0	<b>3</b>
66.82	AC - DC	0 - 1	0 - 3	0	<b>3</b>
	DC	0 - 1	6	0	<b>3</b>

## Technical data

### Insulation according to EN 61810-1

Nominal voltage of supply system	V AC	230/400
Rated insulation voltage	V AC	400
Pollution degree		3
<b>Insulation between coil and contact set</b>		
Type of insulation		Reinforced (8 mm)
Overvoltage category		III
Rated impulse voltage	kV (1.2/50 μs)	6
Dielectric strength	V AC	4000
<b>Insulation between adjacent contacts</b>		
Type of insulation		Basic
Overvoltage category		III
Rated impulse voltage	kV (1.2/50 μs)	4
Dielectric strength	V AC	2500
<b>Insulation between open contacts</b>		
Type of disconnection		<b>2 CO</b> Micro-disconnection <b>2 NO, ≥ 1.5 mm (x60x version)</b> Full-disconnection*
Overvoltage category		—      II
Rated impulse voltage	kV (1.2/50 μs)	—      2.5
Dielectric strength	V AC/kV (1.2/50 μs)	1500/2      2500/2.5
<b>Insulation between coil terminals</b>		
Rated impulse voltage (surge) differential mode (according to EN 61000-4-5)	kV (1.2/50 μs)	4
<b>Other data</b>		
Bounce time: NO/NC	ms	7/10
Vibration resistance (10...150)Hz: NO/NC	g	20/19
Shock resistance	g	20
Power lost to the environment	without contact current	W 2.3
	with rated current	W 5
Recommended distance between relays mounted on PCB	mm	≥ 10

\* Only in applications where over voltage category II is permitted. In applications of over voltage category III: Micro-disconnection.

### Contact specification

**F 66 - Electrical life (AC) v contact current**  
250 V (normally open contact)

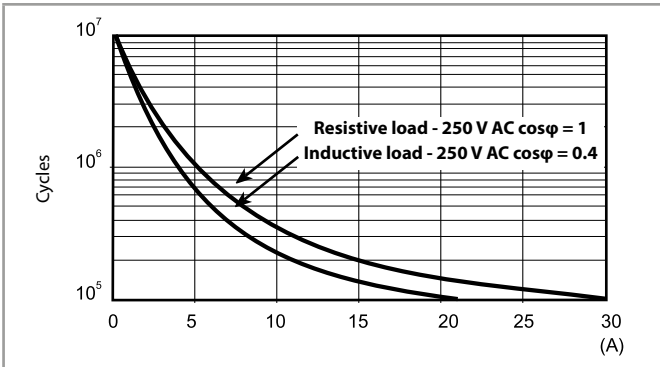

**F 66 - Electrical life (AC) v contact current**  
440 V (normally open contact)

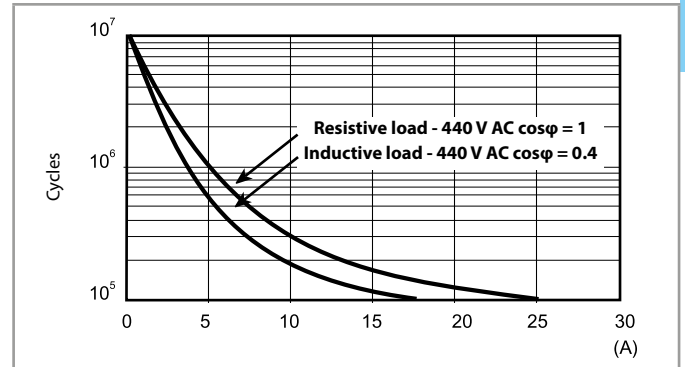

**H 66 - Maximum DC breaking capacity**

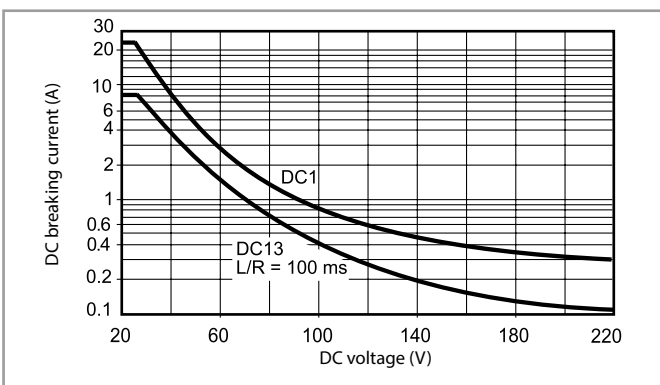

**H 66 - Maximum DC breaking capacity, x60x versions**  
(> 1.5 mm contact gap)

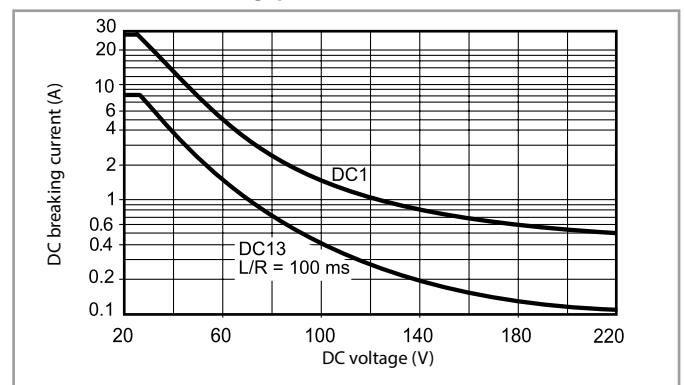

- When switching a resistive load (DC1) having voltage and current values under the curve, an electrical life of  $\geq 100 \cdot 10^3$  can be expected.
- In the case of DC13 loads, the connection of a diode in parallel with the load will permit a similar electrical life as for a DC1 load.  
Note: the release time for the load will be increased.

### Coil specifications

#### DC coil data

Nominal voltage $U_N$ V	Coil code	Operating range		Resistance R $\Omega$	Rated coil Consumption I at $U_N$ mA
		$U_{min}$ V	$U_{max}$ V		
6	9.006	4.8	6.6	21	283
9	9.009	7.2	9.9	45	200
12	9.012	9.6	13.2	85	141
24	9.024	19.2	26.4	340	70.5
110	9.110	88	121	7000	15.7
125	9.125	100	138	9200	13.6

#### AC coil data

Nominal voltage $U_N$ V	Coil code	Operating range		Resistance R $\Omega$	Rated coil Consumption I at $U_N$ (50 Hz) mA
		$U_{min}$ V	$U_{max}$ V		
6	8.006	4.8	6.6	3	600
12	8.012	9.6	13.2	11	300
24	8.024	19.2	26.4	50	150
110/115	8.110	88	126	930	32.6
120/125	8.120	96	137	1050	30
230	8.230	184	253	4000	15.7
240	8.240	192	264	5500	15

**R 66 - DC coil operating range v ambient temperature**

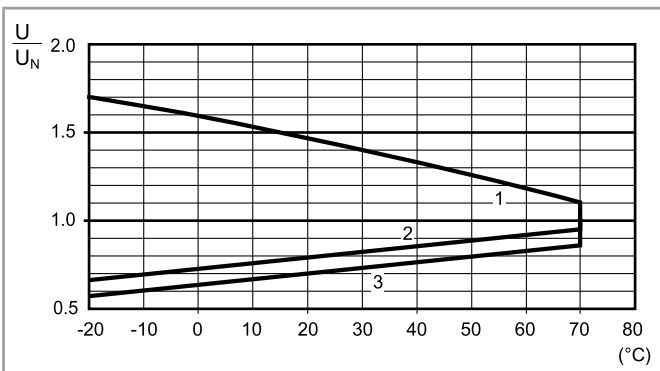

**R 66 - AC coil operating range v ambient temperature**

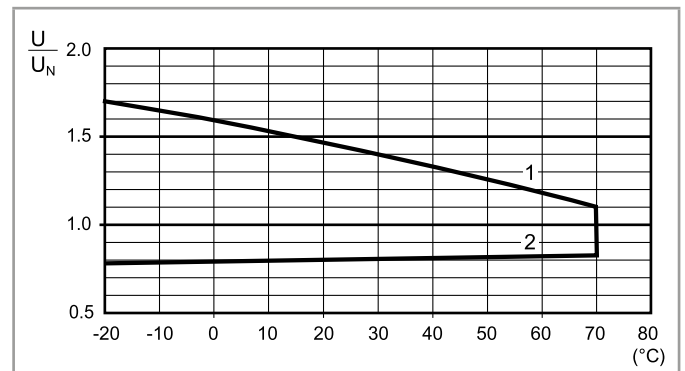

- 1 - Max. permitted coil voltage.  
2 - Min. pick-up voltage with coil at ambient temperature.  
3 - Min. pick-up voltage with coil at ambient temperature (66.22-x60x5)

- 1 - Max. permitted coil voltage.  
2 - Min. pick-up voltage with coil at ambient temperature.

## ATEX - Electrical characteristics

Contact specification ATEX	66.82	66.22...S
Rated current/Maximum peak current	A 30/50 (NO) - 10/20 (NC)	25/50 (NO) - 10/20 (NC)
Rated voltage/Maximum switching voltage	V AC	250/440
Rated load AC1	VA 7500 (NO) - 2500 (NC)	6250 (NO) - 2500 (NC)
Rated load AC15	VA	1200 (NO)
Capacity for single phase motor (230 V AC)	kW	1.5 (NO)
Breaking capacity DC1: 30/110/220 V	A	25/0.7/0.3 (NO)
<b>Characteristics of coil</b>		
Rated voltage (U <sub>N</sub> )	V AC (50/60 Hz)	6 - 12 - 24 - 110/115 - 120/125 - 230 - 240
	V DC	6 - 12 - 24 - 110 - 125
Rated Power AC/DC	VA (50 Hz)/W	3.6/1.7
Operating range	AC/DC	(0.8...1.1)U <sub>N</sub>
<b>General characteristics</b>		
Ambient temperature	°C	-40...+70

## Special condition for safe use

The component must be placed inside an enclosure that ensures a degree of protection IP54 (or greater) according to standard EN 60529 and EN 60079-0 and that complies with the requirements of type of protection "Ex e" and EPL Gc (or better).

## Wiring

The cross-section of conductors connected to the terminals, must be at least 4 mm<sup>2</sup> for the Type 66.82.

The connections must be made in compliance with the requirements of clause 4.2 of EN IEC 60079-7:2015+A1:2018.

## Layout pcb

The minimum cross-section of the tracks of the printed circuit board must be 0.58 mm<sup>2</sup>, while the width must be at least 4.01 mm for Type 66.22...S.

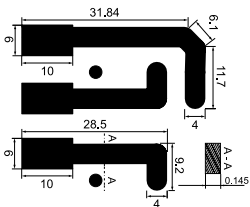

## Markings - ATEX versions - ATEX, II 3G Ex ec nC IIC Gc

MARKING	
	Specific marking of explosion protection
II	Component for surface plant (different from mines)
3	Category 3: normal level of protection
GAS	<b>G</b> Explosive atmosphere due to presence of combustible gas vapour or mist
	<b>Ex ec</b> Increased safety (type of protection for category 3G)
	<b>Ex nC</b> Sealed device (type of protection for category 3G)
	<b>IIC</b> Gas group
	<b>Gc</b> Equipment Protection Level
<b>-40 °C ≤ Ta ≤ +70 °C</b> Ambient temperature	
<b>EPTI 17 ATEX 0299 U</b> EPTI: laboratory which issues the voluntary type certificate 17: year of issue of certificate 0299: number of CE type certificate	
U: Ex component	
Xyy: production batch identification (X year, yy week)	

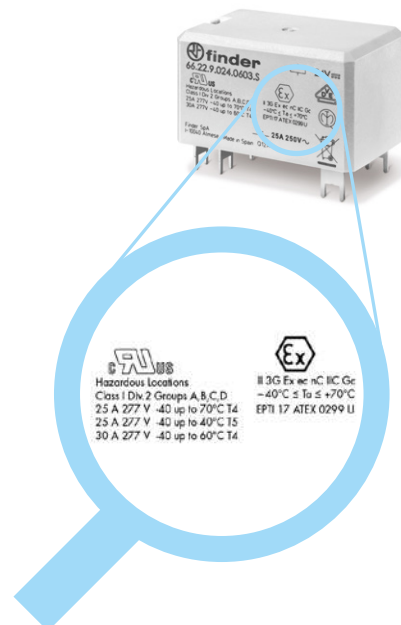

## Markings - Hazardous Location Class I Div. 2 Groups A, B, C, D - T4 - T5 - T6 and other data

HazLoc Class I Div. 2 Group A, B, C, D - T4 - T5 - T6		Meaning
Class I		Areas in which flammable gases and vapours may be present
Div. 2		Low probability to find ignitable concentration of hazards because are typically present in containers or closed systems from which can escape through their accidental rupture or breakdown
Group A, B, C, D		Kind of combustible, flammable gases and vapours can be in the atmosphere.
Permissible Surface temperature		
T4	135 °C	275 °F
T5	100 °C	212 °F
T6	85 °C	185 °F

A

Model	T4				
	Type of load	Voltage	Current/Power	Temperature °C	Note
66.22	DC General Use Res Heating	30 V	25 A	-40...+70	only 66.xx.9.x6x3
66.22/66.82	AC Motor Starting, Discharge Lamps Break All lines	240 V	2 Hp	-40...+70	12FLA/69 LRA
		120 V	1 Hp	—	16FLA/96 LRA
		120 V	1/2 Hp	—	9.8FLA/58.8 LRA

Model	T5				
	Type of load	Voltage	Current/Power	Temperature °C	Note
66.22.x.xxx.xxx3 x	DC General Use Res Heating	30 V	30 A	-40...+60	only 66.xx.9.x6x3
	AC Motor Starting, Discharge Lamps Break All lines	240 V	2 Hp	-40...+60	12FLA/69 LRA
		120 V	1 Hp		16FLA/96 LRA
		120 V	1/2 Hp		9.8FLA/58.8 LRA
T6					
	Type of load	Voltage	Current	Temperature °C	—
	AC General Use	277 V	10 A (NC)	-40...+70	—

Model	T5				
	Type of load	Voltage	Current/Power	Temperature °C	Note
66.82.x.xxx.xxx3 x	AC General Use	277 V	25 (NO)	-40...+40	—
	DC General Use	30 V	30 A	-40...+60	only 66.xx.9.x6x3
	AC Motor Starting, Discharge Lamps Break All lines	240 V	2 Hp	-40...+60	12FLA/69 LRA
		120 V	1 Hp		16FLA/96 LRA
		120 V	1/2 Hp		9.8FLA/58.8 LRA
T6					
	Type of load	Voltage	Current	Temperature °C	—
	AC General Use	277 V	10 A (NC)	-40...+70	—

## HazLoc - Electrical characteristics

Contact specification HazLoc		HazLoc Class I Div. 2 T4 @ 60°C	HazLoc Class I Div. 2 T4 @ 70°C
Rated current/Maximum peak current	A	30/50 (NO) - 10/20 (NC)	25/50 (NO) - 10/20 (NC)
Rated voltage/Maximum switching voltage	V AC	250/400	250/400
Rated load AC1	VA	7500 (NO) - 2500 (NC)	6250 (NO) - 2500 (NC)
Rated load AC15	VA	1200 (NO)	1200 (NO)
Capacity for single phase motor (230 V AC)	kW	1.5 (NO)	1.5 (NO)
Breaking capacity DC1: 30/110/220 V	A	25/0.7/0.3 (NO)	25/0.7/0.3 (NO)
Characteristics of coil			
Rated voltage (U <sub>N</sub> )	V AC (50/60 Hz)	6 - 12 - 24 - 110/115 - 120/125 - 230 - 240	
	V DC	6 - 12 - 24 - 110 - 125	
Rated Power AC/DC	VA (50 Hz)/W	3.6/1.7	
Operating range	AC/DC	(0.8...1.1)U <sub>N</sub>	
General characteristics			
Ambient temperature	°C	-40...+70	

## Outline drawings

A

Type 66.22

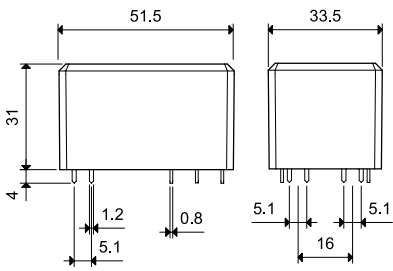

Type 66.82

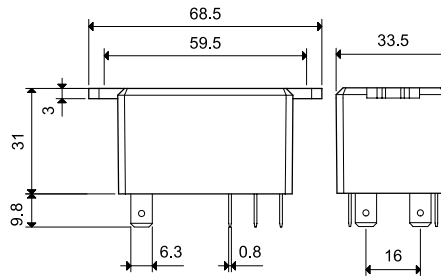

Type 66.22-x300

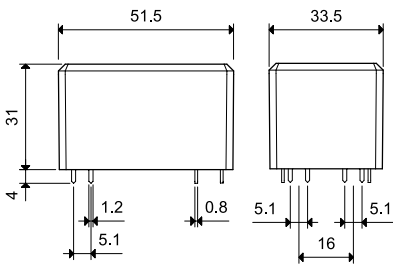

Type 66.82-x300

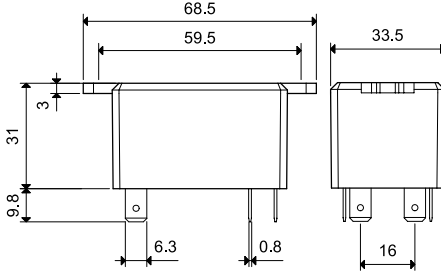

Type 66.22-x600

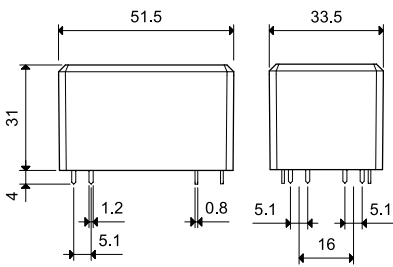

Type 66.82-x600

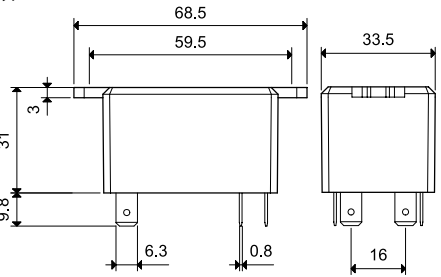

Type 66.22-x600S

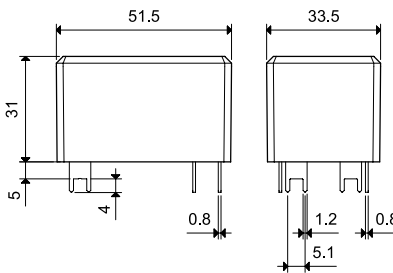

## Accessories

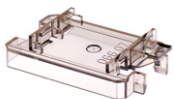

066.07



066.07 with relay

Top 35 mm rail (EN 60715) mount for types 66.82.xxxx-xx00

066.07

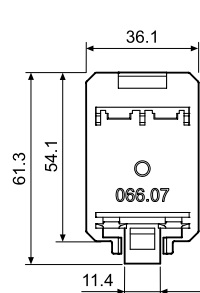

066.07

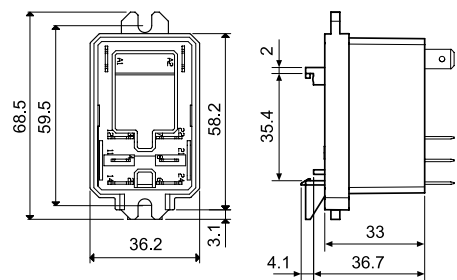
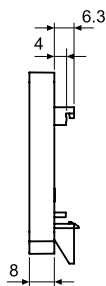

066.07 with relay

# High Power relay 50 A



Power generators



Back-up generators



Pump control



Disabled lift



Inverter







**Printed circuit mount - 3 mm contact gap  
50 A Power relay for photovoltaic inverters**

**Type 67.22-x300**  
- 2 NO

**Type 67.23-x300**  
- 3 NO

- Contact gap  $\geq 3$  mm (according to VDE 0126-1-1, EN 62109-1, EN 62109-2)
- DC coils, with only 170 mW holding power
- Reinforced insulation between coil and contacts
- 1.5 mm gap between PCB and relay base
- Suitable for use at ambient temperatures up to 85 °C (with energy-saving coil energization) or 70 °C (with standard coil energization)
- Meets the EN 60335-1 requirements of resistance to heat and fire (GWIT 775 °C and GWFI 850 °C)
- Cadmium free contact materials:
  - AgNi version (for applications where lower contact resistance is needed)
  - AgSnO<sub>2</sub> version (for applications where higher inrush current values are expected)

For outline drawing see page 8

**Contact specification**

Contact configuration		2 NO (DPST-NO)	3 NO (3PST-NO)
Contact gap	mm	$\geq 3$	$\geq 3$
Rated current/ Maximum peak current (for 5 ms)	A	50/150	50/150
Rated voltage/ Maximum switching voltage	V AC	400/690	400/690
Rated load AC1/AC7a (per pole)	VA	20000	20000
Rated load AC15 (per pole @ 230 V AC)	VA	2300	2300
Single-phase motor rating (230 V AC)	kW	2.2	2.2
Three-phase motor rating (480 V AC)	kW	—	11
Breaking capacity DC1: 24/110/220 V	A	50/4/1	50/4/1
Minimum switching load	mW (V/mA)	1000 (10/10)	1000 (10/10)
Standard contact material		AgSnO <sub>2</sub>	AgSnO <sub>2</sub>

**Coil specification**

Nominal voltage (U <sub>N</sub> )	V DC	5 - 6 - 8 - 12 - 24 - 48	
Rated power	W	1.7	1.7
Operating range (-40...+70)°C	DC	(0.90 ... 1.1)U <sub>N</sub>	(0.90 ... 1.1)U <sub>N</sub>
Energy-saving mode (-40...+85)°C			
Operating range for 1 s		(0.95...2.5)U <sub>N</sub>	(0.95...2.5)U <sub>N</sub>
Holding voltage range	DC	(0.32...0.65)U <sub>N</sub>	(0.32...0.65)U <sub>N</sub>
Minimum holding power	W	0.17	0.17
Must drop-out voltage	DC	0.05 U <sub>N</sub>	0.05 U <sub>N</sub>

**Technical data**

Mechanical life	cycles	1 · 10 <sup>6</sup>	1 · 10 <sup>6</sup>
Electrical life at rated load AC7a	cycles	30 · 10 <sup>3</sup>	30 · 10 <sup>3</sup>
Operate/release time	ms	25/5	25/5
Ambient temperature range (energy-saving mode)	°C	-40...+70 (-40...+85)	-40...+70 (-40...+85)
Environmental protection		RT II	RT II

**Approvals** (according to type)



**67.22-x300**



- 2 NO
- Contact gap  $\geq 3$  mm
- PCB mount

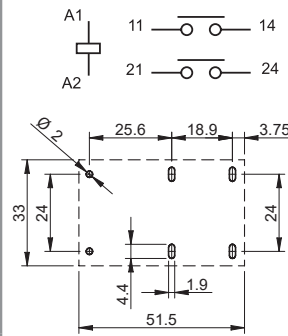

Copper side view

**67.23-x300**



- 3 NO
- Contact gap  $\geq 3$  mm
- PCB mount

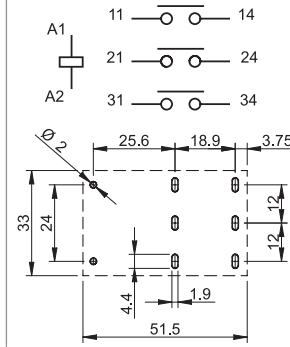

Copper side view

**Printed circuit mount - 5.2 mm contact gap  
50 A Power relay for photovoltaic inverters**

**Type 67.22-x500**  
- 2 NO

**Type 67.23-x500**  
- 3 NO

- Contact gap  $\geq 5.2$  mm (according to VDE 0126-1-1, EN 62109-1, EN 62109-2)
- DC coils, with only 170 mW holding power
- Reinforced insulation between coil and contacts
- 1.5 mm gap between PCB and relay base
- Suitable for use at ambient temperatures up to 85 °C (with energy-saving coil energization) or 60 °C (with standard coil energization)
- Meets the EN 60335-1 requirements of resistance to heat and fire (GWIT 775 °C and GWFI 850 °C)
- Cadmium free contact materials:
  - AgNi version (for applications where lower contact resistance is needed)
  - AgSnO<sub>2</sub> version (for applications where higher inrush current values are expected)

**67.22-x500**



- 2 NO
- Contact gap  $\geq 5.2$  mm
- PCB mount

**67.23-x500**



- 3 NO
- Contact gap  $\geq 5.2$  mm
- PCB mount

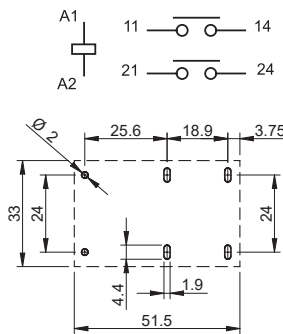

Copper side view

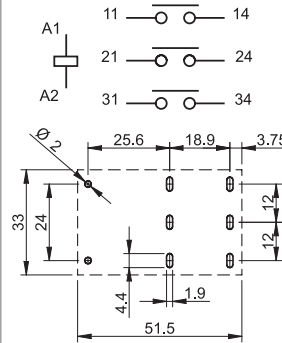

Copper side view

For outline drawing see page 8

**Contact specification**

Contact configuration		2 NO (DPST-NO)	3 NO (3PST-NO)
Contact gap	mm	$\geq 5.2$	$\geq 5.2$
Rated current/ Maximum peak current (for 5 ms)	A	50/150	50/150
Rated voltage/ Maximum switching voltage	V AC	400/690	400/690
Rated load AC1/AC7a (per pole)	VA	20000	20000
Rated load AC15 (per pole @ 230 V AC)	VA	2300	2300
Single-phase motor rating (230 V AC)	kW	2.2	2.2
Three-phase motor rating (480 V AC)	kW	—	11
Breaking capacity DC1: 24/110/220	A	50/7/2	50/7/2
Minimum switching load	mW (V/mA)	1000 (10/10)	1000 (10/10)
Standard contact material		AgSnO <sub>2</sub>	AgSnO <sub>2</sub>

**Coil specification**

Nominal voltage (U <sub>N</sub> )	V DC	5 - 6 - 8 - 12 - 24 - 48	
Rated power	W	2.7	2.7
Operating range (-40...+60)°C	DC	(0.90 ... 1.1)U <sub>N</sub>	(0.90 ... 1.1)U <sub>N</sub>
Energy-saving mode (-40...+85)°C	Operating range for 1 s	(0.95...2.5)U <sub>N</sub>	(0.95...2.5)U <sub>N</sub>
	Holding voltage range	DC (0.25...0.5)U <sub>N</sub>	(0.25...0.5)U <sub>N</sub>
	Minimum holding power	W	0.17
Must drop-out voltage	DC	0.05 U <sub>N</sub>	0.05 U <sub>N</sub>

**Technical data**

Mechanical life	cycles	1 · 10 <sup>6</sup>	1 · 10 <sup>6</sup>
Electrical life at rated load AC7a	cycles	30 · 10 <sup>3</sup>	30 · 10 <sup>3</sup>
Operate/release time	ms	30/4	30/4
Ambient temperature range (energy-saving mode)	°C	-40...+60 (-40...+85)	-40...+60 (-40...+85)
Environmental protection		RT II	RT II

**Approvals** (according to type)



## Ordering information

Example: 67 series solar relay, single PCB terminals, 2 pole NO, ≥ 3 mm contact gap.

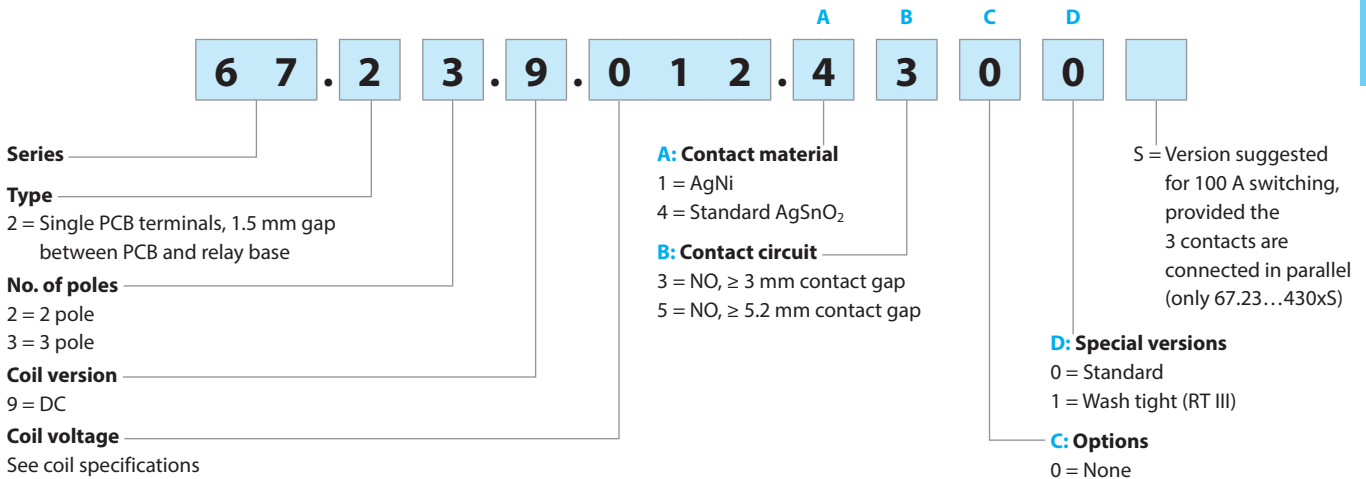

## Technical data

Insulation according to EN 61810-1				
Nominal voltage of supply system	V AC	400/690 3-phase	400 1-phase	230/400
Rated insulation voltage	V AC	630	400	400
Pollution degree		3		
Insulation between coil and contact set				
Type of Insulation		Reinforced		
Overvoltage category		III		
Rated impulse voltage	kV (1.2/50 μs)	6		
Dielectric strength	V AC	4000		
Insulation between adjacent contacts				
Type of Insulation		Basic		
Overvoltage category		III		
Rated impulse voltage	kV (1.2/50)μs	6		
Dielectric strength	V AC	2500		
Insulation between open contacts				
Type of disconnection		Micro-disconnection*		Full-disconnection
Overvoltage category		—		III
Rated impulse voltage	kV (1.2/50)μs	—		4
Dielectric strength	V AC	2500 (67.xx-x300)/3000 (67.xx-x500)		
Insulation between coil terminals				
Rated impulse voltage (surge) differential mode (according to EN 61000-4-5)	kV (1.2/50 μs)	4		
Other data				
Bounce time: NO	ms	2		
Vibration resistance (10...150)Hz: NO	g	15		
Shock resistance	g	35		
Power lost to the environment	without contact current	W	1.7 (67.xx-x300)/2.7 (67.xx-x500)	
	with rated current	W	8.5 (67.xx-x300)/9.5 (67.xx-x500)	
Recommended distance between relays mounted on PCB	mm	≥ 20		
Short circuit protection				
Rated conditional short circuit current	kA	5		
Back-up fuse for motor load	A	30 (delayed type)		

\* with overvoltage category II: Full-disconnection

## Contact specification

F 67 - Electrical life v contact current (AC1/AC7a load)

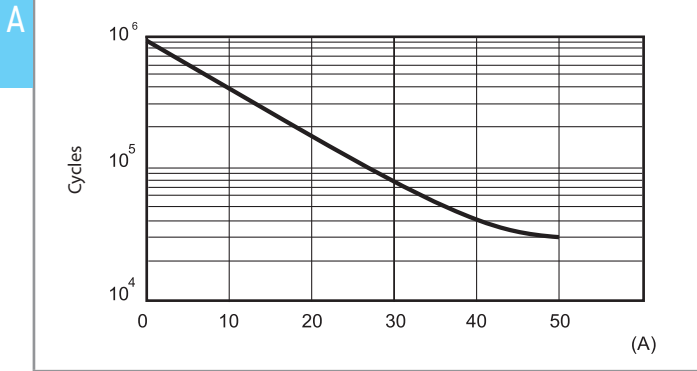

H 67-1 - Maximum DC breaking capacity (67.xx-x300)

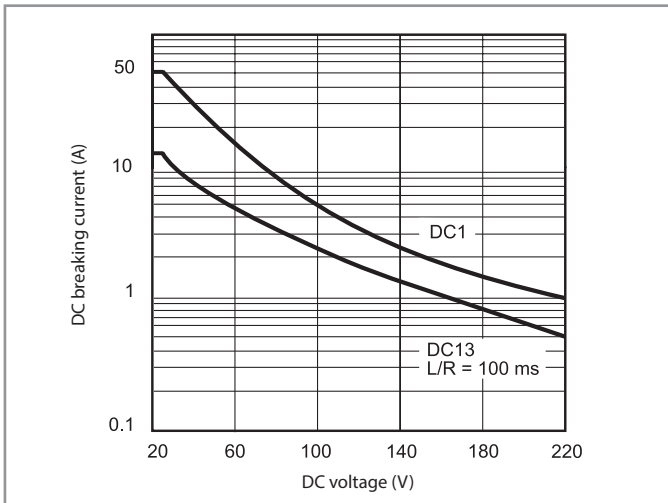

When switching a resistive (DC1) or inductive (DC13) load having voltage and current values under the corresponding curve, an electrical life of > 30000 cycles can be expected.

H 67-2 - Maximum DC breaking capacity (67.xx-x500)

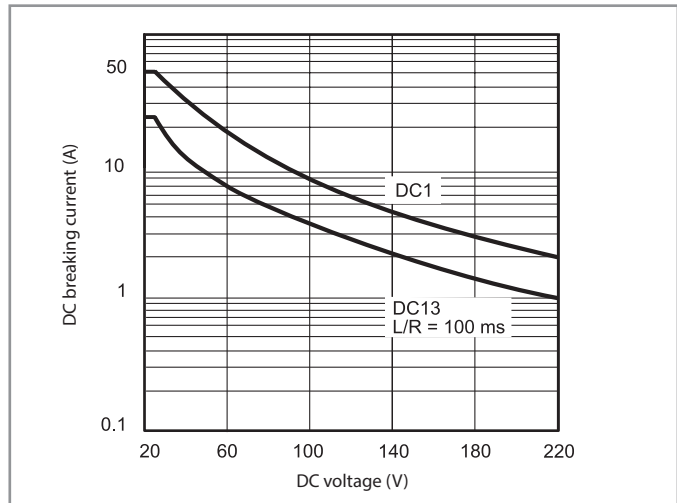

When switching a resistive (DC1) or inductive (DC13) load having voltage and current values under the corresponding curve, an electrical life of > 30000 cycles can be expected.

## Connection of contacts in parallel

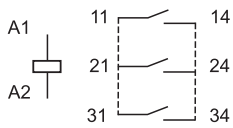

Connecting in parallel the contacts, with appropriate dimensioning of tracks on PC board, allow the relays to carry and switch loads up to 100 A:  
 - 100 A, with 67.23...4300S version  
 - 80 A, with 67.23...1300 version

## Coil specifications

### DC coil data, 67.xx-x300

Nominal voltage $U_N$	Coil code	Operating range (@ 70 °C max)		Holding voltage $U_h$	Resistance $R$	Rated coil consumption I at $U_N$ $I_N$
		$U_{min}$	$U_{max}$			
V		V	V	V	$\Omega$	mA
5	9.005	4.5	5.5	1.6	14.7	340
6	9.006	5.4	6.6	1.9	21.5	279
8	9.008	7.2	8.8	2.6	37.6	213
12	9.012	10.8	13.2	3.8	85	141
24	9.024	21.6	26.4	7.7	340	71
48	9.048	43.2	52.8	15.4	1355	35

### DC coil data, 67.xx-x500

Nominal voltage $U_N$	Coil code	Operating range (@ 60 °C max)		Holding voltage $U_h$	Resistance $R$	Rated coil consumption I at $U_N$ $I_N$
		$U_{min}$	$U_{max}$			
V		V	V	V	$\Omega$	mA
5	9.005	4.5	5.5	1.25	9.3	538
6	9.006	5.4	6.6	1.5	13.5	444
8	9.008	7.2	8.8	2	23.7	338
12	9.012	10.8	13.2	3	53.5	224
24	9.024	21.6	26.4	6	213	113
48	9.048	43.2	52.8	12	855	56

**R 67-1 - Operating range v ambient temperature, 67.xx-x300**  
with standard (continuous) coil energization (-40...+70)°C

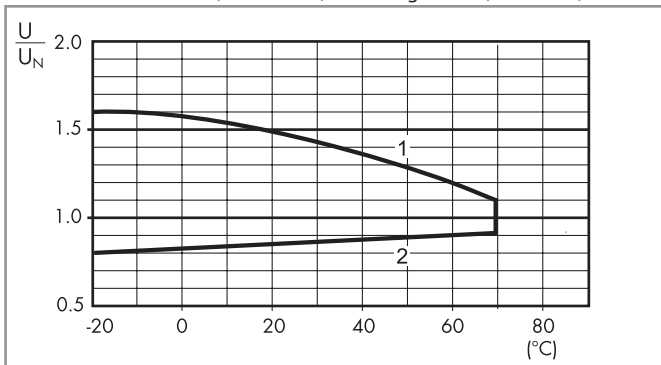

- 1 - Max. permitted coil voltage.
- 2 - Min. pick-up voltage with coil at ambient temperature.

### Energy saving mode

In some applications, such as photovoltaic inverters, it may be necessary to minimize the overall relay power dissipation and to permit use at higher ambient temperature levels (up to 85 °C). This can be achieved by initially applying a coil voltage within the Energy saving mode Operating range (see diagram to the right) and then rapidly (< 1 s) reducing the coil voltage to a level within the Holding voltage range. The lower the Holding voltage, the lower is the continuous power dissipation of the coil (0.17 W minimum).

Coil voltages as high as 2.5  $U_N$  may be used, when necessary, to reduce the contact operate time.

**R 67-2 - Operating range v ambient temperature, 67.xx-x500**  
with standard (continuous) coil energization (-40...+60)°C

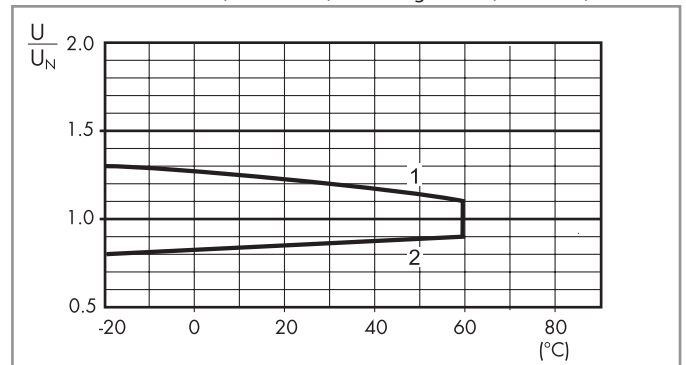

- 1 - Max. permitted coil voltage.
- 2 - Min. pick-up voltage with coil at ambient temperature.

**R 67-3 - Operating range v ambient temperature, 67.xx-x300/x500**  
in energy saving mode (-40...+85)°C

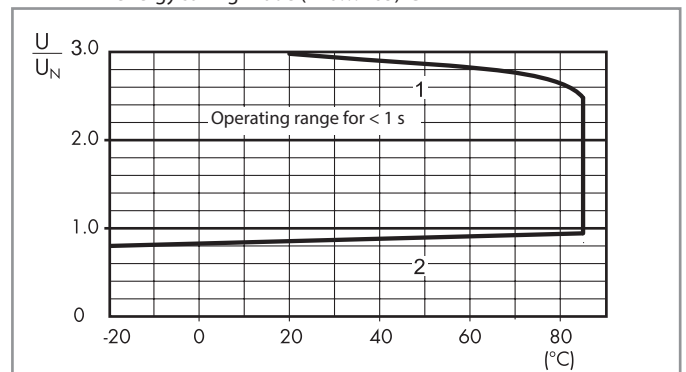

- 1 - Max. permitted coil voltage.
- 2 - Min. pick-up voltage with coil at ambient temperature.

Outline drawings

Type 67.22

Type 67.23

A

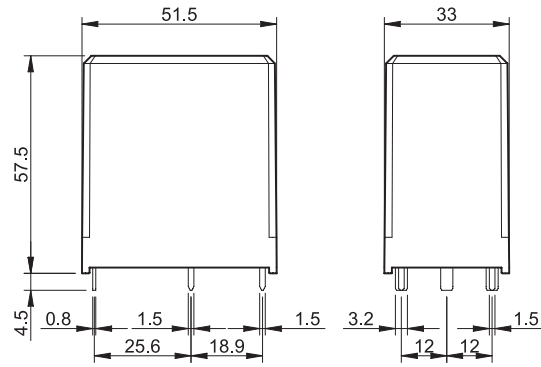
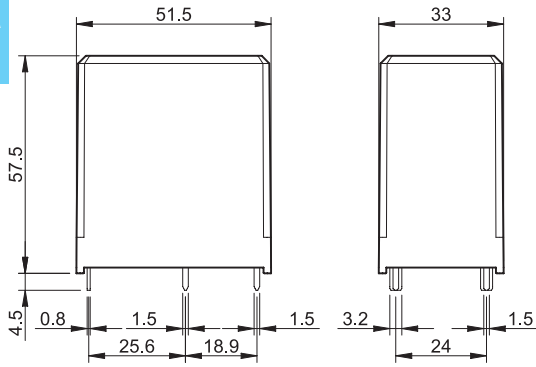

# High Power relays



Power generators



Back-up generators



Pump control



Disabled lift



Inverter



Charging Stations

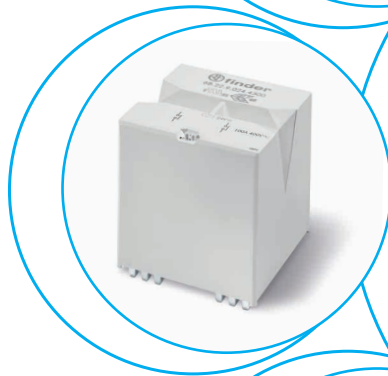





**Printed circuit mount - 3.6 mm contact gap**  
**Relays for applications with high power**

**Type 68.22-4300**  
- 2 NO 100 A

**Type 68.23-4300**  
- 2 NO 100 A  
- 1 NC 3 A (feedback)

- Contact gap  $\geq 3.6$  mm (according to VDE 0126-1-1, EN 62109-1, EN 62109-2)
- DC coils, with only 700 mW holding power
- Reinforced insulation between coil and contacts
- Suitable for use at ambient temperatures up to 85 °C
- Meets the EN 60335-1 requirements of resistance to heat and fire (GWIT 775 °C and GWFI 850 °C)
- Mirror contact (type 68.23) according to EN 60947-4-1 Annex F
- Cadmium free contact materials

For outline drawing see page 9

**Contact specification**

Contact configuration		2 NO	2 NO/1 NC
Contact gap	mm	$\geq 3.6$	$\geq 3.6$
Rated current/ Maximum peak current (for 1 ms)	A	100/300	100/300
Feedback contact configuration		—	1 NC
Rated current NC contact	A	—	3
Rated voltage/ Maximum switching voltage	V AC	400/690	400/690
Rated load AC1 (per pole)	VA	32 000	32 000
Rated load AC7a (per pole)	VA	40 000	40 000
Rated load AC15 (per pole @ 230 V AC)	VA	4600	4600
Single-phase motor rating (230 V AC)	kW	3.5	3.5
Single-phase motor rating (480 V AC)	kW	7	7
Breaking capacity DC1: 24/110/220 V	A	100/5/1.2	100/5/1.2
Minimum switching load NO contacts	mW (V/mA)	1000 (10/10)	1000 (10/10)
Minimum switching load NC contact	mW (V/mA)	—	100 (10/5)
Standard NO contact material		AgSnO <sub>2</sub>	AgSnO <sub>2</sub>
Standard NC feedback contact material		—	AgNi + Au

**Coil specification**

Nominal voltage (U <sub>N</sub> )	V DC	12 - 24	12 - 24
Rated power	W	2.9	2.9
Operating range (-40...+70°C)	DC	(0.90 ... 1.1)U <sub>N</sub>	(0.90 ... 1.1)U <sub>N</sub>
Energy-saving mode (-40...+85)°C			
Operating range for 1 s		(0.95...2.5)U <sub>N</sub>	(0.95...2.5)U <sub>N</sub>
Holding voltage	DC	0.5 U <sub>N</sub>	0.5 U <sub>N</sub>
Minimum holding power	W	0.7	0.7
Must drop-out voltage	DC	0.05 U <sub>N</sub>	0.05 U <sub>N</sub>

**Technical data**

Mechanical life	cycles	1 · 10 <sup>6</sup>	1 · 10 <sup>6</sup>
Electrical life at rated load AC7a	cycles	30 · 10 <sup>3</sup>	30 · 10 <sup>3</sup>
Operate/release time	ms	25/3	25/6
Ambient temperature range (energy-saving mode)	°C	-40...+70 (-40...+85)	-40...+70 (-40...+85)
Environmental protection		RT II	RT II

**Approvals** (according to type)

**68.22-4300**



- 2 NO
- Contact gap 3.6 mm
- PCB mount

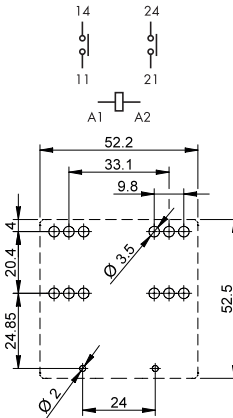

Copper side view

**NEW 68.23-4300**

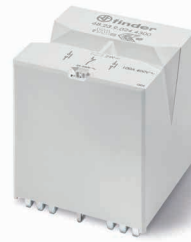

- 2 NO/1 NC
- Contact gap 3.6 mm
- PCB mount

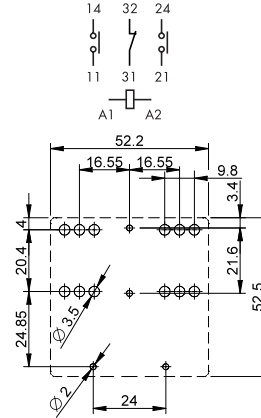

Copper side view

**Printed circuit mount - 3.6 mm contact gap**  
**Relays for applications with high power**
**Type 68.24-4300**

- 4 NO 40 A

**Type 68.25-4300**

 - 4 NO 40 A  
 - 1 NC 3 A (feedback)

- Contact gap  $\geq 3.6$  mm (according to VDE 0126-1-1, EN 62109-1, EN 62109-2)
- DC coils, with only 700 mW holding power
- Reinforced insulation between coil and contacts
- Suitable for use at ambient temperatures up to 85 °C
- Meets the EN 60335-1 requirements of resistance to heat and fire (GWIT 775 °C and GWFI 850 °C)
- Mirror contact (type 68.25) according to EN 60947-4-1 Annex F
- Cadmium free contact materials

For outline drawing see page 9

**Contact specification**

Contact configuration		4 NO	4 NO/1 NC
Contact gap	mm	$\geq 3.6$	$\geq 3.6$
Rated current/ Maximum peak current (for 1 ms)	A	40/300	40/300
Feedback contact configuration		—	1 NC
Rated current NC contact	A	—	3
Rated voltage/ Maximum switching voltage	V AC	250/400	250/400
Rated load AC1/AC7a (per pole)	VA	10 000	10 000
Rated load AC15 (per pole @ 230 V AC)	VA	2300	2300
Single-phase motor rating (230 V AC)	kW	2.2	2.2
Three-phase motor rating (480 V AC)	kW	11	11
Breaking capacity DC1: 24/110/220 V	A	40/4/1	40/4/1
Minimum switching load NO contacts	mW (V/mA)	1000 (10/10)	1000 (10/10)
Minimum switching load NC contacts	mW (V/mA)	—	100 (10/5)
Standard NO contact material		AgSnO <sub>2</sub>	AgSnO <sub>2</sub>
Standard NC feedback contact material		—	AgNi + Au

**Coil specification**

Nominal voltage (U <sub>N</sub> )	V DC	12 - 24	12 - 24
Rated power	W	2.9	2.9
Operating range (-40...+70°C)	DC	(0.90 ... 1.1)U <sub>N</sub>	(0.90 ... 1.1)U <sub>N</sub>
Energy-saving mode (-40...+85°C)			
Operating range for 1 s		(0.95...2.5)U <sub>N</sub>	(0.95...2.5)U <sub>N</sub>
Holding voltage	DC	0.5 U <sub>N</sub>	0.5 U <sub>N</sub>
Minimum holding power	W	0.7	0.7
Must drop-out voltage	DC	0.05 U <sub>N</sub>	0.05 U <sub>N</sub>

**Technical data**

Mechanical life	cycles	1 · 10 <sup>6</sup>	1 · 10 <sup>6</sup>
Electrical life at rated load AC7a	cycles	30 · 10 <sup>3</sup>	30 · 10 <sup>3</sup>
Operate/release time	ms	25/3	25/6
Ambient temperature range (energy-saving mode)	°C	-40...+70 (-40...+85)	-40...+70 (-40...+85)
Environmental protection		RT II	RT II

**Approvals** (according to type)

**NEW 68.24-4300**

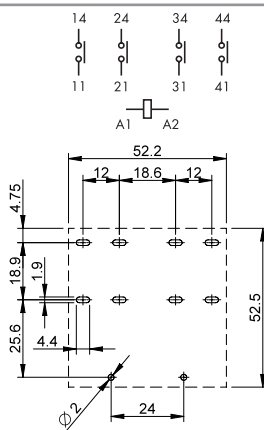

- 4 NO
- Contact gap 3.6 mm
- PCB mount



Copper side view

**NEW 68.25-4300**

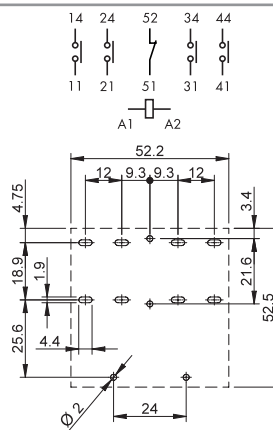
- 4 NO/1 NC
- Contact gap 3.6 mm
- PCB mount



Copper side view

**Printed circuit mount - 3.6 mm contact gap**  
**Relays for applications with high power**  
**Compliant with IEC 62955 for electric vehicles charging stations**

**Type 68.54-4300**

- 4 NO 32 A

**Type 68.55-4300**

- 4 NO 32 A
- 1 NC 3 A (feedback)

- Contact gap  $\geq 3.6$  mm (according to VDE 0126-1-1, EN 62109-1, EN 62109-2)
- DC coils, with only 700 mW holding power
- Reinforced insulation between coil and contacts
- Suitable for use at ambient temperatures up to 85 °C
- Thermal current up to 40 A
- Meets the EN 60335-1 requirements of resistance to heat and fire (GWIT 775 °C and GWFI 850 °C)
- Compliant with IEC 62955 requirements for short circuit capability
- Mirror contact (type 68.55) according to EN 60947-4-1 Annex F
- Cadmium free contact materials

For outline drawing see page 9

**Contact specification**

Contact configuration		4 NO	4 NO/1 NC
Contact gap	mm	$\geq 3.6$	$\geq 3.6$
Rated current/ Maximum peak current (for 1 ms)	A	32/300	32/300
Feedback contact configuration		—	1 NC
Rated current NC contact	A	—	3
Rated voltage/ Maximum switching voltage	V AC	250/400	250/400
Rated load AC1/AC7a (per pole)	VA	8000	8000
Rated load AC15 (per pole @ 230 V AC)	VA	1840	1840
Single-phase motor rating (230 V AC)	kW	2.2	2.2
Three-phase motor rating (480 V AC)	kW	11	11
Breaking capacity DC1: 24/110/220 V	A	32/4/1	32/4/1
Minimum switching load NO contacts	mW (V/mA)	1000 (10/10)	1000 (10/10)
Minimum switching load NC contacts	mW (V/mA)	—	100 (10/5)
Standard NO contact material		AgSnO <sub>2</sub>	AgSnO <sub>2</sub>
Standard NC feedback contact material		—	AgNi + Au

**Coil specification**

Nominal voltage (U <sub>N</sub> )	V DC	12 - 24	12 - 24
Rated power	W	2.9	2.9
Operating range (-40...+70°C)	DC	(0.90 ... 1.1)U <sub>N</sub>	(0.90 ... 1.1)U <sub>N</sub>
Energy-saving mode (-40...+85)°C			
Operating range for 1 s		(0.95...2.5)U <sub>N</sub>	(0.95...2.5)U <sub>N</sub>
Holding voltage	DC	0.5 U <sub>N</sub>	0.5 U <sub>N</sub>
Minimum holding power	W	0.7	0.7
Must drop-out voltage	DC	0.05 U <sub>N</sub>	0.05 U <sub>N</sub>

**Technical data**

Mechanical life	cycles	1 · 10 <sup>6</sup>	1 · 10 <sup>6</sup>
Electrical life at rated load AC7a	cycles	50 · 10 <sup>3</sup>	50 · 10 <sup>3</sup>
Operate/release time	ms	25/3	25/6
Ambient temperature range (energy-saving mode)	°C	-40...+70 (-40...+85)	-40...+70 (-40...+85)
Environmental protection		RT II	RT II

**Approvals** (according to type)

**NEW 68.54-4300**



- 4 NO
- Contact gap 3.6 mm
- PCB mount

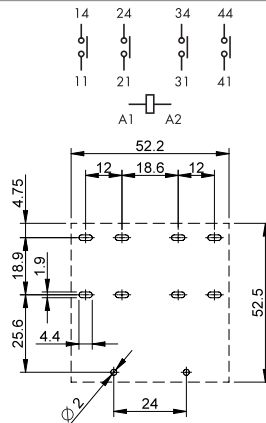

Copper side view

**NEW 68.55-4300**



- 4 NO/1 NC
- Contact gap 3.6 mm
- PCB mount

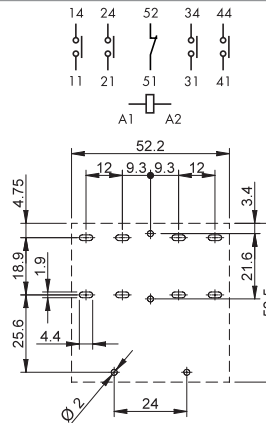

Copper side view

## Ordering information

Example: 68 series, power relay for printed circuit, 2 NO contacts, 12 V DC coil.

A

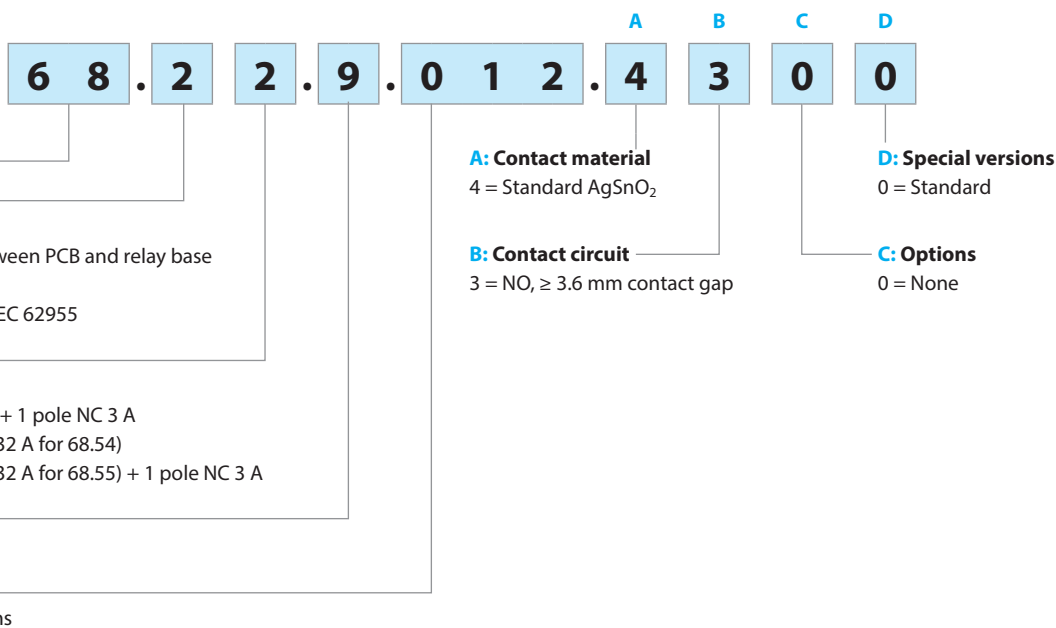

## Technical data

<b>Insulation according to EN 61810-1</b>		<b>68.22</b>	<b>68.23/24/25/54/55</b>
Nominal voltage of supply system	V AC	230/400 3-phase	230/400 3-phase
Rated insulation voltage	V AC	400	400
Pollution degree		3	3
Overvoltage category		III	III
Rated impulse voltage	kV (1.2/50 μs)	4	4
<b>Insulation between coil and contact set</b>			
Type of Insulation		Reinforced	Reinforced
Dielectric strength	V AC	5000	5000
<b>Insulation between adjacent contacts</b>			
Type of Insulation		Reinforced	Basic
Dielectric strength	V AC	4000	2500
<b>Insulation between open contacts</b>			
Type of disconnection		Full-disconnection	Full-disconnection
Dielectric strength	V AC	2500	2500
<b>Insulation between coil terminals</b>			
Rated impulse voltage (surge) differential mode (according to EN 61000-4-5)	kV (1.2/50 μs)	4	
<b>Other data</b>			
Bounce time: NO/NC	ms	2/2	
Vibration resistance (10...150)Hz: NO	g	9	
Shock resistance	g	30	
Power lost to the environment	without contact current	W	2.9
	with rated current	W	13
Test procedure		B (single mounting)	
Recommended distance between relays mounted on PCB in case of group mounting	mm	≥ 20	

## Contact specification

**F 68 - Electrical life v contact current (68.22/23)**

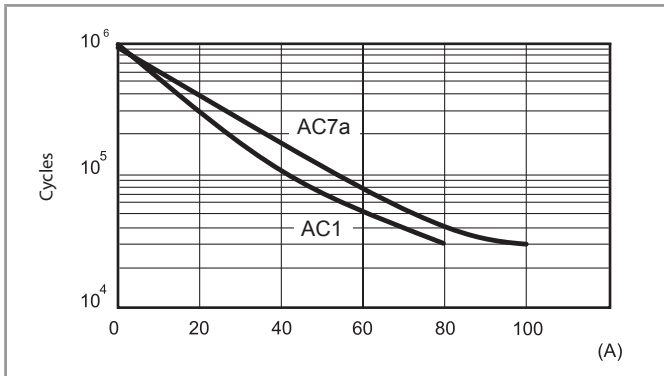

**NOTE:** For ambient temperatures between 70 and 85 °C, the electrical life is reduced by 30%.

**F 68-1 - Electrical life v contact current (AC1/AC7a load) - (68.24/25/54/55)**

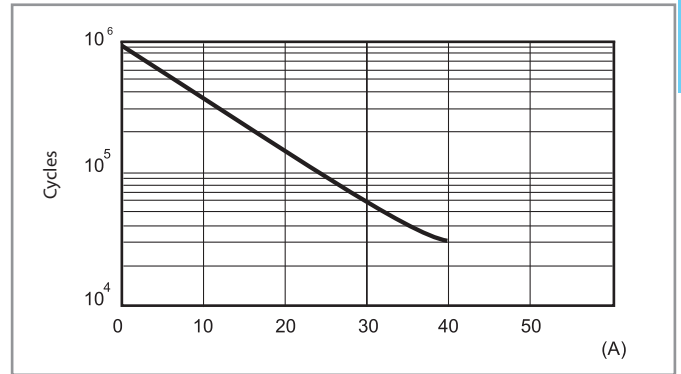

**H 68-1 - Maximum DC breaking capacity (68.22/23)**

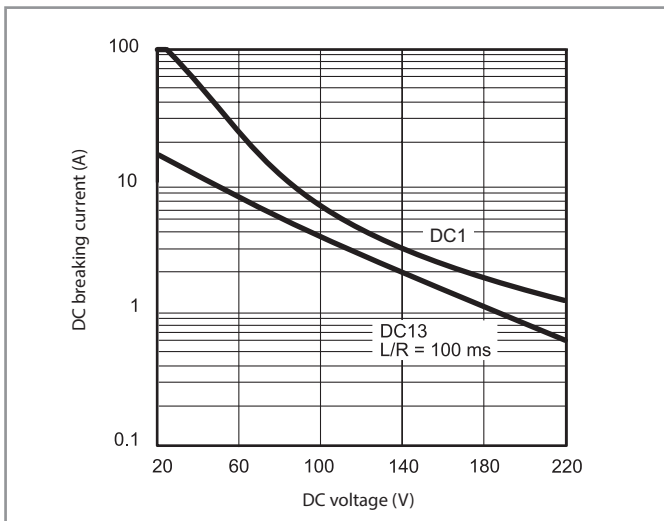

When switching a resistive (DC1) or inductive (DC13) load having voltage and current values under the corresponding curve, an electrical life of > 30000 cycles can be expected.

**H 68-2 - Maximum DC breaking capacity (68.24/25/54/55)**

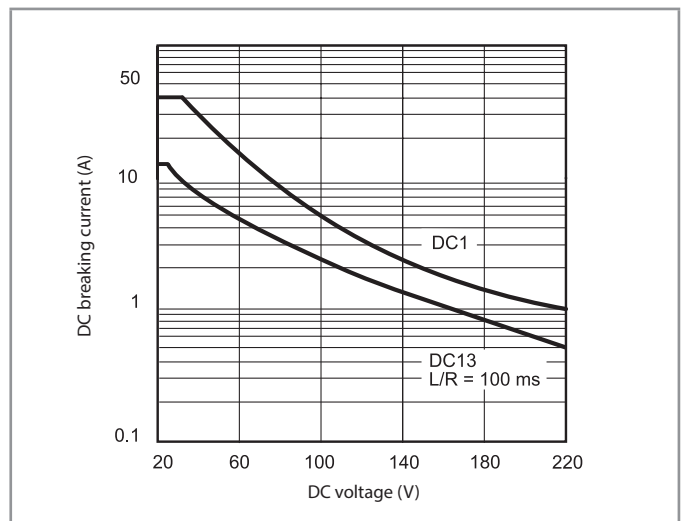

When switching a resistive (DC1) or inductive (DC13) load having voltage and current values under the corresponding curve, an electrical life of > 30000 cycles can be expected.

**NOTE:** The heating and electrical endurance tests have been performed on relays soldered on PC boards having the following characteristics: double side, copper thickness >105 µm, contact tracks width 40 to 45 mm, total cross section about 10 mm<sup>2</sup>

## Short circuit technical data

Short circuit protection according to EN 60947-4-1		68.22/23		68.24/25/54/55	
Rated conditional short circuit current	kA	5		5	3
Back-up fuse for motor load	A	63 aM		40 aM	50 gG
Short circuit capability according to IEC 62955		68.54/55			
Test sequence E: 9.11.2.3 a) + 9.11.2.3 c) 230 /400 V AC	$I_N$	32 A			
	$I_{NC} / I_{DC}$	3 kA			
	$I_p$	1.85 kA			
	$I^2t$	4.5 kA <sup>2</sup> s			
Test sequence F: 9.11.2.3 b) + 9.11.2.2 230 /400 V AC	$I_m$	500 A			

## Coil specifications

### DC coil data

Nominal voltage $U_N$ V	Coil code	Operating range (@ 70 °C max)		Holding voltage $U_h$ V	Resistance R $\Omega$	Rated coil consumption I at $U_N$ $I_N$ mA
		$U_{min}$ V	$U_{max}$ V			
12	9.012	10.8	13.2	6.0	50	240
24	9.024	21.6	26.4	12.0	200	120

#### R 68-1 - Operating range v ambient temperature, with standard (continuous) coil energization (-40...+70)°C

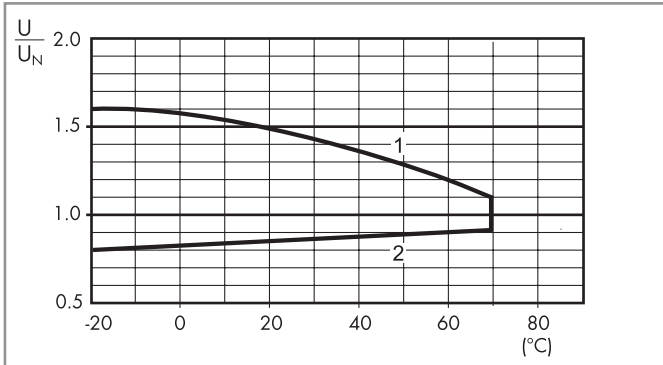

- 1 - Max. permitted coil voltage.  
2 - Min. pick-up voltage with coil at ambient temperature.

#### R 68-2 - Operating range v ambient temperature, in energy saving mode (-40...+85)°C

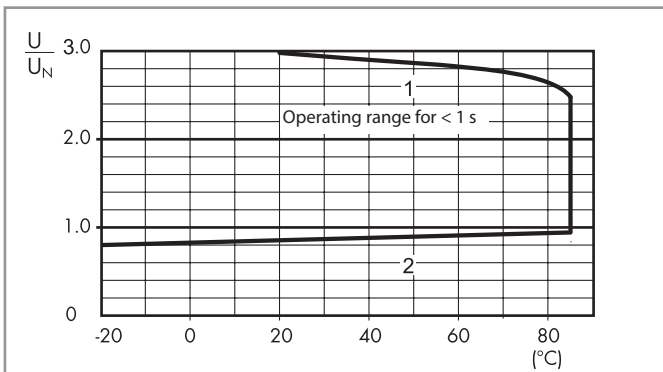

- 1 - Max. permitted coil voltage.  
2 - Min. pick-up voltage with coil at ambient temperature.

#### Energy saving mode

In some applications, such as photovoltaic inverters, it may be necessary to minimize the overall relay power dissipation and to permit use at higher ambient temperature levels (up to 85 °C). This can be achieved by initially applying a coil voltage within the Energy saving mode Operating range (see diagram to the left) and then rapidly (< 1 s) reducing the coil voltage to a level within the Holding voltage range. The lower the Holding voltage, the lower is the continuous power dissipation of the coil (0.7 W minimum).

Coil voltages as high as 2.5  $U_N$  may be used, when necessary, to reduce the contact operate time.

Outline drawings

Type 68.22

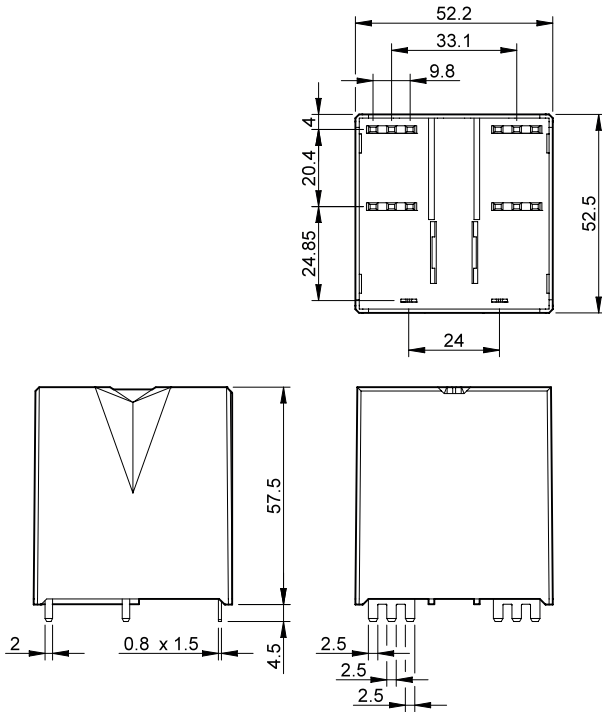

Type 68.23

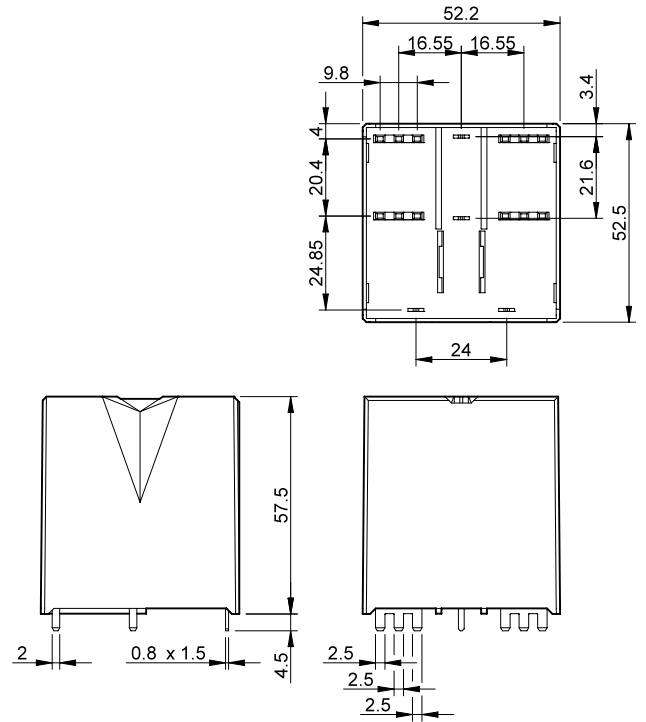

Type 68.24/54

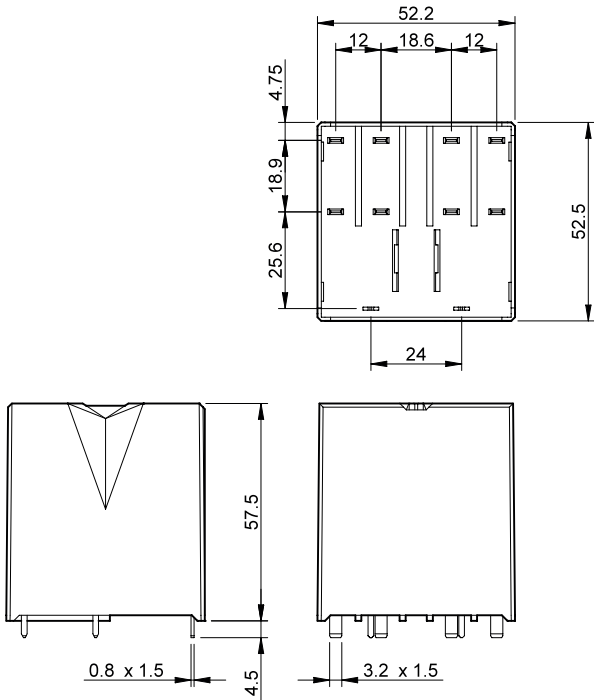

Type 68.25/55

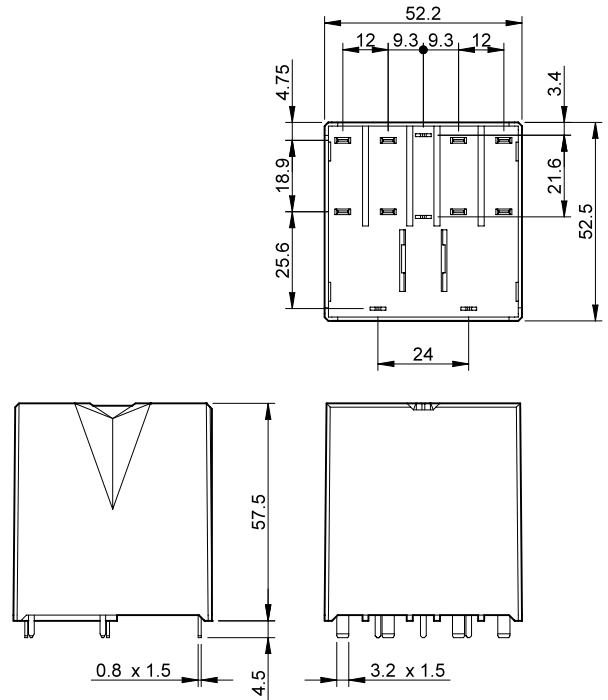





# Bistable relay 8 A



Power  
Plants



Panels for  
electrical  
distribution



Control  
panels



Automatic  
warehouses





**Bistable relay for control and signaling**  
**RB.14 35 mm rail (EN 60715) mount**  
**RB.22 11 pin socket type 90.21 mount**

- 2 or 4 pole changeover contact
- DC voltage
- 2 coil type
- SET and RESET signals
- LED command status indication
- Cadmium Free contact material

RB.14/22  
Screw terminal



**RB.14**

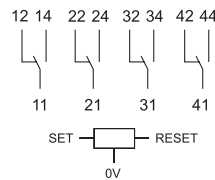

**RB.22**

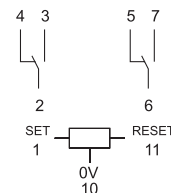

For outline drawings see page 7

<b>Contact specification</b>			
Contact configuration		4 CO (4PDT)	2 CO (DPDT)
Rated current/Maximum peak current	A	8/15	8/15
Rated voltage/ Maximum switching voltage	V AC	250/400	250/400
Rated load AC1	VA	2000	2000
Rated load AC15	VA	350	350
Single phase motor rating (230 V AC)	kW	0.37	0.37
Breaking capacity DC1: 24/110/220 V	A	8/0.3/0.12	8/0.3/0.12
Minimum switching load	mW (V/mA)	300 (5/5)	300 (5/5)
Standard contact material		AgSnO <sub>2</sub>	AgSnO <sub>2</sub>
<b>Coil specification</b>			
Nominal voltage (U <sub>N</sub> )	V DC	24 - 110...125 - 220...250	24 - 110...125 - 220...250
Rated power DC	W	7	4
Operating range	V DC	(0.8...1.1)U <sub>N</sub>	(0.8...1.1)U <sub>N</sub>
<b>Technical data</b>			
Mechanical life DC	cycles	2 · 10 <sup>6</sup>	2 · 10 <sup>6</sup>
Electrical life at rated load AC1	cycles	100 · 10 <sup>3</sup>	100 · 10 <sup>3</sup>
Operate/release time SET/RESET	ms	10/5	10/5
Insulation between coil and contacts (1.2/50 μs)	kV	6 (8 mm)	4 (8 mm)
Dielectric strength between open contacts	V AC	1000	1000
Ambient temperature range	°C	-40...+55	-40...+55
Protection category		IP 20	IP 20
<b>Approvals relay</b> (according to type)		<b>CE UK EAC ENEC</b>	

## Ordering information

Example: RB series, bistable relay, 4 CO, 125 V DC coil, 35 mm rail (EN 60715) mount.

A

**R B . 1 4 . 9 . 1 2 5 . 0 0 0 0**

**Series**

**Type**  
1 = Modular version

**No. of poles**  
4 = 4 CO

**Coil version**  
9 = DC

**Coil voltage**  
024 = 24 V DC  
125 = 110...125 V DC  
250 = 220...250 V DC

**Options**  
0000 = Modular version 35 mm rail (EN 60715)

**Codes/supply voltages**  
RB.14.9.024.0000  
RB.14.9.125.0000  
RB.14.9.250.0000

Example: RB series, bistable relay, 2 CO, 125 V DC coil, 11 pin socket type 90.21 mount.

**R B . 2 2 . 9 . 1 2 5 . 9 0 2 1**

**Series**

**Type**  
2 = 11 pin socket type 90.21 mount

**No. of poles**  
2 = 2 CO

**Coil version**  
9 = DC

**Coil voltage**  
024 = 24 V DC  
125 = 110...125 V DC  
250 = 220...250 V DC

**Options**  
9021 = Version plug-in 90.21 socket  
0000 = Version relay only

**Codes/supply voltages**  
RB.22.9.024.0000  
RB.22.9.024.9021  
RB.22.9.125.0000  
RB.22.9.125.9021  
RB.22.9.250.0000  
RB.22.9.250.9021

## Technical data

### Insulation according to EN 61810-1

		2 CO	4 CO
Nominal voltage of supply system	V AC	230/400	230/400
Rated insulation voltage	V AC	250	250
Pollution degree		2	2

### Insulation between coil and contact set

Type of insulation		Reinforced (8 mm)	Reinforced (8 mm)
Overvoltage category		III	III
Rated impulse voltage	kV (1.2/50 μs)	4	6
Dielectric strength	V AC	2000	3000

### Insulation between adjacent contacts

Type of insulation		Basic	Basic
Overvoltage category		III	III
Rated impulse voltage	kV (1.2/50 μs)	4	4
Dielectric strength	V AC	2000	2500

### Insulation between open contacts

Type of disconnection		Micro-disconnection	Micro-disconnection
Dielectric strength	V AC/kV (1.2/50 μs)	1000/1.5	1000/1.5

### Insulation between coil terminals

Rated impulse voltage (surge) differential mode (according to EN 61000-4-5)	kV (1.2/50 μs)	2
---	----------------	---

### Other data

Bounce time: SET (NO) / RESET (NC)	ms	3/6
Vibration resistance (5...55)Hz: NO/NC	g	3/6
Shock resistance	g	15
Max cable length for push-button connection	m	100

### Terminals

		<b>Screw terminal</b>
		<b>Solid and stranded cable</b>
Max. wire size	mm <sup>2</sup>	1 x 2.5 / 2 x 1.5
	AWG	1 x 14 / 2 x 16

## Contact specification

### RB - Maximum DC1 breaking capacity

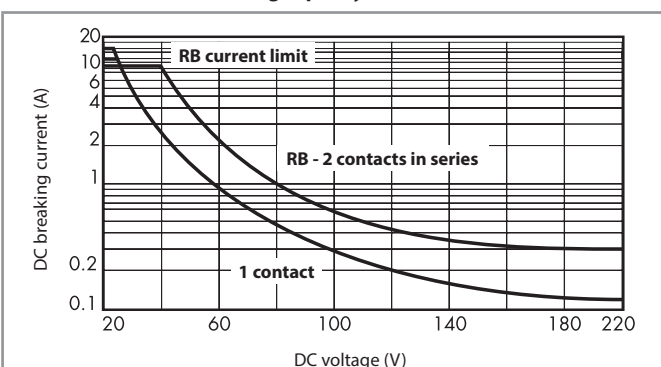

- When switching a resistive load (DC1) having voltage and current values under the curve, an electrical life of  $\geq 100 \cdot 10^3$  can be expected.
- In the case of DC13 loads, the connection of a diode in parallel with the load will permit a similar electrical life as for a DC1 load.  
Note: the release time for the load will be increased.

## Coil specifications - Type RB.14

### DC coil data

Nominal voltage $U_N$ V	Coil code	Operating range		Rated coil consumption I at $U_N$ mA	Rated power W
		$U_{min}$ V	$U_{max}$ V		
24	9.024	19.2	26.4	290	7
110...125	9.125	88	137.5	60	7
220...250	9.250	176	275	30	7

## Coil specifications - Type RB.22

### DC coil data

Nominal voltage $U_N$ V	Coil code	Operating range		Rated coil consumption I at $U_N$ mA	Rated power W
		$U_{min}$ V	$U_{max}$ V		
24	9.024	19.2	26.4	170	4
110...125	9.125	88	137.5	35	4
220...250	9.250	176	275	18	4

## Wiring diagrams

A

### Type RB.14

Connection for only local push-buttons enable  
EN = Enable - Positive voltage  
0V = Negative voltage

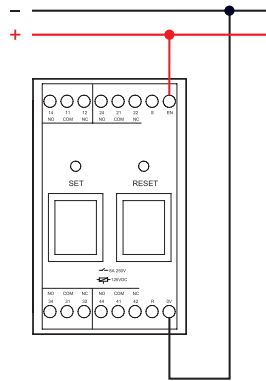

### Type RB.14

Connection for remote push-buttons enable

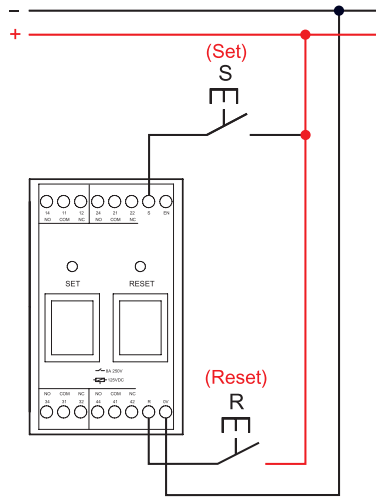

### Type RB.14

Connection for local and remote push-buttons enable

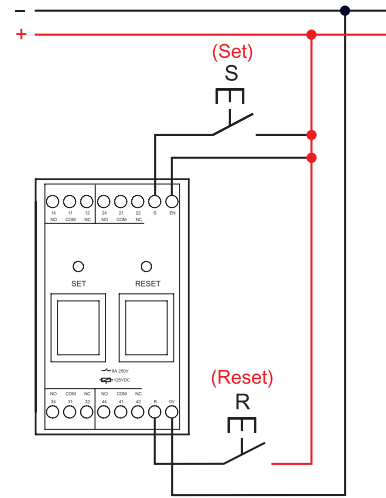

### Type RB.22

Connection for only local push-buttons enable  
EN = Enable - Positive voltage  
0V = Negative voltage

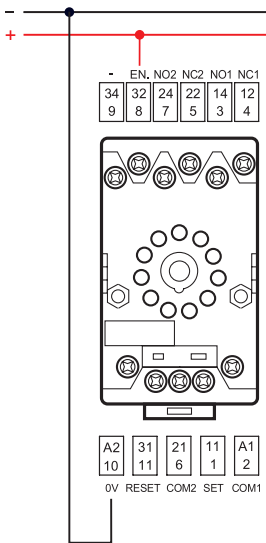

### Type RB.22

Connection for remote push-buttons enable

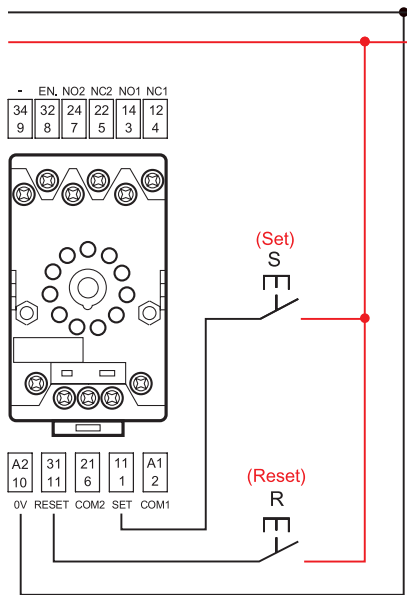

### Type RB.22

Connection for local and remote push-buttons enable

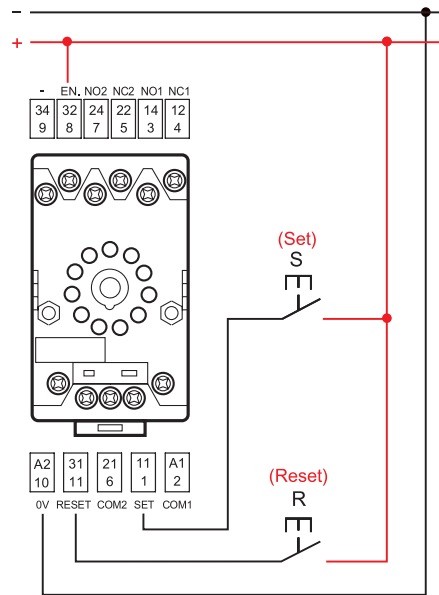

## Functions

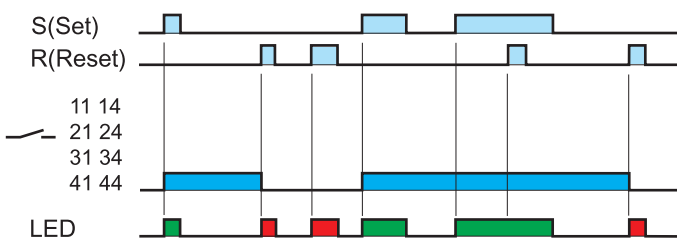

Outline drawing

Type RB.14  
Screw terminal

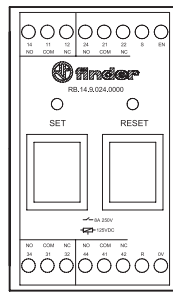
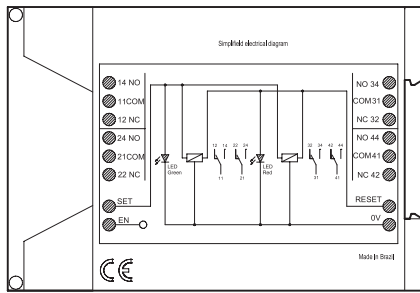
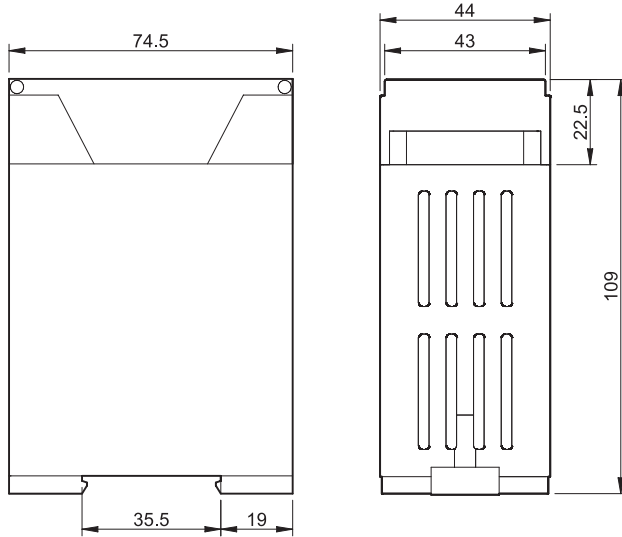

Type RB.22  
Screw terminal

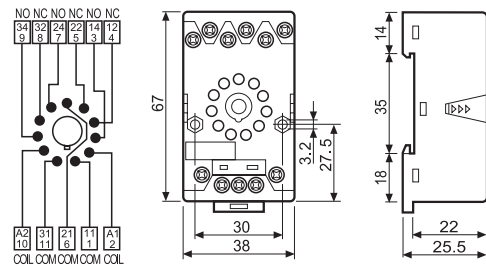
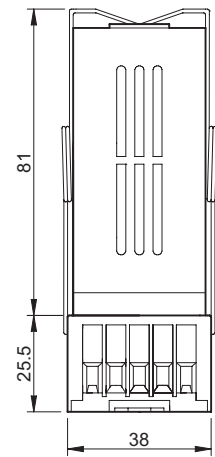
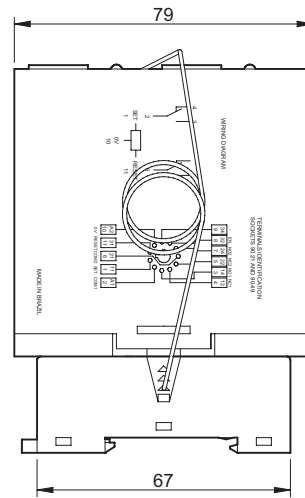
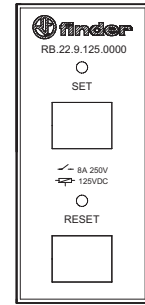
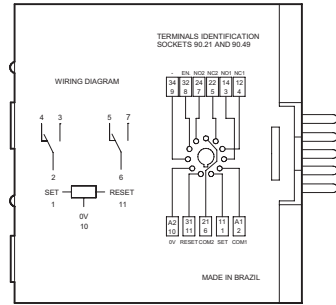





# Fast relay module 8 A



Power  
Plants



Panels for  
electrical  
distribution



Control  
panels



Control and  
management of  
electric power

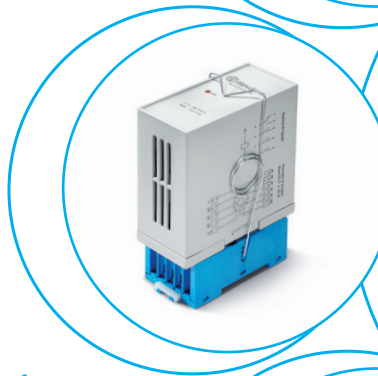



**Fast relay module**

**RR.14 35 mm rail (EN 60715) mount**  
**RR.24 11 pin socket type 90.21 mount**

- 4 pole changeover or 3 NO + 1 changeover contacts
- DC voltage
- Operate time  $\leq 3$  ms
- LED command status indication
- 35 mm rail (EN 60715) mount
- 11 pin socket type 90.21 mount

RR.14/24  
Screw terminal



**RR.14**

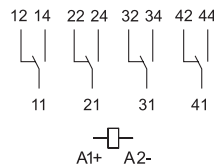

**RR.24**

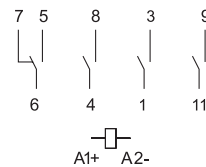

For outline drawings see page 7

<b>Contact specification</b>			
Contact configuration		4 CO (4PDT)	3 NO (SPST-NO) + 1 CO (SPDT)
Rated current/Maximum peak current	A	8/15	8/15
Rated voltage/ Maximum switching voltage	V AC	250/400	250/400
Rated load AC1	VA	2000	2000
Rated load AC15	VA	400	400
Single phase motor rating (230 V AC)	kW	0.3	0.3
Breaking capacity DC1: 24/110/220 V	A	8/0.3/0.12	8/0.3/0.12
Minimum switching load	mW (V/mA)	300 (5/5)	300 (5/5)
Standard contact material		AgCdO	AgCdO
<b>Coil specification</b>			
Nominal voltage ( $U_N$ )	V DC	24 - 48 - 110...125 - 220...250	24 - 110...125 - 220...250
Rated power DC	W	< 5	< 3
Operating range	V DC	(0.8...1.1) $U_N$	(0.8...1.1) $U_N$
<b>Technical data</b>			
Mechanical life DC	cycles	$10 \cdot 10^6$	$10 \cdot 10^6$
Electrical life at rated load AC1	cycles	$100 \cdot 10^3$	$100 \cdot 10^3$
Operate/release time	ms	2.9/2.5	3/5
Insulation between coil and contacts (1.2/50 $\mu$ s)	kV	6 (8 mm)	4 (8 mm)
Dielectric strength between open contacts	V AC	1000	1000
Ambient temperature range	$^{\circ}$ C	-40...+55	-40...+55
Protection category		IP 20	IP 20
<b>Approvals relay</b> (according to type)		<b>CE UK EAC</b>	

## Ordering information

Example: RR series, fast relay module, 4 CO, 125 V DC coil, 35 mm rail (EN 60715) mount.

A

RR.14.9.125.0000

**Series**

**Type**  
1 = Modular version

**No. of poles**  
4 = 4 CO

**Coil version**  
9 = DC

**Coil voltage**  
024 = 24 V DC  
048 = 48 V DC  
125 = 110...125 V DC  
220 = 220 V DC  
250 = 250 V DC

**Options**  
0000 = Modular version 35 mm rail (EN 60715)

**Codes/supply voltages**  
RR.14.9.024.0000  
RR.14.9.048.0000  
RR.14.9.125.0000  
RR.14.9.220.0000  
RR.14.9.250.0000

Example: RR series, fast relay module, 3 NO + 1 CO, 125 V DC coil, 11 pin socket type 90.21 mount.

RR.24.9.125.9021

**Series**

**Type**  
2 = Plug-in version

**No. of poles**  
4 = 3 NO + 1 CO

**Coil version**  
9 = DC

**Coil voltage**  
024 = 24 V DC  
125 = 110...125 V DC  
250 = 220...250 V DC

**Options**  
9021 = Relay + 90.21 sockets  
0000 = Only Relay

**Codes/supply voltages**  
RR.24.9.024.0000  
RR.24.9.024.9021  
RR.24.9.125.0000  
RR.24.9.125.9021  
RR.24.9.250.0000  
RR.24.9.250.9021

## Technical data

Insulation according to EN 61810-1		RR.14	RR.24
		4 CO	3 NO + 1 CO
Nominal voltage of supply system	V AC	230/400	230/400
Rated insulation voltage	V AC	250	250
Pollution degree		2	2
<b>Insulation between coil and contact set</b>			
Type of insulation		Reinforced (8 mm)	Reinforced (8 mm)
Overvoltage category		III	III
Rated impulse voltage	kV (1.2/50 µs)	6	4
Dielectric strength	V AC	3500	2000
<b>Insulation between adjacent contacts</b>			
Type of insulation		Basic	Basic
Overvoltage category		II	II
Rated impulse voltage	kV (1.2/50 µs)	2.5	2.5
Dielectric strength	V AC	2000	2000
<b>Insulation between open contacts</b>			
Type of disconnection		Micro-disconnection	Micro-disconnection
Dielectric strength	V AC/kV (1.2/50 µs)	1000/1.5	1000/1.5
<b>Insulation between coil terminals</b>			
Rated impulse voltage (surge) differential mode (according to EN 61000-4-5)	kV (1.2/50 µs)	2	
<b>Other data</b>			
Bounce time: NO/NC	ms	1.3/5.1	
Vibration resistance (5...55)Hz: NO/NC	g	15/3	
Shock resistance	g	13	
<b>Terminals</b>		<b>Screw terminal</b>	
		<b>Solid and stranded cable</b>	
Max. wire size	mm <sup>2</sup>	1 x 2.5 / 2 x 1.5	
	AWG	1 x 14 / 2 x 16	

A

## Contact specification

RR - Electrical life (AC) v contact current

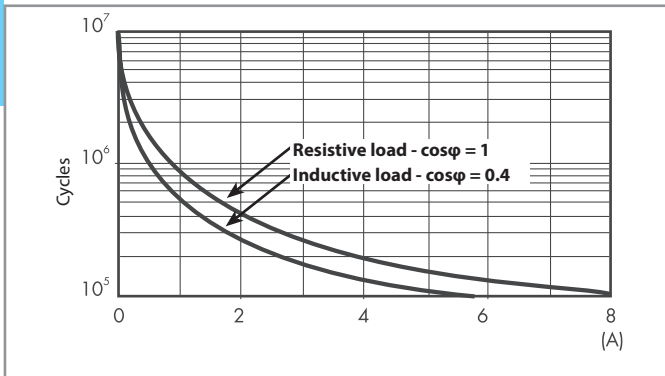

RR - Maximum DC1 breaking capacity

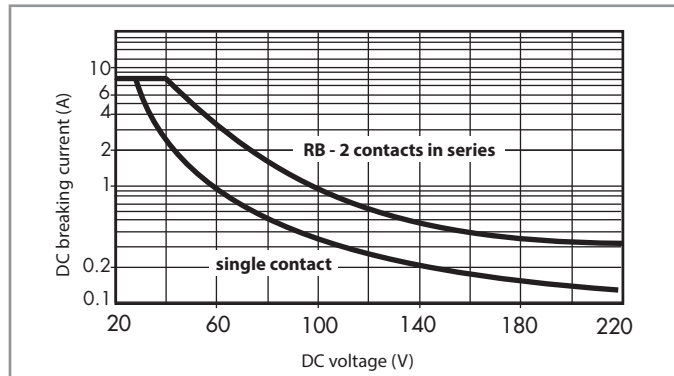

- When switching a resistive load (DC1) having voltage and current values under the curve, an electrical life of  $\geq 100 \cdot 10^3$  can be expected.
- In the case of DC13 loads, the connection of a diode in parallel with the load will permit a similar electrical life as for a DC1 load.  
Note: the release time for the load will be increased.

## Coil specifications - Type RR.14

DC coil data

Nominal voltage	Coil code	Operating range		Holding voltage	Must drop-out voltage	Rated power	Rated coil consumption
		$U_{min}$	$U_{max}$				
$U_N$		V	V	V	V	W	I at $U_N$
V		V	V	V	V	W	mA
24	9.024	19.2	26.4	15	2.8	4.8	200
48	9.048	38.4	52.8	30	3	3.8	80
110...125	9.125	88	137.5	80	12	3.8	30
220	9.220	176	242	150	20	4.0	18
250	9.250	200	275	160	22	3.8	15

## Coil specifications - Type RR.24

DC coil data

Nominal voltage	Coil code	Operating range		Holding voltage	Must drop-out voltage	Rated power	Rated coil consumption
		$U_{min}$	$U_{max}$				
$U_N$		V	V	V	V	W	I at $U_N$
V		V	V	V	V	W	mA
24	9.024	19.2	26.4	14	2.4	2.9	120
110...125	9.125	88	137.5	80	12	2.5	20
220...250	9.250	176	275	150	20	1.8	8

Outline drawing

Type RR.14  
Screw terminal

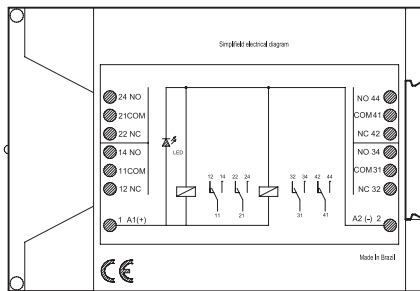
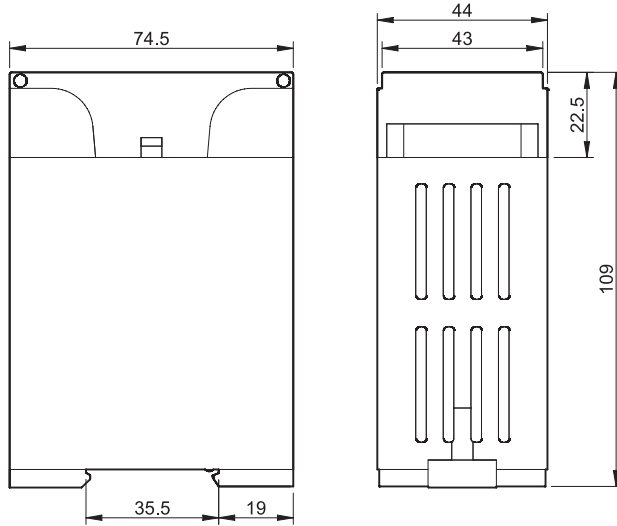

Type RR.24  
Screw terminal

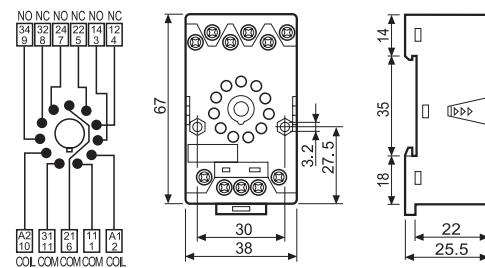
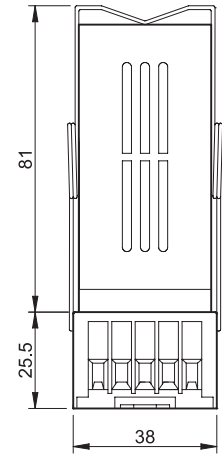
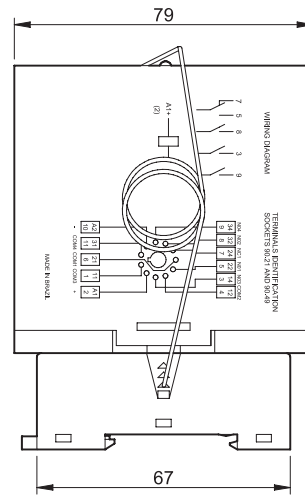
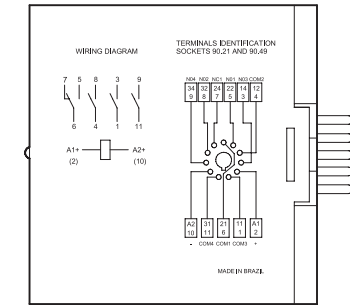





# Coil indication and EMC suppression modules 90/92/94/95/96/97 series



Panels for electrical  
distribution



Control panels



Carousel  
warehouses



Escalators



Road / tunnel  
lighting



Hoists and cranes





99.02



Approvals (according to type):

Diagrams	Code	Functions
	99.02.9.024.99 99.02.9.060.99 99.02.9.220.99	<b>Green LED + diode module (standard polarity) - ATEX compliant (Ex ec)*</b> Recovery diode modules + LED are used for DC only. The reverse voltage peaks of the coil are short circuited by the recovery diode (positive to terminal A1). The release time increases by an approximate factor from 3 to 5. If an increase of the release time is undesirable use a Varistor or RC module. The LED indicator lights up when the coil is energized.
	99.02.0.024.98 99.02.0.060.98 99.02.0.230.98	<b>Green LED + Varistor module - ATEX compliant (Ex ec)*</b> LED modules + Varistor are used for both AC and DC coils. The reverse voltage peaks of the relay coil are limited by the Varistor to approximately 2.5 times the nominal voltage of the supply. When using DC coils it is essential that positive is connected to terminal A1. The relay release time increases insignificantly.
	99.02.0.024.59 99.02.0.060.59 99.02.0.230.59	<b>Green LED module - ATEX compliant (Ex ec)*</b> LED modules are used for AC and DC. The LED indicator lights up when the coil is energized. When using DC it is essential that positive is connected to terminal A1.
	99.02.3.000.00	<b>Diode module (standard polarity)</b> Recovery diode modules are used for DC only. The reverse voltage peaks of the coil are short circuited by the recovery diode (positive to terminal A1). The release time increases by an approximate factor from 3 to 5. If an increase of the release time is undesirable use a Varistor or RC module.
	99.02.0.024.09 99.02.0.060.09 99.02.0.230.09	<b>RC module</b> RC circuit modules are used for AC and DC coils. The reverse voltage peaks of the coil are limited by the RC module to approximately 2.5 times the nominal voltage of the supply. The relay release time increases insignificantly.
	99.02.8.230.07	<b>Residual current bypass module</b> Bypass modules are advisable if 110 or 230 V AC relays show any tendency to fail to release. Failure to release can be caused by residual currents from AC proximity switches or inductive coupling caused through long parallel lying AC control lines. Additional 0.9 W power dissipation.

Voltage-current characteristic when switching a resistive load (fig. 1).

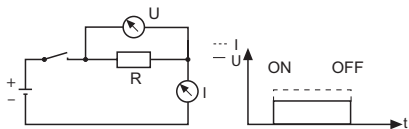

Voltage-current characteristic when switching a relay coil (fig. 2).

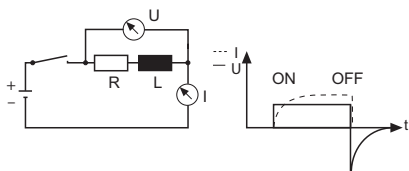

**Switching Relay Coils.**

When switching a resistive load, the current follows the phase of the voltage directly (Fig 1).

When switching relay coils the current and voltage waveforms are different due to the inductive nature of the coil (Fig 2). A brief explanation of this mechanism is as follows.

On energising the coil, the build up of the magnetic field gives rise to counter electromotive forces which in turn delay the rise in coil current. On de-energisation, the sudden interruption of the coil current causes a sudden collapse of the magnetic field, which in turn induces a high voltage of reverse polarity across the coil. This reverse polarity voltage peak can reach a value typically 15 times higher than the supply voltage, and as a consequence can disturb or destroy electronic devices.

To counteract this potentially damaging effect, relays coils can be suppressed with a Diode, a Varistor (voltage dependent resistor) or a RC (resistor/capacitor) module – dependent on the operating voltage. (See above for descriptions of the various Modules available.)

Whilst the above description is based on the working of a DC coil, the reverse polarity voltage peak on de-energisation applies similarly to AC coils. However, when energising AC coils there will also be a coil inrush current of 1.3 to 1.7 times the nominal coil current – dependent on coil size. If coils are fed via a transformer (and particularly if several are energised at the same time) then this may need to be taken into account when calculating the VA rating of the transformer.

\* 99.02 modules are also Atex certified to be used with 58 Atex interface.



# Relay interface modules 0.1 - 2 - 3 - 5 - 6 - 8 - 16 A



Bottling plant



Packaging machines



Control panels



Traffic light controls



Vending machines



Programmable controllers





Panels for electrical distribution

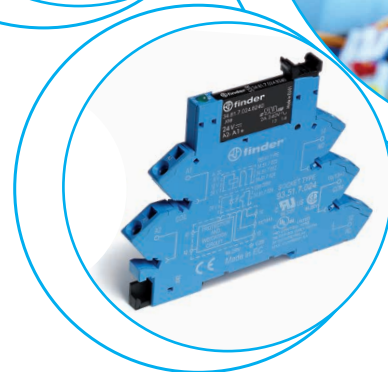
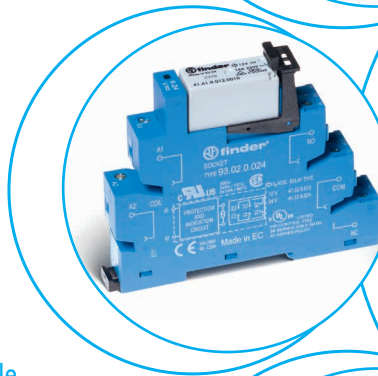
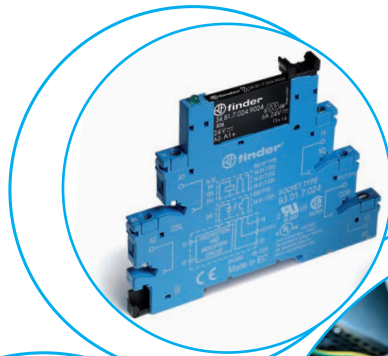

Labelling machines



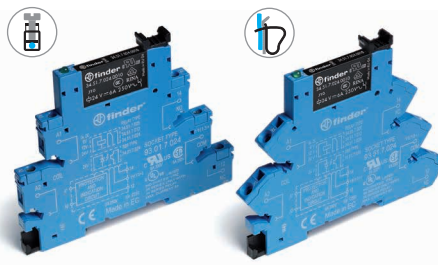
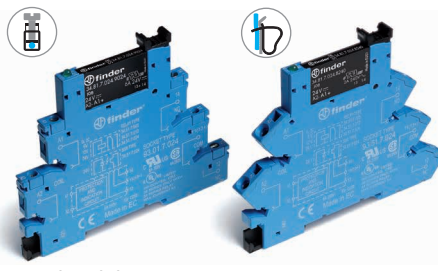
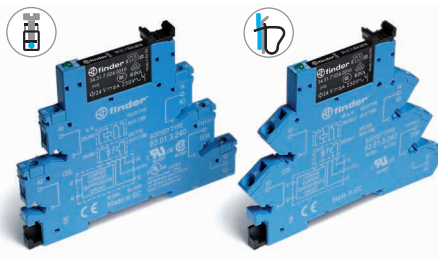
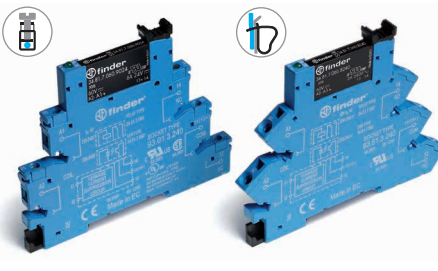

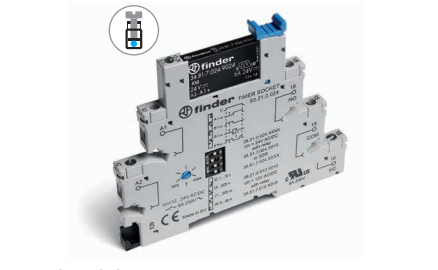
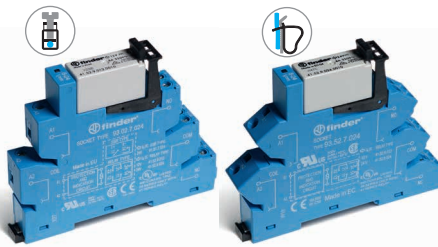
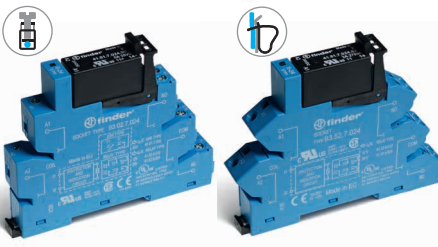
<p><b>Common features</b></p> <ul style="list-style-type: none"> <li>Instant ejection of relay by plastic retaining clip</li> <li>Integral coil indication and protection circuit</li> <li>35 mm rail (EN 60715) mounting</li> </ul>	<p><b>EMR</b> <b>Electromechanical Relays</b></p>	<p><b>SSR</b> <b>Solid State Relays</b></p>
<p><b>6.2 mm wide</b></p> <ul style="list-style-type: none"> <li>EMR - DC, AC or AC/DC coil versions</li> <li>SSR - DC or AC/DC input versions</li> <li>Screw and Screwless terminal options</li> </ul>	<p><b>38.51/38.61</b></p>  <p>• 1 CO - 6 A/250 V AC</p> <p style="text-align: right;">Page 1</p>	<p><b>38.81/38.91</b></p>  <p>• Single solid state output: Options 0.1 A/48 V DC, 6 A/24 V DC, 2 A/240 V AC</p> <ul style="list-style-type: none"> <li>Silent, high speed switching</li> <li>Long electrical life</li> </ul> <p style="text-align: right;">Page 2</p>
<p><b>6.2 mm wide</b></p> <ul style="list-style-type: none"> <li>Special coil/input leakage current suppression types</li> <li>EMR - AC or AC/DC coil versions</li> <li>SSR - AC or AC/DC input versions</li> <li>Screw and Screwless terminal options</li> </ul>	<p><b>38.51.3... - 38.61.3...</b></p>  <p>• 1 CO - 6 A/250 V AC</p> <p style="text-align: right;">Page 1</p>	<p><b>38.81.3... - 38.91.3...</b></p>  <p>• Single solid state output: Options 0.1 A/48 V DC, 6 A/24 V DC, 2 A/240 V AC</p> <ul style="list-style-type: none"> <li>Silent, high speed switching</li> <li>Long electrical life</li> </ul> <p style="text-align: right;">Page 2</p>
<p><b>6.2 mm wide</b></p> <ul style="list-style-type: none"> <li>Timed Interface module</li> <li>4 functions &amp; 4 time scales 0.1 s...6 h</li> <li>EMR - AC/DC (12 or 24 V) supply versions</li> <li>SSR - AC/DC (24 V) supply</li> <li>Screw terminals</li> </ul>	<p><b>38.21</b></p>  <p>• 1 CO - 6 A/250 V AC</p> <p style="text-align: right;">Page 3</p>	<p><b>38.21...9024-8240</b></p>  <p>• Single solid state output: Options 6 A/24 V DC, 2 A/240 V AC</p> <ul style="list-style-type: none"> <li>Silent, high speed switching</li> <li>Long electrical life</li> </ul> <p style="text-align: right;">Page 3</p>
<p><b>14 mm wide</b></p> <ul style="list-style-type: none"> <li>2 pole 8 A or 1 pole 16 A</li> <li>EMR - DC or AC/DC coil versions</li> <li>SSR - DC input versions</li> <li>Screw and Screwless terminal options</li> </ul>	<p><b>38.01/38.52/38.11/38.62</b></p>  <p>• 1 CO - 16 A/250 V AC • 2 CO - 8 A/250 V AC</p> <p style="text-align: right;">Page 4</p>	<p><b>38.31/38.41</b></p>  <p>• Single solid state output: Options 5 A/24 V DC, 3 A/240 V AC</p> <ul style="list-style-type: none"> <li>Silent, high speed switching</li> <li>Long electrical life</li> </ul> <p style="text-align: right;">Page 5</p>

B





### 1 Pole - 6 A electromechanical relay interface modules, 6.2 mm wide.

#### Ideal interface for PLC and electronic systems

- Sensitive DC coil or AC/DC coil versions
- Integral coil indication and protection circuit
- Instant ejection of relay using plastic retaining clip
- UL Listing (certain relay/socket combinations)
- 35 mm rail (EN 60715) mounting

38.51/38.51.3  
Screw terminal

38.61/38.61.3  
Screwless terminal



\* Special version for max ambient temperature +70 °C.

For outline drawing see page 13



38.51/61

- 1 pole electromechanical relay
- Screw terminal and screwless terminal
- 35 mm rail (EN 60715) mounting

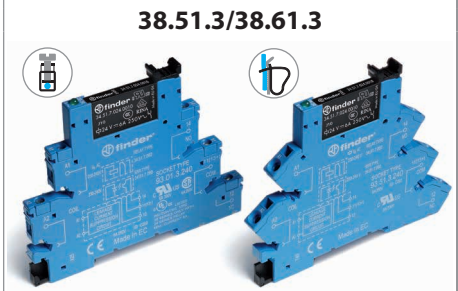

38.51.3/38.61.3

- Leakage current suppression
- 1 pole electromechanical relay
- Screw terminal and screwless terminal
- 35 mm rail (EN 60715) mounting

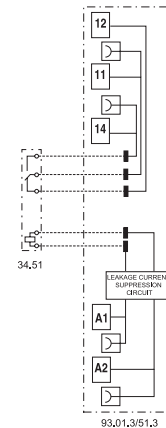
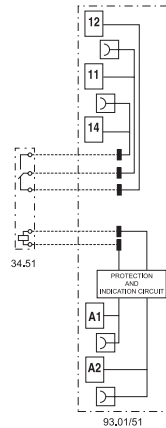

#### Contact specification

		38.51/61	38.51.3/38.61.3
Contact configuration		1 CO (SPDT)	1 CO (SPDT)
Rated current/ Maximum peak current	A	6/10	6/10
Rated voltage/ Maximum switching voltage	V AC	250/400	250/400
Rated load AC1	VA	1500	1500
Rated load AC15 (230 V AC)	VA	300	300
Single phase motor rating (230 V AC)	kW	0.185	0.185
Breaking capacity DC1: 24/110/220 V	A	6/0.2/0.12	6/0.2/0.12
Minimum switching load	mW (V/mA)	500 (12/10)	500 (12/10)
Standard contact material		AgNi	AgNi

#### Coil specification

		38.51/61	38.51.3/38.61.3
Nominal voltage (U <sub>N</sub> )	V AC/DC	12 - 24 - 48 - 60 - (110...125)	(110...125)
	V AC	(230...240)*	(230...240)
	V DC	6 - 12 - 24 - 48 - 60 - 220 (non polarized)	—
Rated power AC/DC	VA (50 Hz)/W	See page 9	1/1
Operating range	AC/DC	(0.8...1.1)U <sub>N</sub>	(94...138)V
	AC	(184...264)V	(184...264)V
	DC	(0.8...1.2)U <sub>N</sub>	—
Holding voltage	AC/DC	0.6 U <sub>N</sub> / 0.6 U <sub>N</sub>	0.6 U <sub>N</sub> / 0.6 U <sub>N</sub>
Must drop-out voltage	AC/DC	0.1 U <sub>N</sub> / 0.05 U <sub>N</sub>	44 V / 72 V

#### Technical data

Mechanical life AC/DC	cycles	10 · 10 <sup>6</sup>	10 · 10 <sup>6</sup>
Electrical life at rated load AC1	cycles	60 · 10 <sup>3</sup>	60 · 10 <sup>3</sup>
Operate/release time	ms	5/6	5/6
Insulation between coil and contacts (1.2/50 μs)	kV	6 (8 mm)	6 (8 mm)
Dielectric strength between open contacts	V AC	1000	1000
Ambient temperature range (U <sub>N</sub> ≤ 60 V / > 60 V)	°C	-40...+70 / -40...+55	-40...+55
Protection category		IP 20	IP 20

Approvals relay (according to type)



**Single output - solid state relay interface modules, 6.2 mm wide.**

**Ideal interface for PLC and electronic systems**

- DC, AC or AC/DC input versions
- Supplied with integral coil indication and protection circuit
- Silent, high switching speed and long electrical life
- Instant ejection of relay using plastic retaining clip
- UL Listing (certain relay/socket combinations)
- 35 mm rail (EN 60715) mounting

38.81/38.81.3  
Screw terminal

38.91/38.91.3  
Screwless terminal



**38.81/38.91**

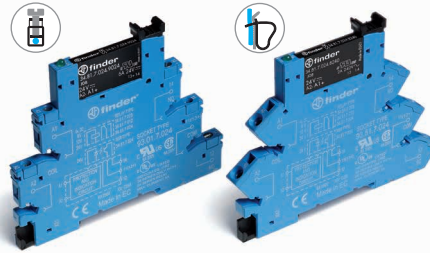

- AC or DC output switching
- SSR relay - DC input voltage
- Screw terminal and screwless terminal
- 35 mm rail (EN 60715) mounting

**38.81.3/38.91.3**

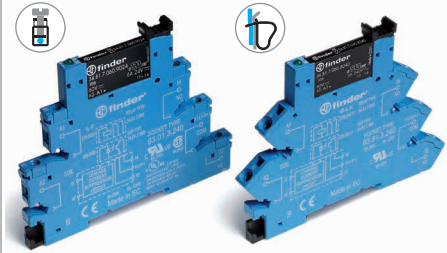

- Leakage current suppression
- AC or DC output
- SSR relay - AC or AC/DC input voltage
- Screw terminal and screwless terminal
- 35 mm rail (EN 60715) mounting

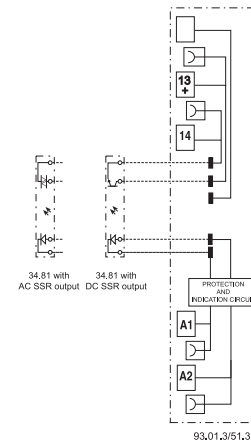
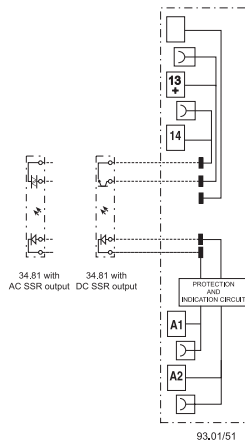

For outline drawing see page 13

**Output specification**

		1 NO (SPST-NO)			1 NO (SPST-NO)		
Contact configuration							
Rated current/ Maximum peak current (10 ms)	A	6/50	0.1/0.5	2/80	6/50	0.1/0.5	2/80
Rated voltage/ Maximum blocking voltage	V	24/33 DC	48/53 DC	240/— AC	24/33 DC	48/53 DC	240/— AC
Switching voltage range	V	(1.5...33)DC	(1.5...53)DC	(12...275)AC	(1.5...33)DC	(1.5...53)DC	(12...275)AC
Repetitive peak off-state voltage	V <sub>pk</sub>	—	—	800	—	—	800
Minimum switching current	mA	1	0.05	35	1	0.05	35
Max. "OFF-state" leakage current	mA	0.001	0.001	1.5	0.001	0.001	1.5
Max. "ON-state" voltage drop	V	0.4	1	1.6	0.4	1	1.6

**Input specification**

Nominal voltage (U <sub>N</sub> )	V AC	—			230...240		
	V DC	6 - 24 - 60			—		
	V AC/DC	(110...125) - (220...240)			110...125		
Operating range	V DC	See page 10			See page 10		
Control current	mA	See page 10			See page 10		
Release voltage	V DC	See page 10			See page 10		

**Technical data**

Operate/release time: ON/OFF (DC input)	ms	0.2/0.6	0.04/0.11	12/12	0.2/0.6	0.04/0.11	12/12
Dielectric strength between input/output	V AC	2500			2500		
Ambient temperature range	°C	-20...+55			-20...+55		
Environmental protection		IP20			IP20		

**Approvals relay** (according to type)



**Slim timed interface module, 6.2 mm wide.**

- 1 pole, 6 A - electromechanical relay**
- 1 output, 2 A DC or AC - solid state relay**

- Electromechanical or solid state output
- Multi-functions timer
- AC/DC supply
- 4 time scales from 0.1 s to 6 h
- Instant ejection of relay using plastic retaining clip
- 6.2 mm wide, 35 mm rail (EN 60715) mounting

38.21  
Screw terminal



**38.21**

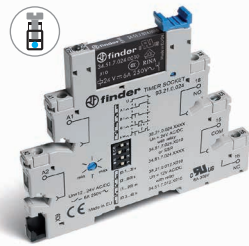

- 1 pole electromechanical output relay
- 12 or 24 V AC/DC supply
- Screw terminal
- 35 mm rail (EN 60715) mounting

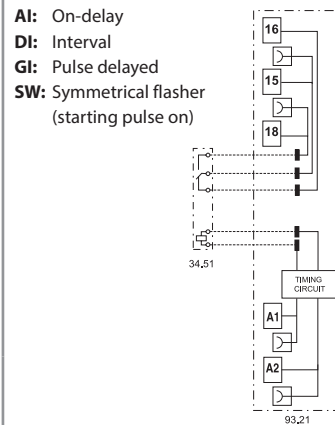

**38.21...9024-8240**

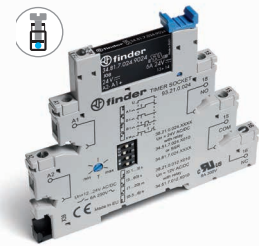

- DC or AC solid state output relays
- 24 V AC/DC supply voltage
- Screw terminal
- 35 mm rail (EN 60715) mounting

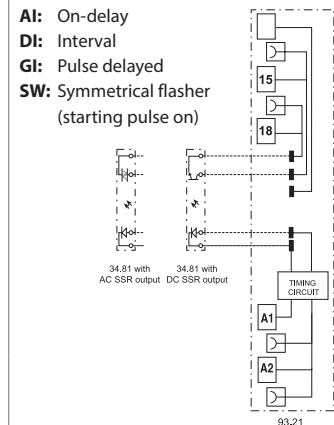

For outline drawing see page 13

**Contact specification**

Contact configuration		1 CO (SPDT)	—
Rated current/ Maximum peak current	A	6/10	—
Rated voltage/ Maximum switching voltage	V AC	250/400	—
Rated load AC1	VA	1500	—
Breaking capacity DC1: 24/110/220 V	A	6/0.2/0.12	—
Minimum switching load	mW (V/mA)	500 (12/10)	—
Standard contact material		AgNi	—

**Output specification**

			<b>DC output (...9024)</b>	<b>AC output (...8240)</b>
Output configuration		—	1 NO (SPST-NO)	1 NO (SPST-NO)
Rated current/Maximum peak current	A	—	6/50	2/80
Rated voltage/ Maximum blocking voltage	V	—	(24/33)DC	(240/—)AC
Switching voltage range	V	—	(1.5...33)DC	(12...275)AC
Repetitive peak off-state voltage	V <sub>pk</sub>	—	—	800
Minimum switching current	mA	—	1	35
Max. "OFF-state" leakage current	mA	—	0.001	1.5
Max. "ON-state" voltage drop	V	—	0.4	1.6

**Supply specification**

Nominal voltage (U <sub>N</sub> )	V AC (50/60 Hz)/DC	12 - 24	24
Rated power	VA/W	0.5	0.5
Operating range	AC	(0.8...1.1)U <sub>N</sub>	(0.8...1.1)U <sub>N</sub>
	DC	(0.8...1.1)U <sub>N</sub>	(0.8...1.1)U <sub>N</sub>

**Technical data**

Specified time range		(0.1...3)s, (3...60)s, (1...20)min, (0.3...6)h	
Repeatability	%	± 1	
Recovery time	ms	≤ 50	
Setting accuracy-full range	%	5%	
Ambient temperature	°C	-40...+70	-20...+55

Protection category

IP 20

**Approvals relay** (according to type)



**Electromechanical relay interface modules, 14 mm wide.**

**38.01 and 38.11 - 1 Pole 16 A**  
**38.52 and 38.62 - 2 Pole 8 A**

**Ideal interface for PLC and electronic systems**

- Sensitive DC coil or AC/DC coil versions
- Integral coil indication and protection circuit
- Instant ejection of relay using plastic retaining clip
- UL Listing (certain relay/socket combinations)
- 35 mm rail (EN 60715) mounting

B

38.01/52  
Screw terminal



38.11/62  
Screwless terminal



**38.01/38.11**

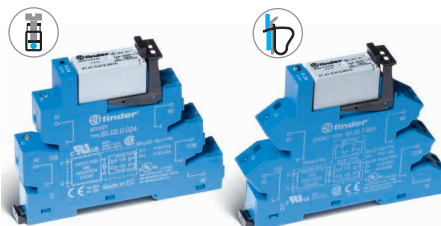

- Screw terminal and screwless terminal
- 1 pole electromechanical relay
- 35 mm rail (EN 60715) mounting

**38.52/38.62**

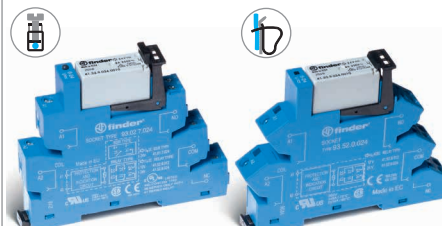

- Screw terminal and screwless terminal
- 2 pole electromechanical relay
- 35 mm rail (EN 60715) mounting

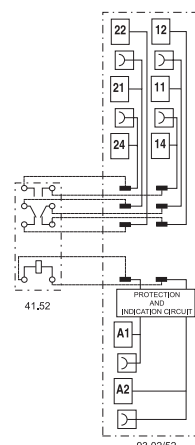
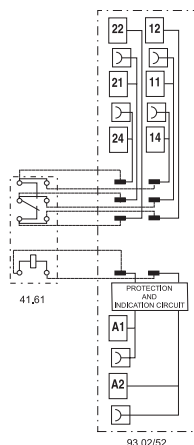

\* For currents > 10 A, contact terminals must be connected in parallel (21 with 11, 24 with 14, 22 with 12).

For outline drawing see page 13

**Contact specification**

Contact configuration		1 CO (SPDT)	2 CO (DPDT)
Rated current/Maximum peak current	A	16*/30	8/15
Rated voltage/Maximum switching voltage	V AC	250/400	250/400
Rated load AC1	VA	4000	2000
Rated load AC15 (230 V AC)	VA	750	400
Single phase motor rating (230 V AC)	kW	0.5	0.3
Breaking capacity DC1: 24/110/220 V	A	16/0.3/0.12	8/0.3/0.12
Minimum switching load	mW (V/mA)	300 (5/5)	300 (5/5)
Standard contact material		AgNi	AgNi

**Coil specification**

Nominal voltage (U <sub>N</sub> )	V AC/DC	24 - 60 - (110...125)	24 - 60 - (110...125)
	V AC	230...240	230...240
	V DC	12 - 24 - 60 - 220	12 - 24 - 60 - 220
Rated power AC/DC	VA (50 Hz)/W	See page 9	See page 9
Operating range	AC/DC	0.8...1.1	0.8...1.1
	DC	(0.8...1.2)U <sub>N</sub>	(0.8...1.2)U <sub>N</sub>
Holding voltage	AC/DC	0.6 U <sub>N</sub> / 0.6 U <sub>N</sub>	0.6 U <sub>N</sub> / 0.6 U <sub>N</sub>
Must drop-out voltage	AC/DC	0.1 U <sub>N</sub> / 0.05 U <sub>N</sub>	0.1 U <sub>N</sub> / 0.05 U <sub>N</sub>

**Technical data**

Mechanical life AC/DC	cycles	10 · 10 <sup>6</sup>	10 · 10 <sup>6</sup>
Electrical life at rated load AC1	cycles	50 · 10 <sup>3</sup>	60 · 10 <sup>3</sup>
Operate/release time	ms	8/10	8/10
Insulation between coil and contacts (1.2/50 μs)	kV	6 (8 mm)	6 (8 mm)
Dielectric strength between open contacts	V AC	1000	1000
Ambient temperature range (U <sub>N</sub> ≤ 60 V / > 60 V)	°C	-40...+70 / -40...+55	-40...+70 / -40...+55
Protection category		IP 20	IP 20

**Approvals relay** (according to type)



### Single output - solid state relay interface modules, 14 mm wide.

#### Ideal interface for PLC and electronic systems

- DC input versions
- Supplied with integral coil indication and protection circuit
- Silent, high switching speed and long electrical life
- Instant ejection of relay using plastic retaining clip
- UL Listing (certain relay/socket combinations)
- 35 mm rail (EN 60715) mounting

38.31  
Screw terminal



38.41  
Screwless terminal



### 38.31/38.41

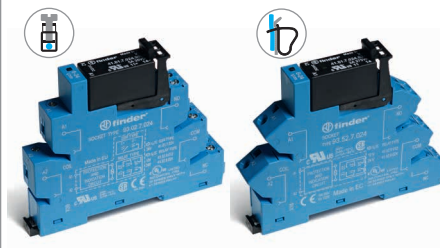

- Screw terminal and screwless terminal
- AC or DC output switching
- SSR relay - DC input voltage
- 35 mm rail (EN 60715) mounting

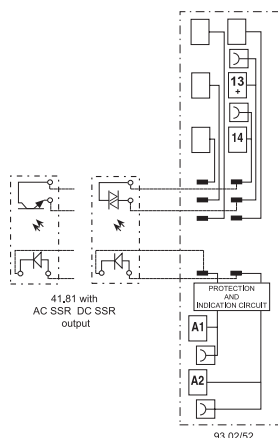

For outline drawing see page 13

#### Output specification

Contact configuration	1 NO (SPST-NO)	1 NO (SPST-NO)
Rated current/ Maximum peak current (10 ms)	A	5/40
Rated voltage/ Maximum blocking voltage	V	(24/35)DC
Switching voltage range	V	(1.5...24)DC
Repetitive peak off-state voltage	$V_{pk}$	600
Minimum switching current	mA	1
Max. "OFF-state" leakage current	mA	0.01
Max. "ON-state" voltage drop	V	0.3

#### Input specification

Nominal voltage ( $U_N$ )	V AC/DC	24
	V DC	12 - 24
Operating range	V DC	See page 10
Control current	mA	See page 10
Release voltage	V DC	See page 10

#### Technical data

Operate/release time: ON/OFF (DC input)	ms	0.05/0.25
Dielectric strength between input/output	V AC	2500
Ambient temperature range	°C	-20...+55
Environmental protection		IP 20

#### Approvals relay (according to type)



## Ordering information

### Electromechanical relay - 1 or 2 Pole

Example: 38 series screw terminal relay interface module, 1 CO (SPDT), sensitive 12 V DC coil.

B

3 8 . 5 1 . 7 . 0 1 2 . 0 0 5 0

A    B    C    D

**Series**

**Type**

- 0 = Electromechanical 16 A relay, with screw terminal
- 1 = Electromechanical 16 A relay, with screwless terminal
- 2 = Timer multifunction (AI, DI, GI, SW), with screw terminal
- 5 = Electromechanical relay, with screw terminal
- 6 = Electromechanical relay, with screwless terminal

**No. of poles**

- 1 = 1 pole, 6 or 16 A
- 2 = 2 pole, 8 A

**Coil version**

- 0 = AC (50/60 Hz)/DC, DC only, for 240 V version
- 3 = Leakage current suppression for (110...125)V AC/DC - (230...240)V AC
- 7 = Sensitive DC, (6, 12, 24, 48, 60)V only
- 8 = AC (50/60 Hz)

**Coil voltage**

See coil specifications

**D: Special versions**

0 = Standard

**C: Options**

- 5 = Standard DC
- 6 = Standard AC or AC/DC

**B: Contact circuit**

0 = CO (nPDT)

**A: Contact material**

- 0 = AgNi Standard
- 4 = AgSnO<sub>2</sub>
- 5 = AgNi + Au

Selecting features and options: only combinations in the same row are possible.

Type	Coil version	A	B	C	D
38.01/11	7	0 - 4	0	5	0
38.01/11	0 - 8	0 - 4	0	6	0
38.51/61	7	0 - 4 - 5	0	5	0
38.51/61	0 - 3 - 8	0 - 4 - 5	0	6	0
38.52/62	7	0 - 5	0	5	0
38.52/62	0 - 8	0 - 5	0	6	0
38.21	0	0	0	6	0

## Ordering information

### Solid state relay - Single output - 6.2 & 14 mm wide

Example: 38 series screw terminal SSR relay interface module, 6.2 mm wide, 6 A output, 24 V DC input.

**3 8 . 8 1 . 7 . 0 2 4 . 9 0 2 4**

**Series**

**Type**

- 21 = Timer SSR 6.2 mm wide, with screw terminal
- 31 = SSR 14 mm wide, with screw terminal
- 41 = SSR 14 mm wide, with screwless terminal
- 81 = SSR 6.2 mm wide, with screw terminal
- 91 = SSR 6.2 mm wide, with screwless terminal

**Input version**

- 0 = AC (50/60 Hz)/DC, DC only, for 240 V version
- 3 = Leakage current suppression for (110...125)V AC/DC and (230...240)V AC SSR only
- 7 = DC, (6, 24, 60)V SSR only

**Input voltage**

See input specifications

**Output version**

- 9024 = 6 A - 24 V DC (38.21, 38.81 & 38.91)
- 9024 = 5 A - 24 V DC (38.31 & 38.41)
- 7048 = 0.1 A - 48 V DC (38.81 & 38.91)
- 8240 = 2 A - 240 V AC (38.21, 38.81 & 38.91)
- 8240 = 3 A - 240 V AC (38.31 & 38.41)

B

Selecting features and options: only combinations in the same row are possible.

Type	Input version	Output version
38.81/91	7	9024 - 7048 - 8240
38.81/91	0 - 3	9024 - 7048 - 8240
38.31/41	0 - 7	9024 - 8240
38.21	0	9024 - 8240



### Technical data - 1 & 2 Pole Electromechanical Relays

#### Insulation

Insulation according to EN 61810-1	insulation rated voltage	V	250	400
	rated impulse withstand voltage	kV	4	4
	pollution degree		3	2
	overvoltage category		III	III
Insulation between coil and contacts (1.2/50 μs)		kV	6 (8 mm)	
Dielectric strength between open contacts		V AC	1000	

#### Insulation between coil terminals

Rated impulse voltage (surge) differential mode (according to EN 61000-4-5)	kV (1.2/50 μs)	2
---	----------------	---

#### Other data

		1 Pole 6 A	1 Pole 16 A - 2 Pole 8 A
Bounce time: NO/NC	ms	1/6	2/5
Vibration resistance (10...55)Hz: NO/NC	g	10/5	15/2
Power lost to the environment	without contact current	W	0.2 (12 V) - 0.9 (240 V)
	with rated current	W	0.5 (12 V) - 1.5 (240 V)
			1.3 (24 V) - 1.7 (240 V)

#### Terminals

Wire strip length	mm	10	10		
⊖ Screw torque	Nm	0.5	—		
Max. wire size		solid cable	stranded cable	solid cable	stranded cable
	mm <sup>2</sup>	1 x 2.5 / 2 x 1.5	1 x 2.5 / 2 x 1.5	1 x 2.5	1 x 2.5
	AWG	1 x 14 / 2 x 16	1 x 14 / 2 x 16	1 x 14	1 x 14
		<b>38.01 / 38.52</b>		<b>38.11 / 38.62</b>	
Wire strip length	mm	10	10		
⊖ Screw torque	Nm	0.5	—		
Max. wire size		solid cable	stranded cable	solid cable	stranded cable
	mm <sup>2</sup>	1 x 2.5 / 2 x 1.5	1 x 2.5 / 2 x 1.5	1 x 2.5	1 x 2.5
	AWG	1 x 14 / 2 x 16	1 x 14 / 2 x 16	1 x 14	1 x 14

### Contact specification - 1 & 2 Pole Electromagnetic Relays

F 38 - Electrical life (AC) v contact current, 1 Pole 6 A

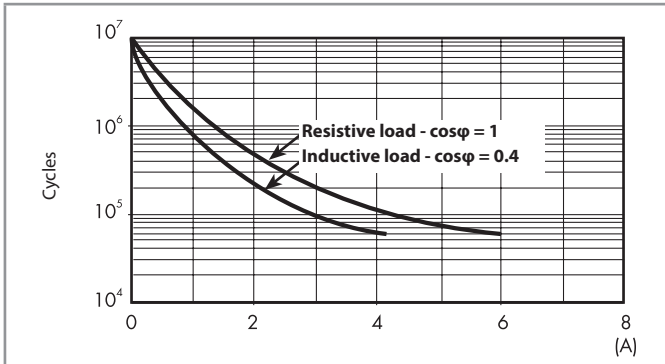

H 38 - Maximum DC1 breaking capacity, 1 Pole 6 A

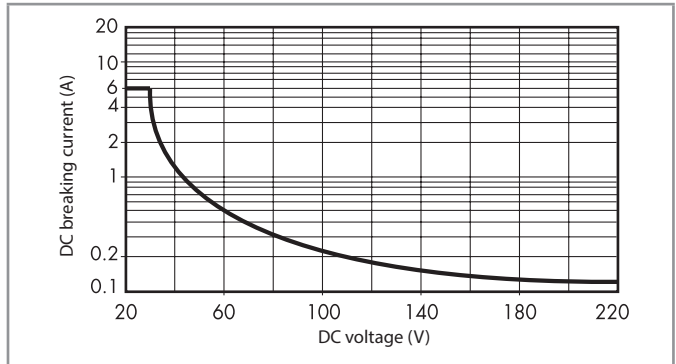

F 38 - Electrical life (AC) v contact current, 1 Pole 16 A and 2 Pole 8 A

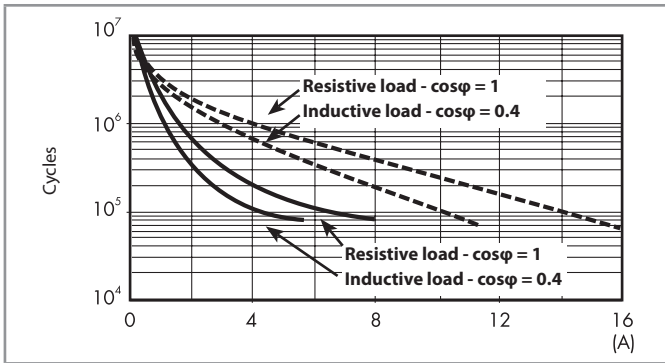

H 38 - Maximum DC1 breaking capacity, 1 Pole 16 A and 2 Pole 8 A

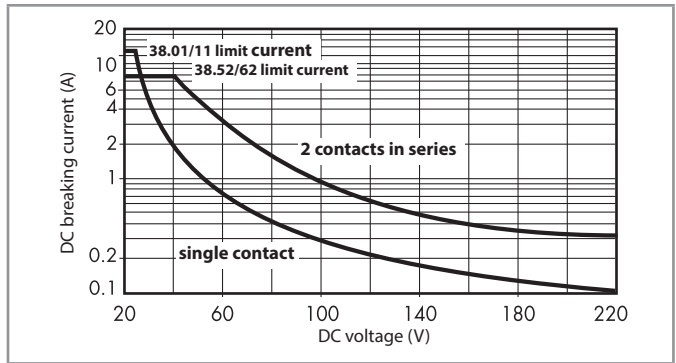

— : 2 Pole 8 A  
— : 1 Pole 16 A

- When switching a resistive load (DC1) having voltage and current values under the curve, an electrical life of  $\geq 60 \cdot 10^3$  (1 Pole) or  $\geq 80 \cdot 10^3$  (2 Pole) can be expected.
- In the case of DC13 loads, the connection of a diode in parallel with the load will permit a similar electrical life as for a DC1 load. Note: the release time for the load will be increased.



### Coil specifications - 1 Pole 6 A Electromechanical Relay

**Coil data sensitive DC, 1 Pole**

Nominal voltage $U_N$	Coil code	Operating range		Rated coil consumption I at $U_N$	Power consumption P at $U_N$
		$U_{min}$	$U_{max}$		
V		V	V	mA	W
6	7.006	4.8	7.2	35	0.2
12	7.012	9.6	14.4	15.2	0.2
24	7.024	19.2	28.8	10.4	0.3
48	7.048	38.4	57.6	6.3	0.3
60	7.060	48	72	7	0.4
220	0.240	176	264	4	0.9

**Coil data AC/DC, 1 Pole**

Nominal voltage $U_N$	Coil code	Operating range		Rated coil consumption I at $U_N$	Power consumption P at $U_N$
		$U_{min}$	$U_{max}$		
V		V	V	mA	VA/W
12	0.012	9.6	13.2	16	0.2/0.2
24	0.024	19.2	26.4	12	0.3/0.2
48	0.048	38.4	52.8	6.9	0.3/0.3
60	0.060	48	66	7	0.5/0.5
110...125	0.125	88	138	5(*)	0.6/0.6(*)

(\*) Rated coil consumption and power consumption values relate to  $U_N = 125$  V.

**Coil data AC, 1 Pole (indicated for max ambient temperature +70 °C)**

Nominal voltage $U_N$	Coil code	Operating range		Rated coil consumption I at $U_N$	Power consumption P at $U_N$
		$U_{min}$	$U_{max}$		
V		V	V	mA	VA/W
(230...240) AC	8.240	184	264	3	0.7/0.3

**Coil data, leakage current suppression types, 1 Pole**

Nominal voltage $U_N$	Coil code	Operating range		Rated coil consumption I at $U_N$	Power consumption P at $U_N$
		$U_{min}$	$U_{max}$		
V		V	V	mA	VA/W
(110...125) AC/DC	3.125	94	138	8(*)	1/1(*)
(230...240) AC	3.240	184	264	7(*)	1.7/0.5(*)

(\*) Rated coil consumption and power consumption values relate to  $U_N = 125$  and 240 V.

The 38 Series interface modules (supply version 3) have built-in leakage current suppression to address industry concerns of the contacts not dropping-out when there is residual current in the circuit; at (110...125)V AC and (230...240)V AC.

This problem can occur, for example, when connecting the interface modules to PLCs with triac outputs or when connecting via relatively long cables.

### Coil specifications - 1 Pole 16 A and 2 Pole 8 A Electromechanical Relay

**Coil data sensitive DC, 1 Pole 16 A and 2 Pole 8 A**

Nominal voltage $U_N$	Coil code	Operating range		Rated coil consumption I at $U_N$	Power consumption P at $U_N$
		$U_{min}$	$U_{max}$		
V		V	V	mA	W
12	7.012	9.6	14.4	41	0.5
24	7.024	19.2	28.8	19.5	0.5
60	7.060	48	72	8	0.5
220	0.240	176	264	4	0.9

**Coil data AC/DC, 1 Pole 16 A and 2 Pole 8 A**

Nominal voltage $U_N$	Coil code	Operating range		Rated coil consumption I at $U_N$	Power consumption P at $U_N$
		$U_{min}$	$U_{max}$		
V		V	V	mA	W
24	0.024	19.2	26.4	20	0.5/0.5
60	0.060	48	66	7.1	0.5/0.5
110...125	0.125	88	138	4.6	0.6/0.6

**Coil data AC, 1 Pole 16 A and 2 Pole 8 A**

Nominal voltage $U_N$	Coil code	Operating range		Rated coil consumption I at $U_N$	Power consumption P at $U_N$
		$U_{min}$	$U_{max}$		
V		V	V	mA	VA/W
230...240	8.230	184	264	5.3	1.2/0.6

### Coil specification - 1 & 2 Pole Electromagnetic Relays

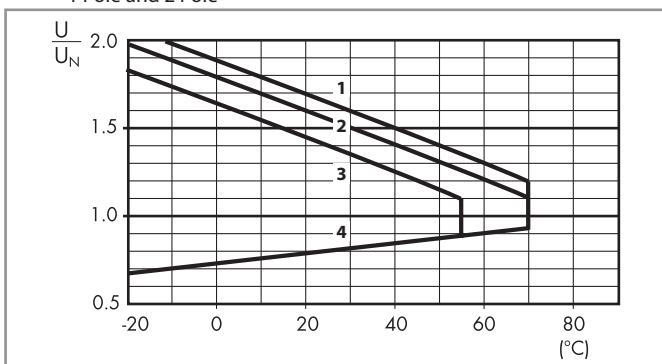

**R 38 - DC coil operating range v ambient temperature**

1 Pole and 2 Pole



- 1 - Max. permitted coil voltage at nominal load (DC coil).
- 2 - Max. permitted coil voltage at nominal load (AC/DC coils  $U \leq 60$  V).
- 3 - Max. permitted coil voltage at nominal load (AC/DC coils  $U > 60$  V).
- 4 - Min pick-up voltage with coil at ambient temperature.

## Technical data - Solid State Relays

Other data		38.81/38.91		38.31/38.41	
Power lost to the environment	without output current	W	0.25 (24 V DC)	0.5	
	with rated current	W	0.4	2.2 (DC output)/3 (AC output)	
Terminals		38.81		38.91	
Wire strip length	mm	10		10	
 Screw torque	Nm	0.5		—	
Max. wire size		solid cable	stranded cable	solid cable	stranded cable
	mm <sup>2</sup>	1 x 2.5 / 2 x 1.5	1 x 2.5 / 2 x 1.5	1 x 2.5	1 x 2.5
	AWG	1 x 14 / 2 x 16	1 x 14 / 2 x 16	1 x 14	1 x 14
		<b>38.31</b>		<b>38.41</b>	
Wire strip length	mm	10		10	
 Screw torque	Nm	0.5		—	
Max. wire size		solid cable	stranded cable	solid cable	stranded cable
	mm <sup>2</sup>	1 x 2.5 / 2 x 1.5	1 x 2.5 / 2 x 1.5	1 x 2.5	1 x 2.5
	AWG	1 x 14 / 2 x 16	1 x 14 / 2 x 16	1 x 14	1 x 14

## Input specifications - Solid State Relays type 38.81 and 38.91 - 6.2 mm wide

### Input data DC

Nominal voltage	Supply code	Operating range		Release voltage	Rated coil consumption	Power consumption
		U <sub>min</sub>	U <sub>max</sub>			
U <sub>N</sub>		V	V	U	I at U <sub>N</sub>	P
V		V	V	V	mA	W
6	7.006	5	7.2	2.4	7	0.2
24	7.024	16.8	30	10	10.5	0.3
60	7.060	35.6	72	20	6.5	0.4
220	0.240	176	264	—	4	0.9

### Input data AC/DC

Nominal voltage	Supply code	Operating range		Release voltage	Rated coil consumption	Power consumption
		U <sub>min</sub>	U <sub>max</sub>			
U <sub>N</sub>		V	V	U	I at U <sub>N</sub>	P
V		V	V	V	mA	VA/W
110...125	0.125	88	138	22	5.5*	0.7/0.7

(\*) Rated coil consumption and power consumption values relate to U<sub>N</sub> = 125 and 240 V.

### Input data - Leakage current suppression types

Nominal voltage	Supply code	Operating range		Release voltage	Rated coil consumption	Power consumption
		U <sub>min</sub>	U <sub>max</sub>			
U <sub>N</sub>		V	V	U	I at U <sub>N</sub>	P at U <sub>N</sub>
V		V	V	V	mA	W
110...125 AC/DC	3.125	94	138	44	8(*)	1/1(*)
230...240 AC	3.240	184	264	72	6.5(*)	1.6/0.6(*)

(\*) Rated coil consumption and power consumption values relate to U<sub>N</sub> = 125 and 240 V.

The 38 Series interface modules (supply version 3) have built-in leakage current suppression to address industry concerns of the contacts not dropping-out when there is residual current in the circuit; at (110...125)V AC and (230...240)V AC.

This problem can occur, for example, when connecting the interface modules to PLCs with triac outputs or when connecting via relatively long cables.

## Input specification - Solid State Relay types 38.31 and 38.41 - 14 mm wide

### Input data DC

Nominal voltage	Supply code	Operating range		Release voltage	Rated coil consumption	Power consumption
		U <sub>min</sub>	U <sub>max</sub>			
U <sub>N</sub>		V	V	U	I at U <sub>N</sub>	P
V		V	V	V	mA	W
12	7.012	9.6	18	5	9	0.2
24	7.024	16.8	30	5	12	0.3

### Input data AC/DC

Nominal voltage	Supply code	Operating range		Release voltage	Rated coil consumption	Power consumption
		U <sub>min</sub>	U <sub>max</sub>			
U <sub>N</sub>		V	V	U	I at U <sub>N</sub>	P
V		V	V	V	mA	W
24	0.024	16.8	30	9	16.5	0.3

## Output specification - Solid State Relays

### L 34-1 - Output DC current v ambient temperature

38.x1.x.xxx.9024 (only 38.81/91/21)

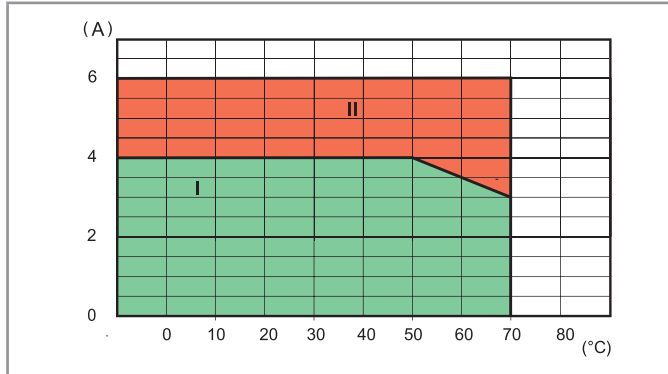

### L 34 - Output AC current v ambient temperature

38.x1.x.xxx.8240 (only 38.81/91/21)

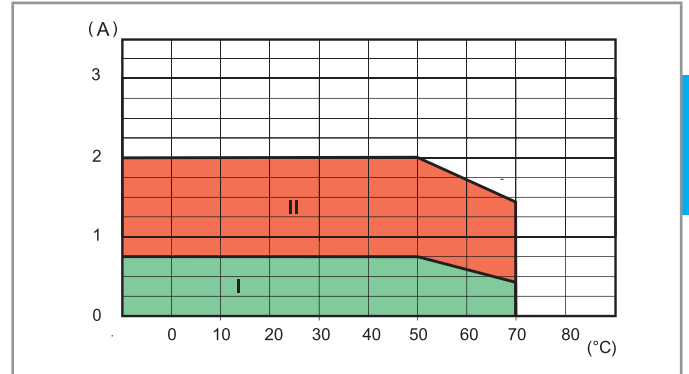

I: SSR installed as a group (without gap between sockets)

II: SSR installed individually in free air, or with a gap  $\geq 9$  mm, which implies a not significant influence from nearby components

**Max recommended switching frequency** (Cycles/Hour, with 50% Duty-cycle) at ambient temperature 50°C, single mounting (only 38.81/91/21)

Load	38.x1.x.xxx.9024	38.x1.x.xxx.8240	38.x1.x.xxx.7048
24 V 6 A DC I	180 000	—	—
24 V 3 A DC L/R = 10 ms	5000	—	—
24 V 2 A DC L/R = 40 ms	3600	—	—
24 V 1 A DC L/R = 40 ms	6500	—	—
24 V 0.8 A DC L/R = 40 ms	9000	—	—
24 V 1.5 A DC L/R = 80 ms	3250	—	—
230 V 2 A AC I	—	60 000	—
230 V 1.25 A AC15	—	3600	—
48 V 0.1 A DC I	—	—	60 000

**Additional technical data - Timed Interface Module**

EMC specifications			
Type of test		Reference standard	
Electrostatic discharge	contact discharge	EN 61000-4-2	4 kV
	air discharge	EN 61000-4-2	8 kV
Radio-frequency electromagnetic field (80 ÷ 1000 MHz)		EN 61000-4-3	10 V/m
Fast transients (burst) (5-50 ns, 5 kHz) on Supply terminals		EN 61000-4-4	4 kV
Surges (1.2/50 µs) on Supply terminals	common mode	EN 61000-4-5	4 kV
	differential mode	EN 61000-4-5	4 kV
Radio-frequency common mode (0.15 ÷ 80 MHz) on Supply terminals		EN 61000-4-6	10 V
Radiated and conducted emission		EN 55022	class B
Other data		EMR	SSR
Power lost to the environment	without contact current	W	0.1
	with rated current	W	0.6
Terminals		38.21	
Wire strip length		mm	10
Screw torque		Nm	0.5
Max. wire size	solid cable		stranded cable
	mm <sup>2</sup>	1 x 2.5 / 2 x 1.5	1 x 2.5 / 2 x 1.5
	AWG	1 x 14 / 2 x 16	1 x 14 / 2 x 16

**Times scales**

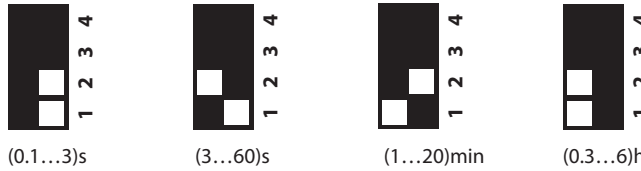

**Functions**

LED	Supply voltage	NO contact/output
	OFF	Open
	ON	Open (time in progress)
	ON	Closed

**Wiring diagram**

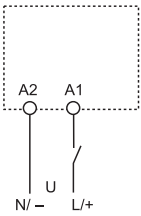

U = Supply voltage

= Output contact

**(AI) On-delay.**  
Apply power to timer. Output contacts transfer after preset time has elapsed. Reset occurs when power is removed.

**(DI) Interval.**  
Apply power to timer. Output contacts transfer immediately. After the preset time has elapsed, contacts reset.

**(GI) Pulse delayed.**  
Apply power to timer. Output contacts transfer after preset time has elapsed. Reset occurs after a fixed time of 0.5 s.

**(SW) Symmetrical flasher (starting pulse on).**  
Apply power to timer. Output contacts transfer immediately and cycle between ON and OFF for as long as power is applied. The ratio is 1:1 (time on = time off).

Outline drawings

Types 38.21  
38.51 / 38.51.3  
38.81 / 38.81.3  
Screw terminal

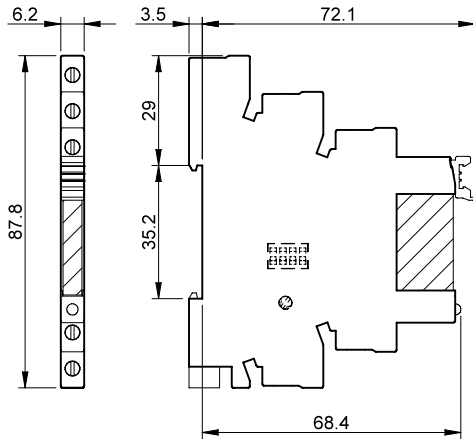

Types 38.01  
38.31  
38.52  
Screw terminal

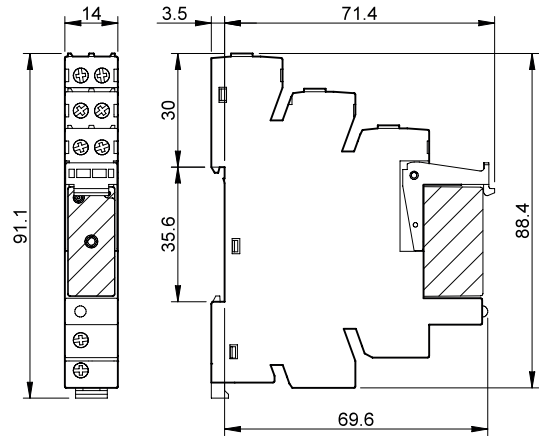

Types 38.61 / 38.61.3  
38.91 / 38.91.3  
Screwless terminal

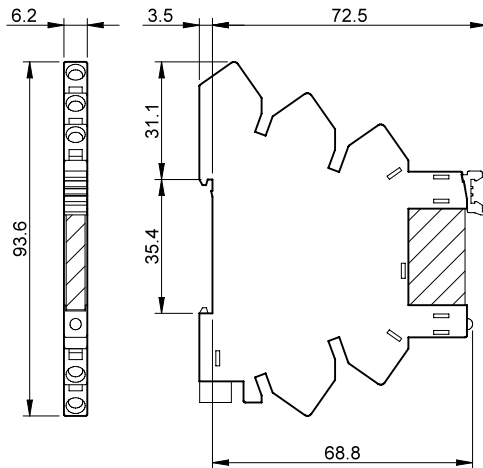

Types 38.11  
38.41  
38.62  
Screwless terminal

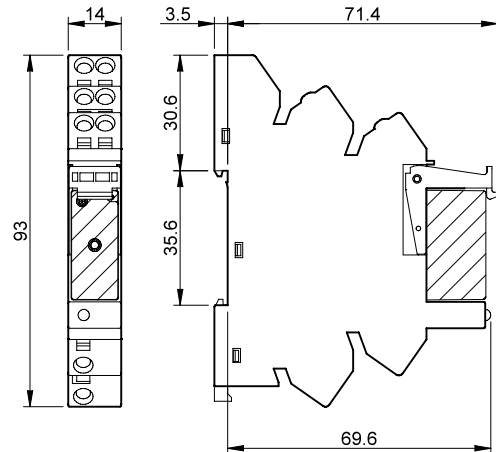

B

## Electromechanical Relay & Socket Combinations

### Screw terminal - 1 Pole relay 6 A

Interface Module Code	Coil voltage	Relay	Socket
38.51.0.012.0060	12 V AC/DC	34.51.7.012.0010	93.01.0.024
38.51.0.024.0060	24 V AC/DC	34.51.7.024.0010	93.01.0.024
38.51.0.048.0060	48 V AC/DC	34.51.7.048.0010	93.01.0.060
38.51.0.060.0060	60 V AC/DC	34.51.7.060.0010	93.01.0.060
38.51.0.125.0060	(110...125)V AC/DC	34.51.7.060.0010	93.01.0.125
38.51.3.125.0060	(110...125)V AC/DC	34.51.7.060.0010	93.01.3.125
38.51.3.240.0060	(230...240)V AC	34.51.7.060.0010	93.01.3.240
38.51.7.006.0050	6 V DC	34.51.7.005.0010	93.01.7.024
38.51.7.012.0050	12 V DC	34.51.7.012.0010	93.01.7.024
38.51.7.024.0050	24 V DC	34.51.7.024.0010	93.01.7.024
38.51.7.048.0050	48 V DC	34.51.7.048.0010	93.01.7.060
38.51.7.060.0050	60 V DC	34.51.7.060.0010	93.01.7.060
38.51.0.240.0060	220 V DC	34.51.7.060.0010	93.01.0.240
38.51.8.240.0060	(230...240)V AC	34.51.7.060.0010	93.01.8.240

### Screwless terminal - 1 Pole relay 6 A

Interface Module Code	Coil voltage	Relay	Socket
38.61.0.012.0060	12 V AC/DC	34.51.7.012.0010	93.51.0.024
38.61.0.024.0060	24 V AC/DC	34.51.7.024.0010	93.51.0.024
38.61.0.125.0060	(110...125)V AC/DC	34.51.7.060.0010	93.51.0.125
38.61.3.125.0060	(110...125)V AC/DC	34.51.7.060.0010	93.51.3.125
38.61.3.240.0060	(230...240)V AC	34.51.7.060.0010	93.51.3.240
38.61.7.012.0050	12 V DC	34.51.7.012.0010	93.51.7.024
38.61.7.024.0050	24 V DC	34.51.7.024.0010	93.51.7.024
38.61.0.240.0060	220 V DC	34.51.7.060.0010	93.51.0.240
38.61.8.240.0060	(230...240)V AC	34.51.7.060.0010	93.51.8.240

### Screw terminal - 1 Pole relay 16 A

Interface Module Code	Coil voltage	Relay	Socket
38.01.7.012.0050	12 V DC	41.61.9.012.0010	93.02.7.024
38.01.7.024.0050	24 V DC	41.61.9.024.0010	93.02.7.024
38.01.7.060.0050	60 V DC	41.61.9.060.0010	93.02.7.060
38.01.0.024.0060	24 V AC/DC	41.61.9.024.0010	93.02.0.024
38.01.0.060.0060	60 V AC/DC	41.61.9.060.0010	93.02.0.060
38.01.0.125.0060	125 V AC/DC	41.61.9.110.0010	93.02.0.125
38.01.0.240.0060	220 V DC	41.61.9.110.0010	93.02.0.240
38.01.8.230.0060	230 V AC	41.61.9.110.0010	93.02.8.230

### Screwless terminal - 1 Pole relay 16 A

Interface Module Code	Coil voltage	Relay	Socket
38.11.7.012.0050	12 V DC	41.61.9.012.0010	93.52.7.024
38.11.7.024.0050	24 V DC	41.61.9.024.0010	93.52.7.024
38.11.7.060.0050	60 V DC	41.61.9.060.0010	93.52.7.060
38.11.0.024.0060	24 V AC/DC	41.61.9.024.0010	93.52.0.024
38.11.0.060.0060	60 V AC/DC	41.61.9.060.0010	93.52.0.060
38.11.0.125.0060	125 V AC/DC	41.61.9.110.0010	93.52.0.125
38.11.0.240.0060	220 V DC	41.61.9.110.0010	93.52.0.240
38.11.8.230.0060	230 V AC	41.61.9.110.0010	93.52.8.230

### Screw terminal - 2 Pole relay 8 A

Interface Module Code	Coil voltage	Relay	Socket
38.52.0.024.0060	24 V AC/DC	41.52.9.024.0010	93.02.0.024
38.52.0.060.0060	60 V AC/DC	41.52.9.060.0010	93.02.0.060
38.52.0.125.0060	(110...125)V AC/DC	41.52.9.110.0010	93.02.0.125
38.52.7.012.0050	12 V DC	41.52.9.012.0010	93.02.7.024
38.52.7.024.0050	24 V DC	41.52.9.024.0010	93.02.7.024
38.52.7.060.0050	60 V DC	41.52.9.060.0010	93.02.7.060
38.52.0.240.0060	220 V DC	41.52.9.110.0010	93.02.0.240
38.52.8.230.0060	(230...240)V AC	41.52.9.110.0010	93.02.8.230

### Screwless terminal - 2 Pole relay 8 A

Interface Module Code	Coil voltage	Relay	Socket
38.62.0.024.0060	24 V AC/DC	41.52.9.024.0010	93.52.0.024
38.62.0.060.0060	60 V AC/DC	41.52.9.060.0010	93.52.0.060
38.62.0.125.0060	(110...125)V AC/DC	41.52.9.110.0010	93.52.0.125
38.62.7.012.0050	12 V DC	41.52.9.012.0010	93.52.7.024
38.62.7.024.0050	24 V DC	41.52.9.024.0010	93.52.7.024
38.62.7.060.0050	60 V DC	41.52.9.060.0010	93.52.7.060
38.62.0.240.0060	220 V DC	41.52.9.110.0010	93.52.0.240
38.62.8.230.0060	(230...240)V AC	41.52.9.110.0010	93.52.8.230

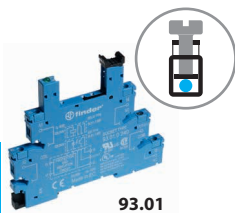

93.01

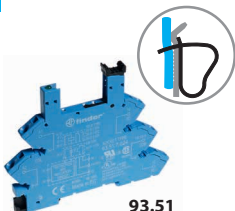

93.51

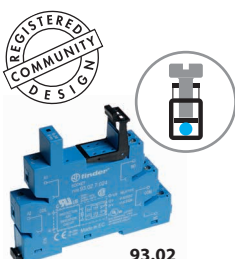

93.02



93.52

Approvals

(according to type):

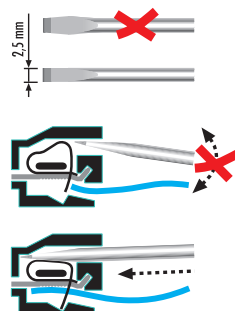
 Certain relay/socket combinations

### Solid State Relay & Socket Combinations - 6.2 mm wide

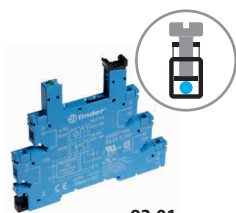

93.01

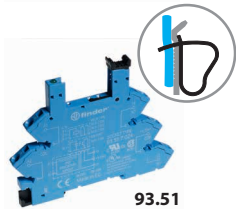

93.51

Approvals  
(according to type):



Certain relay/socket combinations

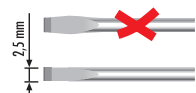

#### Screw terminal

Interface Module Code	Input voltage	Relay	Socket
38.81.7.006.xxxx	6 V DC	34.81.7.005.xxxx	93.01.7.024
38.81.7.024.xxxx	24 V DC	34.81.7.024.xxxx	93.01.7.024
38.81.7.060.xxxx	60 V DC	34.81.7.060.xxxx	93.01.7.060
38.81.0.125.xxxx	(110...125)V AC/DC	34.81.7.060.xxxx	93.01.0.125
38.81.0.240.xxxx	220 V DC	34.81.7.060.xxxx	93.01.0.240
38.81.3.125.xxxx	(110...125)V AC/DC	34.81.7.060.xxxx	93.01.3.125
38.81.3.240.xxxx	(230...240)V AC	34.81.7.060.xxxx	93.01.3.240

#### Screwless terminal

Interface Module Code	Input voltage	Relay	Socket
38.91.7.006.xxxx	6 V DC	34.81.7.005.xxxx	93.51.7.024
38.91.7.024.xxxx	24 V DC	34.81.7.024.xxxx	93.51.7.024
38.91.7.060.xxxx	60 V DC	34.81.7.060.xxxx	93.51.7.060
38.91.0.125.xxxx	(110...125)V AC/DC	34.81.7.060.xxxx	93.51.0.125
38.91.0.240.xxxx	220 V DC	34.81.7.060.xxxx	93.51.0.240
38.91.3.125.xxxx	(110...125)V AC/DC	34.81.7.060.xxxx	93.51.3.125
38.91.3.240.xxxx	(230...240)V AC	34.81.7.060.xxxx	93.51.3.240

Example: .xxxx  
.9024  
.7048  
.8240

### Solid State Relay & Socket Combinations - 14 mm wide

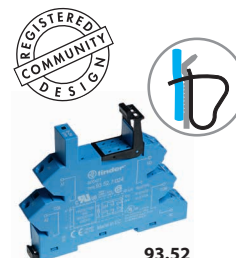

93.52

Approvals  
(according to type):



#### Screw terminal

Interface Module Code	Input voltage	Relay	Socket
38.31.0.024.xxxx	24 V AC/DC	41.81.7.024.xxxx	93.02.0.024
38.31.7.012.xxxx	12 V DC	41.81.7.012.xxxx	93.02.7.024
38.31.7.024.xxxx	24 V DC	41.81.7.024.xxxx	93.02.7.024

#### Screwless terminal

Interface Module Code	Input voltage	Relay	Socket
38.41.0.024.xxxx	24 V AC/DC	41.81.7.024.xxxx	93.52.0.024
38.41.7.012.xxxx	12 V DC	41.81.7.012.xxxx	93.52.7.024
38.41.7.024.xxxx	24 V DC	41.81.7.024.xxxx	93.52.7.024

### SSR / EMR & Timer Socket Combinations

#### Screw terminal

Interface Module Code	Input / Coil voltage	Relay	Socket
38.21.0.012.0060	12 V AC/DC	34.51.7.012.0010	93.21.0.024
38.21.0.024.0060	24 V AC/DC	34.51.7.024.0010	93.21.0.024
38.21.0.024.xxxx	24 V AC/DC	34.81.7.024.xxxx	93.21.0.024

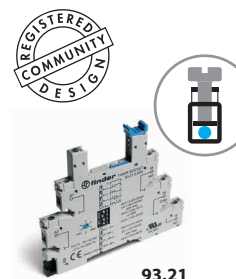

93.21

Approvals  
(according to type):



Accessories

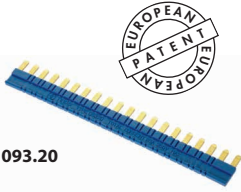

093.20

B

Approvals  
(according to type):



<b>20-way jumper link</b> for 38.21/51/61/81/91	093.20 (blue)	093.20.0 (black)	093.20.1 (red)
Rated values	36 A* - 250 V		

\* Maximum capacity of the jumper link. Each individual pole must not exceed the 6 A limit of the interface to which it is connected.

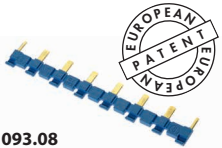
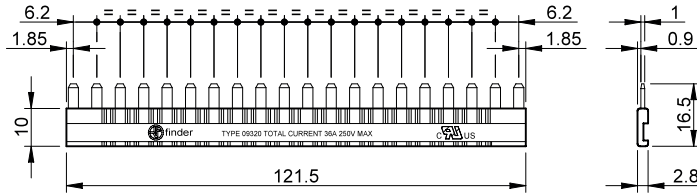

093.08

Approvals  
(according to type):



<b>8-way jumper link</b> for 38.01/11/31/41/52/62	093.08 (blue)	093.08.0 (black)	093.08.1 (red)
Rated values	10 A - 250 V		

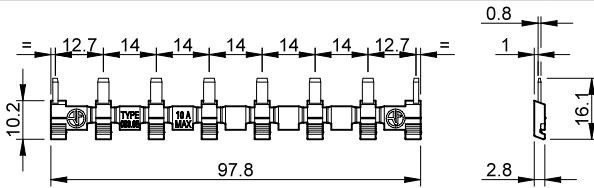

093.01

<b>Plastic separator</b>	093.01
--------------------------	--------

Thickness 2 mm, required at the start and the end of a group of interfaces.

Can be used for visual separation group, must be used for:

- protective separation of different voltages of neighbouring PLC interfaces according to VDE 0106-101
- protection of cut jumper links

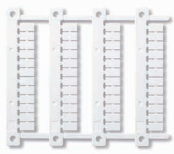

093.48

<b>Sheet of marker tags</b> for 38.21/51/61/81/91, plastic, 48 tags, 6 x 10 mm	093.48
--	--------

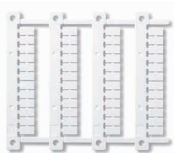

060.48

<b>Sheet of marker tags (CEMBRE Thermal transfer printers)</b> for 38.01/11/31/41/52/62 types (48 tags), 6 x 12 mm	060.48
--	--------



# MasterINTERFACE - Relay interface modules 0.1 - 2 - 6 A



Packaging machines



Bottling plant



Traffic light controls



Carousel warehouses



Control panels



Panels for electrical distribution



Labelling machines



Hoists and cranes

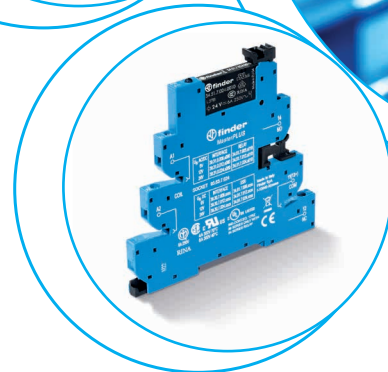
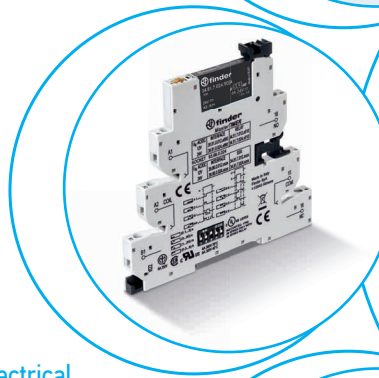



**Common features**

- Space saving 6.2 mm wide
- Connections for 16-way jumper link
- Integral coil indication and protection circuit
- Secure retention and easy ejection by plastic clip
- Dual screw head (blade+cross) terminals and Push-in terminals versions
- 35 mm rail mounting (EN 60715)

**MasterBASIC**

- For general use in any type of system
- **EMR: 6 to 24 and 125 V AC/DC, 230 V AC supply**
- **SSR: 6 to 24 V DC, 125 V AC/DC, 230 V AC supply**
- Screw terminal and Push-in terminal

**MasterBASIC - EMR ATEX**

- Available on request - See page 16

**MasterPLUS**

- Accepts the output fuse module, for the easy and space efficient protection of output circuits
- **EMR: 6 to 125 V AC/DC, 125 and 220 V DC, 230 V AC and 24...240 V AC/DC supply**
- **SSR: 24 - 125 V AC/DC, 6 to 220 V DC, 230 V AC and 24...240 V AC/DC supply**
- **Special 125 V AC/DC and 230 V AC leakage current suppression types (39.31.3, 39.61.3 EMR and 39.30.3, 39.60.3 SSR)**
- Screw terminal and Push-in terminal

**MasterINPUT**

- Jumper link option for the quick and easy distribution of supply voltage to proximity switches and similar input devices
- **EMR: 6 to 24 V and 125 V AC/DC, 230 V AC supply**
- **SSR: 6 - 24 V DC, 24 - 125 V AC/DC, 230 V AC supply**
- Screw terminal and Push-in terminal

**MasterOUTPUT**

- Jumper link option for the quick and easy distribution of supply voltage to output side and its connection to electromagnetic valves and similar output devices
- **EMR: 6 to 24 V and 125 V AC/DC, 230 V AC supply**
- **SSR: 6 to 24 V DC, 125 V AC/DC, 230 V AC supply**
- Screw terminal and Push-in terminal

**MasterTIMER**

- Timer adjustment via top mounted rotary knob accessible after assembly
- Control signal terminal
- DIP-switch for selection of 4 time scales and 8 functions
- Output with fuse module option
- **EMR and SSR: 12 to 24 V AC/DC supply**
- Screw terminal and Push-in terminal

**EMR  
Electromechanical Relays**

- **1 CO 6 A/250 V AC**
- High switching capability

**SSR  
Solid State Relays**

- 1 solid state output (options **0.1 A/48 V DC, 6 A/24 V DC, 2 A/240 V AC**)
- Silent, high speed switching, long electrical life

39.11/39.01



Page 6

39.10/39.00



Page 7

39.31 - 39.31.3/39.61 - 39.61.3



Page 8

39.30 - 39.30.3/39.60 - 39.60.3

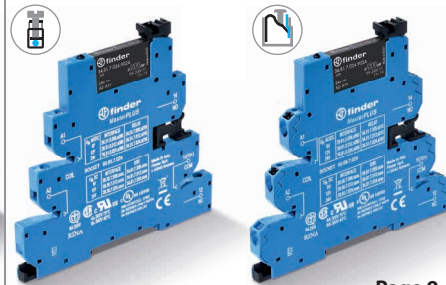

Page 9

39.41/39.71



Page 10

39.40/39.70



Page 11

39.21/39.51



Page 12

39.20/39.50



Page 13

39.81/39.91

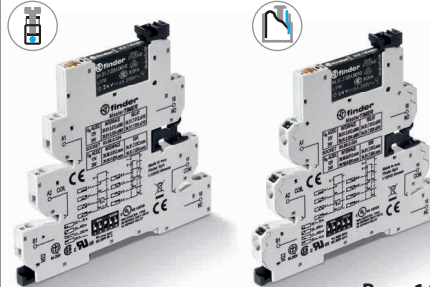

Page 14

39.80/39.90



Page 15

**MasterBASIC**

**39.11 - 39.10 - 39.01 - 39.00**

- For general interface use in any type of system and application.
- Can be used for input interface applications between auxiliary contacts, sensors etc. and controllers, PLC's or motors. Or for output interface between PLC's controllers and relays, solenoids etc.

**MasterPLUS**

**39.31 - 39.30 - 39.31.3 - 39.30.3 - 39.61 - 39.60 - 39.61.3 - 39.60.3**

- This special version provides extra protection for the output circuit thanks to the replaceable fuse module.
- For general interface use in any type of system and application.
- Can be used for input interface applications between auxiliary contacts, sensors etc. and controllers, PLC's or motors. Or for output interface between PLC's controllers and relays, solenoids etc.

B

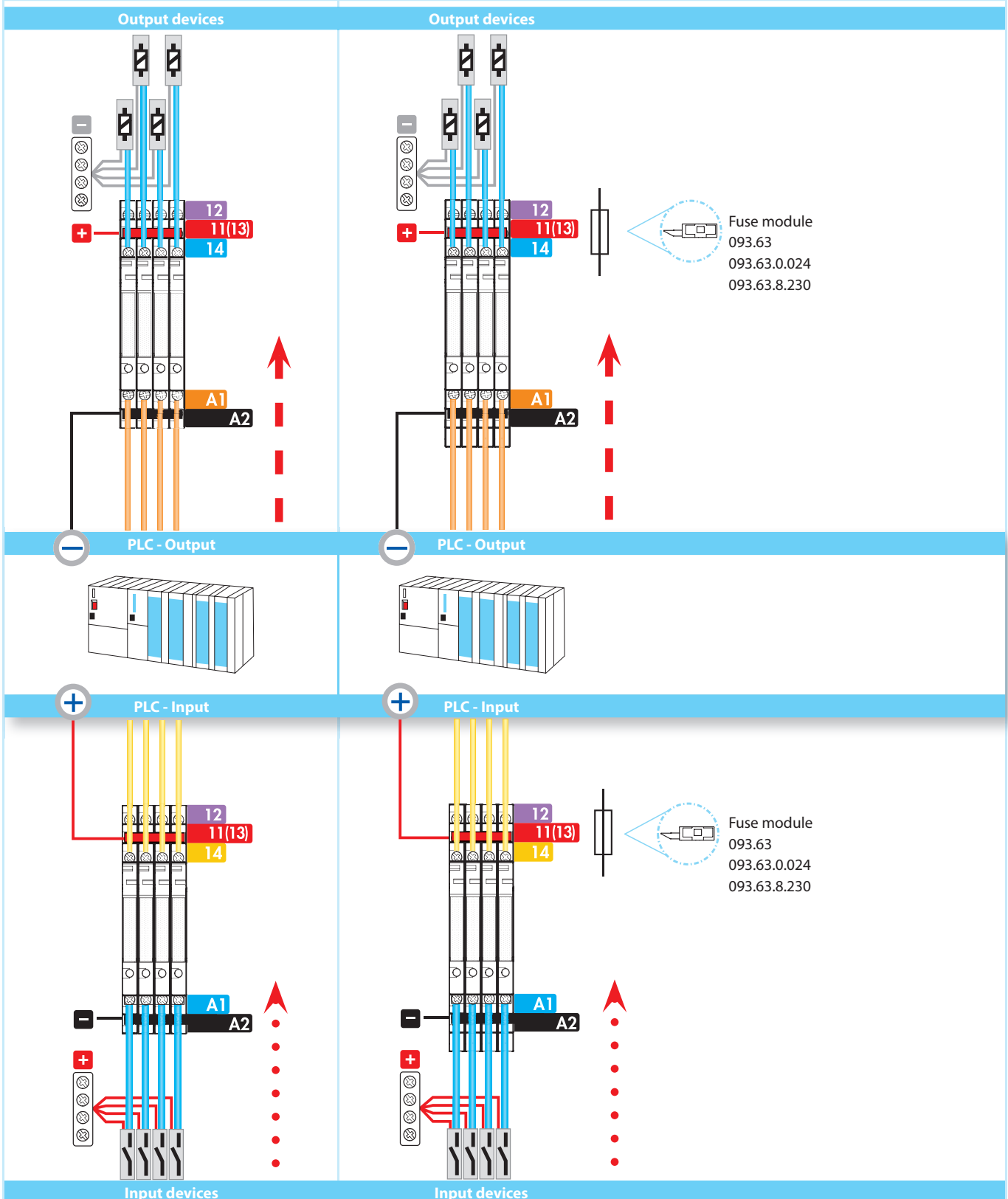

**MasterINPUT**

**39.41 - 39.40 - 39.71 - 39.70**

- These models allow the full termination of input device to the interface without the need for additional terminals - saving component cost, time and panel space.
- Quick and easy distribution of supply voltage through the jumper link on the Bus-Bar (BB) connection.
- Ideal for interface applications between the auxiliary contacts, sensors, limit switches and Controllers or PLC's.

**MasterOUTPUT**

**39.21 - 39.20 - 39.51 - 39.50**

- These models allow the full termination of output device to the interface without the need for additional terminals - saving component cost, time and panel space.
- Quick and easy distribution of supply voltage through the jumper link on the Bus-Bar (BB) connection.
- Ideal for interface applications between the PLC's or Controllers and output devices such as electromagnetic valves or motors etc..

**MasterTIMER**

**39.81 - 39.80 - 39.91 - 39.90**

- Slim and Multifunction Timed Interface modules.

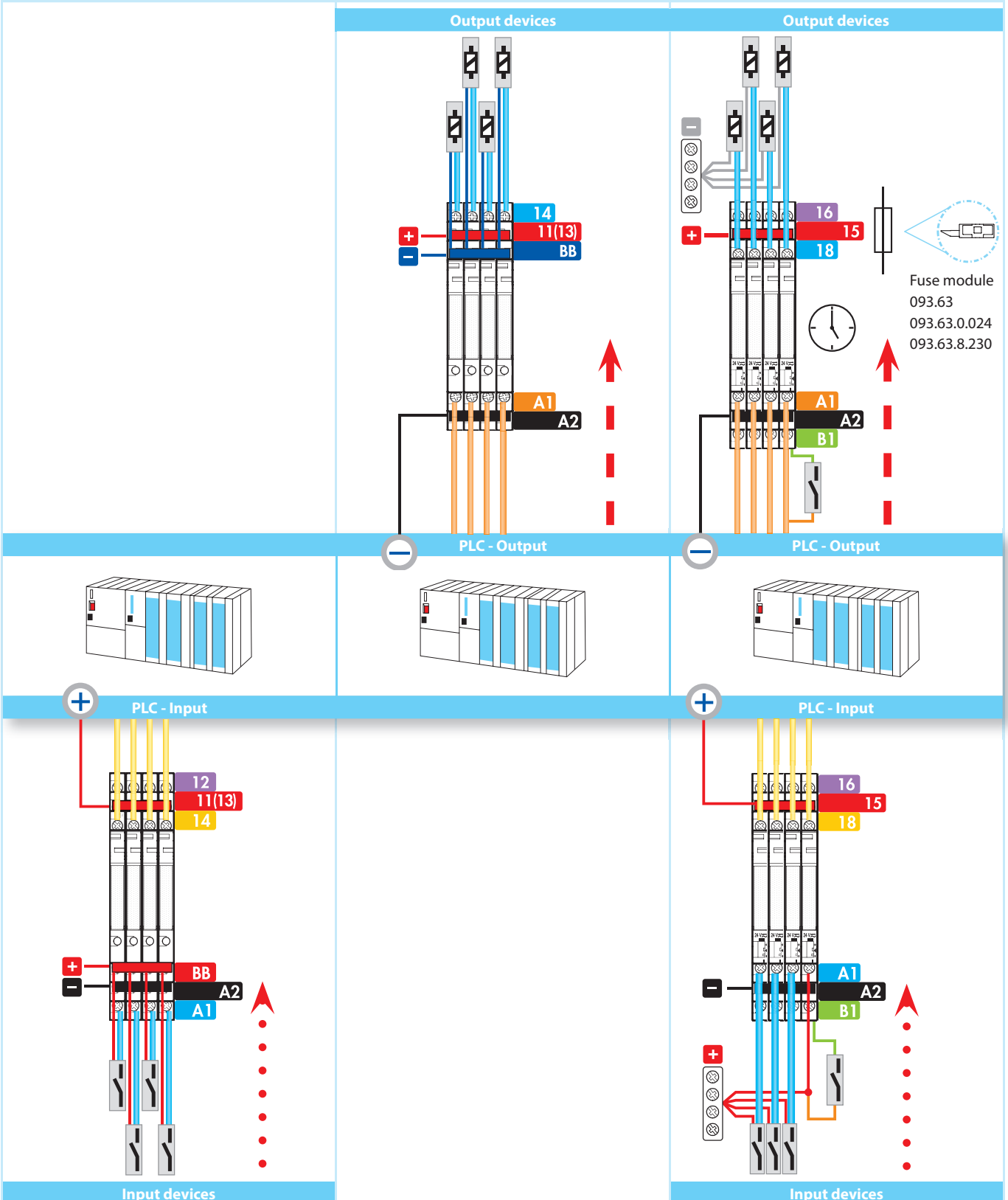

Fuse module  
093.63  
093.63.0.024  
093.63.8.230

### MasterBASIC - EMR

**1 Pole interface module, 6.2 mm wide, ideal for PLC and electronic systems**

- Common connection possible with optional jumper links (terminals A1, A2 and 11)
- UL Listing (certain relay/socket combinations)
- **Atex** compliant (Ex ec nC) option available
- **HazLoc** Class I Div. 2 Group A, B, C, D - T6 option available

B

### 39.11/39.01



- 6 A electromechanical relay
- 6 to 24 and 125 V AC/DC and 230 V AC supply
- Screw terminal and push-in terminal
- 35 mm rail (EN 60715) mounting

39.11  
Screw terminal



39.01  
Push-in terminal



\* See L39 derating diagram at page 21

For outline drawing see page 27, 28

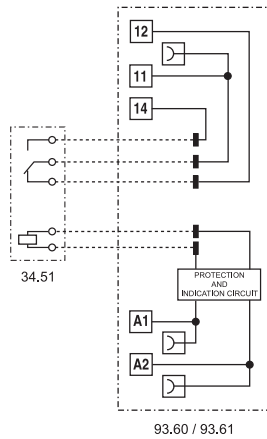

#### Contact specification

Contact configuration		1 CO (SPDT)
Rated current/ Maximum peak current	A	6/10
Rated voltage/ Maximum switching voltage	V AC	250/400
Rated load AC1	VA	1500
Rated load AC15 (230 V AC)	VA	300
Single phase motor rating (230 V AC)	kW	0.185
Breaking capacity DC1: 24/110/220 V	A	6/0.2/0.12
Minimum switching load	mW (V/mA)	500 (12/10)
Standard contact material		AgNi

#### Supply specification

Nominal voltage (U <sub>N</sub> )	V AC/DC	6 - 12 - 24 - 110...125
	V AC (50/60 Hz)	220...240
Rated power	VA (50 Hz)/W	See page 22
Operating range		(0.8...1.1)U <sub>N</sub>
Holding voltage		0.6 U <sub>N</sub>
Must drop-out voltage		0.1 U <sub>N</sub>

#### Technical data

Mechanical life AC/DC	cycles	10 · 10 <sup>6</sup>
Electrical life at rated load AC1	cycles	60 · 10 <sup>3</sup>
Operate/release time	ms	5/6
Insulation between coil and contacts (1.2/50 μs)	kV	6 (8 mm)
Dielectric strength between open contacts	V AC	1000
Ambient temperature range*	°C	-40...+70
Protection category		IP 20

**Approvals relay** (according to type)





### MasterBASIC - SSR

1 Pole interface module, 6.2 mm wide, ideal for PLC and electronic systems

- Common connection possible with optional jumper links (terminals A1, A2 and 13+)
- UL Listing (certain relay/socket combinations)
- **HazLoc** Class I Div. 2 Group A, B, C, D - T5 - T6 option available

#### 39.10/39.00



- 0.1, 2 or 6 A solid state relay
- 6 to 24 and 125 V AC/DC and 230 V AC supply
- Screw terminal and push-in terminal
- 35 mm rail (EN 60715) mounting

39.10  
Screw terminal



39.00  
Push-in terminal



\* See L39-1 and L39-2 derating diagram at page 23

For outline drawing see page 27, 28

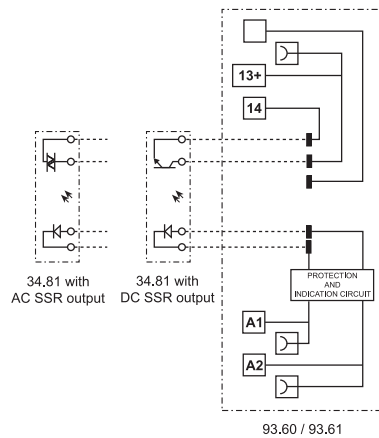

Output specification (SSR)		39.x0.x.xxx.9024	39.x0.x.xxx.7048	39.x0.x.xxx.8240
Contact configuration		1 NO (SPST-NO)		
Rated current/ Maximum peak current (10 ms)	A	6/50	0.1/0.5	2/80
Rated voltage/ Maximum blocking voltage	V	24/33 DC	48/53 DC	240/— AC
Switching voltage range	V	(1.5...33) DC	(1.5...53) DC	(12...275) AC
Repetitive peak off-state voltage	V <sub>pk</sub>	—	—	800
Minimum switching current	mA	1	0.05	35
Max. "OFF-state" leakage current	mA	0.001	0.001	1.5
Max. "ON-state" voltage drop	V	0.4	1	1.6
<b>Supply specification</b>				
Nominal voltage (U <sub>N</sub> )	V AC/DC	110...125		
	V AC (50/60 Hz)	220...240		
	V DC	6 - 12 - 24		
Rated power	VA (50 Hz)/W	See page 24		
Operating range		(0.8...1.1)U <sub>N</sub>		
Must drop-out voltage		0.1 U <sub>N</sub>		
<b>Technical data</b>				
Operate/release time	ms	0.2/0.6	0.04/0.6	12/12
Dielectric strength between input/output	V AC	3000		
Ambient temperature range*	°C	-20...+70		
Protection category		IP 20		
<b>Approvals relay</b> (according to type)				

### MasterPLUS - EMR

**1 Pole interface modules, 6.2 mm wide, ideal for PLC and electronic systems**

- Accepts output fuse module **093.63**, **093.63.0.024**, **093.63.8.230** (for 5 x 20 mm fuses) for quick and easy load protection, see page 32
- Common connection possible with optional jumper links (terminals A1, A2 and 11)
- UL Listing (certain relay/socket combinations)
- Multivoltage 24...240 V AC/DC supply version, with leakage current suppression, particularly suitable for control through long wires (for further informations see page 22)

B

#### 39.31/39.61

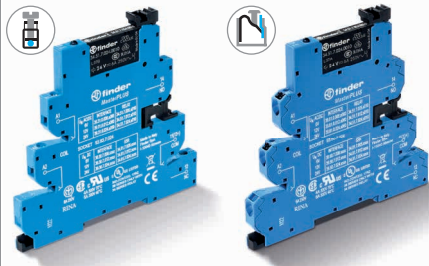

- 6 A electromechanical relay
- 6 to 125 V AC/DC, 125 and 220 V DC, 230 V AC supply
- Screw terminal and push-in terminal
- 35 mm rail (EN 60715) mounting

#### 39.31.3/39.61.3 39.31.0.240/39.61.0.240

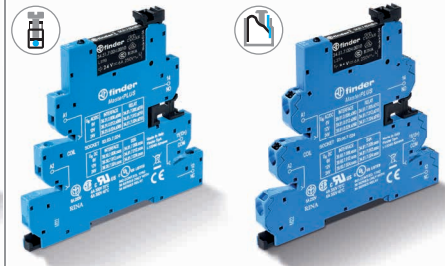

- 6 A electromechanical relay
- Leakage current suppression versions
- 125 V AC/DC, 230 V AC and multivoltage 24...240 V AC/DC supply
- Screw terminal and push-in terminal

39.31/39.31.3  
Screw terminal



39.61/39.61.3  
Push-in terminal

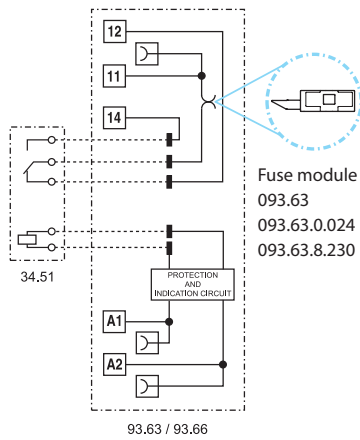

93.63 / 93.66

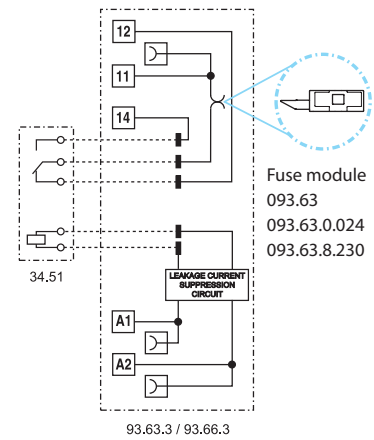

93.63.3 / 93.66.3

\* See L39 derating diagram at page 21

For outline drawing see page 27, 28

#### Contact specification

Contact configuration		1 CO (SPDT)	1 CO (SPDT)
Rated current/ Maximum peak current	A	6/10	6/10
Rated voltage/ Maximum switching voltage	V AC	250/400	250/400
Rated load AC1	VA	1500	1500
Rated load AC15 (230 V AC)	VA	300	300
Single phase motor rating (230 V AC)	kW	0.185	0.185
Breaking capacity DC1: 24/110/220 V	A	6/0.2/0.12	6/0.2/0.12
Minimum switching load	mW (V/mA)	500 (12/10)	500 (12/10)
Standard contact material		AgNi	AgNi

#### Supply specification

Nominal voltage (U <sub>N</sub> )	V AC/DC	6 - 12 - 24 - 60 - 110...125	110...125/24...240
	V AC (50/60 Hz)	220...240	220...240
	V DC	110...125 - 220	—
Rated power	VA (50 Hz)/W	See page 22	See page 22
Operating range		(0.8...1.1)U <sub>N</sub>	(0.8...1.1)U <sub>N</sub>
Holding voltage		0.6 U <sub>N</sub>	0.6 U <sub>N</sub>
Must drop-out voltage		0.1 U <sub>N</sub>	0.3 U <sub>N</sub>

#### Technical data

Mechanical life AC/DC	cycles	10 · 10 <sup>6</sup>	10 · 10 <sup>6</sup>
Electrical life at rated load AC1	cycles	60 · 10 <sup>3</sup>	60 · 10 <sup>3</sup>
Operate/release time	ms	5/6	5/6
Insulation between coil and contacts (1.2/50 μs)	kV	6 (8 mm)	6 (8 mm)
Dielectric strength between open contacts	V AC	1000	1000
Ambient temperature range*	°C	-40...+70	-40...+70
Protection category		IP 20	IP 20

Approvals relay (according to type)





### MasterPLUS - SSR

1 Pole interface modules, 6.2 mm wide, ideal for PLC and electronic systems

- Accepts output fuse module **093.63**, **093.63.0.024**, **093.63.8.230** (for 5 x 20 mm fuses) for quick and easy load protection, see page 32
- Common connection possible with optional jumper links (terminals A1, A2 and 13+)
- UL Listing (certain relay/socket combinations)
- Multivoltage 24...240 V AC/DC supply version, with leakage current suppression, particularly suitable for control through long wires (for further informations see page 24)

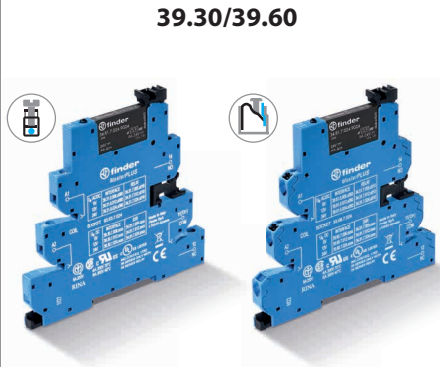

- 0.1, 2 or 6 A solid state relay
- 24 - 125 V AC/DC, 6 to 220 V DC and 230 V AC supply
- Screw terminal and push-in terminal
- 35 mm rail (EN 60715) mounting

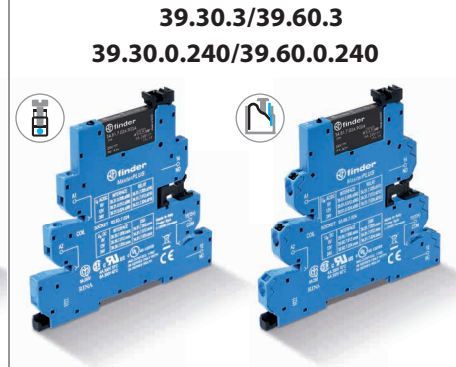

- 0.1, 2 or 6 A solid state relay
- Leakage current suppression versions
- 125 V AC/DC, 230 V AC and multivoltage 24...240 V AC/DC supply
- Screw terminal and push-in terminal

39.30/39.30.3  
Screw terminal



39.60/39.60.3  
Push-in terminal



\* See L39-1 and L39-2 derating diagram at page 23

For outline drawing see page 27, 28

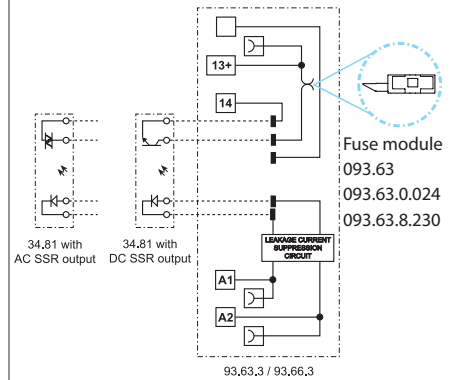
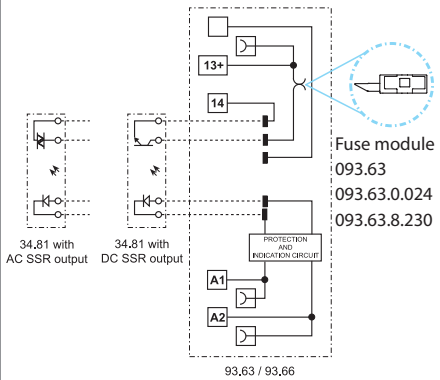

Output specification (SSR)		39.x0.x.xxx.9024	39.x0.x.xxx.7048	39.x0.x.xxx.8240	39.x0.3.xxx.9024	39.x0.3.xxx.7048	39.x0.3.xxx.8240
Contact configuration		1 NO (SPST-NO)			1 NO (SPST-NO)		
Rated current/ Maximum peak current (10 ms)	A	6/50	0.1/0.5	2/80	6/50	0.1/0.5	2/80
Rated voltage/ Maximum blocking voltage	V	24/33 DC	48/53 DC	240/— AC	24/33 DC	48/53 DC	240/— AC
Switching voltage range	V	(1.5...33) DC	(1.5...53)DC	(12...275) AC	(1.5...33) DC	(1.5...53)DC	(12...275) AC
Repetitive peak off-state voltage	V <sub>pk</sub>	—	—	800	—	—	800
Minimum switching current	mA	1	0.05	35	1	0.05	35
Max. "OFF-state" leakage current	mA	0.001	0.001	1.5	0.001	0.001	1.5
Max. "ON-state" voltage drop	V	0.4	1	1.6	0.4	1	1.6
Supply specification							
Nominal voltage (U <sub>N</sub> )	V AC/DC	24 - 110...125			110...125/24...240		
	V AC (50/60 Hz)	220...240			220...240		
	V DC	6 - 12 - 24 - 60 - 110...125 - 220			—		
Rated power	VA (50 Hz)/W	See page 24			See page 24		
Operating range		(0.8...1.1)U <sub>N</sub>			(0.8...1.1)U <sub>N</sub>		
Must drop-out voltage		0.1 U <sub>N</sub>			0.3 U <sub>N</sub>		
Technical data							
Operate/release time	ms	0.2/0.6	0.04/0.6	12/12	0.2/0.6	0.04/0.6	12/12
Dielectric strength between input/output	V AC	3000			3000		
Ambient temperature range*	°C	-20...+70			-20...+70		
Protection category		IP 20			IP 20		
Approvals relay (according to type)							

## MasterINPUT - EMR

**1 Pole interface module, 6.2 mm wide, ideal for PLC and electronic systems**

- Jumper link option for the quick and easy distribution of supply voltage to proximity switches and similar input devices (Bus-bar connection BB)
- Gold plated output contact as standard, for better compatibility with low energy PLC inputs
- UL Listing (certain relay/socket combinations)

### 39.41/39.71



- 6 A electromechanical relay
- 6 - 12 - 24 - 125 V AC/DC and 230 V AC supply
- Screw terminal and push-in terminal
- 35 mm rail (EN 60715) mounting

39.41  
Screw terminal



39.71  
Push-in terminal



\* See L39 derating diagram at page 21

For outline drawing see page 27, 28

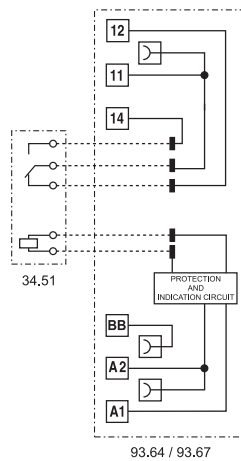

### Contact specification

Contact configuration		1 CO (SPDT)
Rated current/ Maximum peak current	A	6/10
Rated voltage/ Maximum switching voltage	V AC	250/400
Rated load AC1	VA	1500
Rated load AC15 (230 V AC)	VA	300
Single phase motor rating (230 V AC)	kW	0.185
Breaking capacity DC1: 24/110/220 V	A	6/0.2/0.12
Minimum switching load	mW (V/mA)	50 (5/2)
Standard contact material		AgNi + Au

### Supply specification

Nominal voltage ( $U_N$ )	V AC/DC	6 - 12 - 24 - 110...125
	V AC (50/60 Hz)	220...240
Rated power	VA (50 Hz)/W	See page 22
Operating range		(0.8...1.1) $U_N$
Holding voltage		0.6 $U_N$
Must drop-out voltage		0.1 $U_N$

### Technical data

Mechanical life AC/DC	cycles	$10 \cdot 10^6$
Electrical life at rated load AC1	cycles	$60 \cdot 10^3$
Operate/release time	ms	5/6
Insulation between coil and contacts (1.2/50 $\mu$ s)	kV	6 (8 mm)
Dielectric strength between open contacts	V AC	1000
Ambient temperature range*	$^{\circ}$ C	-40...+70
Protection category		IP 20

Approvals relay (according to type)



## MasterINPUT - SSR

1 Pole interface modules, 6.2 mm wide, ideal for PLC and electronic systems

- Jumper link option for the quick and easy distribution of supply voltage to proximity switches and similar input devices (Bus-bar connection BB)
- UL Listing (certain relay/socket combinations)

### 39.40/39.70

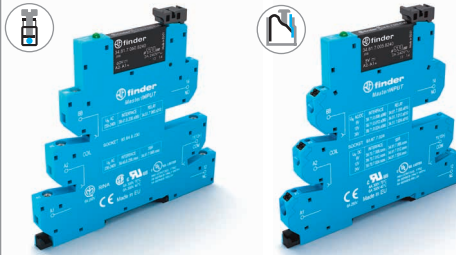

- 0.1, 2 or 6 A solid state relay
- 6 - 12 - 24 V DC, 24 - 125 V AC/DC and 230 V AC supply
- Screw terminal and push-in terminal
- 35 mm rail (EN 60715) mounting

39.40  
Screw terminal



39.70  
Push-in terminal



\* See L39-1 and L39-2 derating diagram at page 23

For outline drawing see page 27, 28

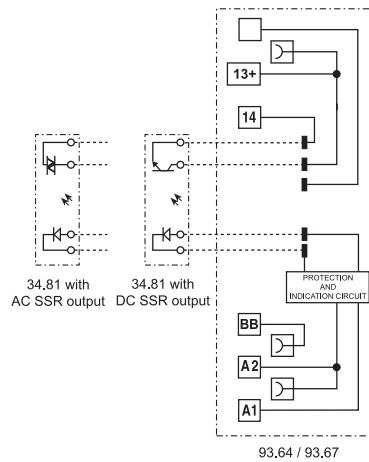

Output specification (SSR)		39.x0.x.xxx.9024	39.x0.x.xxx.7048	39.x0.x.xxx.8240
Contact configuration		1 NO (SPST-NO)		
Rated current/ Maximum peak current (10 ms)	A	6/50	0.1/0.5	2/80
Rated voltage/ Maximum blocking voltage	V	24/33 DC	48/53 DC	240/— AC
Switching voltage range	V	(1.5...33) DC	(1.5...53) DC	(12...275) AC
Repetitive peak off-state voltage	V <sub>pk</sub>	—	—	800
Minimum switching current	mA	1	0.05	35
Max. "OFF-state" leakage current	mA	0.001	0.001	1.5
Max. "ON-state" voltage drop	V	0.4	1	1.6
<b>Supply specification</b>				
Nominal voltage (U <sub>N</sub> )	V AC/DC	24 - 110...125		
	V AC (50/60 Hz)	220...240		
	V DC	6 - 12 - 24		
Rated power	VA (50 Hz)/W	See page 24		
Operating range		(0.8...1.1)U <sub>N</sub>		
Must drop-out voltage		0.1 U <sub>N</sub>		
<b>Technical data</b>				
Operate/release time	ms	0.2/0.6	0.04/0.6	12/12
Dielectric strength between input/output	V AC	3000		
Ambient temperature range*	°C	-20...+70		
Protection category		IP 20		
<b>Approvals relay</b> (according to type)				

## MasterOUTPUT - EMR

1 Pole interface modules, 6.2 mm wide, ideal for PLC and electronic systems

- Jumper link option for the quick and easy distribution of supply voltage to output side (Bus-bar connection BB) and its connection to electromagnetic valves and similar output devices
- UL Listing (certain relay/socket combinations)

B

### 39.21/39.51



- 6 A electromechanical relay
- 6 - 12 - 24 - 125 V AC/DC and 230 V AC supply
- Screw terminal and push-in terminal
- 35 mm rail (EN 60715) mounting

39.21  
Screw terminal



39.51  
Push-in terminal

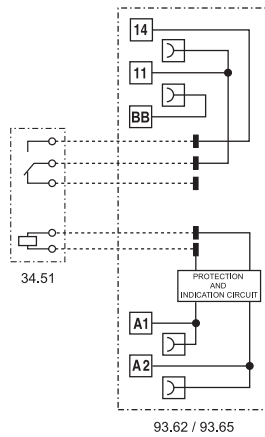

\* See L39 derating diagram at page 21

For outline drawing see page 27, 28

Contact specification		
Contact configuration		1 NO (SPST-NO)
Rated current/ Maximum peak current	A	6/10
Rated voltage/ Maximum switching voltage	V AC	250/400
Rated load AC1	VA	1500
Rated load AC15 (230 V AC)	VA	300
Single phase motor rating (230 V AC)	kW	0.185
Breaking capacity DC1: 24/110/220 V	A	6/0.2/0.12
Minimum switching load	mW (V/mA)	500 (12/10)
Standard contact material		AgNi
Supply specification		
Nominal voltage (U <sub>N</sub> )	V AC/DC	6 - 12 - 24 - 110...125
	V AC (50/60 Hz)	220...240
Rated power	VA (50 Hz)/W	See page 22
Operating range		(0.8...1.1)U <sub>N</sub>
Holding voltage		0.6 U <sub>N</sub>
Must drop-out voltage		0.1 U <sub>N</sub>
Technical data		
Mechanical life AC/DC	cycles	10 · 10 <sup>6</sup>
Electrical life at rated load AC1	cycles	60 · 10 <sup>3</sup>
Operate/release time	ms	5/6
Insulation between coil and contacts (1.2/50 μs)	kV	6 (8 mm)
Dielectric strength between open contacts	V AC	1000
Ambient temperature range*	°C	-40...+70
Protection category		IP 20
<b>Approvals relay</b> (according to type)		

## MasterOUTPUT - SSR

1 Pole interface modules, 6.2 mm wide, ideal for PLC and electronic systems

- Jumper link option for the quick and easy distribution of supply voltage to output side (Bus-bar connection BB) and its connection to electromagnetic valves and similar output devices
- UL Listing (certain relay/socket combinations)

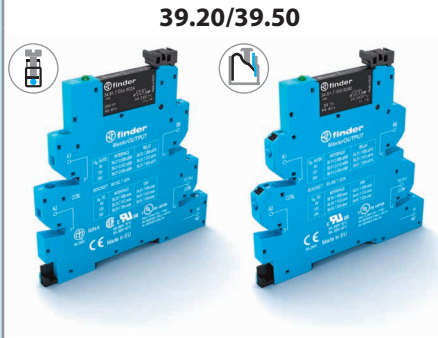

- 0.1, 2 or 6 A solid state relay
- 6 to 24 V DC, 125 V AC/DC and 230 V AC supply
- Screw terminal and push-in terminal
- 35 mm rail (EN 60715) mounting

39.20  
Screw terminal



39.50  
Push-in terminal



\* See L39-1 and L39-2 derating diagram at page 23

For outline drawing see page 27, 28

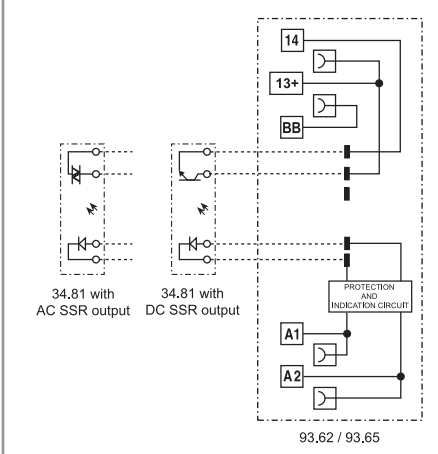

Output specification (SSR)		39.x0.x.xxx.9024	39.x0.x.xxx.7048	39.x0.x.xxx.8240
Contact configuration		1 NO (SPST-NO)		
Rated current/ Maximum peak current (10 ms)	A	6/50	0.1/0.5	2/80
Rated voltage/ Maximum blocking voltage	V	24/33 DC	48/53 DC	240/— AC
Switching voltage range	V	(1.5...33) DC	(1.5...53) DC	(12...275) AC
Repetitive peak off-state voltage	V <sub>pk</sub>	—	—	800
Minimum switching current	mA	1	0.05	35
Max. "OFF-state" leakage current	mA	0.001	0.001	1.5
Max. "ON-state" voltage drop	V	0.4	1	1.6
<b>Supply specification</b>				
Nominal voltage (U <sub>N</sub> )	V AC/DC	110...125		
	V AC (50/60 Hz)	220...240		
	V DC	6 - 12 - 24		
Rated power	VA (50 Hz)/W	See page 24		
Operating range		(0.8...1.1)U <sub>N</sub>		
Must drop-out voltage		0.1 U <sub>N</sub>		
<b>Technical data</b>				
Operate/release time	ms	0.2/0.6	0.04/0.6	12/12
Dielectric strength between input/output	V AC	3000		
Ambient temperature range*	°C	-20...+70		
Protection category		IP 20		
<b>Approvals relay</b> (according to type)				

## MasterTIMER - EMR

**Slim timed interface module, 6.2 mm wide, ideal for space-saving timing solutions in panels**

- Timer adjustment via top mounted rotary knob, accessible after assembly
- Control signal terminal
- DIP-switch for selection of 4 time scales and 8 functions
- Accepts output fuse module **093.63**, **093.63.0.024**, **093.63.8.230** (for 5 x 20 mm fuses) for quick and easy load protection, see page 32
- Common connection possible with optional jumper links (terminals A1, A2 and 15)
- UL Listing (certain relay/socket combinations)
- **Atex** compliant (Ex ec nC) option available
- **HazLoc** Class I Div. 2 Group A, B, C, D - T6 option available

### 39.81/39.91

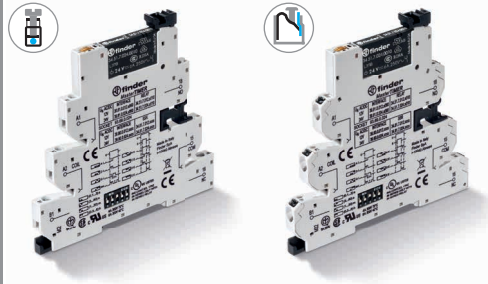

- 6 A electromechanical relay
- 12 - 24 V AC/DC supply
- Screw terminal and push-in terminal
- 35 mm rail (EN 60715) mounting

39.81  
Screw terminal



39.91  
Push-in terminal



\* See L39 derating diagram at page 21

For outline drawing see page 27, 28

#### Contact specification

Contact configuration	1 CO (SPDT)	
Rated current/ Maximum peak current	A	6/10
Rated voltage/ Maximum switching voltage	V AC	250/400
Rated load AC1	VA	1500
Rated load AC15 (230 V AC)	VA	300
Single phase motor rating (230 V AC)	kW	0.185
Breaking capacity DC1: 24/110/220 V	A	6/0.2/0.12
Minimum switching load	mW (V/mA)	500 (12/10)
Standard contact material	AgNi	

#### Supply specification

Nominal voltage (U <sub>N</sub> )	V AC/DC	12 - 24
Rated power AC/DC	VA (50 Hz)/W	See page 22
Operating range	(0.8...1.1)U <sub>N</sub>	
Holding voltage	0.6 U <sub>N</sub>	
Must drop-out voltage	0.1 U <sub>N</sub>	

#### Technical data

Specified time range	(0.1...3)s, (3...60)s, (1...20)min, (0.3...6)h	
Repeatability	%	± 1
Recovery time	ms	≤ 50
Minimum control impulse	ms	50
Setting accuracy - full range	%	5
Electrical life at rated load AC1	cycles	60 · 10 <sup>3</sup>
Ambient temperature range*	°C	-20...+50
Protection category	IP 20	

**Approvals relay** (according to type)

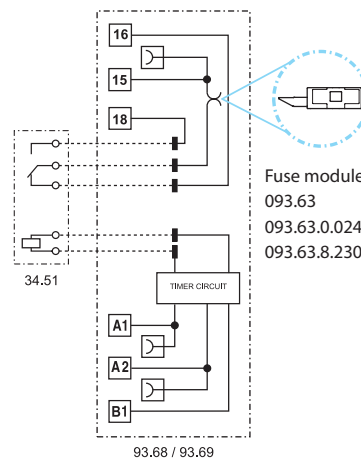

- AI:** On-delay
- DI:** Interval
- GI:** Pulse (0.5 s) delayed
- SW:** Symmetrical flasher (starting pulse on)
- BE:** Off-delay with control signal
- CE:** On- and off-delay with control signal
- DE:** Interval with control signal on
- EE:** Interval with control signal off





## MasterTIMER - SSR

**Slim timed interface module, 6.2 mm wide, ideal for space-saving timing solutions in panels**

- Timer adjustment via top mounted rotary knob; accessible after assembly
- Start terminal
- DIP-switch for selection of 4 time scales and 8 functions
- Accepts output fuse module **093.63**, **093.63.0.024**, **093.63.8.230** (for 5 x 20 mm fuses) for quick and easy load protection, see page 32
- Common connection possible with optional jumper links (terminals A1, A2 and 15+)
- UL Listing (certain relay/socket combinations)
- **HazLoc** Class I Div. 2 Group A, B, C, D - T5 - T6 option available

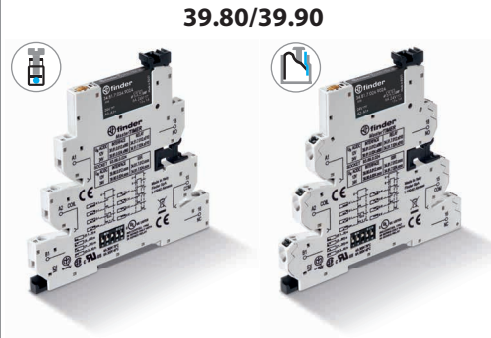

- 0.1, 2 or 6 A solid state relay
- 12 - 24 V AC/DC supply
- Screw terminal and push-in terminal
- 35 mm rail (EN 60715) mounting

39.80  
Screw terminal



39.90  
Push-in terminal



\* See L39-1 and L39-2 derating diagram at page 23

For outline drawing see page 27, 28

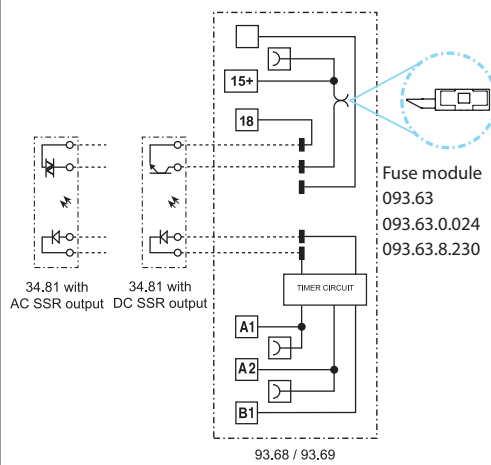

- AI:** On-delay
- DI:** Interval
- GI:** Pulse (0.5 s) delayed
- SW:** Symmetrical flasher (starting pulse on)
- BE:** Off-delay with control signal
- CE:** On- and off-delay with control signal
- DE:** Interval with control signal on
- EE:** Interval with control signal off

Output specification (SSR)		39.x0.x.xxx.9024	39.x0.x.xxx.7048	39.x0.x.xxx.8240
Contact configuration		1 NO (SPST-NO)		
Rated current/ Maximum peak current (10 ms)	A	6/50	0.1/0.5	2/80
Rated voltage/ Maximum blocking voltage	V	24/33 DC	48/53 DC	240/— AC
Switching voltage range	V	(1.5...33) DC	(1.5...53) DC	(12...275) AC
Repetitive peak off-state voltage	V <sub>pk</sub>	—	—	800
Minimum switching current	mA	1	0.05	35
Max. "OFF-state" leakage current	mA	0.001	0.001	1.5
Max. "ON-state" voltage drop	V	0.4	1	1.6
<b>Supply specification</b>				
Nominal voltage (U <sub>N</sub> )	V AC/DC	12 - 24		
Rated power	VA (50 Hz)/W	See page 24		
Operating range		(0.8...1.1)U <sub>N</sub>		
Holding voltage		0.6 U <sub>N</sub>		
Must drop-out voltage		0.1 U <sub>N</sub>		
<b>Technical data</b>				
Specified time range		(0.1...3)s, (3...60)s, (1...20)min, (0.3...6)h		
Repeatability	%	± 1		
Recovery time	ms	≤ 50		
Minimum control impulse	ms	50		
Setting accuracy - full range	%	5		
Ambient temperature range*	°C	-20...+50		
Protection category		IP 20		
<b>Approvals relay</b> (according to type)				

## MasterBASIC - EMR ATEX

1 Pole interface module, 6.2 mm wide, ideal for PLC and electronic systems

Atex compliant (Ex ec nC)

HazLoc Class I Div. 2 Group A, B, C, D - T6

- Electromechanical relay
- AC and AC/DC Version
- Screw terminal and Push-in terminal
- UL Listed
- Cadmium free contacts
- Complies with:
  - EN 60079-0: 2012 and EN 60079-15:2010
  - 94/9/CE and 2014/34/UE
- Common connection possible with optional jumper links (terminals A1, A2 and 11) and multipole connector **MasterADAPTER**
- 35 mm rail (EN 60715) mounting

### 39.11/39.01 - x073



- 1 CO 6 A
- Screw terminal and push-in terminal
- 35 mm rail (EN 60715) mounting
- ATEX compliant

39.11  
Screw terminal



39.01  
Push-in terminal

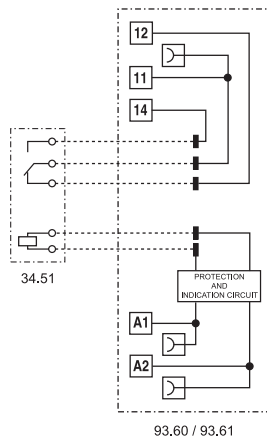

93.60 / 93.61

For outline drawing see page 27, 28

#### Contact specification

Contact configuration		1 CO (SPDT)
Rated current/ Maximum peak current	A	6/10
Rated voltage/ Maximum switching voltage	V AC	250/400
Rated load AC1	VA	1500
Rated load AC15 (230 V AC)	VA	300
Single phase motor rating (230 V AC)	kW	0.185
Breaking capacity DC1: 24/110/220 V	A	6/0.2/0.12
Minimum switching load	mW (V/mA)	500 (12/10)
Standard contact material		AgNi

#### Coil specification

Nominal voltage (U <sub>N</sub> )	V AC/DC	6 - 12 - 24 - 110...125 - 24...240
	V AC (50/60 Hz)	230...240
Rated power AC/DC	VA (50 Hz)/W	See page 22
Operating range		(0.8...1.1)U <sub>N</sub>
Holding voltage		0.6 U <sub>N</sub>
Must drop-out voltage		0.1 U <sub>N</sub>

#### Technical data

Mechanical life AC/DC	cycles	10 · 10 <sup>6</sup>
Electrical life at rated load AC1	cycles	60 · 10 <sup>3</sup>
Operate/release time	ms	5/6
Insulation between coil and contacts (1.2/50 μs)	kV	6 (8 mm)
Dielectric strength between open contacts	V AC	1000
Ambient temperature range	°C	-40...+70
Protection category		IP 20

Approvals relay (according to type)





## Ordering information

Example: *MasterPLUS* 39 series screw terminal interface module, electromechanical relay output, 1 CO (SPDT), 24 V AC/DC coil.

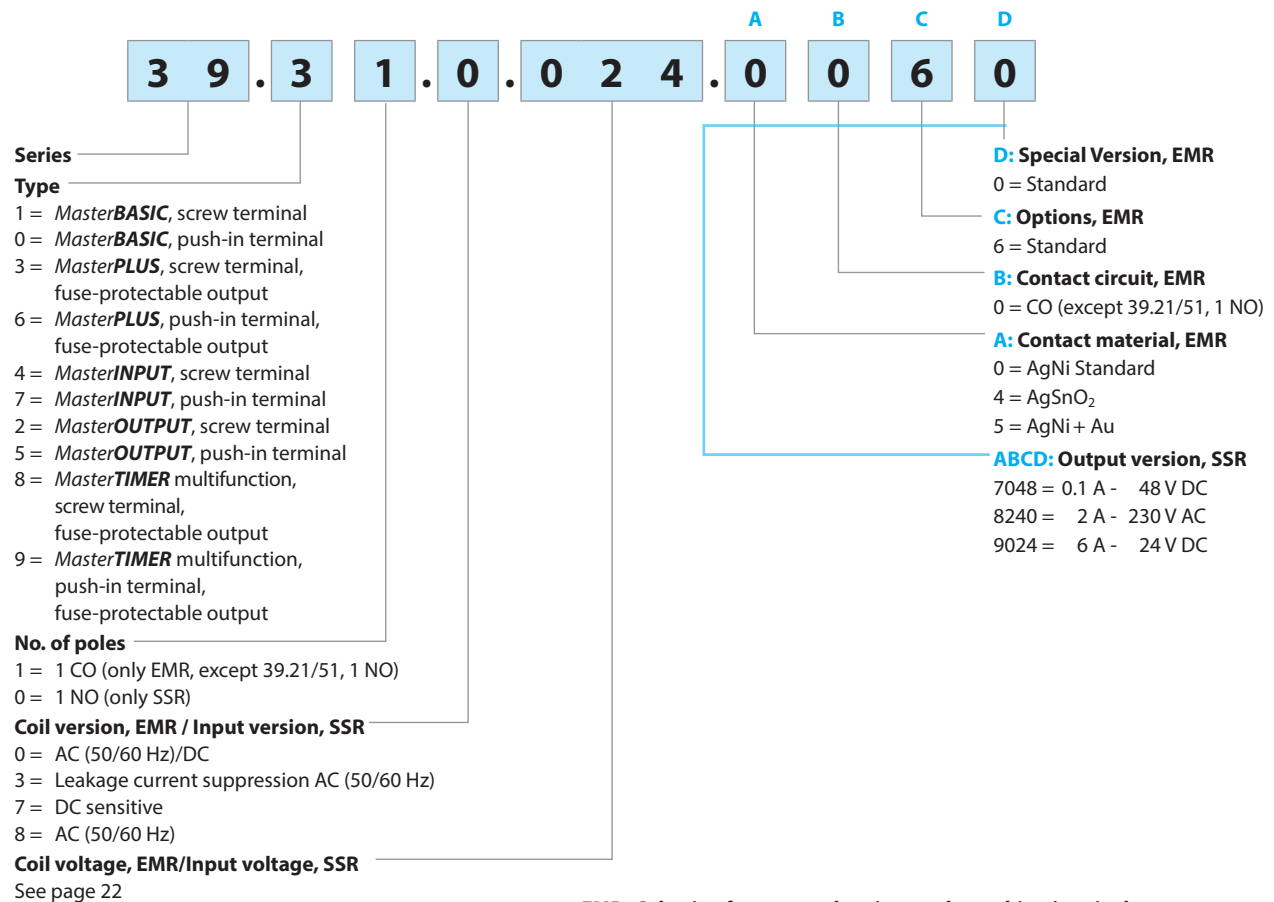

**EMR - Selecting features and options: only combinations in the same row are possible.**  
 Preferred selections for best availability are shown in **bold**.

Type	Coil version	A	B	C	D
39.11/01	0.006 - 0.012	0 - 4 - 5	0	6	0
	<b>0.024</b> - 0.125 - <b>8.230</b>				
39.31/61	0.006 - 0.012	0 - 4 - 5	0	6	0
	<b>0.024</b> - 0.060				
	0.125 - 0.240 - <b>8.230</b>				
	7.125 - 7.220				
39.41/71	0.006 - 0.012	0 - 4 - 5	0	6	0
	<b>0.024</b> - 0.125				
	<b>8.230</b>				
39.21/51	0.006 - 0.012	0 - 4 - 5	0	6	0
	<b>0.024</b> - 0.125				
	<b>8.230</b>				
39.81/91	0.012 - <b>0.024</b>	0	0	6	0

**SSR - Selecting features and options: only combinations in the same row are possible.**  
 Preferred selections for best availability are shown in **bold**.

Type	Input version	Output version, ABCD
39.10/00	7.006 - 7.012	7048 - 8240 - <b>9024</b>
	<b>7.024</b> - 0.125 - <b>8.230</b>	
39.30/60	7.006 - 7.012	7048 - 8240 - <b>9024</b>
	<b>7.024</b> - 7.060	
	7.125 - 7.220	
	0.024 - 0.125 - 0.240	
	<b>8.230</b>	
39.40/70	7.006 - 7.012	7048 - 8240 - <b>9024</b>
	<b>7.024</b> - 0.024 - 0.125	
	<b>8.230</b>	
39.20/50	7.006 - 7.012	7048 - 8240 - <b>9024</b>
	<b>7.024</b> - 0.125	
	<b>8.230</b>	
39.80/90	0.012 - <b>0.024</b>	7048 - 8240 - <b>9024</b>

## Technical data

### Insulation according to EN 61810-1

Nominal voltage of supply system	V AC	230/400	
Rated insulation voltage	V AC	250	400
Pollution degree		3	2

### Insulation between coil and contact set

Type of Insulation		Reinforced
Overvoltage category		III
Rated impulse voltage	kV (1.2/50) $\mu$ s	6
Dielectric strength	V AC	4000

### Insulation between open contacts (EMR)

Type of disconnection		Micro-disconnection
Dielectric strength	V AC/kV (1.2/50) $\mu$ s	1000/1.5

### Conducted disturbance immunity

		$U_N \leq 60 \text{ V}$	$U_N = 125 \text{ V}$	$U_N = 230 \text{ V}$
Fast transients (burst 5/50 ns, 5 kHz) according to EN 61000-4-4 at supply terminals	kV	4	4	4
Voltage pulses (surge 1.2/50 $\mu$ s) according to EN 61000-4-5 at supply terminals (differential mode)	kV	0.8	2	4

### Other data

Bounce time (EMR): NO/NC	ms	1/6	
Vibration resistance (EMR, 10...55 Hz): NO/NC	g	10/15	
Power lost to the environment	without contact current	W	0.2 (24 V) - 0.4 (230 V)
	with rated current	W	0.6 (24 V) - 0.9 (230 V)

### Terminals

		Screw terminal	Push-in terminal
Wire strip length	mm	10	8
 Screw torque	Nm	0.5	—
		Solid and stranded cable	Solid and stranded cable
Min. wire size	mm <sup>2</sup>	1 x 0.5	1 x 0.5
	AWG	1 x 21	1 x 21
Max. wire size	mm <sup>2</sup>	1 x 2.5	1 x 2.5
	AWG	1 x 14	1 x 14

### Ordering information ATEX - HazLoc versions

Example: 39 series, screw terminals interface module, electromechanical relay output, 1 CO 6 A, 24 V AC/DC, ATEX - HazLoc version.

<p><b>3 9 . 1 1 . 0 . 0 2 4 . 0 0 7 3</b></p>	<p><b>A B C D</b></p>	
<p><b>Series</b></p> <p><b>Type</b> 0 = Push-in terminals 35 mm rail (EN 60715) mount 1 = Screw terminals 35 mm rail (EN 60715) mount 8 = TIMER multifunction, screw terminal 9 = TIMER multifunction, push-in terminal</p> <p><b>No. of poles</b> 0 = 1 NO (only SSR) 1 = 1 CO, 6 A</p> <p><b>Coil version</b> 0 = AC/DC 8 = AC (50/60 Hz)</p> <p><b>Coil voltage</b> See coil specifications</p>	<p><b>A - B: Contact material - circuit</b> 00 = EMR AgNi contact CO (nPDT) Up to 6 A 250 V AC ATEX and Hazloc compliant 50 = EMR AgNi + Au contact CO (nPDT) Up to 6 A 250 V AC ATEX and Hazloc compliant 82 = SSR NO (SPST-NO) Up to 0.75 A - 277 V AC HazLoc compliant 90 = SSR NO (SPST-NO) Up to 5 A - 24 V DC HazLoc compliant</p>	<p><b>C - D: Option</b> 73 = Atex (Ex ec nC) and HazLoc Class I Div. 2 interface with EMR relay, or HazLoc Class I Div. 2 interface with SSR relay</p>



### ATEX - Electrical characteristics

Max current @ 70 °C	Single piece mount	> 8 piece mount
Type 39.11/01	A 6	5
Type 39.11/01 (110...125)V AC/DC only	A 6	4
Terminals	Screw terminals	Push-in Terminals
Wire strip length	mm 10	8
Screw torque	Nm 0.5	—
Min. wire size	solid and stranded cable	solid and stranded cable
	mm <sup>2</sup> 0.5	0.5
	AWG 21	21
Max. wire size	solid and stranded cable	solid and stranded cable
	mm <sup>2</sup> 1 x 2.5	1 x 2.5
	AWG 1 x 14	1 x 14

### Markings - ATEX versions - ATEX, II 3G Ex ec nC IIC Gc

<b>MARKING</b>	
	Specific marking of explosion protection
<b>II</b>	Component for surface plant (different from mines)
<b>3</b>	Category 3: normal level of protection
<b>GAS</b>	<b>G</b> Explosive atmosphere due to presence of combustible gas vapour or mist
	<b>Ex ec</b> Increased safety
	<b>Ex nC</b> Sealed device (type of protection for category 3G)
	<b>IIC</b> Gas group
	<b>Gc</b> Equipment Protection Level
-40 °C ≤ Ta ≤ +70 °C Ambient temperature	
<b>EPTI 17 ATEX 0303 U</b> EPTI: laboratory which issues the CE type certificate 17: year of issue of certificate 0303: number of CE type certificate U: ATEX component	

I-2023, www.findernet.com

## Markings - Hazardous Location Class I Div. 2 Groups A, B, C, D - T5 - T6 and other data

HazLoc Class I Div. 2 Group A, B, C, D - T5 - T6		Meaning
Class I		Areas in which flammable gases and vapours may be present
Div. 2		Low probability to find ignitable concentration of hazards because are typically present in containers or closed systems from which can escape through their accidental rupture or breakdown
Group A, B, C, D		Kind of combustible, flammable gases and vapours can be in the atmosphere
Permissible Surface temperature		
T5	100 °C	212 °F
T6	85 °C	185 °F

Interface Code	Temperature code @ 40°C	40°C		Temperature code @ 70°C	70°C	
		Current	Voltage		Current	Voltage
39.11.0.024.0073	T6	6 A (NO)	250 V AC	—	—	—
39.10.0.024.8273	T5	0.75 A	277 V AC	—	—	—
39.10.0.024.9073	T6	5 A	24 V DC	T5	4 A	24 V DC
39.11.8.230.0073	T6	6 A (NO)	250 V AC	—	—	—
39.10.8.230.8273	T5	0.75 A	277 V AC	—	—	—
39.10.8.230.9073	T6	5 A	24 V DC	T5	4 A	24 V DC
39.01.0.240.0073	T6	6 A (NO)	250 V AC	—	—	—
39.00.0.240.8273	T5	0.75 A	277 V AC	—	—	—
39.00.0.240.9073	T6	5 A	24 V DC	T5	4 A	24 V DC
39.11.7.024.0073	T6	6 A (NO)	250 V AC	—	—	—
39.11.7.024.8273	T5	0.75 A	277 V AC	—	—	—
39.10.7.024.9073	T6	5 A	24 V DC	T5	4 A	24 V DC
39.91.0.024.0073	T6	6 A (NO)	250 V AC	—	—	—
39.90.0.024.8273	T5	0.75 A	277 V AC	—	—	—
39.90.0.024.9073	T6	5 A	24 V DC	T5	4 A	24 V DC

### Contact specification- Electromechanical Relay

F 39 - Electrical life (AC) v contact current

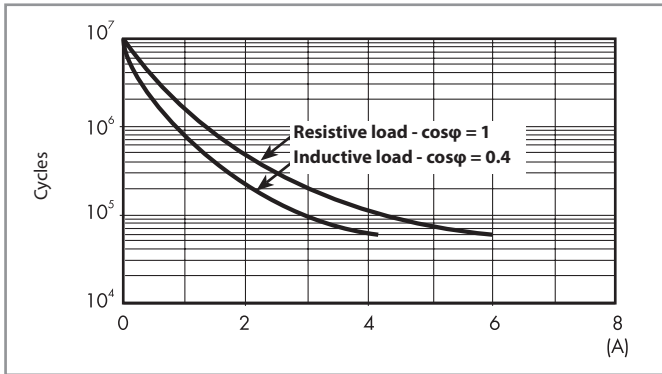

H 39 - Maximum DC1 breaking capacity

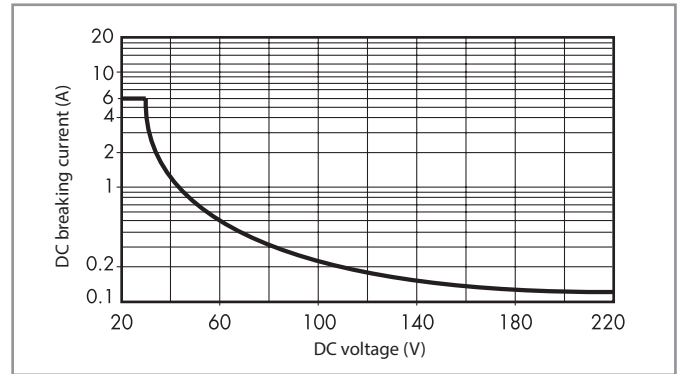

- When switching a resistive load (DC1) having voltage and current values under the curve, an electrical life of  $\geq 60 \cdot 10^3$  can be expected.
- In the case of DC13 loads, the connection of a diode in parallel with the load will permit a similar electrical life as for a DC1 load.  
Note: the release time for the load will be increased.

L 39 - Output current v ambient temperature

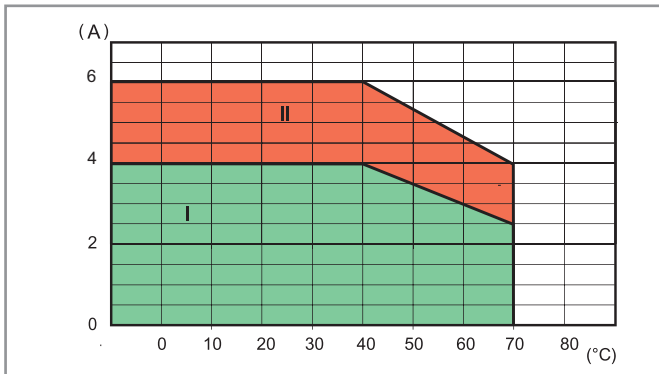

- I: 39 series installed as a group (without gap between sockets) with fuse module inserted
- II: 39 series installed as a group with "bridging" module, or individually with fuse module

## Coil specifications - Electromechanical Relay

### Coil data DC, type 39.31/61

Nominal voltage $U_N$	Coil code	Operating range		Must drop-out voltage $U_r$	Rated input current at $U_N$ $I_N$	Rated power at $U_N$ at $U_N$
		$U_{min}$	$U_{max}$			
V		V	V	V	mA	W
125 (110...125)	7.125	88	138	12.5	4.6	0.6
220	7.220	176	242	22	3.0	0.6

### Coil data AC/DC, type 39.11/21/31/41/01/51/61/71

Nominal voltage $U_N$	Coil code	Operating range		Must drop-out voltage $U_r$	Rated input current at $U_N$ $I_N$	Rated power at $U_N$ at $U_N$
		$U_{min}$	$U_{max}$			
V		V	V	V	mA	VA/W
6	0.006	4.8	6.6	0.6	35	0.2/0.2
12	0.012	9.6	13.2	1.5	15	0.2/0.2
24	0.024	19.2	26.4	2.4	11	0.25/0.25
60 <sup>(1)</sup>	0.060	48	66	6.0	5.7	0.35/0.35
125 (110...125)	0.125	88	138	12.5	5.6	0.7/0.7
240 (24...240) <sup>(2)</sup>	0.240	20.4	264	2.4	19	1.5/0.3

<sup>(1)</sup> 60 V AC/DC for type 39.31/61 only

<sup>(2)</sup> 24...240 V AC/DC for type 39.31/61 only with leakage current suppression function.

### Coil data AC, type 39.11/21/31/41/01/51/61/71

Nominal voltage $U_N$	Coil code	Operating range		Must drop-out voltage $U_r$	Rated input current at $U_N$ $I_N$	Rated power at $U_N$ at $U_N$
		$U_{min}$	$U_{max}$			
V		V	V	V	mA	VA/W
230 (230...240)	8.230	184	264	23	4.3	1/0.4

### Coil data leakage current suppression versions, type 39.31.3/61.3

Nominal voltage $U_N$	Coil code	Operating range		Must drop-out voltage $U_r$	Rated input current at $U_N$ $I_N$	Rated power at $U_N$ at $U_N$
		$U_{min}$	$U_{max}$			
V		V	V	V	mA	VA/W
125 (110...125)	3.125	88	138	44	8.4	1.1/1
230 (230...240)	3.230	184	264	72	5.9	1.4/0.5

The 39 Series interface modules (supply version 3) have built-in leakage current suppression to address industry concerns of the contacts not dropping-out when there is residual current in the circuit; at (110...125)V AC/DC and (230...240)V AC.

This problem can occur, for example, when connecting the interface modules to PLC's with triac outputs or when connecting via relatively long cables.

### Coil data AC/DC timer, type 39.81/91

Nominal voltage $U_N$	Coil code	Operating range (AC/DC)		Must drop-out voltage $U_r$	Rated input current at $U_N$		Rated power at $U_N$	
		$U_{min}$	$U_{max}$		DC	AC	DC	AC
V		V	V	V	mA	mA	W	VA/W
12	0.012	9.6	13.2	1.2	15	23	0.2	0.3/0.2
24	0.024	19.2	26.4	2.4	11	19	0.25	0.4/0.3

### Output specification - Solid State Relays

**L 39-1 - Output DC current v ambient temperature**

39.xx.x.xxx.9024

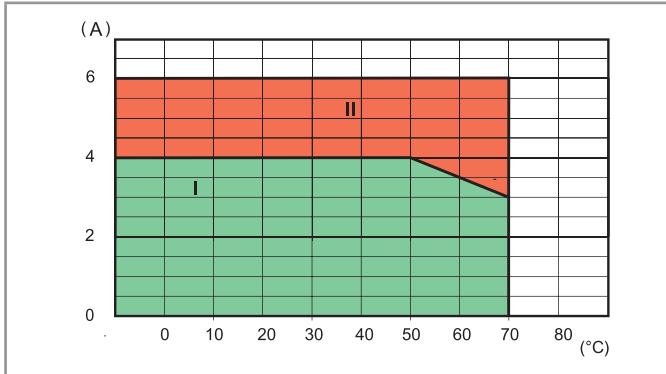

**L 39-2 - Output AC current v ambient temperature**

39.xx.x.xxx.8240

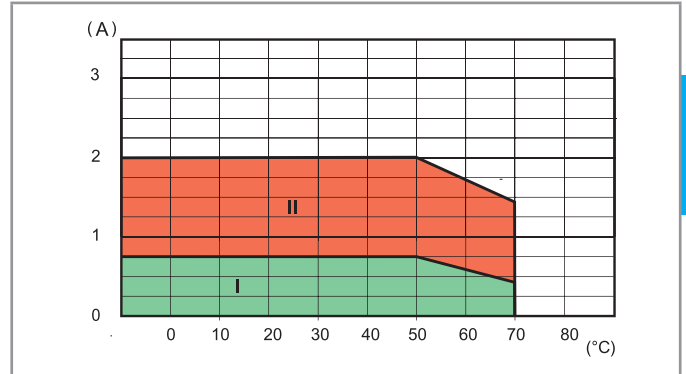

**I:** SSR installed as a group (without gap between sockets)

**II:** SSR installed individually in free air, or with a gap  $\geq 9$  mm, which implies a not significant influence from nearby components

**Max recommended switching frequency** (Cycles/Hour, with 50% Duty-cycle) at ambient temperature 50°C, single mounting

Load	39.xx.x.xxx.9024	39.xx.x.xxx.8240	39.xx.x.xxx.7048
24 V 6 A DC I	180 000	—	—
24 V 3 A DC L/R = 10 ms	5000	—	—
24 V 2 A DC L/R = 40 ms	3600	—	—
24 V 1 A DC L/R = 40 ms	6500	—	—
24 V 0.8 A DC L/R = 40 ms	9000	—	—
24 V 1.5 A DC L/R = 80 ms	3250	—	—
230 V 2 A AC I	—	60 000	—
230 V 1.25 A AC15	—	3600	—
48 V 0.1 A DC I	—	—	60 000

## Input specifications - Solid State Relay

### Input data DC, type 39.10/20/30/40/00/50/60/70

Nominal voltage $U_N$	Input code	Operating range		Must drop-out voltage $U_r$	Rated input current at $U_N$ $I_N$	Rated power at $U_N$ W
		$U_{min}$	$U_{max}$			
V		V	V	V	mA	
6	7.006	4.8	6.6	0.6	7.5	0.2
12	7.012	9.6	13.2	1.2	20.7	0.25
24	7.024	19.2	26.4	2.4	10.5	0.25
60 <sup>(1)</sup>	7.060	38	66	6.0	6.4	0.4
125 <sup>(1)</sup> (110...125)	7.125	88	138	12.5	4.6	0.6
220 <sup>(1)</sup>	7.220	176	242	22	3.0	0.6

<sup>(1)</sup> 60 V DC, 125 V DC and 220 V DC for type 39.30/60 only

### Input data AC/DC, type 39.10/20/30/40/00/50/60/70

Nominal voltage $U_N$	Input code	Operating range		Must drop-out voltage $U_r$	Rated input current at $U_N$ $I_N$	Rated power at $U_N$ VA/W
		$U_{min}$	$U_{max}$			
V		V	V	V	mA	
24 <sup>(2)</sup>	0.024	19.2	26.4	2.4	17.5	0.4/0.3
125 (110...125)	0.125	88	138	12.5	5.5	0.7/0.7
240 (24...240) <sup>(3)</sup>	0.240	20.4	264	2.4	17.5	1.5/0.3

<sup>(2)</sup> 24 V AC/DC for type 39.30/40/60/70 only

<sup>(3)</sup> 24...240 V AC/DC for type 39.30/60 only with leakage current suppression function.

### Input data AC, type 39.10/20/30/40/00/50/60/70

Nominal voltage $U_N$	Input code	Operating range		Must drop-out voltage $U_r$	Rated input current at $U_N$ $I_N$	Rated power at $U_N$ VA/W
		$U_{min}$	$U_{max}$			
V		V	V	V	mA	
230 (230...240)	8.230	184	264	23	4.2	1/0.4

### Input data leakage current suppression versions, type 39.30.3/60.3

Nominal voltage $U_N$	Input code	Operating range		Must drop-out voltage $U_r$	Rated input current at $U_N$ $I_N$	Rated power at $U_N$ VA/W
		$U_{min}$	$U_{max}$			
V		V	V	V	mA	
125 (110...125)	3.125	88	138	44	8.4	1.1/1
230 (230...240)	3.230	184	264	72	5.9	1.4/0.5

The 39 Series interface modules (supply version 3) have built-in leakage current suppression to address industry concerns of the contacts not dropping-out when there is residual current in the circuit; at (110...125)V AC/DC and (230...240)V AC.

This problem can occur, for example, when connecting the interface modules to PLC's with triac outputs or when connecting via relatively long cables.

### Input data AC/DC timer, type 39.80/90

Nominal voltage $U_N$	Input code	Operating range (AC/DC)		Must drop-out voltage $U_r$	Rated input current at $U_N$		Rated power at $U_N$	
		$U_{min}$	$U_{max}$		DC mA	AC mA	DC W	AC VA/W
V		V	V	V	mA	mA	W	VA/W
12	0.012	9.6	13.2	1.2	15	23	0.2	0.3/0.2
24	0.024	19.2	26.4	2.4	11	19	0.25	0.4/0.3



## Timer specifications

EMC specifications			
Type of test		Reference standard	
Electrostatic discharge	contact discharge	EN 61000-4-2	4 kV
	air discharge	EN 61000-4-2	8 kV
Radio-frequency electromagnetic field	(80 ÷ 1000 MHz)	EN 61000-4-3	10 V/m
	(1400 ÷ 2700 MHz)	EN 61000-4-3	10 V/m
Fast transients (burst) (5-50 ns, 5 and 100 kHz)	on Supply terminals	EN 61000-4-4	4 kV
	on control signal terminals	EN 61000-4-4	4 kV
Surges (1.2/50 µs) on supply and control signal terminals	common mode	EN 61000-4-5	2 kV
	differential mode	EN 61000-4-5	0.8 kV
Radio-frequency common mode (0.15 ÷ 80 MHz)	on Supply terminals	EN 61000-4-6	10 V
	on control signal terminals	EN 61000-4-6	3 V
Radiated and conducted emission		EN 55022	class B

Other data			
Bounce time (EMR): NO/NC	ms	1/6	
Vibration resistance (EMR, 10...55 Hz): NO/NC	g	10/15	
Power lost to the environment	without contact current	W	0.3
	with rated current	W	0.8

Terminals			
		Screw terminal	Push-in terminal
Wire strip length	mm	10	8
Screw torque	Nm	0.5	—
		Solid and stranded cable	Solid and stranded cable
Min. wire size	mm <sup>2</sup>	1 x 0.5	1 x 0.5
	AWG	1 x 21	1 x 21
Max. wire size	mm <sup>2</sup>	1 x 2.5	1 x 2.5
	AWG	1 x 14	1 x 14

## Times scales



## Functions

LED	Supply voltage	NO contact/output
	OFF	Open
	ON	Open
	ON	Open (timing to close in progress)
	ON	Closed

Wiring diagram

U = Supply voltage

S = Signal switch

= Output contact

Without control signal

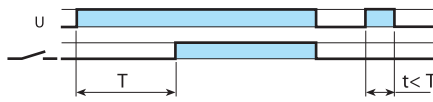
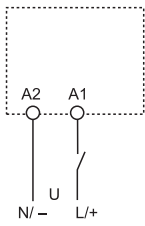

**(AI) On-delay**  
Apply power to timer. Output contacts transfer after preset time has elapsed. Reset occurs when power is removed.

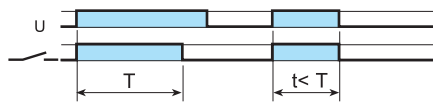

**(DI) Interval**  
Apply power to timer. Output contacts transfer immediately. After the preset time has elapsed, contacts reset.



**(GI) Pulse (0.5 s) delayed**  
Apply power to timer. Output contacts transfer after preset time has elapsed. Reset occurs after a fixed time of 0.5 s.

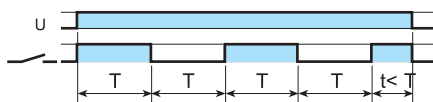

**(SW) Symmetrical flasher (starting pulse on)**  
Apply power to timer. Output contacts transfer immediately and cycle between ON and OFF for as long as power is applied. The ratio is 1:1 (time on = time off).

With control signal

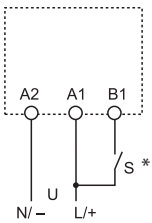

\* With DC supply, positive polarity has to be connected to B1, terminal (according to EN 60204-1).

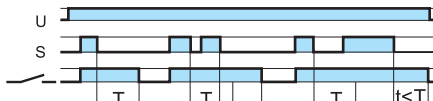

**(BE) Off-delay with control signal**  
Power is permanently applied to the timer. The output contacts transfer immediately on closure of the Signal Switch (S). Opening the Signal Switch initiates the preset delay, after which time the output contacts reset.

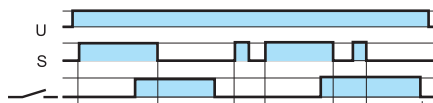

**(CE) On- and off-delay with control signal**  
Power is permanently applied to the timer. Closing the Signal Switch (S) initiates the preset delay, after which time the output contacts transfer. Opening the Signal Switch initiates the same preset delay, after which time the output contacts reset.

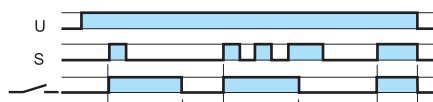

**(DE) Interval with control signal on**  
Power is permanently applied to the timer. On momentary or maintained closure of Signal Switch (S), the output contacts transfer, and remain so for the duration of the preset delay, after which they reset.

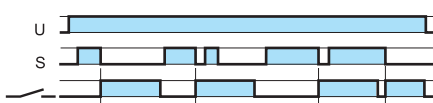

**(EE) Interval with control signal off**  
Power is permanently applied to the timer. On opening of the Signal Switch (S) the output contacts transfer, and remain so for the duration of the preset delay, after which they reset.

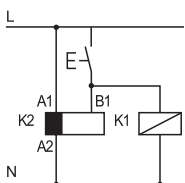

• Possible to control an external load, such as another relay coil or timer, connected to the control signal terminal B1.

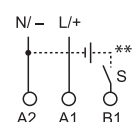

\*\* A voltage other than the supply voltage can be applied to the command Start (B1), example:  
A1 - A2 = 24 V AC  
B1 - A2 = 12 V DC

Outline drawings - Screw terminal sockets

Types 39.10/39.20  
39.11/39.21  
Screw terminal

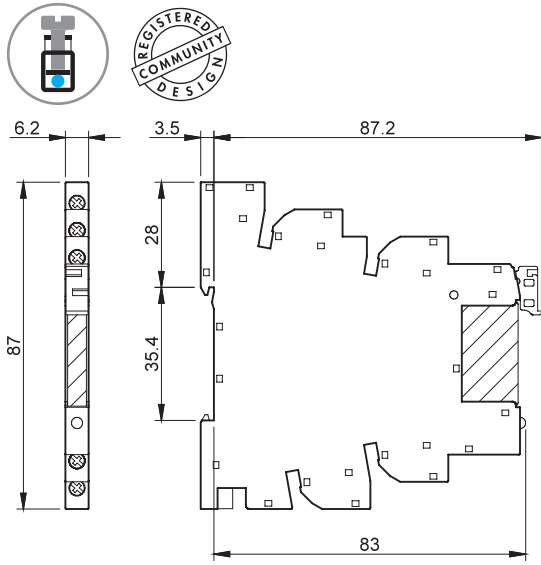

Types 39.30/39.30.3  
39.31/39.31.3  
Screw terminal

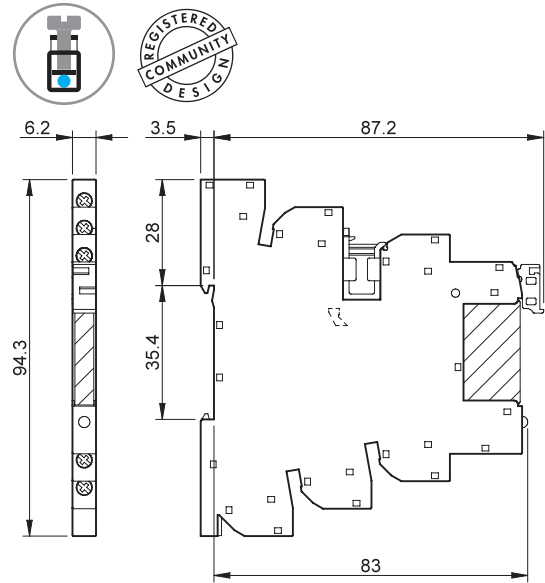

Types 39.40  
39.41  
Screw terminal

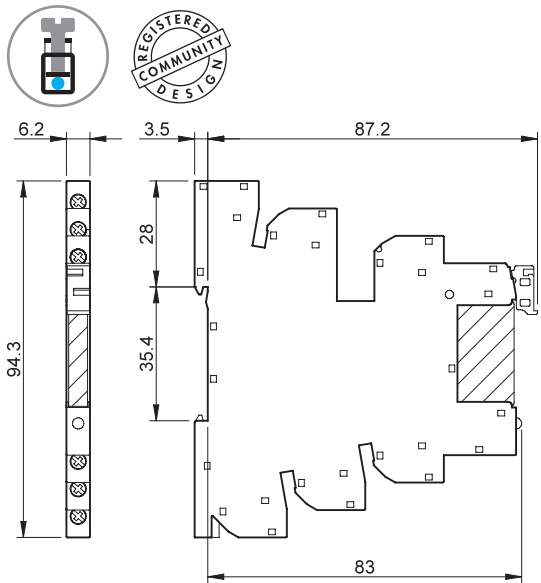

Types 39.80  
39.81  
Screw terminal

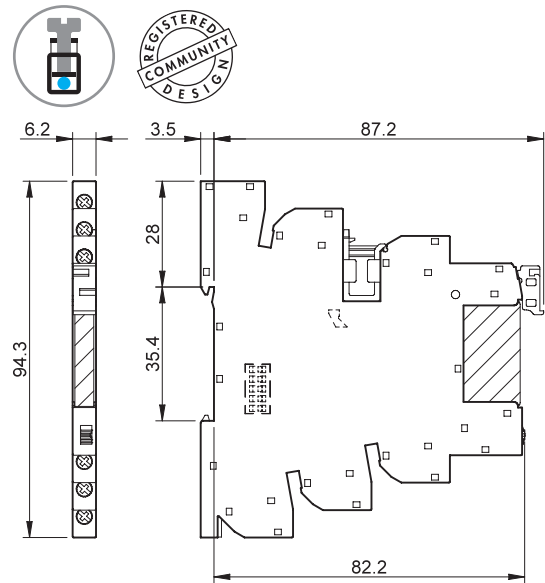

B

## Outline drawings - Push-in terminal sockets

Types 39.00/39.01  
39.50/39.51  
Push-in terminal

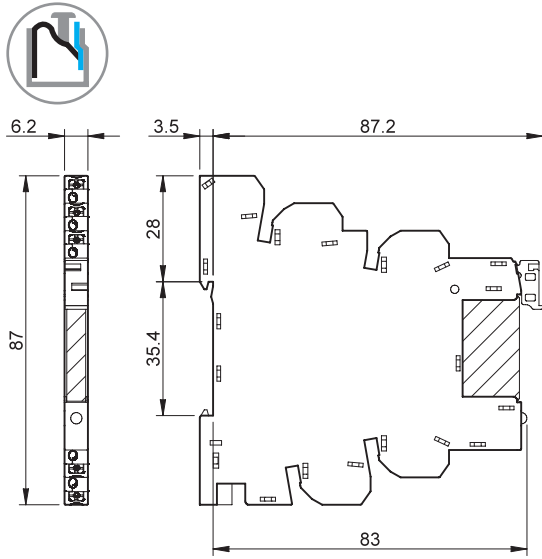

Types 39.60/39.60.3  
39.61/39.61.3  
Push-in terminal

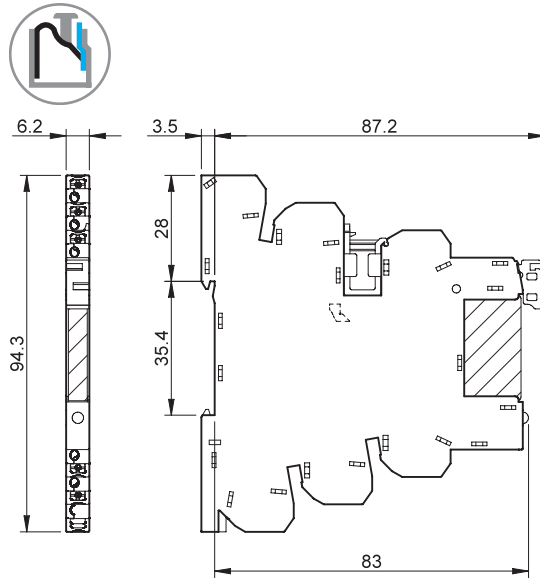

Types 39.70  
39.71  
Push-in terminal

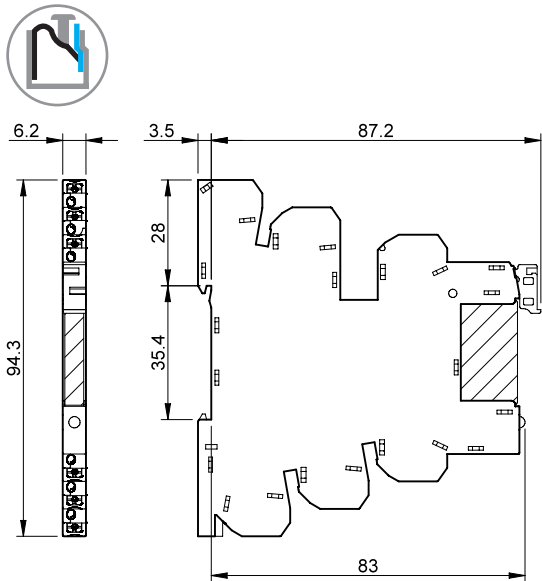

Types 39.90  
39.91  
Push-in terminal

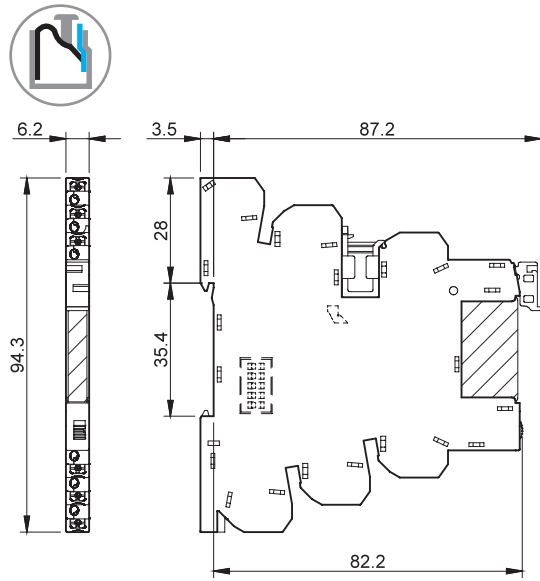

## Main features

### Push-in terminals

The push-in terminals permit the quick connection of solid wires or ferrules by their simple insertion into the terminal (A). It is possible to open the terminal to extract the wire by first pushing down on the push-button using a screwdriver (C). For stranded cable it is necessary first to open the terminal using the push button, both for the extraction (C) and insertion (B). It is possible at any time to check the connection via the test aperture, using a 2 mm diameter test probe (D).

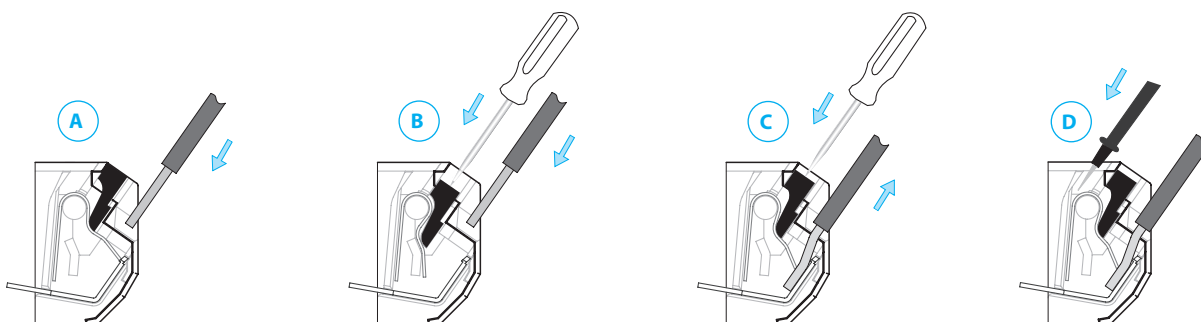

## Electromechanical Relay (1 Pole 6 A) & Screw Socket Combinations

Interface Module Code	Coil voltage	Relay	Socket
<b>MasterBASIC</b>			
39.11.0.006.0060	6 V AC/DC	34.51.7.005.0010	93.61.7.024
39.11.0.012.0060	12 V AC/DC	34.51.7.012.0010	93.61.7.024
39.11.0.024.0060	24 V AC/DC	34.51.7.024.0010	93.61.7.024
39.11.0.125.0060	(110...125)V AC/DC	34.51.7.060.0010	93.61.0.125
39.11.8.230.0060	(230...240)V AC	34.51.7.060.0010	93.61.8.230
<b>MasterPLUS</b>			
39.31.0.006.0060	6 V AC/DC	34.51.7.005.0010	93.63.7.024
39.31.0.012.0060	12 V AC/DC	34.51.7.012.0010	93.63.7.024
39.31.0.024.0060	24 V AC/DC	34.51.7.024.0010	93.63.7.024
39.31.0.060.0060	60 V AC/DC	34.51.7.060.0010	93.63.7.060
39.31.0.125.0060	(110...125)V AC/DC	34.51.7.060.0010	93.63.0.125
39.31.0.240.0060	(24...240)V AC/DC	34.51.7.024.0010	93.63.0.240
39.31.8.230.0060	(230...240)V AC	34.51.7.060.0010	93.63.8.230
39.31.7.125.0060	(110...125)V DC	34.51.7.060.0010	93.63.7.125
39.31.7.220.0060	220 V DC	34.51.7.060.0010	93.63.7.220
39.31.3.125.0060	(110...125)V AC/DC	34.51.7.060.0010	93.63.3.125
39.31.3.230.0060	(230...240)V AC	34.51.7.060.0010	93.63.3.230
<b>MasterINPUT</b>			
39.41.0.006.5060	6 V AC/DC	34.51.7.005.5010	93.64.7.024
39.41.0.012.5060	12 V AC/DC	34.51.7.012.5010	93.64.7.024
39.41.0.024.5060	24 V AC/DC	34.51.7.024.5010	93.64.7.024
39.41.0.125.5060	(110...125)V AC/DC	34.51.7.060.5010	93.64.0.125
39.41.8.230.5060	(230...240)V AC	34.51.7.060.5010	93.64.8.230
<b>MasterOUTPUT 1 NO, 6 A only</b>			
39.21.0.006.0060	6 V AC/DC	34.51.7.005.0010	93.62.7.024
39.21.0.012.0060	12 V AC/DC	34.51.7.012.0010	93.62.7.024
39.21.0.024.0060	24 V AC/DC	34.51.7.024.0010	93.62.7.024
39.21.0.125.0060	(110...125)V AC/DC	34.51.7.060.0010	93.62.0.125
39.21.8.230.0060	(230...240)V AC	34.51.7.060.0010	93.62.8.230
<b>MasterTIMER</b>			
39.81.0.012.0060	12 V AC/DC	34.51.7.012.0010	93.68.0.024
39.81.0.024.0060	24 V AC/DC	34.51.7.024.0010	93.68.0.024

## Solid State Relay (1 Pole 0.1, 2 or 6 A) & Screw Socket Combinations

Interface Module Code	Input voltage	Relay	Socket
<b>MasterBASIC</b>			
39.10.7.006.xxxx	6 V DC	34.81.7.005.xxxx	93.61.7.024
39.10.7.012.xxxx	12 V DC	34.81.7.012.xxxx	93.61.7.024
39.10.7.024.xxxx	24 V DC	34.81.7.024.xxxx	93.61.7.024
39.10.0.125.xxxx	(110...125)V AC/DC	34.81.7.060.xxxx	93.61.0.125
39.10.8.230.xxxx	(230...240)V AC	34.81.7.060.xxxx	93.61.8.230
<b>MasterPLUS</b>			
39.30.7.006.xxxx	6 V DC	34.81.7.005.xxxx	93.63.7.024
39.30.7.012.xxxx	12 V DC	34.81.7.012.xxxx	93.63.7.024
39.30.7.024.xxxx	24 V DC	34.81.7.024.xxxx	93.63.7.024
39.30.7.060.xxxx	60 V DC	34.81.7.060.xxxx	93.63.7.060
39.30.7.125.xxxx	(110...125)V DC	34.81.7.060.xxxx	93.63.7.125
39.30.7.220.xxxx	220 V DC	34.81.7.060.xxxx	93.63.7.220
39.30.0.024.xxxx	24 V AC/DC	34.81.7.024.xxxx	93.63.0.024
39.30.0.125.xxxx	(110...125)V AC/DC	34.81.7.060.xxxx	93.63.0.125
39.30.0.240.xxxx	(24...240)V AC/DC	34.81.7.024.xxxx	93.63.0.240
39.30.8.230.xxxx	(230...240)V AC	34.81.7.060.xxxx	93.63.8.230
39.30.3.125.xxxx	(110...125)V AC/DC	34.81.7.060.xxxx	93.63.3.125
39.30.3.230.xxxx	(230...240)V AC	34.81.7.060.xxxx	93.63.3.230
<b>MasterINPUT</b>			
39.40.7.006.xxxx	6 V DC	34.81.7.005.xxxx	93.64.7.024
39.40.7.012.xxxx	12 V DC	34.81.7.012.xxxx	93.64.7.024
39.40.7.024.xxxx	24 V DC	34.81.7.024.xxxx	93.64.7.024
39.40.0.024.xxxx	24 V AC/DC	34.81.7.024.xxxx	93.64.0.024
39.40.0.125.xxxx	(110...125)V AC/DC	34.81.7.060.xxxx	93.64.0.125
39.40.8.230.xxxx	(230...240)V AC	34.81.7.060.xxxx	93.64.8.230
<b>MasterOUTPUT</b>			
39.20.7.006.xxxx	6 V DC	34.81.7.005.xxxx	93.62.7.024
39.20.7.012.xxxx	12 V DC	34.81.7.012.xxxx	93.62.7.024
39.20.7.024.xxxx	24 V DC	34.81.7.024.xxxx	93.62.7.024
39.20.0.125.xxxx	(110...125)V AC/DC	34.81.7.060.xxxx	93.62.0.125
39.20.8.230.xxxx	(230...240)V AC	34.81.7.060.xxxx	93.62.8.230
<b>MasterTIMER</b>			
39.80.0.012.xxxx	12 V AC/DC	34.81.7.012.xxxx	93.68.0.024
39.80.0.024.xxxx	24 V AC/DC	34.81.7.024.xxxx	93.68.0.024

## Electromechanical Relay (1 Pole 6 A) & Push-in Socket Combinations

Interface Module Code	Coil voltage	Relay	Socket
<b>MasterBASIC</b>			
39.01.0.006.0060	6 V AC/DC	34.51.7.005.0010	93.60.7.024
39.01.0.012.0060	12 V AC/DC	34.51.7.012.0010	93.60.7.024
39.01.0.024.0060	24 V AC/DC	34.51.7.024.0010	93.60.7.024
39.01.0.125.0060	(110...125)V AC/DC	34.51.7.060.0010	93.60.0.125
39.01.8.230.0060	(230...240)V AC	34.51.7.060.0010	93.60.8.230
<b>MasterPLUS</b>			
39.61.0.006.0060	6 V AC/DC	34.51.7.005.0010	93.66.7.024
39.61.0.012.0060	12 V AC/DC	34.51.7.012.0010	93.66.7.024
39.61.0.024.0060	24 V AC/DC	34.51.7.024.0010	93.66.7.024
39.61.0.060.0060	60 V AC/DC	34.51.7.060.0010	93.66.7.060
39.61.0.125.0060	(110...125)V AC/DC	34.51.7.060.0010	93.66.0.125
39.61.0.240.0060	(24...240)V AC/DC	34.51.7.024.0010	93.66.0.240
39.61.8.230.0060	(230...240)V AC	34.51.7.060.0010	93.66.8.230
39.61.7.125.0060	(110...125)V DC	34.51.7.060.0010	93.66.7.125
39.61.7.220.0060	220 V DC	34.51.7.060.0010	93.66.7.220
39.61.3.125.0060	(110...125)V AC/DC	34.51.7.060.0010	93.66.3.125
39.61.3.230.0060	(230...240)V AC	34.51.7.060.0010	93.66.3.230
<b>MasterINPUT</b>			
39.71.0.006.5060	6 V AC/DC	34.51.7.005.5010	93.67.7.024
39.71.0.012.5060	12 V AC/DC	34.51.7.012.5010	93.67.7.024
39.71.0.024.5060	24 V AC/DC	34.51.7.024.5010	93.67.7.024
39.71.0.125.5060	(110...125)V AC/DC	34.51.7.060.5010	93.67.0.125
39.71.8.230.5060	(230...240)V AC	34.51.7.060.5010	93.67.8.230
<b>MasterOUTPUT 1 NO, 6 A only</b>			
39.51.0.006.0060	6 V AC/DC	34.51.7.005.0010	93.65.7.024
39.51.0.012.0060	12 V AC/DC	34.51.7.012.0010	93.65.7.024
39.51.0.024.0060	24 V AC/DC	34.51.7.024.0010	93.65.7.024
39.51.0.125.0060	(110...125)V AC/DC	34.51.7.060.0010	93.65.0.125
39.51.8.230.0060	(230...240)V AC	34.51.7.060.0010	93.65.8.230
<b>MasterTIMER</b>			
39.91.0.012.0060	12 V AC/DC	34.51.7.012.0010	93.69.0.024
39.91.0.024.0060	24 V AC/DC	34.51.7.024.0010	93.69.0.024

## Solid State Relay (1 Pole 0.1, 2 or 6 A) & Push-in Socket Combinations

Interface Module Code	Input voltage	Relay	Socket
<b>MasterBASIC</b>			
39.00.7.006.xxxx	6 V DC	34.81.7.005.xxxx	93.60.7.024
39.00.7.012.xxxx	12 V DC	34.81.7.012.xxxx	93.60.7.024
39.00.7.024.xxxx	24 V DC	34.81.7.024.xxxx	93.60.7.024
39.00.0.125.xxxx	(110...125)V AC/DC	34.81.7.060.xxxx	93.60.0.125
39.00.8.230.xxxx	(230...240)V AC	34.81.7.060.xxxx	93.60.8.230
<b>MasterPLUS</b>			
39.60.7.006.xxxx	6 V DC	34.81.7.005.xxxx	93.66.7.024
39.60.7.012.xxxx	12 V DC	34.81.7.012.xxxx	93.66.7.024
39.60.7.024.xxxx	24 V DC	34.81.7.024.xxxx	93.66.7.024
39.60.7.060.xxxx	60 V DC	34.81.7.060.xxxx	93.66.7.060
39.60.7.125.xxxx	(110...125)V DC	34.81.7.060.xxxx	93.66.7.125
39.60.7.220.xxxx	220 V DC	34.81.7.060.xxxx	93.66.7.220
39.60.0.024.xxxx	24 V AC/DC	34.81.7.024.xxxx	93.66.0.024
39.60.0.125.xxxx	(110...125)V AC/DC	34.81.7.060.xxxx	93.66.0.125
39.60.0.240.xxxx	(24...240)V AC/DC	34.81.7.024.xxxx	93.66.0.240
39.60.8.230.xxxx	(230...240)V AC	34.81.7.060.xxxx	93.66.8.230
39.60.3.125.xxxx	(110...125)V AC/DC	34.81.7.060.xxxx	93.66.3.125
39.60.3.230.xxxx	(230...240)V AC	34.81.7.060.xxxx	93.66.3.230
<b>MasterINPUT</b>			
39.70.7.006.xxxx	6 V DC	34.81.7.005.xxxx	93.67.7.024
39.70.7.012.xxxx	12 V DC	34.81.7.012.xxxx	93.67.7.024
39.70.7.024.xxxx	24 V DC	34.81.7.024.xxxx	93.67.7.024
39.70.0.024.xxxx	24 V AC/DC	34.81.7.024.xxxx	93.67.0.024
39.70.0.125.xxxx	(110...125)V AC/DC	34.81.7.060.xxxx	93.67.0.125
39.70.8.230.xxxx	(230...240)V AC	34.81.7.060.xxxx	93.67.8.230
<b>MasterOUTPUT</b>			
39.50.7.006.xxxx	6 V DC	34.81.7.005.xxxx	93.65.7.024
39.50.7.012.xxxx	12 V DC	34.81.7.012.xxxx	93.65.7.024
39.50.7.024.xxxx	24 V DC	34.81.7.024.xxxx	93.65.7.024
39.50.0.125.xxxx	(110...125)V AC/DC	34.81.7.060.xxxx	93.65.0.125
39.50.8.230.xxxx	(230...240)V AC	34.81.7.060.xxxx	93.65.8.230
<b>MasterTIMER</b>			
39.90.0.012.xxxx	12 V AC/DC	34.81.7.012.xxxx	93.69.0.024
39.90.0.024.xxxx	24 V AC/DC	34.81.7.024.xxxx	93.69.0.024

Example: .xxxx  
.9024  
.7048  
.8240

### MasterBASIC ATEX/HazLoc - EMR version, Screw Socket Combinations

Interface Module Code	Coil voltage	Relay	Socket
<i>MasterBASIC ATEX</i>			
39.11.0.006.0073	6 V AC/DC	34.51.7.005.0000	93.61.0.024.7
39.11.0.012.0073	12 V AC/DC	34.51.7.012.0000	93.61.0.024.7
39.11.0.024.0073	24 V AC/DC	34.51.7.024.0000	93.61.0.024.7
39.11.0.125.0073	(110...125)V AC/DC	34.51.7.060.0000	93.61.0.125.7
39.11.0.240.0073	(24...240)V AC/DC	34.51.7.024.0000	93.61.0.240.7
39.11.8.230.0073	(230...240)V AC	34.51.7.060.0000	93.61.8.230.7

### MasterBASIC ATEX/HazLoc - EMR version, Push-in Socket Combinations

Interface Module Code	Input voltage	Relay	Socket
<i>MasterBASIC ATEX</i>			
39.01.0.006.0073	6 V AC/DC	34.51.7.005.0000	93.60.0.024.7
39.01.0.012.0073	12 V AC/DC	34.51.7.012.0000	93.60.0.024.7
39.01.0.024.0073	24 V AC/DC	34.51.7.024.0000	93.60.0.024.7
39.01.0.125.0073	(110...125)V AC/DC	34.51.7.060.0000	93.60.0.125.7
39.01.0.240.0073	(24...240)V AC/DC	34.51.7.024.0000	93.60.0.240.7
39.01.8.230.0073	(230...240)V AC	34.51.7.060.0000	93.60.8.230.7

### MasterTIMER ATEX/HazLoc - EMR version, Screw Socket Combinations

Interface Module Code	Input voltage	Relay	Socket
<i>MasterTIMER ATEX</i>			
39.81.0.012.0073	12 V AC/DC	34.51.7.012.0000	93.68.0.024.7
39.81.0.024.0073	24 V AC/DC	34.51.7.024.0000	93.68.0.024.7

### MasterTIMER ATEX/HazLoc - EMR version, Push-in Socket Combinations

Interface Module Code	Input voltage	Relay	Socket
<i>MasterTIMER ATEX</i>			
39.91.0.012.0073	12 V AC/DC	34.51.7.012.0000	93.69.0.024.7
39.91.0.024.0073	24 V AC/DC	34.51.7.024.0000	93.69.0.024.7

### MasterBASIC HazLoc - SSR version, Screw Socket Combinations

Interface Module Code	Input voltage	Relay	Socket
<i>MasterBASIC HazLoc</i>			
39.10.0.006.yy73	6 V AC/DC	34.81.7.005.xxxx	93.61.0.024.7
39.10.0.012.yy73	12 V AC/DC	34.81.7.012.xxxx	93.61.0.024.7
39.10.0.024.yy73	24 V AC/DC	34.81.7.024.xxxx	93.61.0.024.7
39.10.0.125.yy73	(110...125)V AC/DC	34.81.7.060.xxxx	93.61.0.125.7
39.10.0.240.yy73	(24...240)V AC/DC	34.81.7.024.xxxx	93.61.0.240.7
39.10.8.230.yy73	(230...240)V AC	34.81.7.060.xxxx	93.61.8.230.7

### MasterBASIC HazLoc - SSR version, Push-in Socket Combinations

Interface Module Code	Input voltage	Relay	Socket
<i>MasterBASIC HazLoc</i>			
39.00.0.006.yy73	6 V AC/DC	34.81.7.005.xxxx	93.60.0.024.7
39.00.0.012.yy73	12 V AC/DC	34.81.7.012.xxxx	93.60.0.024.7
39.00.0.024.yy73	24 V AC/DC	34.81.7.024.xxxx	93.60.0.024.7
39.00.0.125.yy73	(110...125)V AC/DC	34.81.7.060.xxxx	93.60.0.125.7
39.00.0.240.yy73	(24...240)V AC/DC	34.81.7.024.xxxx	93.60.0.240.7
39.00.8.230.yy73	(230...240)V AC	34.81.7.060.xxxx	93.60.8.230.7

### MasterTIMER HazLoc - SSR version, Screw Socket Combinations

Interface Module Code	Input voltage	Relay	Socket
<i>MasterTIMER HazLoc</i>			
39.80.0.012.8273	12 V AC/DC	34.81.7.012.8240	93.68.0.024.7
39.80.0.024.8273	24 V AC/DC	34.81.7.024.8240	93.68.0.024.7
39.80.0.012.9073	12 V AC/DC	34.81.7.012.9024	93.68.0.024.7
39.80.0.024.9073	24V AC/DC	34.81.7.024.9024	93.68.0.024.7

### MasterTIMER HazLoc - SSR version, Push-in Socket Combinations

Interface Module Code	Input voltage	Relay	Socket
<i>MasterTIMER HazLoc</i>			
39.90.0.012.8273	12 V AC/DC	34.81.7.012.8240	93.69.0.024.7
39.90.0.024.8273	24 V AC/DC	34.81.7.024.8240	93.69.0.024.7
39.90.0.012.9073	12 V AC/DC	34.81.7.012.9024	93.69.0.024.7
39.90.0.024.9073	24 V AC/DC	34.81.7.024.9024	93.69.0.024.7

Example:

- .yy
- .9073 (5A - 24 V DC)
- .8273 (0.75 A - 230 V AC)
- .xxxx
- .9024
- .8240



Accessories

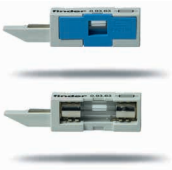

**093.63**  
Approvals  
(according to type):



**093.63.0.024**  
**093.63.8.230**

<b>Output fuse module for 39.31/30/81/80/61/60/91/90 types</b>	093.63	093.63.0.024	093.63.8.230
--	--------	--------------	--------------

- For 5 x 20 mm fuses up to 6 A, 250 V
- Type 093.63 - Easy visibility of the fuse condition through the window
- Type 093.63.0.024 - (6...24)V AC/DC with LED fuse status indicator
- Type 093.63.8.230 - (110...240)V AC with LED fuse status indicator
- Quick connection to socket

**Notes**

**Safety:** Because the output circuit can be reinstated (point 3 below), even with the fuse removed, it is important not to consider the removal of the fuse as a "safety disconnect". Always isolate elsewhere before working on the circuit.

**UL:** According to UL508A, the fuse module cannot be installed in power circuits (in which it is mandatory that a fuse certified according to UL category JDDZ be fitted). However, where the MasterInterface is connected as an output interface to a PLC no such restrictions apply, and the fuse module can be usefully employed.

**Type 093.63**

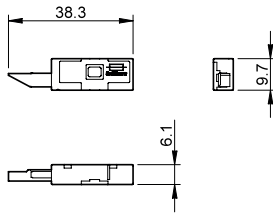

**Type 093.63.0.24 / 093.63.8.230**

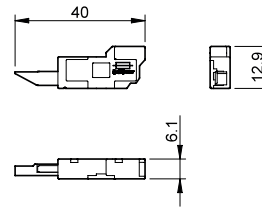

**Multi-state fuse module**

**0.** As delivered, the socket comes without a fuse module. However, a "bridging" module guarantee the output electrical connections.

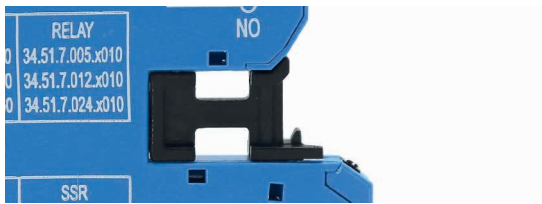

**1.** In order to use a fuse module, it is enough to remove the "bridging" module and replace it by the fuse module. The fuse is positioned electrically in series with the common output terminal of the interface module (11 for EMR versions, 13+ for SSR versions, 15 for EMR timer, 15+ for SSR timer) . .

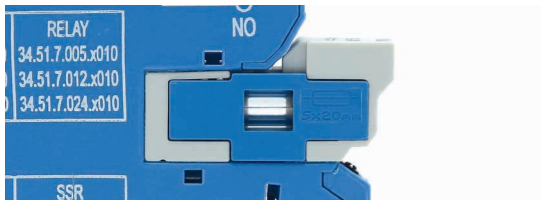

**2.** If the fuse module is extracted (for example; because the fuse element has blown) the output circuit will be locked open, as this will generally be the "safe option".



**3.** In order to reinstate the output circuit it is necessary to either re-insert the fuse module (complete with functional fuse), or, alternatively, the "bridging" module.

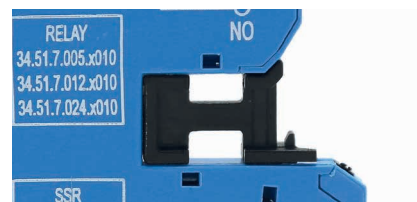
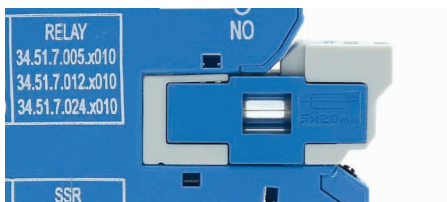



Accessories



093.16



093.16.0



093.16.1

Approvals  
(according to type):



<b>16-way jumper link</b>	093.16 (blue)	093.16.0 (black)	093.16.1 (red)
Rated values	36 A* - 250 V		

Possibility of multiple connection, side by side

\* Maximum rating of the jumper link. Each individual pole shall not exceed the 6 A limit of the interface to which it is connected.

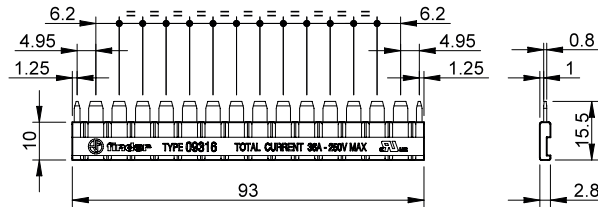

093.60

<b>Dual-purpose plastic separator (1.8 mm or 6.2 mm separation)</b>	093.60
---	--------

1. By breaking off the protruding ribs (by hand), the separator becomes only 1.8 mm thick; useful for the visual separation of different groups of interfaces, or necessary for the protective separation of different voltages of neighbouring interfaces, or for the protection of cut ends of jumper links.

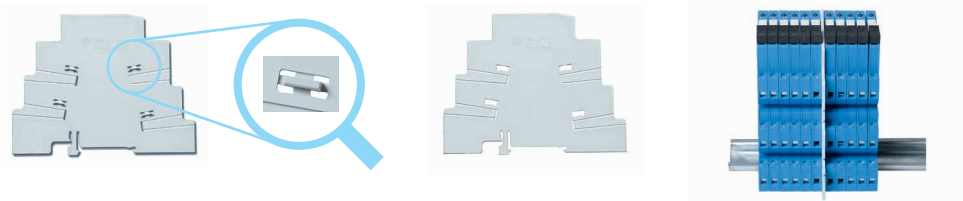

2. Leaving the ribs in place provides 6.2 mm separation. Simply cutting (with scissors) the relevant segment(s) permits the interconnection across the separator of 2 different groups of interface relays, using the standard jumper link.

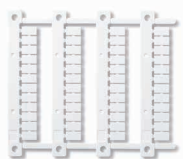
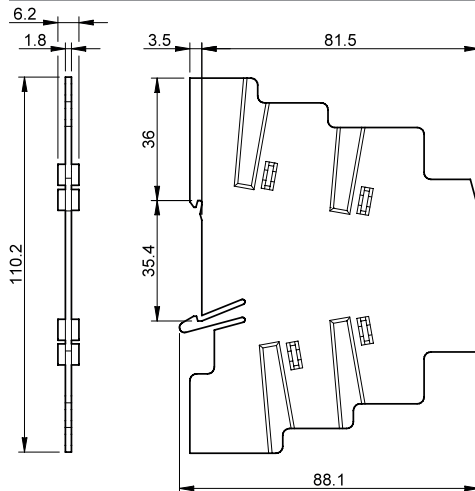

093.48

<b>Sheet of marker tags, plastic, 48 tags, 6 x 10 mm</b>	093.48
--	--------

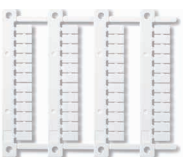

060.48

<b>Sheet of marker tags (CEMBRE Thermal transfer printers), 48 tags, 6 x 12 mm</b>	060.48
--	--------

Accessories



<b>Terminal doubler</b> (for Push-in sockets only)	093.62
Total load	6 A - 300 V
Max. wire size	<b>Solid and stranded cable</b>
	mm <sup>2</sup> 2 x 1.5 AWG 2 x 16

B



093.68.14.1

Approvals  
(according to type):



<b>MasterADAPTER</b>	093.68.14.1
The <b>MasterADAPTER</b> permits the easy connection of A1/A2 terminals of up to 8 <b>MasterINTERFACE</b> modules to PLC outputs via a 14-Pole ribbon cable, plus simple 2-wire power supply connection ATEX Version.	

<b>Technical data</b>	
Rated current (per signal path)	A 1
Minimum required supply power	W 3
Nominal voltage (U <sub>N</sub> )	V DC 24
Operating range	(0.8...1.1)U <sub>N</sub>
Control logic	Positive switching (to A1)
Power supply status indication	Green LED
Ambient temperature range	°C -40...+70

<b>Terminals for 24 V control logic</b>	
Type of connector	14 pole, according to IEC 60603-13
ATEX version	II 3G Ex nA IIC Gc

<b>Terminals for 24 V power supply</b>	
Wire strip length	mm 9.5
Screw torque	Nm 0.5
Max. wire size	solid wire
	mm <sup>2</sup> 1 x 4 / 2 x 1.5 AWG 1 x 12 / 2 x 16
	stranded wire
	mm <sup>2</sup> 1 x 2.5 / 2 x 1.5 AWG 1 x 14 / 2 x 16

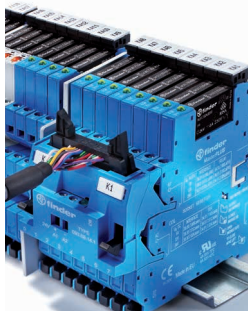

Connected **MasterADAPTER**

Wiring diagram

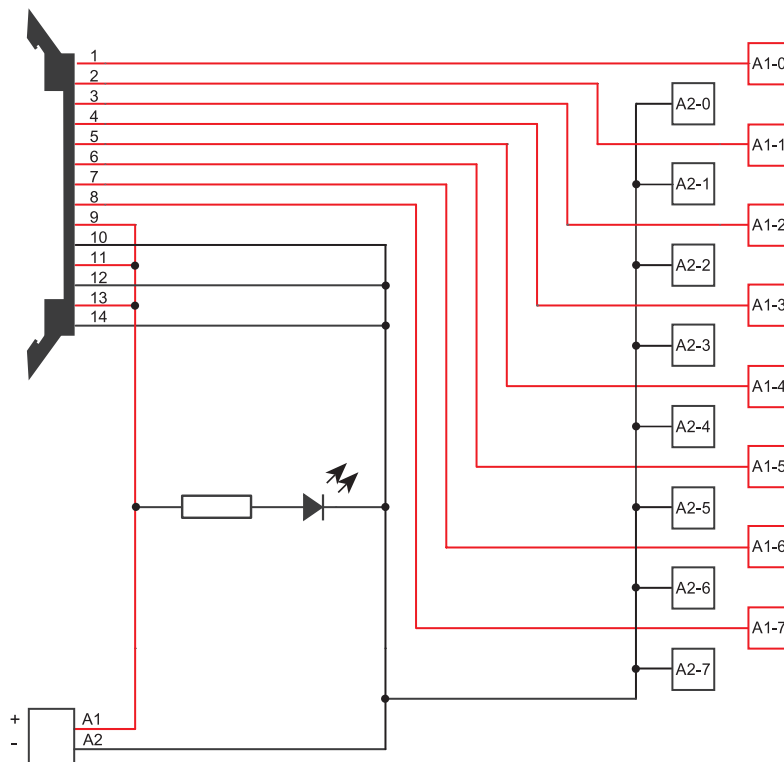

Accessories



<b>PLC cable</b>	093.00020	
Lenght	mt	2
Operating voltage	V	35
Nominal current per wire	A	0.7
N° of poles		14
Ambient temperature range	°C	-40...+50
Wire size	mm <sup>2</sup>	0.2
	AWG	24

B

Color code according to DIN VDE 47100		
		Number connector 14 poles
White		1
Brown		2
Green		3
Yellow		4
Grey		5
Pink		6
Blue		7
Red		8
Black		9
Violet		10
Grey/Pink		11
Blue/Red		12
White/Green		13
Brown/Green		14

Useful length: L +/- 1%

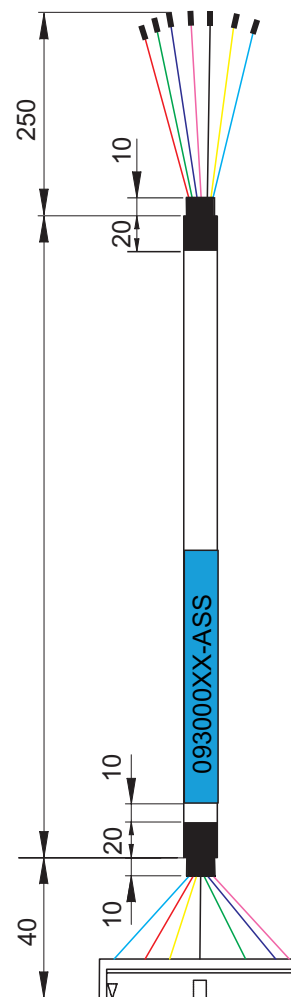



# Relay Interface Modules 8 - 10 - 16 A



Control panels



Carousel  
warehouses



Medical and  
dentistry



Shipyards



Elevators  
and lifts



Panels for electrical  
distribution



Building  
automation



Hoists and cranes

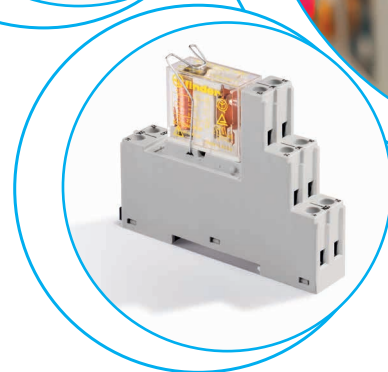
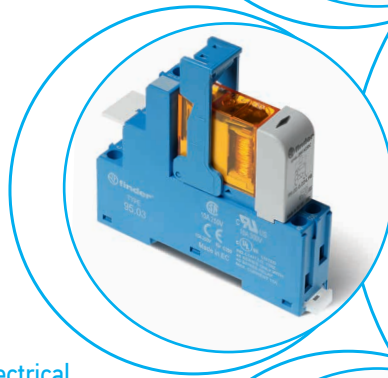
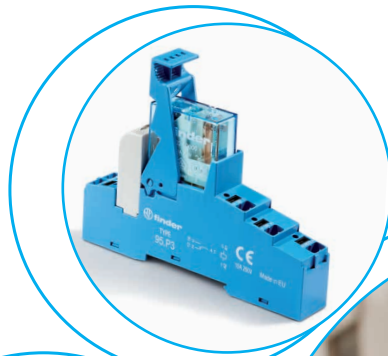



2 CO relay interface modules,  
15.8 mm wide

**Type 48.12 and 48.P2**

**Ideal for safety applications**

- 2 CO 8 A
- Relay with forcibly guided contacts according to EN 61810-3 Type B (previously EN 50205)

**Type 48.32**

**Ideal for energy applications**

- 2 CO 8 A
- Breaking capacity DC inductive (L/R=40 ms)
  - 110 V = 0.5 A
  - 220 V = 0.2 A
- Screw terminals

- DC coils
- Identification label
- UL Listing (certain relay / socket combinations)
- 35 mm rail (EN 60715) mounting
- Cadmium-free contact material

48.12/32

Screw terminal



48.P2

Push-in terminal



According to EN 61810-3 only 1 NO and 1 NC (11-14 and 21-22 or 11-12 and 21-24) shall be used as forcibly guided contacts (Type 48.12/P2).

For outline drawing see page 11

**Contact specification**

Contact configuration		2 CO (DPDT)	2 CO (DPDT)
Rated current/Maximum peak current	A	8/15	8/15
Rated voltage/ Maximum switching voltage	V AC	250/400	250/400
Rated load AC1	VA	2000	2000
Rated load AC15 (230 V AC)	VA	500	500
Single phase motor rating (230 V AC)	kW	0.37	0.37
Breaking capacity DC1: 24/110/220 V	A	8/0.65/0.4	8/0.65/0.4
Minimum switching load	mW (V/mA)	50 (5/5)	50 (5/5)
Standard contact material		AgNi+Au	AgNi+Au

**Coil specification**

Nominal voltage (U <sub>N</sub> )	V DC	12 - 24	24
Rated power DC	W	0.7	0.7
Operating range	DC	(0.75...1.2)U <sub>N</sub>	(0.75...1.2)U <sub>N</sub>
Holding voltage	DC	0.4 U <sub>N</sub>	0.4 U <sub>N</sub>
Must drop-out voltage	DC	0.1 U <sub>N</sub>	0.1 U <sub>N</sub>

**Technical data**

Mechanical life DC	cycles	10 · 10 <sup>6</sup>	10 · 10 <sup>6</sup>
Electrical life at rated load AC1	cycles	100 · 10 <sup>3</sup>	100 · 10 <sup>3</sup>
Operate/release time	ms	10/4	10/4
Insulation between coil and contacts (1.2/50 μs)	kV	6 (8 mm)	6 (8 mm)
Dielectric strength between open contacts	V AC	1500	1500
Ambient temperature range	°C	-40...+70	-40...+70
Protection category		IP 20	IP 20

**Approvals relay** (according to type)



**NEW 48.12 / 48.P2**

- 2 CO 8 A
- Push-in or screw terminals

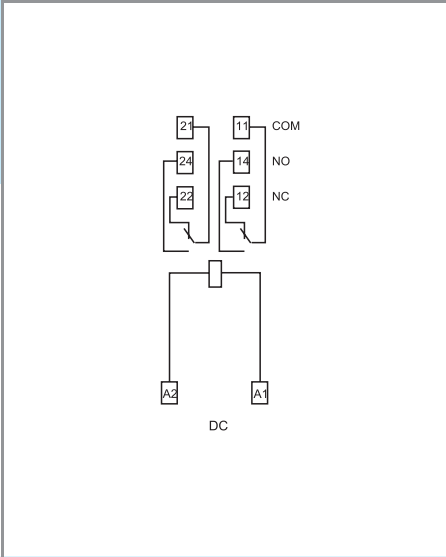

**NEW 48.32**

- 2 CO 8 A
- Screw terminals

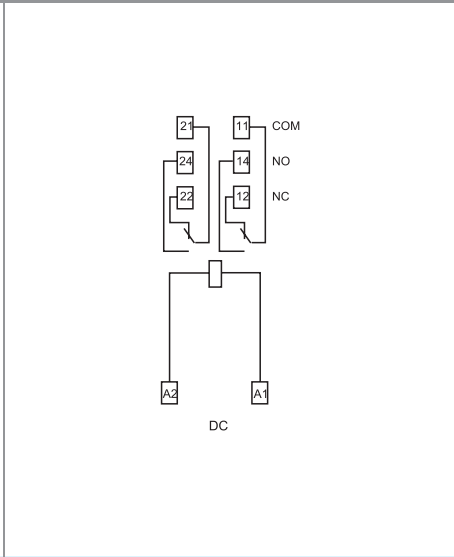

B

**1 CO relay interface modules,  
15.8 mm wide**  
**Ideal interface for PLC and electronic systems**

**Type 48.P3**  
- 1 CO 10 A  
- Push-in terminals

**Type 48.31**  
- 1 CO 10 A  
- Screw terminals

- AC coils or DC sensitive coils
- Supply status indication and EMC coil suppression module as standard
- Identification label
- UL Listing (certain relay/socket combinations)
- 35 mm rail (EN 60715) mounting
- Cadmium-free contact material

48.P3  
Push-in terminal

48.31  
Screw terminal



**48.P3**

- 1 CO 10 A
- Push-in terminals

**48.31**

- 1 CO 10 A
- Screw terminals

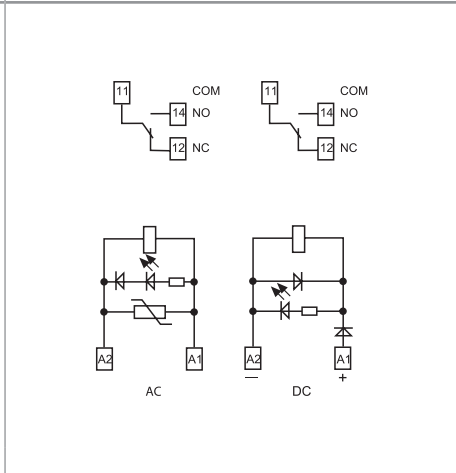
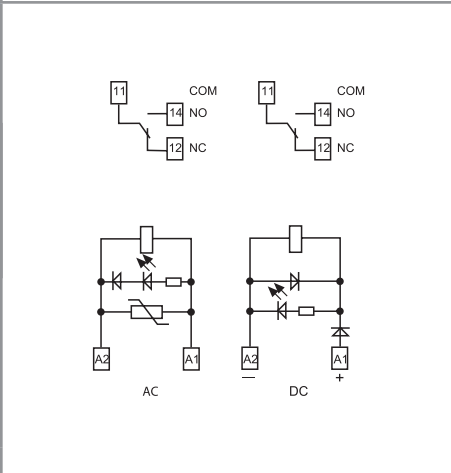

For outline drawing see page 11

**Contact specification**

Contact configuration		1 CO (SPDT)	1 CO (SPDT)
Rated current/Maximum peak current	A	10/20	10/20
Rated voltage/ Maximum switching voltage	V AC	250/400	250/400
Rated load AC1	VA	2500	2500
Rated load AC15 (230 V AC)	VA	500	500
Single phase motor rating (230 V AC)	kW	0.37	0.37
Breaking capacity DC1: 24/110/220 V	A	10/0.3/0.12	10/0.3/0.12
Minimum switching load	mW (V/mA)	300 (5/5)	300 (5/5)
Standard contact material		AgNi	AgNi

**Coil specification**

Nominal voltage (U <sub>N</sub> )	V AC (50/60 Hz)	12 - 24 - 110 - 120 - 230	12 - 24 - 110 - 120 - 230
	V DC	12 - 24 - 125	12 - 24 - 125
Rated power AC/sens. DC	VA (50 Hz)/W	1.2/0.5	1.2/0.5
Operating range	AC	(0.8...1.1)U <sub>N</sub>	(0.8...1.1)U <sub>N</sub>
	sens. DC	(0.73...1.5)U <sub>N</sub>	(0.73...1.5)U <sub>N</sub>
Holding voltage	AC/DC	0.8 U <sub>N</sub> / 0.4 U <sub>N</sub>	0.8 U <sub>N</sub> / 0.4 U <sub>N</sub>
Must drop-out voltage	AC/DC	0.2 U <sub>N</sub> / 0.1 U <sub>N</sub>	0.2 U <sub>N</sub> / 0.1 U <sub>N</sub>

**Technical data**

Mechanical life	cycles	10 · 10 <sup>6</sup>	10 · 10 <sup>6</sup>
Electrical life at rated load AC1	cycles	200 · 10 <sup>3</sup>	200 · 10 <sup>3</sup>
Operate/release time	ms	7/4 (AC) - 12/12 (DC)	7/4 (AC) - 12/12 (DC)
Insulation between coil and contacts (1.2/50 μs)	kV	6 (8 mm)	6 (8 mm)
Dielectric strength between open contacts	V AC	1000	1000
Ambient temperature range	°C	-40...+70	-40...+70
Protection category		IP 20	IP 20

**Approvals relay** (according to type)





**2 CO relay interface modules,  
15.8 mm wide**  
**Ideal interface for PLC and electronic systems**

**Type 48.P5**

- 2 CO 8 A
- Push-in terminals

**Type 48.52**

- 2 CO 8 A
- Screw terminals

- AC coils or DC sensitive coils
- Supply status indication and EMC coil suppression module as standard
- Identification label
- UL Listing (certain relay/socket combinations)
- 35 mm rail (EN 60715) mounting
- Cadmium-free contact material

48.P5  
Push-in terminal



48.52  
Screw terminal



For outline drawing see page 11

**Contact specification**

Contact configuration		2 CO (DPDT)	2 CO (DPDT)
Rated current/Maximum peak current	A	8/15	8/15
Rated voltage/ Maximum switching voltage	V AC	250/400	250/400
Rated load AC1	VA	2000	2000
Rated load AC15 (230 V AC)	VA	400	400
Single phase motor rating (230 V AC)	kW	0.3	0.3
Breaking capacity DC1: 24/110/220 V	A	8/0.3/0.12	8/0.3/0.12
Minimum switching load	mW (V/mA)	300 (5/5)	300 (5/5)
Standard contact material		AgNi	AgNi

**Coil specification**

Nominal voltage (U <sub>N</sub> )	V AC (50/60 Hz)	12 - 24 - 110 - 120 - 230	12 - 24 - 110 - 120 - 230
	V DC	12 - 24 - 125	12 - 24 - 125
Rated power AC/sens. DC	VA (50 Hz)/W	1.2/0.5	1.2/0.5
Operating range	AC	(0.8...1.1)U <sub>N</sub>	(0.8...1.1)U <sub>N</sub>
	sens. DC	(0.73...1.5)U <sub>N</sub>	(0.73...1.5)U <sub>N</sub>
Holding voltage	AC/DC	0.8 U <sub>N</sub> / 0.4 U <sub>N</sub>	0.8 U <sub>N</sub> / 0.4 U <sub>N</sub>
Must drop-out voltage	AC/DC	0.2 U <sub>N</sub> / 0.1 U <sub>N</sub>	0.2 U <sub>N</sub> / 0.1 U <sub>N</sub>

**Technical data**

Mechanical life	cycles	10 · 10 <sup>6</sup>	10 · 10 <sup>6</sup>
Electrical life at rated load AC1	cycles	100 · 10 <sup>3</sup>	100 · 10 <sup>3</sup>
Operate/release time	ms	7/4 (AC) - 12/12 (DC)	7/4 (AC) - 12/12 (DC)
Insulation between coil and contacts (1.2/50 μs)	kV	6 (8 mm)	6 (8 mm)
Dielectric strength between open contacts	V AC	1000	1000
Ambient temperature range	°C	-40...+70	-40...+70
Protection category		IP 20	IP 20

**Approvals relay** (according to type)



**48.P5**



- 2 CO 8 A
- Push-in terminals

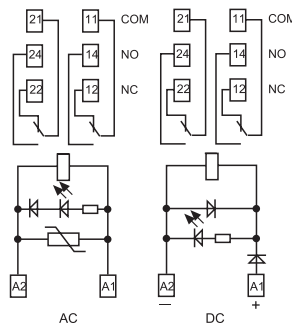

**48.52**

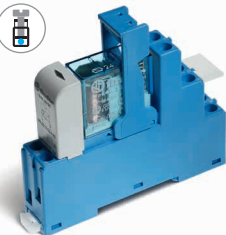

- 2 CO 8 A
- Screw terminals

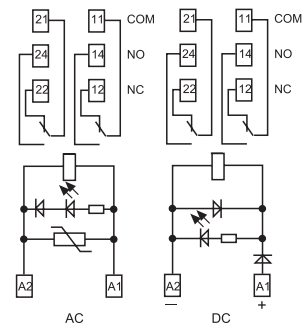

B

1 CO relay interface modules,  
15.8 mm wide

Ideal interface for PLC and electronic systems

**Type 48.P6**

- 1 CO 16 A
- Push-in terminals

**Type 48.61**

- 1 CO 16 A
- Screw terminals

- AC coils or DC sensitive coils
- Supply status indication and EMC coil suppression module as standard
- Identification label
- UL Listing (certain relay/socket combinations)
- 35 mm rail (EN 60715) mounting
- Cadmium-free contact material available

48.P6  
Push-in terminal



48.61  
Screw terminal



For outline drawing see page 11

**Contact specification**

Contact configuration		1 CO (SPDT)	1 CO (SPDT)
Rated current/Maximum peak current	A	16*/30	16*/30
Rated voltage/ Maximum switching voltage	V AC	250/400	250/400
Rated load AC1	VA	4000	4000
Rated load AC15 (230 V AC)	VA	750	750
Single phase motor rating (230 V AC)	kW	0.55	0.55
Breaking capacity DC1: 24/110/220 V	A	16/0.3/0.12	16/0.3/0.12
Minimum switching load	mW (V/mA)	500 (10/5)	500 (10/5)
Standard contact material		AgCdO	AgCdO

**Coil specification**

Nominal voltage (U <sub>N</sub> )	V AC (50/60 Hz)	12 - 24 - 110 - 120 - 230	12 - 24 - 110 - 120 - 230
	V DC	12 - 24 - 125	12 - 24 - 125
Rated power AC/sens. DC	VA (50 Hz)/W	1.2/0.5	1.2/0.5
Operating range	AC	(0.8...1.1)U <sub>N</sub>	(0.8...1.1)U <sub>N</sub>
	sens. DC	(0.8...1.5)U <sub>N</sub>	(0.8...1.5)U <sub>N</sub>
Holding voltage	AC/DC	0.8 U <sub>N</sub> / 0.4 U <sub>N</sub>	0.8 U <sub>N</sub> / 0.4 U <sub>N</sub>
Must drop-out voltage	AC/DC	0.2 U <sub>N</sub> / 0.1 U <sub>N</sub>	0.2 U <sub>N</sub> / 0.1 U <sub>N</sub>

**Technical data**

Mechanical life	cycles	10 · 10 <sup>6</sup>	10 · 10 <sup>6</sup>
Electrical life at rated load AC1	cycles	100 · 10 <sup>3</sup>	100 · 10 <sup>3</sup>
Operate/release time	ms	7/4 (AC) - 12/12 (DC)	7/4 (AC) - 12/12 (DC)
Insulation between coil and contacts (1.2/50 μs)	kV	6 (8 mm)	6 (8 mm)
Dielectric strength between open contacts	V AC	1000	1000
Ambient temperature range	°C	-40...+70	-40...+70
Protection category		IP 20	IP 20

**Approvals relay** (according to type)



**48.P6**



- 1 CO 16 A
- Push-in terminals

**48.61**



- 1 CO 16 A
- Screw terminals

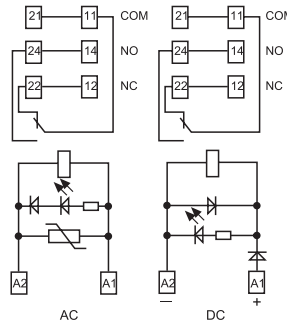

\* For currents > 10 A, contact terminals must be connected in parallel (21 with 11, 24 with 14, 22 with 12).

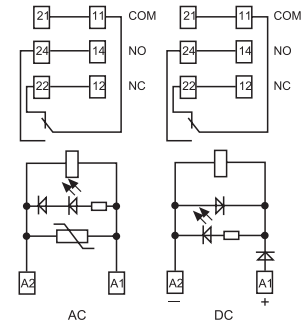

\* For currents > 10 A, contact terminals must be connected in parallel (21 with 11, 24 with 14, 22 with 12).

**2 CO relay interface modules,  
15.8 mm wide**  
**Ideal interface for PLC and electronic systems**

**Type 48.P8**

- 2 CO 10 A
- Push-in terminals

**Type 48.62**

- 2 CO 10 A
- Screw terminals

- DC sensitive coils
- Supply status indication and EMC coil suppression module as standard
- Identification label
- UL Listing (certain relay/socket combinations)
- 35 mm rail (EN 60715) mounting
- Cadmium-free contact material

48.P8  
Push-in terminal



48.62  
Screw terminal



**48.P8**



- 2 CO 10 A
- Push-in terminals

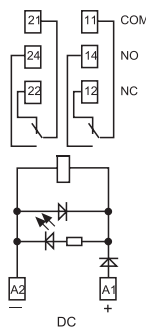

**48.62**

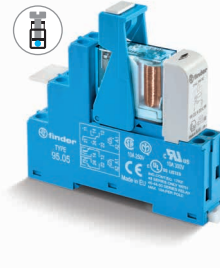

- 2 CO 10 A
- Screw terminals

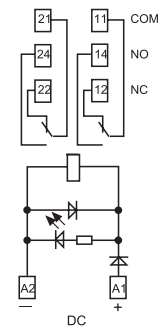

For outline drawing see page 11

**Contact specification**

Contact configuration		2 CO (DPDT)	2 CO (DPDT)
Rated current/Maximum peak current	A	10/20	10/20
Rated voltage/ Maximum switching voltage	V AC	250/400	250/400
Rated load AC1	VA	2500	2500
Rated load AC15 (230 V AC)	VA	750	750
Single phase motor rating (230 V AC)	kW	0.37	0.37
Breaking capacity DC1: 24/110/220 V	A	10/0.6/0.25	10/0.6/0.25
Minimum switching load	mW (V/mA)	300 (5/5)	300 (5/5)
Standard contact material		AgNi	AgNi

**Coil specification**

Nominal voltage (U <sub>N</sub> )	V AC (50/60 Hz)	—	—
	V DC	12 - 24 - 125	12 - 24 - 125
Rated power AC/sens. DC	VA (50 Hz)/W	—/0.5	—/0.5
Operating range	AC	—	—
	sens. DC	(0.8...1.5)U <sub>N</sub>	(0.8...1.5)U <sub>N</sub>
Holding voltage	AC/DC	—/0.4 U <sub>N</sub>	—/0.4 U <sub>N</sub>
Must drop-out voltage	AC/DC	—/0.1 U <sub>N</sub>	—/0.1 U <sub>N</sub>

**Technical data**

Mechanical life	cycles	10 · 10 <sup>6</sup>	10 · 10 <sup>6</sup>
Electrical life at rated load AC1	cycles	100 · 10 <sup>3</sup>	100 · 10 <sup>3</sup>
Operate/release time	ms	12/12 (DC)	12/12 (DC)
Insulation between coil and contacts (1.2/50 μs)	kV	6 (8 mm)	6 (8 mm)
Dielectric strength between open contacts	V AC	1000	1000
Ambient temperature range	°C	-40...+70	-40...+70
Protection category		IP 20	IP 20

**Approvals relay** (according to type)



## Ordering information

Example: 48 series, 35 mm rail (EN 60715) mount, Push-in terminal relay interface module, 2 CO 8 A contacts, 24 V sensitive DC coil, green LED + diode, 99.02 coil indication.

B

**4 8 . P 5 . 7 . 0 2 4 . 0 0 5 0**

### Series

### Type

Screw terminal

- 1 = 35 mm rail (EN 60715) mount, forcibly guided contacts relay
- 3 = 35 mm rail (EN 60715) mount
- 5 = 35 mm rail (EN 60715) mount
- 6 = 35 mm rail (EN 60715) mount
- Push-in terminal
- P = 35 mm rail (EN 60715) mount

### Type

Screw terminal

- 1 = for 48.31, 1 pole, 10 A  
48.61, 1 pole, 16 A
- 2 = for 48.12/48.32 (DC only), 48.52, 2 poles, 8 A  
48.62 (DC only), 2 poles, 10 A

Push-in terminal

- 2 = for 48.P2 (DC only), 2 pole, 8 A
- 3 = for 48.P3, 1 pole, 10 A
- 5 = for 48.P5, 2 pole, 8 A
- 6 = for 48.P6, 1 pole, 16 A
- 8 = for 48.P8 (DC only), 2 pole, 10 A

### Coil version

- 7 = Sensitive DC
- 8 = AC (50/60 Hz)
- 9 = DC (for 48.12/48.32/48.P2 only)

### Coil voltage

See coil specifications

### A: Contact material

- 0 = Standard AgNi for 48.P3/P5/P8/31/52/62 AgCdO, Standard for 48.P6/61
- 4 = AgSnO<sub>2</sub>, for 48.P6/P8/61/62 only
- 5 = AgNi + Au, for 48.12/P2 and 48.P3/P5/31/52 only Standard for 48.32

### B: Contact circuit

- 0 = CO (nPDT)

### D: Special versions

- 0 = Standard
- 7 = Standard (for 48.12/48.P2 only)

### C: Options

- 0 = Standard (for 48.12/48.P2 only)
- 5 = Standard for DC: green LED + diode (polarity +A1)
- 6 = Standard for AC and 48.32: green LED + Varistor

**Selecting features and options: only combinations in the same row are possible.**

Preferred selections for best availability are shown in **bold**.

Type	Coil version	A	B	C	D
48.12/48.P2	DC	<b>5</b>	<b>0</b>	<b>0</b>	<b>7</b>
48.32	DC	<b>5</b>	<b>0</b>	<b>6</b>	<b>0</b>
48.P3/P5/31/52	AC	<b>0 - 5</b>	0	<b>6</b>	0
48.P3/P5/31/52	Sensitive DC	<b>0 - 5</b>	0	<b>5</b>	0
48.P6/61	AC	<b>0 - 4</b>	0	<b>6</b>	0
48.P6/61	Sensitive DC	<b>0 - 4</b>	0	<b>5</b>	0
48.P8/62	Sensitive DC	<b>0 - 4</b>	0	<b>5</b>	0

## Technical data

Insulation		48.12/P2/31/32/61/P3/P6	48.52/P5	48.12/31/61/62/P3/P6/P8
Insulation according to EN 61810-1	insulation rated voltage	V	250	250
	rated impulse withstand voltage	kV	4	4
	pollution degree		3	2
	overvoltage category		III	III
Insulation between coil and contacts (1.2/50 µs)		kV	6 (8 mm)	
Dielectric strength between open contacts		V AC	1000; 1500 (48.12/P2/32)	
Dielectric strength between adjacent contacts		V AC	2000 (48.P5/52); 2500 (48.P8/62) 3000 (48.12/P2/32)	
<b>Insulation between coil terminals</b>				
Rated impulse voltage (surge) differential mode (according to EN 61000-4-5)		kV (1.2/50 µs)	2	
<b>Other data</b>				
Bounce time: NO/NC		ms	2/5; 2/10 (48.12/P2/32)	
Vibration resistance (10...200)Hz: NO/NC		g	20/5 (for 1 pole)	15/3; 20/6 (48.12/P2/32) for 2 pole
Power lost to the environment	without contact current	W	0.7	
	with rated current	W	1.2 (48.12/P2/31/32/P3)	2 (48.52/P5/61/62/P6/P8)
Wire strip length		mm	8	
⊕ Screw torque (only for 48.12/31/32/52/61/81)		Nm	0.5	
Min. wire size	<b>Screw terminal</b>		<b>Push-in terminal</b>	
			solid cable	stranded cable
	mm <sup>2</sup>	0.5	0.5	0.5
	AWG	21	21	21
Max. wire size	<b>Screw terminal</b>		<b>Push-in terminal</b>	
			solid cable	stranded cable
	mm <sup>2</sup>	1 x 6 / 2 x 2.5	1 x 4 / 2 x 2.5	2 x 1.5 / 1 x 2.5
	AWG	1 x 10 / 2 x 14	1 x 12 / 2 x 14	2 x 16 / 1 x 14

### Contact specification

**F 48 - Electrical life (AC) v contact current**  
Types 48.P3/P6/31/61

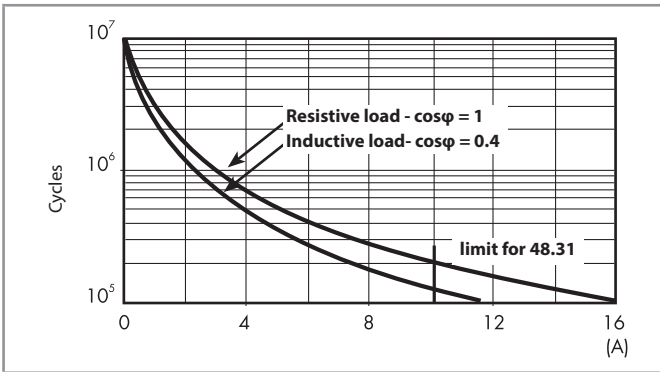

**F 48 - Electrical life (AC) v contact current**  
Types 48.P8/62

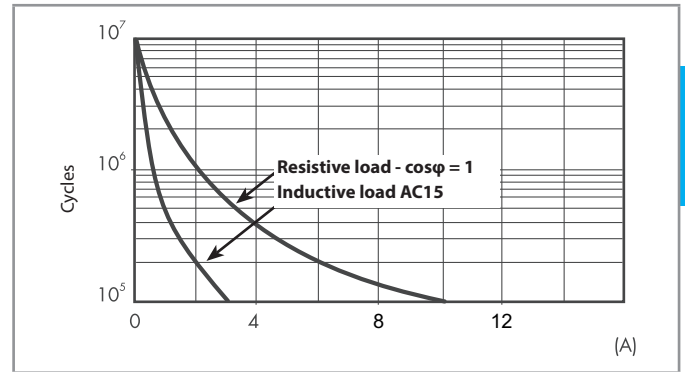

**F 48 - Electrical life (AC) v contact current**  
Types 48.P5/52

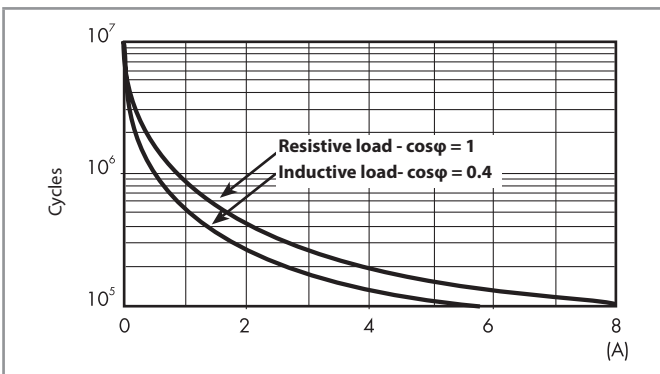

**F 48 - Electrical life (AC) v contact current**  
Type 48.12/P2/32

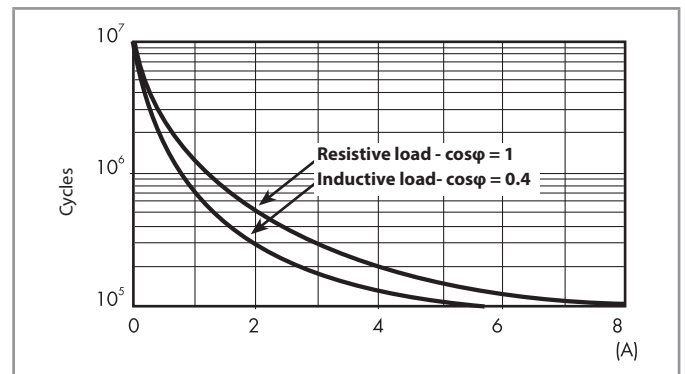

**H 48 - Maximum DC1 breaking capacity**  
Types 48.P3/P5/P6/31/52/61

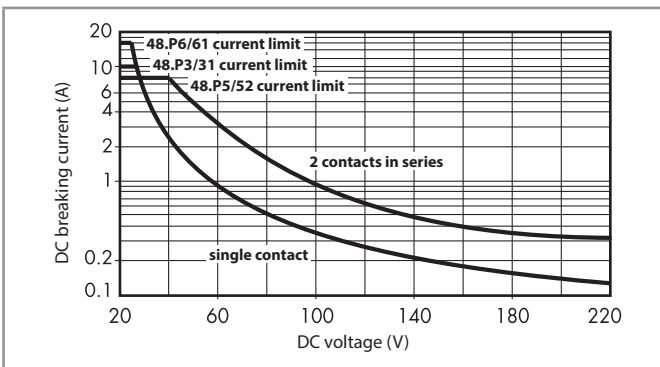

**H 48 - Maximum DC1 breaking capacity**  
Types 48.P8/62

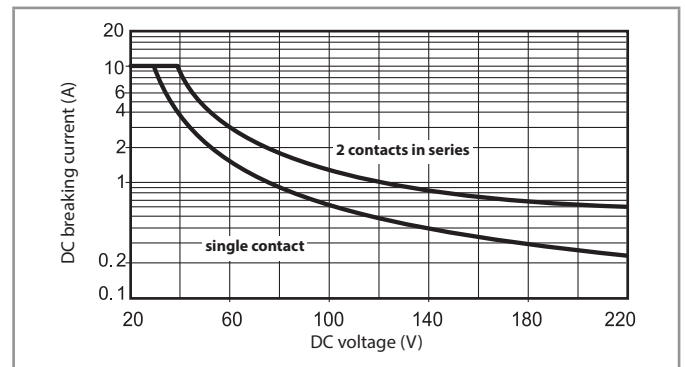

**H 48 - Maximum DC1 breaking capacity**  
Type 48.12/P2/32

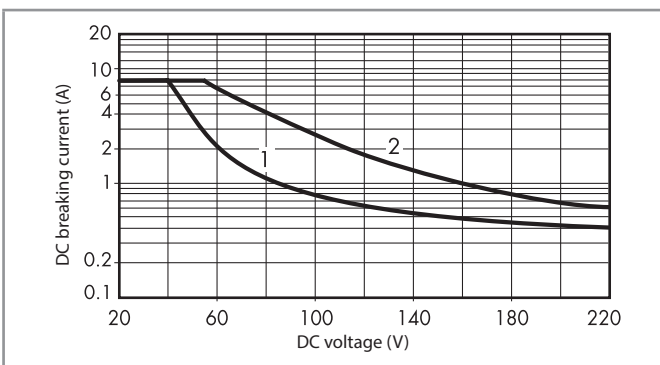

- When switching a resistive load (DC1) having voltage and current values under the curve, an electrical life of  $\geq 100 \cdot 10^3$  can be expected.
  - In the case of DC13 loads, the connection of a diode in parallel with the load will permit a similar electrical life as for a DC1 load.
- Note: the release time for the load will be increased.

## Coil specifications

### DC coil data (0.5 W sensitive)

Nominal voltage $U_N$	Coil code	Operating range		Rated coil consumption I at $U_N$
		$U_{min}^*$	$U_{max}$	
V		V	V	mA
12	7.012	8.8	18	41
24	7.024	17.5	36	22.2
125	7.125	91	188	4

\*  $U_{min} = 0.8 U_N$  for 48.61, 48.62, 48.P6, 48.P8

### AC coil data

Nominal voltage $U_N$	Coil code	Operating range		Rated coil consumption I at $U_N$ (50 Hz)
		$U_{min}$	$U_{max}$	
V		V	V	mA
12	8.012	9.6	13.2	90.5
24	8.024	19.2	26.4	46
110	8.110	88	121	10.1
120	8.120	96	132	11.8
230	8.230	184	253	7.0

### DC coil data, (0.7 W standard) - Type 48.12/48.P2/48.32, (48.32 available only 24 V DC)

Nominal voltage $U_N$	Coil code	Operating range		Resistance R	Rated coil consumption I at $U_N$
		$U_{min}$	$U_{max}$		
V		V	V	$\Omega$	mA
12	9.012	9	14.4	205	58.5
24	9.024	18	28.8	820	29.3

### R 48 - DC coil operating range v ambient temperature

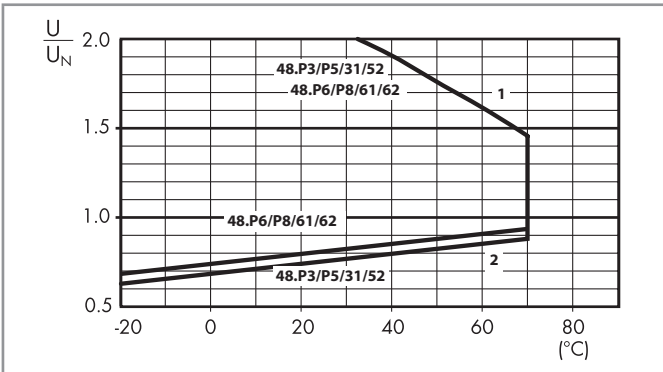

- 1 - Max. permitted coil voltage.
- 2 - Min. pick-up voltage with coil at ambient temperature.

### R 48 - AC coil operating range v ambient temperature

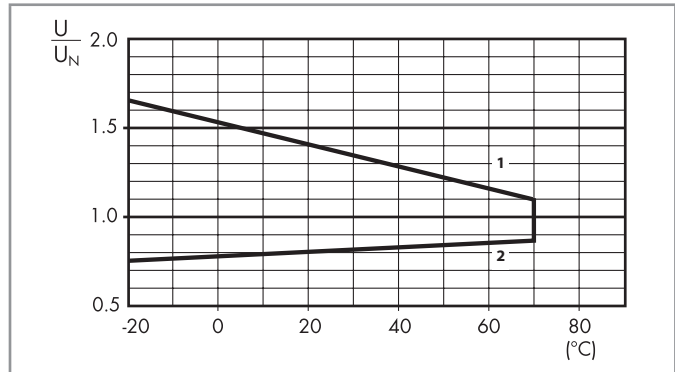

- 1 - Max. permitted coil voltage.
- 2 - Min. pick-up voltage with coil at ambient temperature.

### R 48 - DC coil operating range v ambient temperature Type 48.12/P2/32

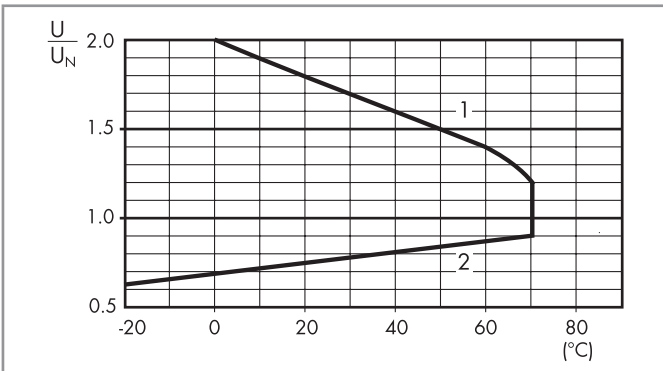

- 1 - Max. permitted coil voltage.
- 2 - Min. pick-up voltage with coil at ambient temperature.

Combinations

Code	Type of socket	Type of relay	Module	Retaining clip
48.12	95.05.7	50.12	—	095.71
48.P2	95.P5.7	50.12	—	095.71
48.32	95.05	50.12	99.02	095.01
48.31	95.03	40.31	99.02	095.01
48.52	95.05	40.52	99.02	095.01
48.61	95.05	40.61	99.02	095.01
48.62	95.05	40.62	99.02	095.01
48.P3	95.P3	40.31	99.02	095.91.3
48.P5	95.P5	40.52	99.02	095.91.3
48.P6	95.P5	40.61	99.02	095.91.3
48.P8	95.P5	40.62	99.02	095.91.3

B

Outline drawings

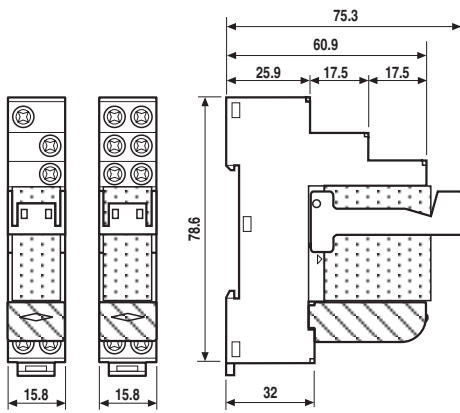

Types 48.31 48.32 / 48.52 / 48.61 / 48.62  
Screw terminal

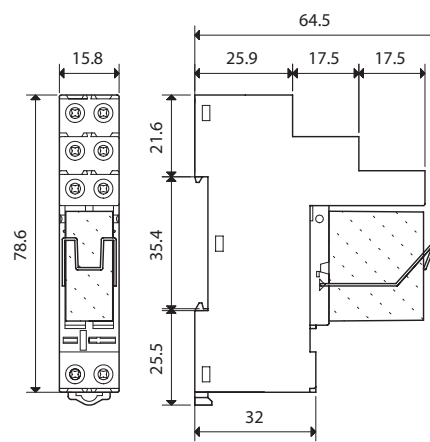

Type 48.12  
Screw terminal

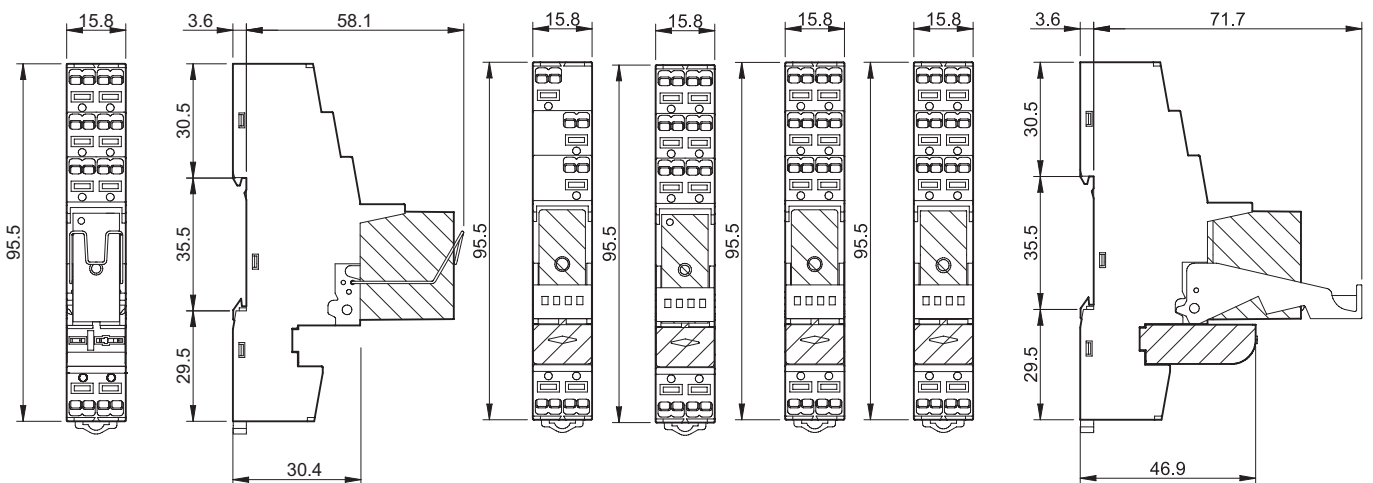

Types 48.P2  
Push-in terminal



Push-in terminal



Accessories

<b>8-way jumper link</b> for type 48.P3/P5/P6/P8	097.58
Rated values	10 A - 250 V

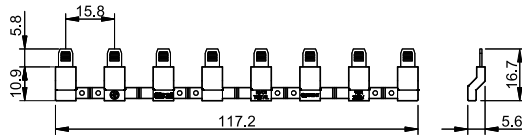

<b>2-way jumper link</b> for type 48.P3/P5/P6/P8	097.52
Rated values	10 A - 250 V

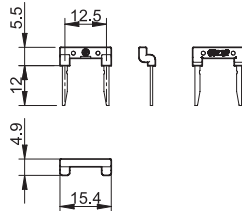

<b>2-way jumper link</b> for type 48.P3/P5/P6/P8	097.42
Rated values	10 A - 250 V

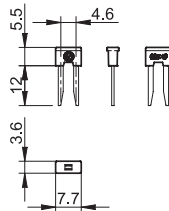

<b>Marker tag holder</b> for type 48.P3/P5/P6/P8 and 48.12/31/32/52/61/62	097.00
---	--------

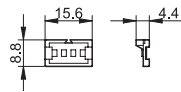

<b>8-way jumper link</b> for screw terminal version	095.18 (blue)	095.18.0 (black)
Rated values	10 A - 250 V	

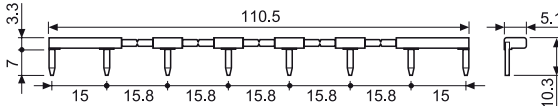

<b>Sheet of marker tags (CEMBRE Thermal transfer printers)</b> , plastic, 48 tags, 6 x 12 mm	060.48
---	--------



097.58



097.52



097.42



097.00



095.18

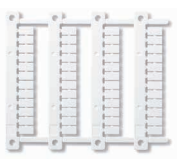

060.48

Packaging codes

How to code and identify retaining clip and packaging options for sockets.

Example:

4 8 . P 5 . 7 . 0 2 4 . 0 0 5 0 S P A

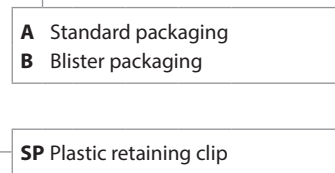



# Relay interface modules 8 - 10 - 16 A



Escalators



Road / tunnel  
lighting



Hoists and  
cranes



Carousel  
warehouses



Control panels



Panels for electrical  
distribution

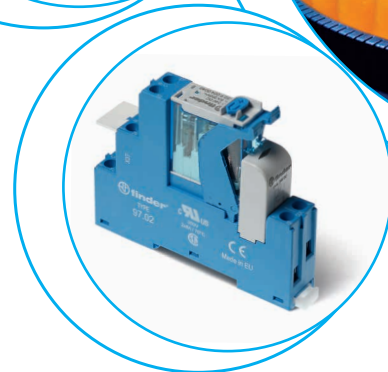
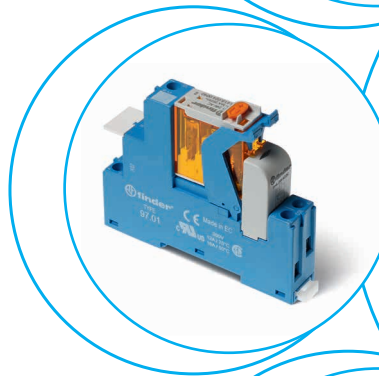



**1 & 2 CO relay interface modules,  
15.8 mm wide with Push-in terminal**  
**Ideal interface for PLC and electronic systems**

**Type 4C.P1**

- 1 CO 10 A

**Type 4C.P2**

- 2 CO 8 A

- AC coils or DC coils
- Supply status indication and coil suppression module as standard
- Identification label
- UL Listing (certain relay/socket combinations)
- 35 mm rail (EN 60715) mounting

4C.P1 / 4C.P2  
Push-in terminals



	4C.P1	4C.P2
	<ul style="list-style-type: none"> <li>• 1 CO 10 A</li> <li>• Push-in terminals</li> </ul>	<ul style="list-style-type: none"> <li>• 2 CO 8 A</li> <li>• Push-in terminals</li> </ul>
For outline drawing see page 7		
<b>Contact specification</b>		
Contact configuration	1 CO (SPDT)	2 CO (DPDT)
Rated current/Maximum peak current	A 10/25	8/15
Rated voltage/ Maximum switching voltage	V AC 250/440	250/440
Rated load AC1	VA 2500	2000
Rated load AC15 (230 V AC)	VA 750	350
Single phase motor rating (230 V AC)	kW 0.55	0.37
Breaking capacity DC1: 24/110/220 V	A 10/0.5/0.15	6/0.5/0.15
Minimum switching load	mW (V/mA) 300 (5/5)	300 (5/5)
Standard contact material	AgNi	AgNi
<b>Coil specification</b>		
Nominal voltage ( $U_N$ )	V AC (50/60 Hz) 12 - 24 - 110 - 120 - 230 V DC 12 - 24 - 125	12 - 24 - 110 - 120 - 230 12 - 24 - 125
Rated power AC/DC	VA (50 Hz)/W 1.2/0.5	1.2/0.5
Operating range	AC (0.8...1.1) $U_N$ DC (0.73...1.1) $U_N$	(0.8...1.1) $U_N$ (0.73...1.1) $U_N$
Holding voltage	AC/DC 0.8 $U_N$ / 0.4 $U_N$	0.8 $U_N$ / 0.4 $U_N$
Must drop-out voltage	AC/DC 0.2 $U_N$ / 0.1 $U_N$	0.2 $U_N$ / 0.1 $U_N$
<b>Technical data</b>		
Mechanical life AC/DC	cycles 10 · 10 <sup>6</sup>	10 · 10 <sup>6</sup>
Electrical life at rated load AC1	cycles 100 · 10 <sup>3</sup>	100 · 10 <sup>3</sup>
Operate/release time	ms 15/5 (AC) - 15/12 (DC)	10/3 (AC) - 10/10 (DC)
Insulation between coil and contacts (1.2/50 $\mu$ s)	kV 6 (8 mm)	6 (8 mm)
Dielectric strength between open contacts	V AC 1000	1000
Ambient temperature range	°C -40...+70	-40...+70
Protection category	IP 20	IP 20
<b>Approvals relay</b> (according to type)		

B

**1 & 2 CO relay interface modules,  
15.8 mm wide with screw terminal**

**Ideal interface for PLC and electronic systems**

**Type 4C.01**

- 1 CO 16 A

**Type 4C.02**

- 2 CO 8 A

- AC coils or DC coils
- Supply status indication and coil suppression module as standard
- Identification label
- UL Listing (certain relay/socket combinations)
- 35 mm rail (EN 60715) mounting

4C.01 / 4C.02  
Screw terminals



- 1 CO 16 A
- Screw terminals

- 2 CO 8 A
- Screw terminals

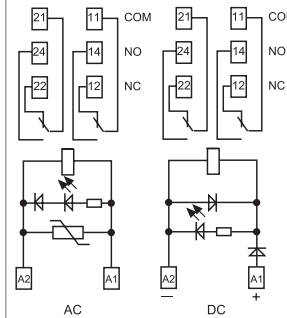
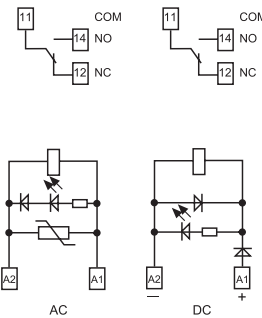

For outline drawing see page 7

**Contact specification**

Contact configuration		1 CO (SPDT)	2 CO (DPDT)
Rated current/Maximum peak current	A	16/25	8/15
Rated voltage/ Maximum switching voltage	V AC	250/440	250/440
Rated load AC1	VA	4000	2000
Rated load AC15 (230 V AC)	VA	750	350
Single phase motor rating (230 V AC)	kW	0.55	0.37
Breaking capacity DC1: 24/110/220 V	A	16/0.5/0.15	6/0.5/0.15
Minimum switching load	mW (V/mA)	300 (5/5)	300 (5/5)
Standard contact material		AgNi	AgNi

**Coil specification**

Nominal voltage (U <sub>N</sub> )	V AC (50/60 Hz)	12 - 24 - 110 - 120 - 230	12 - 24 - 110 - 120 - 230
	V DC	12 - 24 - 125	12 - 24 - 125
Rated power AC/DC	VA (50 Hz)/W	1.2/0.5	1.2/0.5
Operating range	AC	(0.8...1.1)U <sub>N</sub>	(0.8...1.1)U <sub>N</sub>
	DC	(0.73...1.1)U <sub>N</sub>	(0.73...1.1)U <sub>N</sub>
Holding voltage	AC/DC	0.8 U <sub>N</sub> / 0.4 U <sub>N</sub>	0.8 U <sub>N</sub> / 0.4 U <sub>N</sub>
Must drop-out voltage	AC/DC	0.2 U <sub>N</sub> / 0.1 U <sub>N</sub>	0.2 U <sub>N</sub> / 0.1 U <sub>N</sub>

**Technical data**

Mechanical life AC/DC	cycles	10 · 10 <sup>6</sup>	10 · 10 <sup>6</sup>
Electrical life at rated load AC1	cycles	100 · 10 <sup>3</sup>	100 · 10 <sup>3</sup>
Operate/release time	ms	15/5 (AC) - 15/12 (DC)	10/3 (AC) - 10/10 (DC)
Insulation between coil and contacts (1.2/50 μs)	kV	6 (8 mm)	6 (8 mm)
Dielectric strength between open contacts	V AC	1000	1000
Ambient temperature range	°C	≤ 12 A: -40...+70 / >12 A: -40...+50	-40...+70
Protection category		IP 20	IP 20

**Approvals relay** (according to type)



## Ordering information

Example: 4C series, 35 mm rail (EN 60715) mount, Push-in terminal relay interface module, 1 CO 10 A contacts, 24 V DC coil, green LED + diode.

**4 C . P 1 . 9 . 0 2 4 . 0 0 5 0**

**Series** ————

**Type** ————  
 0 = 35 mm rail (EN 60715) mount screw terminal socket  
 P = 35 mm rail (EN 60715) mount Push-in terminal socket

**No. of poles** ————  
 1 = 1 pole, 10/16 A  
 2 = 2 pole, 8 A

**Coil version** ————  
 8 = AC (50/60 Hz)  
 9 = DC

**Coil voltage** ————  
 See coil specifications

**A: Contact material**  
 0 = AgNi  
 4 = AgSnO<sub>2</sub>  
 5 = AgNi + Au

**B: Contact circuit**  
 0 = CO (nPDT)

**D: Special versions**  
 0 = Standard

**C: Options**  
 5 = Standard for DC:  
 green LED + diode (polarity +A1)  
 6 = Standard for AC:  
 green LED + Varistor

**Selecting features and options: only combinations in the same row are possible.**  
 Preferred selections for best availability are shown in **bold**.

Type	Coil version	A	B	C	D
4C.02	AC	<b>0 - 5</b>	<b>0</b>	<b>6</b>	<b>0</b>
4C.P2	DC	<b>0 - 5</b>	<b>0</b>	<b>5</b>	<b>0</b>
4C.01	AC	<b>0 - 4 - 5</b>	<b>0</b>	<b>6</b>	<b>0</b>
4C.P1	DC	<b>0 - 4 - 5</b>	<b>0</b>	<b>5</b>	<b>0</b>

## Technical data

Insulation					
Insulation according to EN 61810-1	insulation rated voltage	V	250	440	
	rated impulse withstand voltage	kV	4	4	
	pollution degree		3	2	
	overvoltage category		III	III	
Insulation between coil and contacts (1.2/50 μs)	kV	6 (8 mm)			
Dielectric strength between open contacts	V AC	1000			
Dielectric strength between adjacent contacts	V AC	2000			
Insulation between coil terminals					
Rated impulse voltage (surge) differential mode (according to EN 61000-4-5)	kV (1.2/50 μs)	2			
Other data					
Bounce time: NO/NC	ms	2/6 (4C.01/P1)		1/4 (4C.02/P2)	
Vibration resistance (10...150)Hz: NO/NC	g	20/12			
Power lost to the environment	without contact current	W	0.6		
	with rated current	W	1.6 (4C.01/P1)		2 (4C.02/P2)
Terminals		<b>4C.01/4C.02</b>		<b>4C.P1/4C.P2</b>	
Wire strip length	mm	8		8	
Screw torque	Nm	0.8		—	
Min. wire size		solid cable	stranded cable	solid cable	stranded cable
	mm <sup>2</sup>	0.5	0.5	0.5	0.5
	AWG	21	21	21	21
Max. wire size		solid cable	stranded cable	solid cable	stranded cable
	mm <sup>2</sup>	1 x 6 / 2 x 2.5	1 x 4 / 2 x 2.5	2 x 1.5 / 1 x 2.5	2 x 1.5 / 1 x 2.5
	AWG	1 x 10 / 2 x 14	1 x 12 / 2 x 14	2 x 16 / 1 x 14	2 x 16 / 1 x 14



## Contact specification

### F 4C - Electrical life (AC) v contact current

Types 4C.02/P2

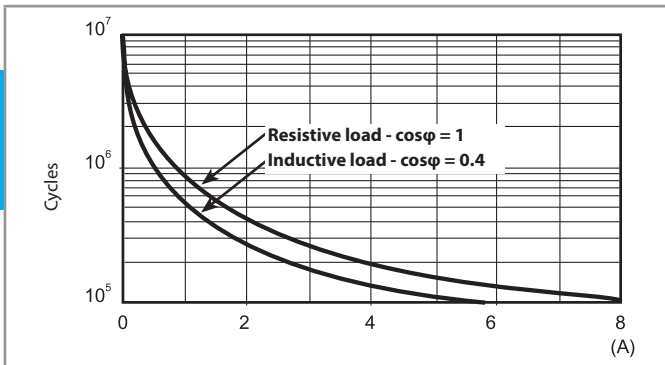

### F 4C - Electrical life (AC) v contact current

Types 4C.01/P1

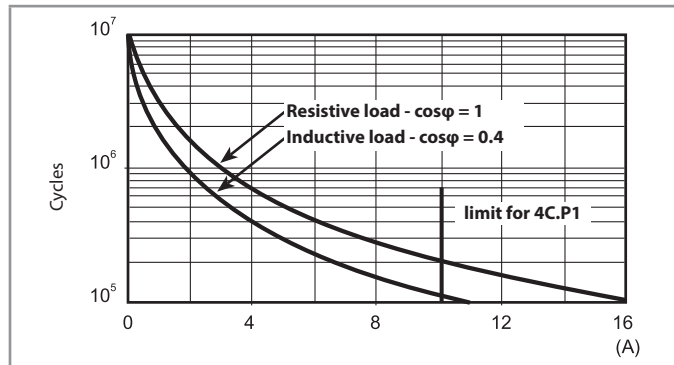

### H 4C - Maximum DC1 breaking capacity

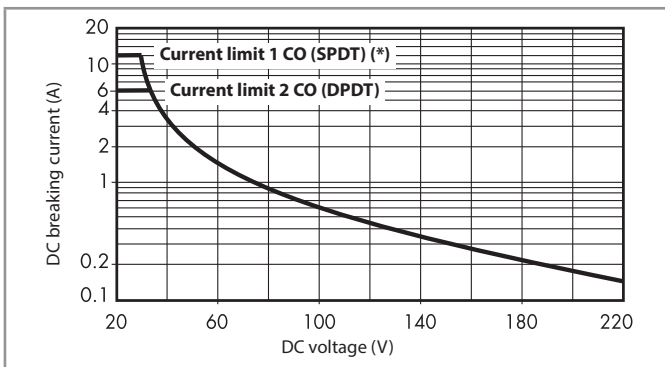

(\*) Type 4C.01 = 12 A, Type 4C.P1 = 10 A

- When switching a resistive load (DC1) having voltage and current values under the curve, an electrical life of  $\geq 100 \cdot 10^3$  can be expected.
- In the case of DC13 loads, the connection of a diode in parallel with the load will permit a similar electrical life as for a DC1 load.  
Note: the release time for the load will be increased.

## Coil specifications

### DC coil data

Nominal voltage $U_N$	Coil code	Operating range		Resistance $R$	Rated coil consumption $I$ at $U_N$
		$U_{min}$	$U_{max}$		
V		V	V	$\Omega$	mA
12	9.012	8.8	13.2	300	40
24	9.024	17.5	26.4	1200	20
125	9.125	91.2	138	32000	3.9

### AC coil data

Nominal voltage $U_N$	Coil code	Operating range		Resistance $R$	Rated coil consumption $I$ at $U_N$
		$U_{min}$	$U_{max}$		
V		V	V	$\Omega$	mA
12	8.012	9.6	13.2	80	90
24	8.024	19.2	26.4	320	45
110	8.110	88	121	6900	9.4
120	8.120	96	132	9000	8.4
230	8.230	184	253	28000	5

### R 4C - DC coil operating range v ambient temperature

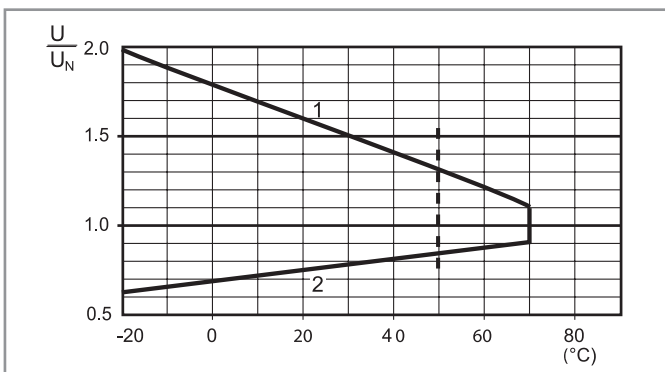

### R 4C - AC coil operating range v ambient temperature

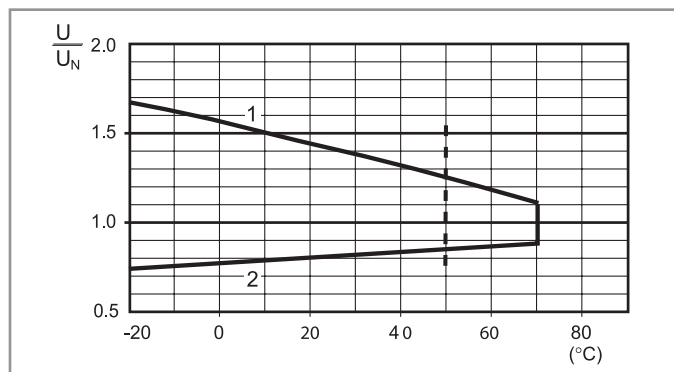

1 - Max. permitted coil voltage.

2 - Min. pick-up voltage with coil at ambient temperature.

1 - Max. permitted coil voltage.

2 - Min. pick-up voltage with coil at ambient temperature.

----- Temperature limit for 4C.01 with 16 A contact current.

### Combinations

Code	Type of socket	Type of relay	Module	Retaining clip
4C.P1	97.P1	46.61	99.02	097.01
4C.P2	97.P2	46.52	99.02	097.01
4C.01	97.01	46.61	99.02	097.01
4C.02	97.02	46.52	99.02	097.01

Certain relay/socket combinations

### Outline drawings

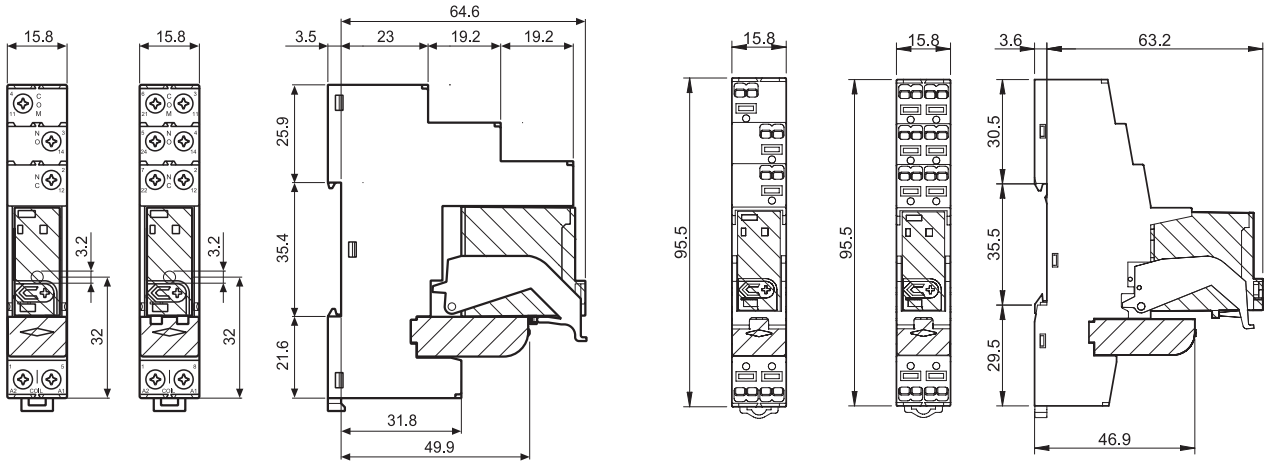

Types 4C.01 / 4C.02  
Screw terminals



Types 4C.P1 / 4C.P2  
Push-in terminals



### Accessories

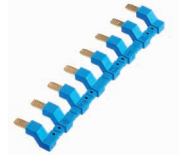

097.58

<b>8-way jumper link</b> for type 4C.P1 and 4C.P2	097.58
Rated values	10 A - 250 V

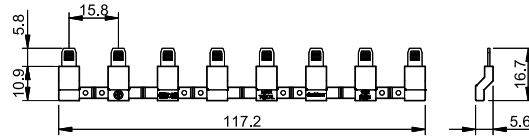

097.52

<b>2-way jumper link</b> for type 4C.P1 and 4C.P2	097.52
Rated values	10 A - 250 V

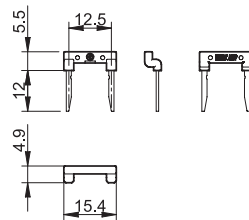

097.42

<b>2-way jumper link</b> for type 4C.P1 and 4C.P2	097.42
Rated values	10 A - 250 V

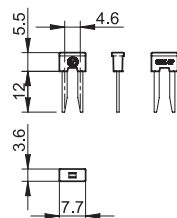

Accessories



097.00

Marker tag holder for type 4C.P1/P2/01/02

097.00

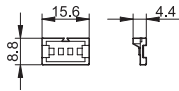

8-way jumper link for 4C.01 and 4C.02

095.18 (blue)

Rated values

10 A - 250 V

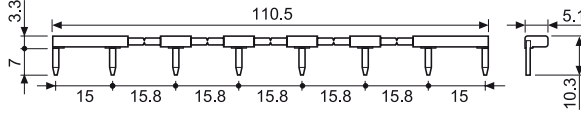

Sheet of marker tags (CEMBRE Thermal transfer printers), marker tag holder 097.00 or on the relay 46 series, plastic, 48 tags, 6 x 12 mm

060.48

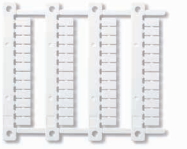

060.48

Packaging codes

How to code and identify retaining clip and packaging options for relay interface module.

Example:

4 C . P 1 . 9 . 0 2 4 . 0 0 5 0 S P A

A Standard packaging  
B Blister packaging

SP Plastic retaining clip



# Relay interface modules 6 - 7 - 10 A



Control panels



Packaging  
machines



Shipyards



Textile  
machines



Carousel  
warehouses



Panels for electrical  
distribution



Hoists and cranes



Wood-processing  
machines

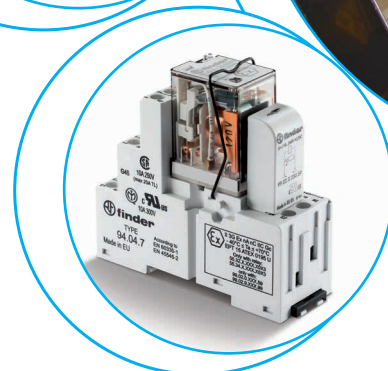
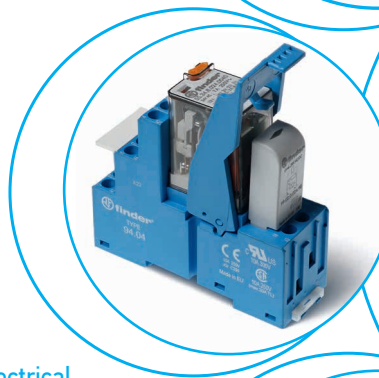
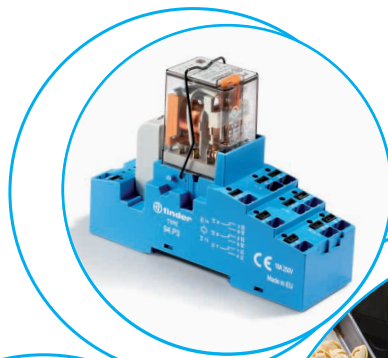



**3 & 4 CO relay interface modules,  
31 mm wide with Push-in terminals**  
**Ideal interface for PLC and electronic systems**

**Type 58.P3**

- 3 CO 10 A
- Push-in terminals

**Type 58.P4**

- 4 CO 7 A
- Push-in terminals

- AC coils or DC coils
- Supply status indication and EMC coil suppression module as standard
- Identification label
- Cadmium Free contacts
- UL Listing (certain relay/socket combinations)
- **Atex** compliant (Ex ec nC) option available
- **HazLoc** Class I Div. 2 Groups A, B, C, D - T5 option available
- 35 mm rail (EN 60715) mounting

58.P3 / 58.P4  
Push-in terminals



For outline drawing see page 10

**Contact specification**

Contact configuration		3 CO (3PDT)	4 CO (4PDT)
Rated current/Maximum peak current	A	10/20	7/15
Rated voltage/ Maximum switching voltage	V AC	250/400	250/250
Rated load AC1	VA	2500	1750
Rated load AC15 (230 V AC)	VA	500	350
Single phase motor rating (230 V AC)	kW	0.37	0.125
Breaking capacity DC1: 24/110/220 V	A	10/0.5/0.25	7/0.5/0.25
Minimum switching load	mW (V/mA)	300 (5/5)	300 (5/5)
Standard contact material		AgNi	AgNi

**Coil specification**

Nominal voltage (U <sub>N</sub> )	V AC (50/60 Hz)	12 - 24 - 48 - 110 - 120 - 230	12 - 24 - 48 - 110 - 120 - 230
	V DC	12 - 24 - 48 - 125	12 - 24 - 48 - 125
Rated power AC/DC	VA (50 Hz)/W	1.5/1	1.5/1
Operating range	AC	(0.8...1.1)U <sub>N</sub>	(0.8...1.1)U <sub>N</sub>
	DC	(0.8...1.1)U <sub>N</sub>	(0.8...1.1)U <sub>N</sub>
Holding voltage	AC/DC	0.8 U <sub>N</sub> / 0.5 U <sub>N</sub>	0.8 U <sub>N</sub> / 0.5 U <sub>N</sub>
Must drop-out voltage	AC/DC	0.2 U <sub>N</sub> / 0.1 U <sub>N</sub>	0.2 U <sub>N</sub> / 0.1 U <sub>N</sub>

**Technical data**

Mechanical life AC/DC	cycles	20 · 10 <sup>6</sup> / 50 · 10 <sup>6</sup>	20 · 10 <sup>6</sup> / 50 · 10 <sup>6</sup>
Electrical life at rated load AC1	cycles	200 · 10 <sup>3</sup>	150 · 10 <sup>3</sup>
Operate/release time	ms	10/5 (AC) - 10/15 (DC)	11/3 (AC) - 11/15 (DC)
Insulation between coil and contacts (1.2/50 μs)	kV	3.6	3.6
Dielectric strength between open contacts	V AC	1000	1000
Ambient temperature range	°C	-40...+70	-40...+70
Protection category		IP 20	IP 20

**Approvals relay** (according to type)

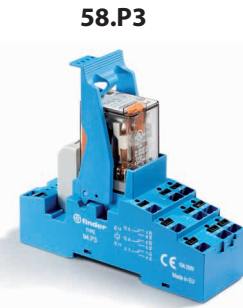

- 3 CO 10 A
- Push-in terminals

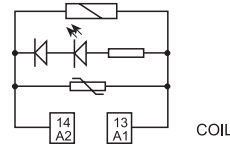
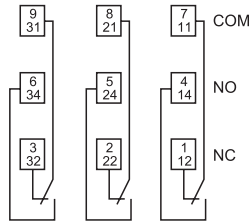

Example: AC



- 4 CO 7 A
- Push-in terminals

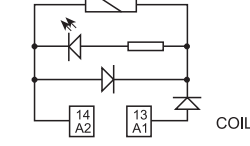
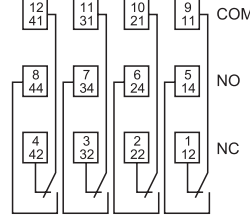

Example: DC



**2, 3 & 4 CO relay interface modules,  
27 mm wide with Screw terminals**  
**Ideal interface for PLC and electronic systems**

**Type 58.32**

- 2 CO 10 A
- Screw terminals

**Type 58.33**

- 3 CO 10 A
- Screw terminals

**Type 58.34**

- 4 CO 7 A
- Screw terminals

- AC coils or DC coils
- Supply status indication and EMC coil suppression module as standard
- Identification label
- Cadmium Free contacts
- UL Listing (certain relay/socket combinations)
- 35 mm rail (EN 60715) mounting

58.32 / 58.33 / 58.34  
Screw terminals



For outline drawing see page 10

**Contact specification**

Contact configuration		2 CO (DPDT)	3 CO (3PDT)	4 CO (4PDT)
Rated current/Maximum peak current	A	10/20	10/20	7/15
Rated voltage/ Maximum switching voltage	V AC	250/400	250/400	250/250
Rated load AC1	VA	2500	2500	1750
Rated load AC15 (230 V AC)	VA	500	500	350
Single phase motor rating (230 V AC)	kW	0.37	0.37	0.125
Breaking capacity DC1: 24/110/220 V	A	10/0.5/0.25	10/0.5/0.25	7/0.5/0.25
Minimum switching load	mW (V/mA)	300 (5/5)	300 (5/5)	300 (5/5)
Standard contact material		AgNi	AgNi	AgNi

**Coil specification**

Nominal voltage (U <sub>N</sub> )	V AC (50/60 Hz)	12 - 24 - 48 - 110 - 120 - 230	12 - 24 - 48 - 110 - 120 - 230	12 - 24 - 48 - 110 - 120 - 230
	V DC	12 - 24 - 48 - 125	12 - 24 - 48 - 125	12 - 24 - 48 - 125
Rated power AC/DC	VA (50 Hz)/W	1.5/1	1.5/1	1.5/1
Operating range	AC	(0.8...1.1)U <sub>N</sub>	(0.8...1.1)U <sub>N</sub>	(0.8...1.1)U <sub>N</sub>
	DC	(0.8...1.1)U <sub>N</sub>	(0.8...1.1)U <sub>N</sub>	(0.8...1.1)U <sub>N</sub>
Holding voltage	AC/DC	0.8 U <sub>N</sub> / 0.5 U <sub>N</sub>	0.8 U <sub>N</sub> / 0.5 U <sub>N</sub>	0.8 U <sub>N</sub> / 0.5 U <sub>N</sub>
Must drop-out voltage	AC/DC	0.2 U <sub>N</sub> / 0.1 U <sub>N</sub>	0.2 U <sub>N</sub> / 0.1 U <sub>N</sub>	0.2 U <sub>N</sub> / 0.1 U <sub>N</sub>

**Technical data**

Mechanical life AC/DC	cycles	20 · 10 <sup>6</sup> / 50 · 10 <sup>6</sup>	20 · 10 <sup>6</sup> / 50 · 10 <sup>6</sup>	20 · 10 <sup>6</sup> / 50 · 10 <sup>6</sup>
Electrical life at rated load AC1	cycles	200 · 10 <sup>3</sup>	200 · 10 <sup>3</sup>	150 · 10 <sup>3</sup>
Operate/release time	ms	10/5 (AC) - 10/15 (DC)	10/5 (AC) - 10/15 (DC)	11/3 (AC) - 11/15 (DC)
Insulation between coil and contacts (1.2/50 μs)	kV	3.6	3.6	3.6
Dielectric strength between open contacts	V AC	1000	1000	1000
Ambient temperature range	°C	-40...+70	-40...+70	-40...+70
Protection category		IP 20	IP 20	IP 20

**Approvals relay** (according to type)



58.32	58.33	58.34
<ul style="list-style-type: none"> <li>• 2 CO 10 A</li> <li>• Screw terminals</li> </ul>	<ul style="list-style-type: none"> <li>• 3 CO 10 A</li> <li>• Screw terminals</li> </ul>	<ul style="list-style-type: none"> <li>• 4 CO 7 A</li> <li>• Screw terminals</li> </ul>
<p>Example: AC</p>	<p>Example: DC</p>	<p>Example: AC</p>

**2 & 4 CO relay interface modules,  
27 mm wide with Screw or sockets version  
with Push-in terminals**

**ATEX compliant (EX ec nC)  
HazLoc Class I Div. 2 Groups A, B, C, D - T5  
compliant**

**Type 58.32 - x0xx**

- 2 CO 10 A
- Screw terminals
- Push-in terminals sockets version (94.Px) available

**Type 58.34 - x0xx**

- 4 CO 6 A
- Screw terminals
- Push-in terminals sockets version (94.Px) available
- AC coils or DC coils
- Supply status indication and EMC coil suppression module as standard
- Mechanical indicator - optional on 2 & 4 CO types
- Identification label
- Cadmium Free contacts
- UL Listed
- Complies with:
  - EN 60079-0:2012+A11:2013;
  - EN 60079-15:2010; EN 60079-7:2015 and 2014/34/UE
- 35 mm rail (EN 60715) mounting

58.32 / 58.34 - x0xx  
Screw terminals



For outline drawing see page 10

**Contact specification**

Contact configuration		2 CO (DPDT)	4 CO (4PDT)
Rated current/Maximum peak current*	A	10/20	6/15
Rated voltage/ Maximum switching voltage	V AC	250/400	250/250
Rated load AC1	VA	2500	1500
Rated load AC15 (230 V AC)	VA	500	350
Single phase motor rating (230 V AC)	kW	0.37	0.125
Breaking capacity DC1: 24/110/220 V	A	10/0.25/0.12	6/0.25/0.12
Minimum switching load	mW (V/mA)	300 (5/5)	300 (5/5)
Standard contact material		AgNi	AgNi

**Coil specification**

Nominal voltage (U <sub>N</sub> )	V AC (50/60 Hz)	12 - 24 - 48 - 110 - 120 - 230	12 - 24 - 48 - 110 - 120 - 230
	V DC	12 - 24 - 48 - 125	12 - 24 - 48 - 125
Rated power AC/DC	VA (50 Hz)/W	1.5/1	1.5/1
Operating range	AC	(0.8...1.1)U <sub>N</sub>	(0.8...1.1)U <sub>N</sub>
	DC	(0.8...1.1)U <sub>N</sub>	(0.8...1.1)U <sub>N</sub>
Holding voltage	AC/DC	0.8 U <sub>N</sub> / 0.5 U <sub>N</sub>	0.8 U <sub>N</sub> / 0.5 U <sub>N</sub>
Must drop-out voltage	AC/DC	0.2 U <sub>N</sub> / 0.1 U <sub>N</sub>	0.2 U <sub>N</sub> / 0.1 U <sub>N</sub>

**Technical data**

Mechanical life AC/DC	cycles	20 · 10 <sup>6</sup> / 50 · 10 <sup>6</sup>	20 · 10 <sup>6</sup> / 50 · 10 <sup>6</sup>
Electrical life at rated load AC1	cycles	150 · 10 <sup>3</sup>	150 · 10 <sup>3</sup>
Operate/release time	ms	11/3 (AC) - 11/15 (DC)	11/3 (AC) - 11/15 (DC)
Insulation between coil and contacts (1.2/50 μs)	kV	3.6	3.6
Dielectric strength between open contacts	V AC	1000	1000
Ambient temperature range*	°C	-40...+70*	-40...+70*
Protection category		IP 20	IP 20

**Approvals relay** (according to type)

**58.32 - x0xx**

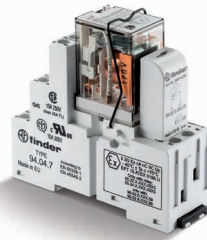

- 2 CO 10 A
- Screw terminals or Push-in terminals sockets version (94.Px) available
- Atex, Hazardous Location compliant

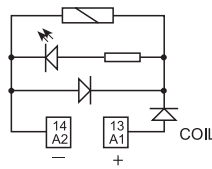
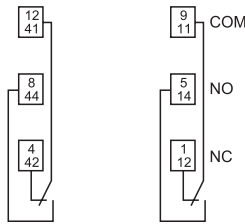

Example: DC

**58.34 - x0xx**

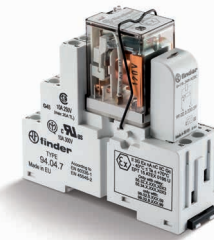

- 4 CO 6 A
- Screw terminals or Push-in terminals sockets version (94.Px) available
- Atex, Hazardous Location compliant

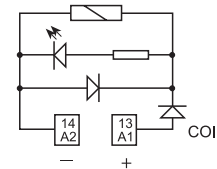
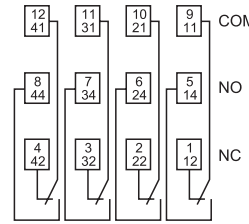

Example: DC

\* See page 7 for details of rated current and ambient temperature approval characteristic



### Ordering information

Example: 58 series, 35 mm rail (EN 60715) mounting, Push-in terminals interface module, 4 CO, 24 V DC coil, green LED + diode.

**B** Series **5 8 . P** 4 . 9 . 0 2 4 . **A** 0 **B** 0 **C** 5 **D** 0

**Series** ————

**Type** ————  
 3 = Screw terminals  
 35 mm rail (EN 60715) mount  
 P = Push-in terminals  
 35 mm rail (EN 60715) mount

**No. of poles** ————  
 2 = 2 pole, 10 A  
 3 = 3 pole, 10 A  
 4 = 4 pole, 7 A

**Coil version** ————  
 8 = AC (50/60 Hz)  
 9 = DC

**Coil voltage** ————  
 See coil specifications

**A: Contact material**  
 0 = AgNi Standard  
 5 = AgNi + Au

**B: Contact circuit**  
 0 = CO (nPDT)

**D: Special versions**  
 0 = Standard

**C: Options**  
 5 = Standard DC: green LED + diode (polarity +A1)  
 6 = Standard AC: green LED + Varistor

**Selecting features and options: only combinations in the same row are possible.**  
 Preferred selections for best availability are shown in **bold**.

Type	Coil version	A	B	C	D
58.P3/P4/32/33/34	AC	<b>0</b> - 5	0	<b>6</b>	0
58.P3/P4/32/33/34	DC	<b>0</b> - 5	0	<b>5</b>	0

### Ordering information ATEX and Hazardous Location versions

Example: 58 series, 35 mm rail (EN 60715), screw terminal interface module, 4 CO, 120 V AC, green LED, mechanical indicator, ATEX and HazLoc Version.

**5 8 . 3** 4 . 8 . 1 2 0 . **A** 0 **B** 0 **C** 4 **D** 9

**Series** ————

**Type** ————  
 3 = Screw terminals  
 35 mm rail (EN 60715) mount  
 P = Push-in terminals  
 35 mm rail (EN 60715) mount

**No. of poles** ————  
 2 = 2 pole, 10 A  
 4 = 4 pole, 6 A

**Coil version** ————  
 8 = AC (50/60 Hz)  
 9 = DC

**Coil voltage** ————  
 See coil specifications

**A: Contact material**  
 0 = AgNi Standard  
 2 = AgCdO  
 5 = AgNi + Au

**B: Contact circuit**  
 0 = CO (nPDT)

**D: Special versions**  
 8 = Atex (Ex ec nC) and HazLoc Class I Div. 2 compliant without mechanical indicator  
 9 = Atex (Ex ec nC) and HazLoc Class I Div. 2 compliant with mechanical indicator

**C: Options (Not for 58.Px version)**  
 4 = Module 99 LED (AC/DC)  
 5 = Module 99 LED + Diode (DC)  
 6 = Module 99 LED + Varistor (AC/DC)  
 7 = Timer 86.30 (12-24 V AC/DC)

**Selecting features and options: only combinations in the same row are possible.**

Type	Coil version	A	B	C	D
58.3x	AC/DC	0 - 2 - 5	0	4 - 5 - 6 - 7	8 - 9
58.Px	AC/DC	0 - 2 - 5	0	0	8 - 9

## Technical data

Insulation				
Insulation according to EN 61810-1	insulation rated voltage	V	400 (2-3 pole)	250 (4 pole)
	rated impulse withstand voltage	kV	3.6 (2-3 pole)	2.5 (4 pole)
	pollution degree		2	2
	overvoltage category		III	II
Insulation between coil and contacts (1.2/50 µs)		kV	3.6	
Dielectric strength between open contacts		V AC	1000	
Dielectric strength between adjacent contacts		V AC	2000 (58.32,58.33, 58.P3)	1550 (58.34, 58.P4)
Insulation between coil terminals				
Rated impulse voltage (surge) differential mode (according to EN 61000-4-5)		kV (1.2/50 µs)	4	
Other data				
Bounce time: NO/NC		ms	1/3	
Vibration resistance (10...55)Hz: NO/NC		g	6/6	
Power lost to the environment	without contact current	W	1	
	with rated current	W	3 (58.32, 58.34, 58.P4)	4 (58.P3, 58.33)
			<b>58.32/33/34 (screw terminals)</b>	<b>58.P3/P4 (Push-in terminals)</b>
Wire strip length		mm	8	
Screw torque		Nm	0.5	
Min. wire size		mm <sup>2</sup>	solid cable	stranded cable
			0.5	0.5
			AWG 21	21
Max. wire size		mm <sup>2</sup>	solid cable	stranded cable
			1 x 6 / 2 x 2.5	1 x 4 / 2 x 2.5
			AWG 1 x 10 / 2 x 14	1 x 12 / 2 x 14
			solid cable	stranded cable
			2 x 1.5 / 1 x 2.5	2 x 1.5 / 1 x 2.5
			2 x 16 / 1 x 14	2 x 16 / 1 x 14

## ATEX - HazLoc - Electrical characteristics

Max current @ 70 °C (max temperature ATEX applications)		Single piece mount	> 1 piece mount	
Type 58.x2	A	10	7	
Type 58.x4	A	6	5	
Max current @ 40 °C (max temperature Hazloc applications)		Single piece mount	> 1 piece mount	
Type 58.x2	A	9	9	
Type 58.x4	A	5	5	
Terminal				
Wire strip length		mm	8	
Screw torque		Nm	0.5	
Wire size		mm <sup>2</sup>	solid cable	stranded cable
			1 x 2.5	2 x 1.5
			AWG 1 x 12	2 x 16

## Markings - ATEX versions - ATEX, II 3G Ex ec nC IIC Gc

MARKING	
	Specific marking of explosion protection
<b>II</b>	Component for surface plant (different from mines)
<b>3</b>	Category 3: normal level of protection
<b>GAS</b>	<b>G</b> Explosive atmosphere due to presence of combustible gas vapour or mist
	<b>Ex ec</b> Increased Safety
	<b>Ex nC</b> Sealed device (type of protection for category 3G)
	<b>IIC</b> Gas group
	<b>Gc</b> Equipment Protection Level
-40 °C ≤ Ta ≤ +70 °C Ambient temperature	
<b>EPTI 15 ATEX 0195 U</b> EPTI: laboratory which issues the CE type certificate 15: year of issue of certificate 0195: number of CE type certificate U: ATEX component	

## Markings - Hazardous Location Class I Div. 2 Groups A, B, C, D - T5 and other data

HazLoc Class I Div. 2 Group A, B, C, D - T5		Meaning
Class I		Areas in which flammable gases and vapours may be present
Div. 2		Low probability to find ignitable hazardous concentration because it is typically present in closed system from which can escape through breakdown or accidental rupture
Group A, B, C, D		Kind of combustible, flammable gases and vapours can be in the atmosphere
Permissible Surface temperature		
T5	100 °C	212 °F

## ATEX and HazLoc - Electrical characteristics

Interface Code	Atex current [A] rating -40...+70°C		HazLoc current [A] rating -25...40°C group mounting	
	Single mounting	Group mounting	24 V DC	230 V AC
58.32.x.xxx	10	7	9	9
58.34.x.xxx	6	5	5	5
58.P2.x.xxx	10	7	9	9
58.P4.x.xxx	6	5	5	5



## Contact specification

**F 58 - Electrical life (AC) v contact current**  
2 & 3 pole relays

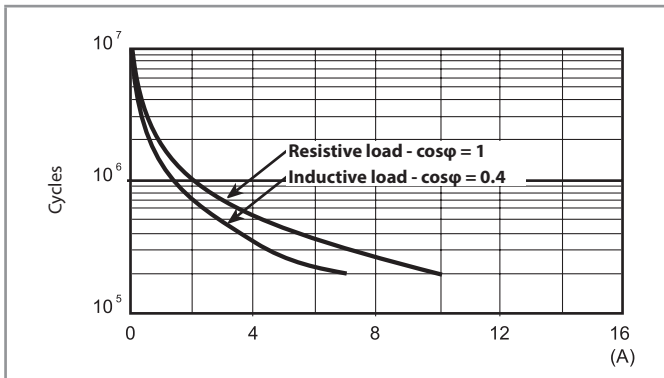

**F 58 - Electrical life (AC) v contact current**  
4 pole relay

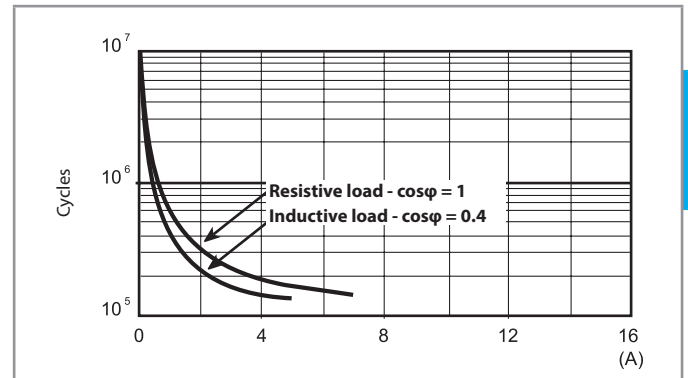

**H 58 - Maximum DC1 breaking capacity**

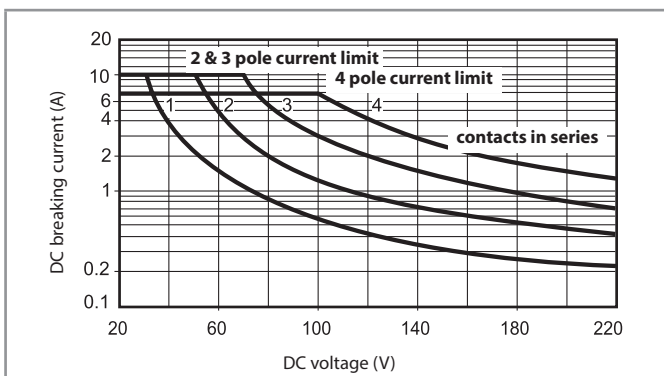

- When switching a resistive load (DC1) having voltage and current values under the curve, an electrical life of  $\geq 100 \cdot 10^3$  can be expected.
- In the case of DC13 loads, the connection of a diode in parallel with the load will permit a similar electrical life as for a DC1 load.  
Note: the release time for the load will be increased.

## Coil specifications

**DC coil data**

Nominal voltage	Coil code	Operating range		Resistance	Rated coil absorption
		$U_{min}$	$U_{max}$		
$U_N$		V	V	R	I at $U_N$
V		V	V	$\Omega$	mA
12	9.012	9.6	13.2	140	86
24	9.024	19.2	26.4	600	40
48	9.048	38.4	52.8	2400	20
125	9.125	100	138	17300	7.2

**AC coil data**

Nominal voltage	Coil code	Operating range		Resistance	Rated coil absorption
		$U_{min}$	$U_{max}$		
$U_N$		V	V	R	I at $U_N$ (50 Hz)
V		V	V	$\Omega$	mA
12	8.012	9.6	13.2	50	97
24	8.024	19.2	26.4	190	53
48	8.048	38.4	52.8	770	25
110	8.110	88	121	4000	12.5
120	8.120	96	132	4700	12
230	8.230	184	253	17000	6

**R 58 - DC coil operating range v ambient temperature**

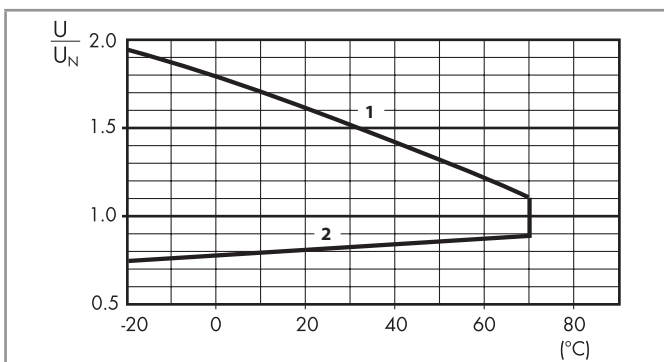

- 1 - Max. permitted coil voltage.  
2 - Min. pick-up voltage with coil at ambient temperature.

**R 58 - AC coil operating range v ambient temperature**

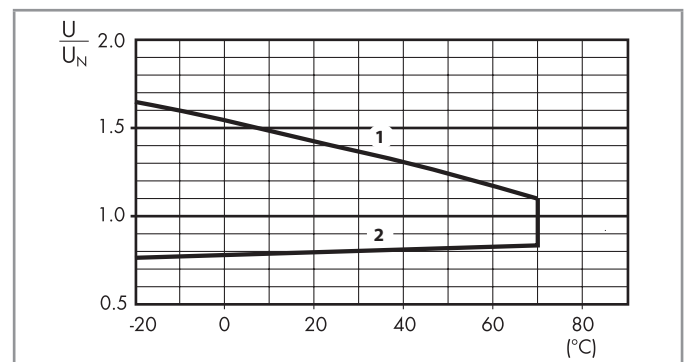

- 1 - Max. permitted coil voltage.  
2 - Min. pick-up voltage with coil at ambient temperature.

**Combinations**

Code	Type of socket	Type of relay	Module	Retaining clip
58.P3	94.P3	55.33	99.02	094.91.3
58.P4	94.P4	55.34	99.02	094.91.3
58.32	94.02	55.32	99.02	094.91.3
58.33	94.03	55.33	99.02	094.91.3
58.34	94.04	55.34	99.02	094.91.3

Certain relay/socket combinations

**B Outline drawings**

Type 58.32  
Screw terminals

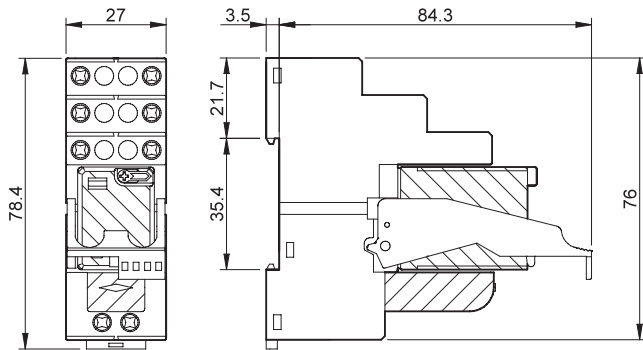

Type 58.33  
Screw terminals

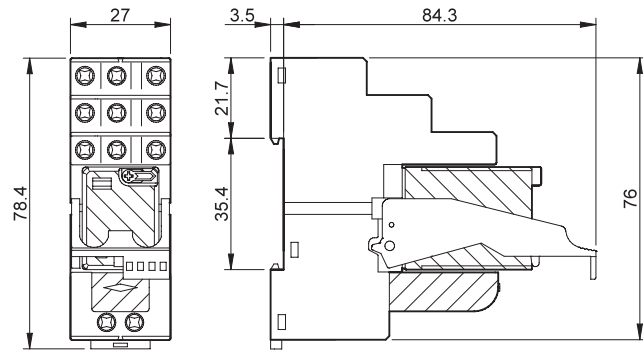

Type 58.34  
Screw terminals

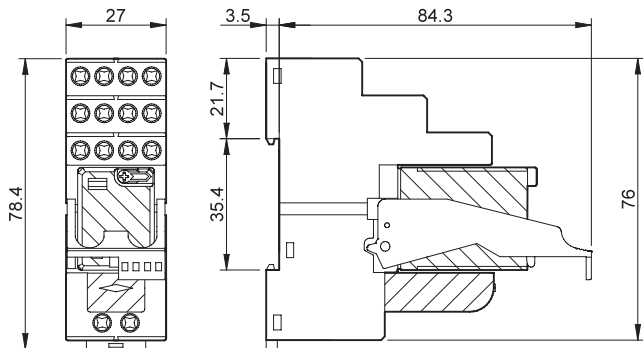

Type 58.P3  
Push-in terminals

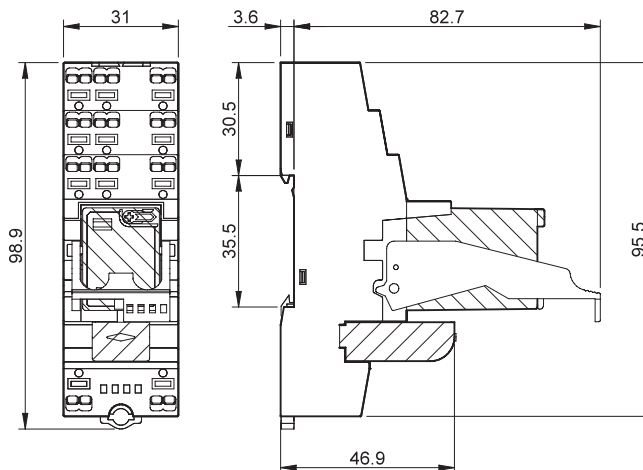

Type 58.P4  
Push-in terminals

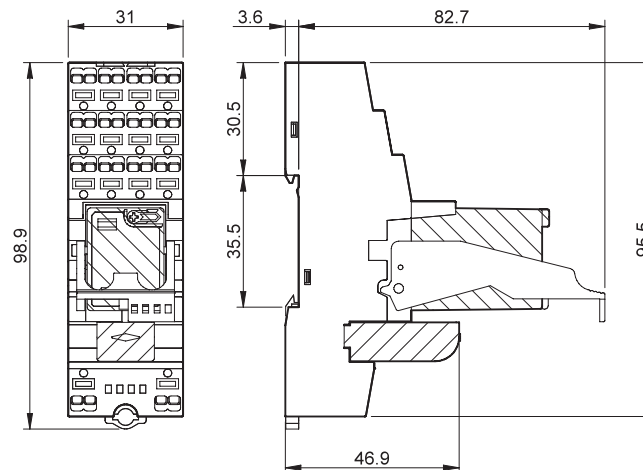

### Accessories



094.52.1

<b>2-way jumper link</b> for type 58.P3 and 58.P4	094.52.1
Rated values	10 A - 250 V

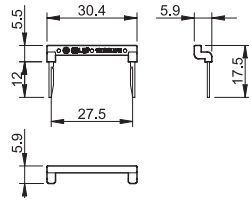

097.52

<b>2-way jumper link</b> for type 58.P3 and 58.P4	097.52
Rated values	10 A - 250 V

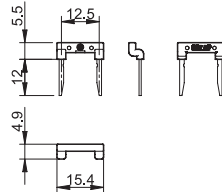

097.00

<b>Marker tag holder</b> for type 58.P3, 58.P4, 58.32, 58.33 and 58.34	097.00
--	--------

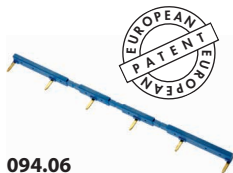
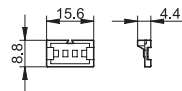

094.06

<b>6-way jumper link</b> for type 58.32, 58.33, 58.34	094.06 (blue)	094.06.0 (black)
Rated values	10 A - 250 V	

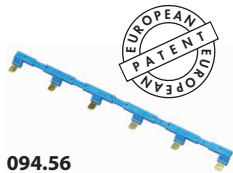
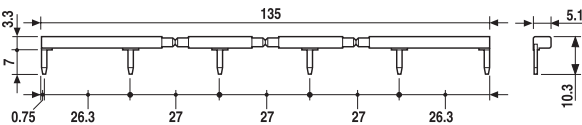

094.56

<b>6-way jumper link</b> for type 58.P3 and 58.P4	094.56 (blue)
Rated values	10 A - 250 V

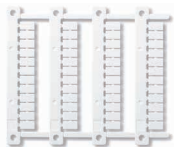
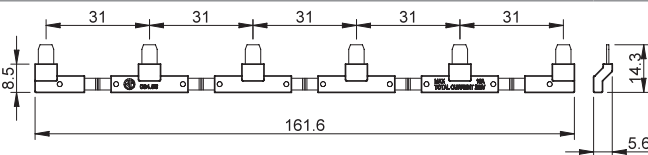

060.48

<b>Sheet of marker tags</b> , plastic, 48 tags, 6 x 12 mm	060.48
---	--------

### Packaging codes

How to code and identify retaining clip and packaging options for sockets.

Example:

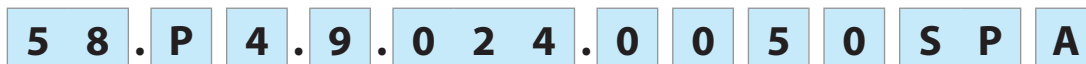

**A** Standard packaging  
**B** Blister packaging

**SP** Plastic retaining clip  
**SM** Metallic retaining clip (58.P2/  
P4/32/34) Atex and HazLoc  
Versions only



# Relay actuators & Status indicating modules



Panels for  
electrical  
distribution





**Auto/Off/On output module 10 A**

- Auto/Off/On output module intended to permit the automatic control of pumps, blowers or motor groups. Or, in the case of installation, maintenance or failure, to permit the load equipment to be turned "Off" or turned "On"
- Ideal interface for PLC and electronic systems
- Only 11.2 mm wide
- 3 function selector switch:
  - Auto: works as a monostable relay (following A3 input)
  - Off: relay permanently OFF
  - On: relay permanently ON
- 24 V AC/DC supply and module input
- 35 mm rail (EN 60715) mounting

**Application examples:**

- control of pumps, blowers or motor groups
- primarily suited to Industrial control systems

**Wiring diagram**

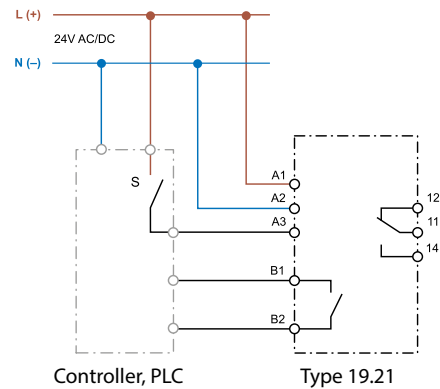

For outline drawing see page 9

**Contact specification**

Contact configuration		1 CO (SPDT)
Rated current/Maximum peak current	A	10/15
Rated voltage/Maximum switching voltage	V AC	250/400
Rated load AC1	VA	2500
Rated load AC15 (230 V AC)	VA	500
Single phase motor rating (230 V AC)	kW	0.44
Breaking capacity DC1 (24/110/220 V)	A	10/0.3/0.12
Minimum switching load	mW (V/mA)	300 (5/5)
Standard contact material		AgSnO <sub>2</sub>

**Feedback contact specification (terminals B1-B2)**

Contact configuration		1 NO (SPST-NO)
Maximum current	mA	300
Rated voltage	V AC/DC	24

**Supply & Input specification**

Nominal voltage (U <sub>N</sub> )	V AC (50/60 Hz)	24
	V DC	24
Rated power	VA (50 Hz)/W	0.6/0.4
Operating range	AC	(0.8...1.1)U <sub>N</sub>
	DC	(0.8...1.1)U <sub>N</sub>

**Technical data**

Ambient temperature range	°C	-20...+50
Protection category		IP 20

**Approvals (according to type)**

19.21.0.024.0000



- 1 CO output contact
- 11.2 mm wide
- Feedback contact

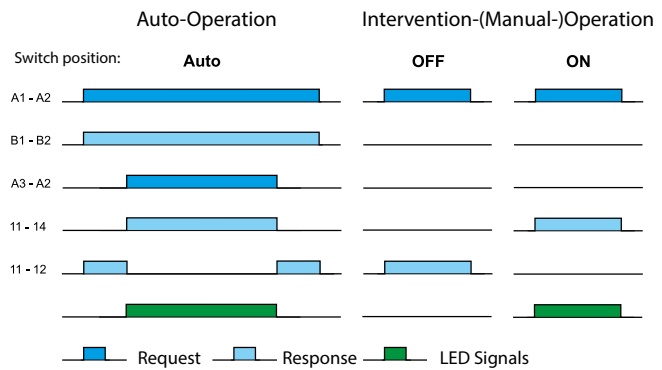

B1-B2 feedback to the controller signaling Auto-operation  
A3-A2 "Auto" signal from Controller

B

**Analogue override module - Auto/Hand (0...10)V**

- Analogue output module intended to provide, by the selection switch on the front panel, a (0...10)V output, automatically or by hand.
- With the selector switch in position "A" (Automatic) the (0...10)V signal is derived from the controller.
- In position "H" (Hand) the controller signal is ignored and the (0...10)V signal is derived directly from the potentiometer setting on the fascia of the module
- The level of the (0...10)V output signal is displayed by 3 green LEDs, set at > 25%, > 50% and > 75%.
- 24 V AC/DC supply
- 35 mm rail (EN 60715) mounting

**Application examples:**

- permits the direct control of proportional valves under exceptional circumstances or where the automatic controller has failed

**Wiring diagram**

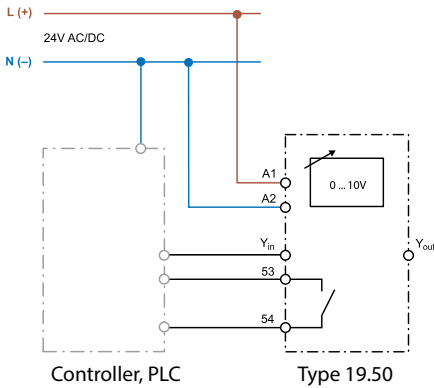

**19.50.0.024.0000**



- Analogue output (0...10)V, plus 1 feedback output contact
- 17.5 mm wide
- LED indicator

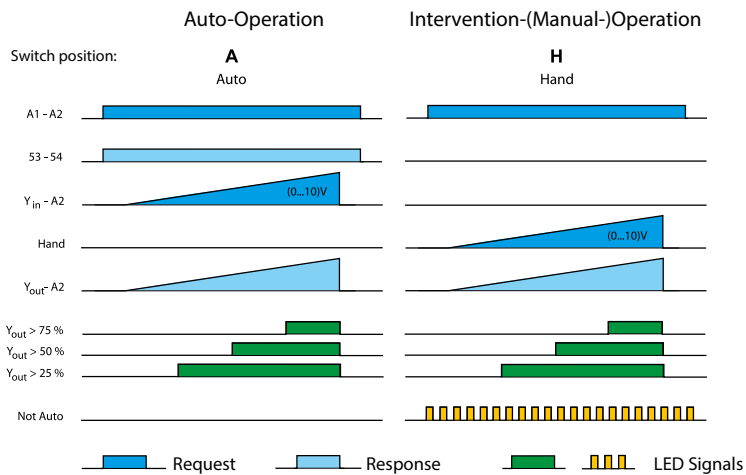

53-54 feedback to the controller signaling Auto-operation  
 Yin-A2 variable (0...10)V DC from the controller  
 Hand (0...10)V DC value set by the potentiometer

For outline drawing see page 9

**(0...10)V Signal specification** (terminal Y<sub>in</sub>)

Input control signal	V DC	0...10 (I <sub>max</sub> 20 mA - short-circuit protected)
Green LED 25%		> 2.5 V
Green LED 50%		> 5 V
Green LED 75%		> 7.5 V

**Feedback output specification** (terminals 53-54)

Output configuration		1 NO (SPST-NO)
Maximum / Minimum current	mA	100/10
Rated voltage	V AC/DC	24

**Supply & Input specification**

Nominal voltage (U <sub>N</sub> )	V AC (50/60 Hz)	24
	V DC	24
Rated power AC/DC	VA (50 Hz)/W	0.9/0.7
Operating range	AC	(0.8...1.1)U <sub>N</sub>
	DC	(0.8...1.1)U <sub>N</sub>

**Technical data**

Ambient temperature range	°C	-20...+50
Protection category		IP 20

**Approvals** (according to type)





**Power relay module 16 A**

- Suitable for Lamps load
- AgSnO<sub>2</sub> contacts for heavy duty, high inrush current loads
- DC supply (12 or 24 V)
- LED indicator
- Reinforced insulation between supply and contacts
- Cadmium Free contacts
- 35 mm rail (EN 60715) mounting

**Wiring diagram**

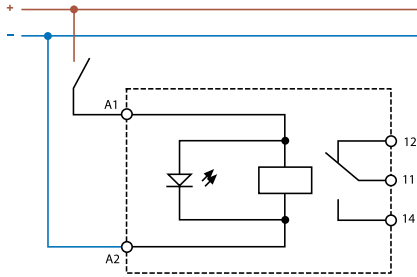

For outline drawing see page 9

**Contact specification**

Contact configuration		1 CO (SPDT)
Rated current/Maximum peak current	A	16/30 (120 A - 5 ms)
Rated voltage/ Maximum switching voltage	V AC	250/440
Rated load AC1	VA	4000
Rated load AC15 (230 V AC)	VA	750
Nominal lamp rating (230 V):		
incandescent/halogen W		2000
fluorescent tubes with electronic ballast W		1000
fluorescent tubes with electromagnetic ballast W		750
CFL W		400
230 V LED W		400
halogen or LED with electronic ballast W		400
halogen or LED with electromagnetic ballast W		800
Minimum switching load	mW	300 (5 V/ 5 mA)
Standard contact material		AgSnO <sub>2</sub>

**Coil specification**

Nominal voltage (U <sub>N</sub> )	VDC	12 - 24
Rated power DC	W	0.5
Operating range		(0.8 ... 1.1)U <sub>N</sub>

**Technical data**

Mechanical life AC/DC	cycles	10 · 10 <sup>6</sup>
Electrical life at rated load AC1	cycles	80 · 10 <sup>3</sup>
Operate/release time	ms	12/8
Ambient temperature range	°C	-20...+50
Protection category		IP 20

**Approvals** (according to type)



**19.91.9.0xx.4000**



- 1 Pole changeover contact
- 17.5 mm

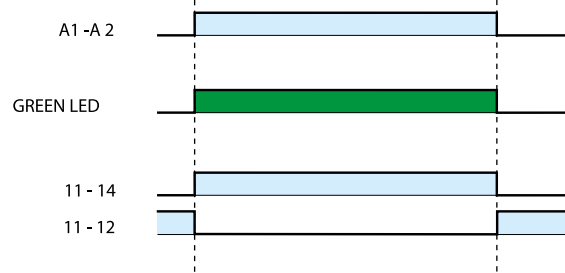

**Switching actuator with KNX technology - 16 A****Compact and powerful switching actuator with 6 relay outputs**

- 6 output contacts rated 16 A 250 V AC, individually configurable NO or NC
- LED status indicator for each output
- Time functions (ON, OFF, Blink, Staircase)
- Independent logic and analog functions for each output (AND, OR, XOR, THRESHOLD, WINDOW)
- Scenario Management
- Output control area for manual control
- Supply voltage via KNX bus
- 35 mm rail (EN 60715) mounting

19.6K  
Screw terminal



For outline drawing see page 9

**Contact specification**

Contact configuration (via ETS)	V AC	NO - NC
Rated current/Maximum peak current	A	16/120 (5 ms)
Rated voltage/ Maximum switching voltage	V	250/400
Rated load AC1	VA	4000
Rated load AC15 (230 V AC)	VA	750
Single phase motor rating (230 V AC)	kW	0.55
Nominal lamp rating (230 V):		
incandescent/halogen W		2000
fluorescent lamp with electronic ballast W		1000
fluorescent lamp with electromagnetic ballast W		750
CFL W		400
LED 230 V W		400
halogen or LV LED with electronic ballast W		400
halogen or LV LED with electromagnetic ballast W		800
Standard contact material		AgSnO <sub>2</sub>

**Supply specification**

Type of BUS		KNX
Supply voltage	VDC	30
Nominal consumption	mA	15

**Technical data**

Mechanical life	cycles	10 · 10 <sup>6</sup>
Electrical life at rated load AC1	cycles	100 · 10 <sup>3</sup>
Ambient temperature range	°C	-5...+45
Protection category		IP 20

**Approvals (according to type)**

**NEW** 19.6K.9.030.4300

KNX



- Bistable relay ENEC approved (Maximum peak current up to 120 A)
- Suitable for lamp loads

## Ordering information

Example: 19 series Auto/Off/On override module, 1 CO (SPDT) 10 A contact, 24 V AC/DC supply.



**Series**

**Type**

- 21 = Auto/Off/On output module, 11.2 mm
- 50 = Analogue override module (0...10)V
- 91 = Power relay module
- 6K = KNX actuator, 6 poles 16 A

**Supply version**

- 0 = AC (50/60 Hz)/DC
- 9 = DC

**Supply voltage**

- 012 = 12 V
- 024 = 24 V
- 030 = KNX Bus

**Contact circuit**

- 0 = Standard
- 3 = NO (19.6K)

**Contact material**

- 0 = Standard for 19.21, 19.50
- 4 = Standard for 19.91, 19.6K

**Codes / Module width**

- 19.21.0.024.0000/11.2 mm
- 19.50.0.024.0000/17.5 mm
- 19.91.9.012.4000/17.5 mm
- 19.91.9.024.4000/17.5 mm
- 19.6K.9.030.4300/70 mm

## Technical data

Insulation		19.21	19.50	19.91	
Dielectric strength (V AC)	between supply and contacts	3000	—	4000	
	between open contacts	1000	—	1000	
	between supply and feedback output	2000	1500	—	
EMC specifications					
Type of test		Reference standard	19.21/91	19.50	
Electrostatic discharge	contact discharge	EN 61000-4-2	4 kV		
	air discharge	EN 61000-4-2	8 kV		
Radiated electromagnetic field (80...1000 MHz)		EN 61000-4-3	30 V/m		
Fast transients (burst) (5-50 ns, 5 kHz)		EN 61000-4-4	4 kV		
Voltage pulses (1.2/50 µs)	common mode	EN 61000-4-5	2 kV	1 kV	
	on supply terminals	EN 61000-4-5	1 kV	0.5 kV	
Terminals		19.21/6K		19.50/91	
Screw torque	Nm	0.5		0.8	
		solid cable	stranded cable	solid cable	stranded cable
		mm <sup>2</sup>	1 x 6 / 2 x 2.5	1 x 4 / 2 x 1.5	1 x 6 / 2 x 4
	AWG	1 x 10 / 2 x 14	1 x 12 / 2 x 16	1 x 10 / 2 x 12	1 x 12 / 2 x 14
Wire strip length	mm	7		9	

Wiring diagrams - Application examples

Type 19.21

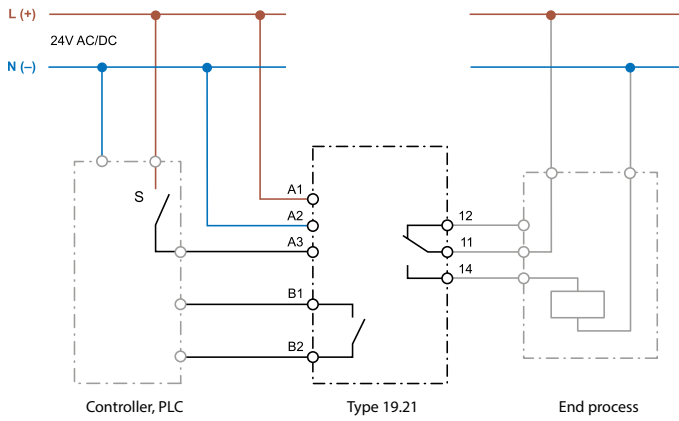

B

Type 19.50

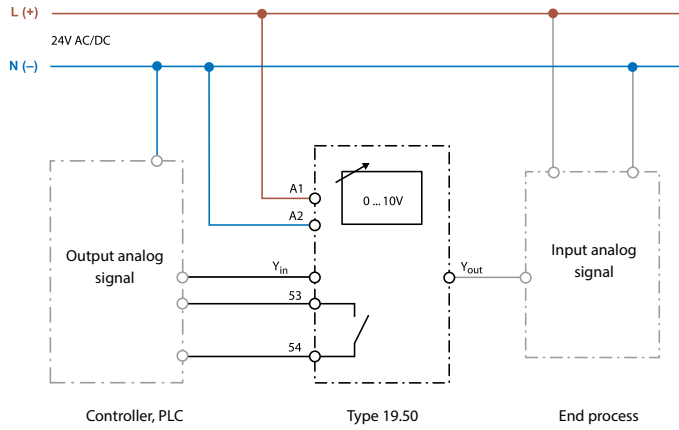

In selector position A (Automatic) the (0...10)V controller variable is transferred via  $Y_{in}$  - A2 and  $Y_{out}$  to the end process.  
In selector position H (Hand) the (0...10)V value set by the regulator is transferred via  $Y_{out}$  to the end process.

Type 19.6K

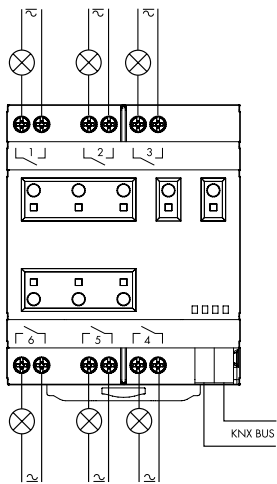

Outline drawings

Type 19.21  
Screw terminal

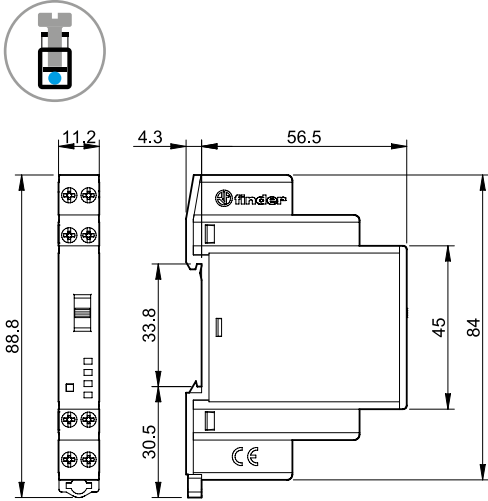

Type 19.50  
Screw terminal

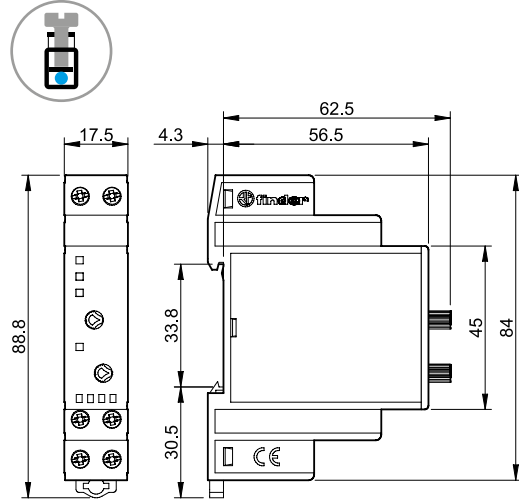

Type 19.91  
Screw terminal

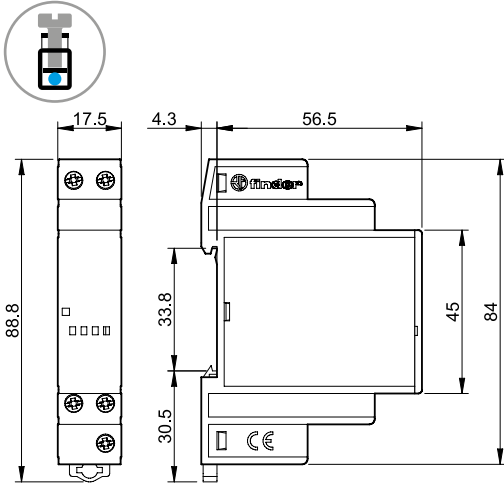

Type 19.6K  
Screw terminal

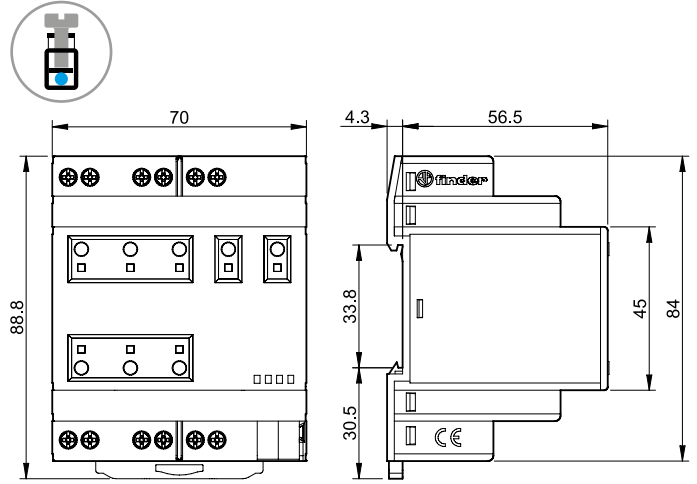

B

## Accessories

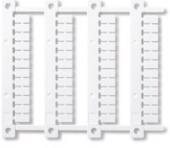

060.48

<b>Sheet of marker tags (CEMBRE Thermal transfer printers)</b> for 19.21/50/91/6K types, (48 tags) 6 x 12 mm	060.48
--	--------

B



019.01

<b>Identification tag</b> , for 19.50 types, plastic, 1 tag, 17 x 25.5 mm	019.01
---	--------



020.01

<b>Adaptor for panel mounting</b> , for 19.21/50/91 types, plastic, 17.5 mm wide	020.01
--	--------

## Application notes

### Intervention Modules

The demand for security apparatus, heating, air conditioning or efficient energy use in offices, hotels, and private homes or in industrial space is growing constantly, leading to the installation of increasingly complex electronic systems. But what happens if these systems malfunction and a qualified service technician will only be available in a few hours, or even days?

With the use of carefully installed intervention modules, a trained caretaker or security guard can be in a position to recognize interruptions in service, and by manual intervention perform the necessary override actions to maintain system operation until a repair can be effected.

### Digital Override control module

#### Auto-Off-On output module (Type 19.21)

Many processes or systems are automatically controlled by an electronic control system or by a Programmable Logic Controller.

In the event of an electronic system malfunction it is important, in order to avoid damage or downtime, to plan for the possibility of controlling the process manually. An Auto-Off-On Module can provide this, located between the output of the electronic system (Controller) and the process to be controlled (End Process) - bypassing the malfunctioning control unit in a planned way. For malfunctioning electronic systems, the process to be controlled can be manually switched On or Off, as needed, using the switch on the front of the unit. Under healthy functioning of the electronic system, the switch is left in the Auto position. In this configuration the process is controlled by the normal functioning of the electronic system and its output. It may be important to know (remotely) if the process is being controlled manually or automatically, in which case the feedback contact on the Auto-Off-On module 19.21 can provide this.

### Analogue Override control module

#### Analogue output module (0...10)V (Type 19.50)

This module can be installed where there is need to give a manually adjustable analog signal (0...10)V priority over an analog signal from a electronic control unit or PLC, or to override and replace a malfunctioning signal.

The Analogue override module provides, by the selection switch on the front panel, a (0...10)V output signal either generated automatically or by hand. With the selector switch in position "A" (Automatic) the (0...10)V signal at  $Y_{out-A2}$  is derived from the controller signal applied to terminals  $Y_{in-A2}$ . In position "H" (Hand) the controller signal is ignored and the (0...10)V signal is derived directly from the potentiometer setting on the module front panel.

Operation in switch position H is indicated by a blinking yellow LED, and by the opening of contact 51-52 – which could be used to report the override condition to the central control room.

The level of the (0...10)V output signal is displayed by 3 green LEDs, set at > 25%, > 50% and > 75%





# PCB Relay with forcibly guided contacts 8 A



Hoists and cranes



Escalators



Medical and dentistry



Hospitals



Carousel warehouses



Elevators and lifts



Disabled lift



Wood-processing machines

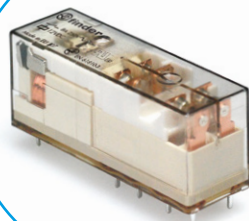



**PCB Relay with forcibly guided contacts according to EN 61810-3 (previously EN 50205)**

**Type B  
2 CO contacts\***

- Type 50.12...x000**  
- 2 pole 8 A  
- Contact AgNi, AgSnO<sub>2</sub>

- Type 50.12...5000**  
- 2 pole 8 A  
- Contact AgNi + Au

- High physical separation between adjacent contacts
- Cadmium Free contact materials
- 8 mm, 6 kV (1.2/50 μs) isolation, coil-contacts
- Flux proof: RT II

**50.12...x000**



- For medium duty switching, suggested for DC loads
- 2 pole 8 A
- 5 mm pinning
- PCB mounting

**50.12...5000**



- For safety applications
- Gold plate contacts for low level switching capability
- 5 mm pinning
- PCB mounting

\* According to EN 61810-3 only 1 NO and 1 NC (11-14 and 21-22 or 11-12 and 21-24) shall be used as forcibly guided contacts.

For UL RATINGS SEE:  
"General technical information" page V

For outline drawing see page 7

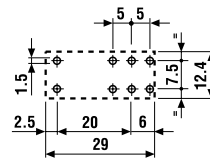
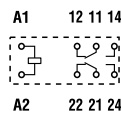

Copper side view

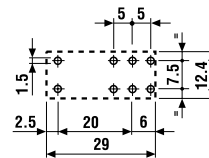
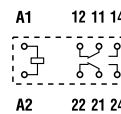

Copper side view

**Contact specification**

Contact configuration		2 CO (DPDT)	2 CO (DPDT)
Rated current/Maximum peak current	A	8/15	8/15
Rated voltage/ Maximum switching voltage	V AC	250/400	250/400
Rated load AC1	VA	2000	2000
Rated load AC15 (230 V AC)	VA	500	500
Single phase motor rating (230 V AC)	kW	0.37	0.37
Breaking capacity DC1: 24/110/220 V	A	8/0.65/0.2	8/0.65/0.2
Minimum switching load	mW (V/mA)	500 (10/10)	50 (5/5)
Standard contact material		AgNi, AgSnO <sub>2</sub>	AgNi + Au

**Coil specification**

Nominal voltage (U <sub>N</sub> )	V AC (50/60 Hz)	—	—
	V DC	5 - 6 - 12 - 24 - 48 - 60 - 110 - 125	5 - 6 - 12 - 24 - 48 - 60 - 110 - 125
Rated power AC/DC	VA (50 Hz)/W	—/0.7	—/0.7
Operating range	AC (50 Hz)	—	—
	DC	(0.75...1.2)U <sub>N</sub>	(0.75...1.2)U <sub>N</sub>
Holding voltage	AC/DC	—/0.4 U <sub>N</sub>	—/0.4 U <sub>N</sub>
Must drop-out voltage	AC/DC	—/0.1 U <sub>N</sub>	—/0.1 U <sub>N</sub>

**Technical data**

Mechanical life AC/DC	cycles	—/10 · 10 <sup>6</sup>	—/10 · 10 <sup>6</sup>
Electrical life at rated load AC1	cycles	100 · 10 <sup>3</sup>	100 · 10 <sup>3</sup>
Operate/release time	ms	10/4	10/4
Insulation between coil and contacts (1.2/50 μs)	kV	6 (8 mm)	6 (8 mm)
Dielectric strength between open contacts	V AC	1500	1500
Ambient temperature range	°C	−40...+70	−40...+70
Environmental protection		RT II	RT II

**Approvals** (according to type)



**PCB Relay with forcibly guided contacts according to EN 61810 (previously EN 50205) Type A**

**Type 50.14...4220/4310**

- 4 pole 8 A (2 NO + 2 NC) or (3 NO + 1 NC)
- Contact AgSnO<sub>2</sub>

**Type 50.16...5420/5510/5330**

- 6 pole 8 A (4 NO + 2 NC) or (5 NO + 1 NC) or (3 NO + 3 NC)
- Contact AgSnO<sub>2</sub> + Au

- High physical separation between adjacent contacts
- Cadmium Free contact materials
- DC coil 800 mW
- 8 mm, 6 kV (1.2/50 μs) isolation, coil-contacts
- PCB mounting
- Wash tight: RT III

**NEW 50.14**



- For safety applications
- 4 pole 8 A
- PCB mounting

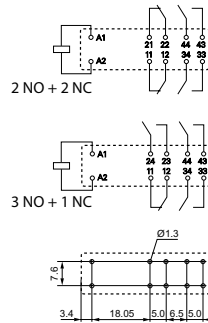

Copper side view

**NEW 50.16**



- For safety applications
- 6 pole 8 A
- PCB mounting

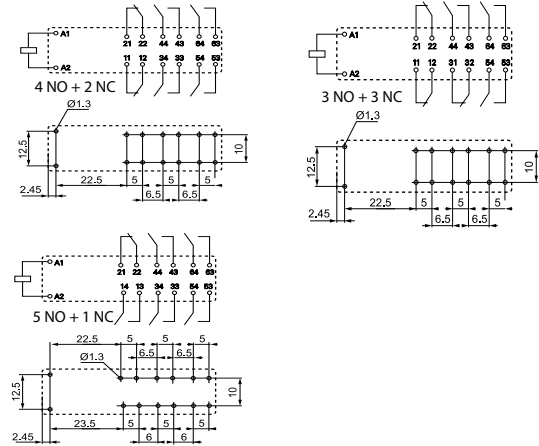

Copper side view

FOR UL RATINGS SEE:

"General technical information" page V

For outline drawing see page 7

**Contact specification**

Contact configuration		2 NO + 2 NC, 3 NO + 1 NC	4 NO + 2 NC, 5 NO + 1 NC, 3 NO + 3 NC
Rated current/Maximum peak current	A	8/15	8/15
Rated voltage/ Maximum switching voltage	V AC	250/400	250/400
Rated load AC1	VA	2000	2000
Rated load AC15 (230 V AC)	VA	700	1100
Single phase motor rating (230 V AC)	kW	0.37	0.37
Breaking capacity DC1: 24/110/220 V	A	8/0.6/0.2	8/0.6/0.2
Minimum switching load	mW (V/mA)	50 (5/10)	50 (5/10)
Standard contact material		AgSnO <sub>2</sub>	AgSnO <sub>2</sub> + Au

**Coil specification**

Nominal voltage (U <sub>N</sub> )	V AC (50/60 Hz)	—	—
	V DC	12 - 24 - 48 - 110	12 - 24 - 48 - 110
Rated power AC/DC	VA (50 Hz)/W	—/0.8	—/0.8
Operating range	AC (50 Hz)	—	—
	DC	(0.75...1.2)U <sub>N</sub>	(0.75...1.2)U <sub>N</sub>
Holding voltage	AC/DC	—/0.4 U <sub>N</sub>	—/0.4 U <sub>N</sub>
Must drop-out voltage	AC/DC	—/0.1 U <sub>N</sub>	—/0.1 U <sub>N</sub>

**Technical data**

Mechanical life AC/DC	cycles	—/10 · 10 <sup>6</sup>	—/10 · 10 <sup>6</sup>
Electrical life at rated load AC1	cycles	100 · 10 <sup>3</sup>	100 · 10 <sup>3</sup>
Operate/release time	ms	10/4	10/4
Insulation between coil and contacts (1.2/50 μs)	kV	6 (8 mm)	6 (8 mm)
Dielectric strength between open contacts	V AC	1500	1500
Ambient temperature range	°C	-40...+70	-40...+70
Environmental protection		RT III	RT III

**Approvals** (according to type)



## Ordering information

Example: 50 series forcibly guided contacts, 2 CO (DPDT) 8 A contacts, 24 V DC coil.

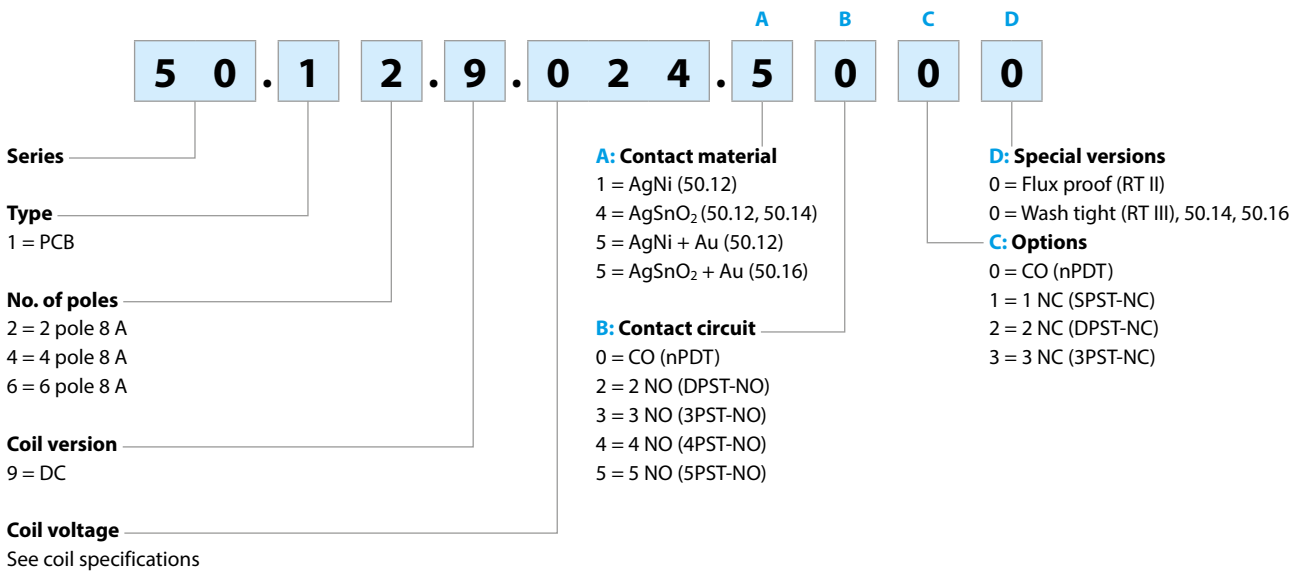

## Technical data

Insulation according to EN 61810-1			
Nominal voltage of supply system	V AC	230/400	
Rated insulation voltage	V AC	250	400
Pollution degree		3	2
Insulation between coil and contact set			
Type of insulation		Reinforced (8 mm)	
Overvoltage category		III	
Rated impulse voltage	kV (1.2/50 µs)	6	
Dielectric strength	V AC	4000	
Insulation between adjacent contacts			
Type of insulation		Basic	
Overvoltage category		III	
Rated impulse voltage	kV (1.2/50 µs)	4	
Dielectric strength (50.12, 50.16)	V AC	3000	
Dielectric strength (50.14)	V AC	2500	
Insulation between open contacts			
Type of disconnection		Micro-disconnection	
Dielectric strength	V AC/kV (1.2/50 µs)	1500/2.5	
Insulation between coil terminals			
Rated impulse voltage (surge) differential mode (according to EN 61000-4-5)	kV (1.2/50 µs)	2	
Other data			
Bounce time: NO/NC	ms	2/10	
Vibration resistance (10...200)Hz: NO/NC	g	20/6	
Shock resistance NO/NC	g	20/5	
Power lost to the environment	without contact current	W	0.7
	with rated current	W	1.2
Recommended distance between relays mounted on PCB	mm	≥ 5	

### Contact specification

F 50 - Electrical life (AC) v contact current (type 50.12)

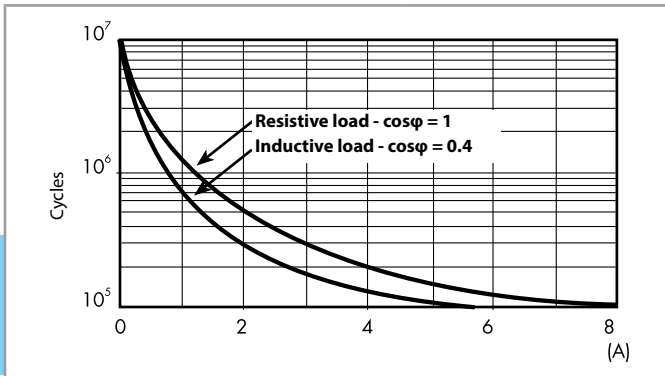

H 50 - Maximum DC1 breaking capacity (type 50.12)

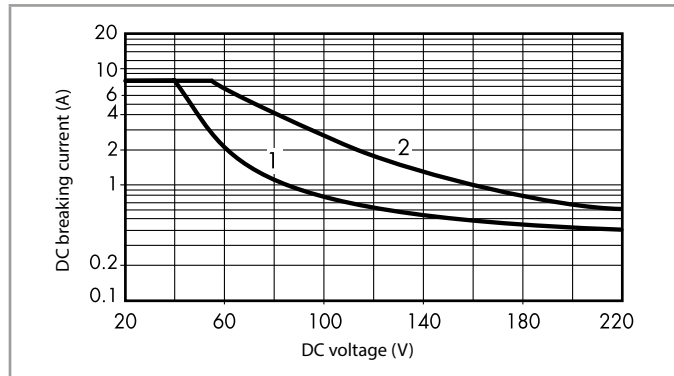

- When switching a resistive load (DC1) having voltage and current values under the curve, an electrical life of  $\geq 100 \cdot 10^3$  can be expected.
- In the case of DC13 loads, the connection of a diode in parallel with the load will permit a similar electrical life as for a DC1 load.  
Note: the release time for the load will be increased.

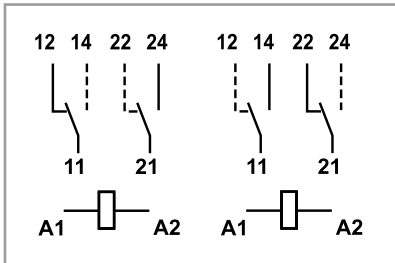

Alternative selection of NO and NC contacts to provide Forcibly guided (mechanically linked) contacts, in accordance with EN 61810-3 (type B).

### Coil specifications

DC coil data (type 50.12)

Nominal voltage $U_N$ V	Coil code	Operating range		Resistance R $\Omega$	Rated coil consumption I at $U_N$ mA
		$U_{min}$ V	$U_{max}$ V		
5	9.005	3.8	6	35	143
6	9.006	4.5	7.2	50	120
12	9.012	9	14.4	205	58.5
24	9.024	18	28.8	820	29.3
48	9.048	36	57.6	3280	14.4
60	9.060	45	72	5140	11.7
110	9.110	82.5	131	17250	6.4
125	9.125	93.7	150	22300	5.6

R 50 - DC coil operating range v ambient temperature  
Standard coil (type 50.12)

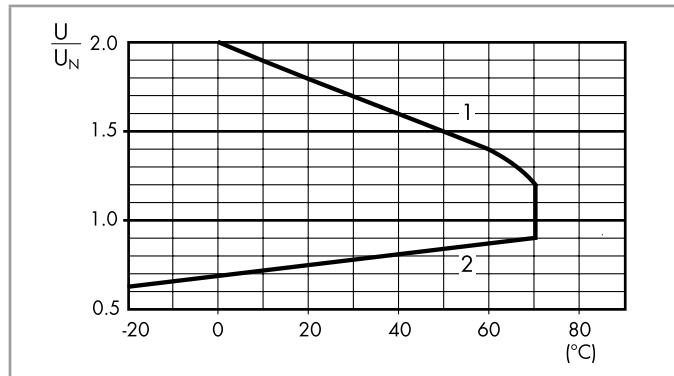

- 1 - Max. permitted coil voltage.
- 2 - Min. pick-up voltage with coil at ambient temperature.

DC coil data (type 50.14/16)

Nominal voltage $U_N$ V	Coil code	Operating range		Resistance R $\Omega$	Rated coil consumption I at $U_N$ mA
		$U_{min}$ V	$U_{max}$ V		
12	9.012	9	14.4	180	66.6
24	9.024	18	28.8	720	33.3
48	9.048	36	57.6	2880	16.6
110	9.110	82.5	131	15125	7.7

## Contact specification

F 50 - Electrical life (AC) v contact current (type 50.14)

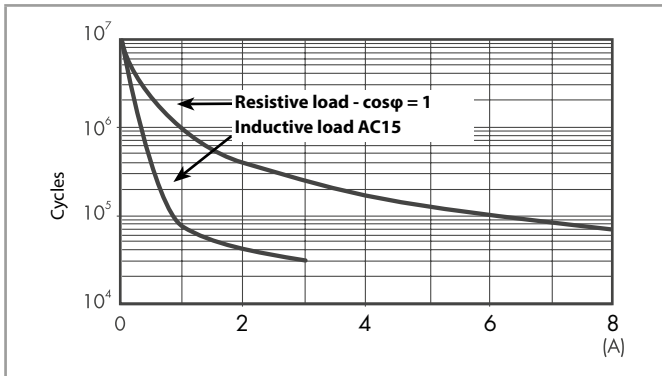

H 50 - Maximum DC1 breaking capacity (type 50.14)

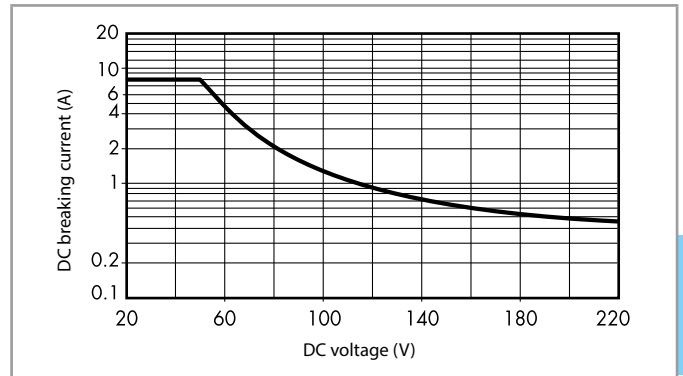

- When switching a resistive load (DC1) having voltage and current values under the curve, an electrical life of  $\geq 100 \cdot 10^3$  can be expected.
- In the case of DC13 loads, the connection of a diode in parallel with the load will permit a similar electrical life as for a DC1 load.  
Note: the release time for the load will be increased.

F 50 - Electrical life (AC) v contact current (type 50.16)

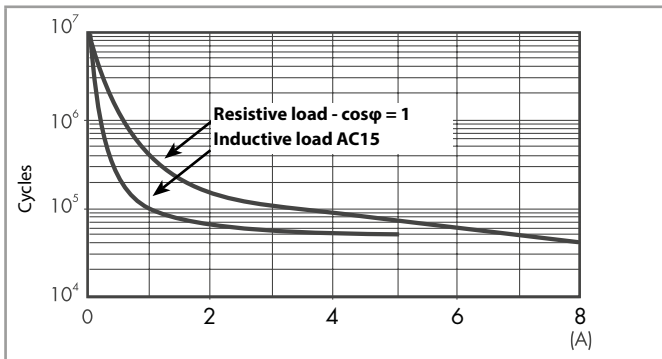

H 50 - Maximum DC1 breaking capacity (type 50.16)

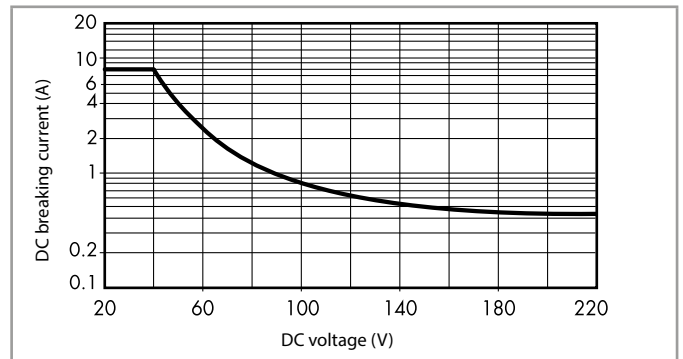

- When switching a resistive load (DC1) having voltage and current values under the curve, an electrical life of  $\geq 100 \cdot 10^3$  can be expected.
- In the case of DC13 loads, the connection of a diode in parallel with the load will permit a similar electrical life as for a DC1 load.  
Note: the release time for the load will be increased.

## Outline drawings

Types 50.12...x000/50.12...5000

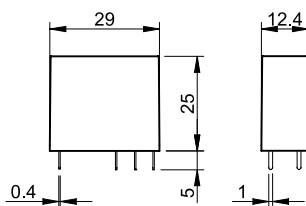

Type 50.14

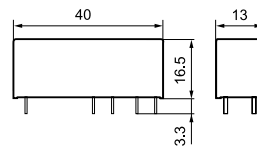

Type 50.16

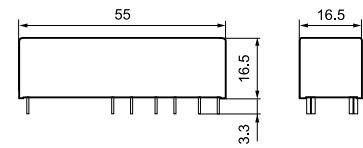





# Modular relays with forcibly guided contacts 6 - 10 A



Chemical and  
petrochemical



Hoists and cranes



Wood-  
processing  
machines



Carousel  
warehouses



Escalators



Elevators  
and lifts



Process  
Industry



Automatic  
car-washes





**Modular relays with forcibly guided contacts**

**Type 7S.12/32**

- 2 pole 6 A (1 NO + 1 NC)

**Type 7S.14/34**

- 4 pole 6 A (2 NO + 2 NC and 3 NO + 1 NC)

**Type 7S.16/36**

- 6 pole 6 A (4 NO + 2 NC and 5 NO + 1 NC)

- For safety applications, with class A forcibly guided contact relays EN 61810-3 (previously EN 50205)
- SIL2 evaluated according to EN 61508, for use in functional safety application according to EN 62061 up to SIL2 and according to IEC 13849-1 up to PL d (instead of For functional reliability in machinery and plant engineering according to EN 13849-1)
- For functional reliability in machinery and plant engineering according to EN 13849-1
- Railways application versions available
- DC and AC supply versions
- Coil status visual indication with LED
- 35 mm rail (EN 60715) mount

**7S.12/32...5110**



- 2 pole (1 NO + 1 NC)

**7S.14/34...4xx0**



- 4 pole :  
(2 NO + 2 NC) type 7S.xx.x.xxx.4220  
(3 NO + 1 NC) type 7S.xx.x.xxx.4310

**7S.16/36...5xx0**



- 6 pole:  
(4 NO + 2 NC) type 7S.xx.x.xxx.5420  
(5 NO + 1 NC) type 7S.xx.x.xxx.5510

Screwless terminal



Screw terminal



For outline drawing see page 12

**Contact specification**

Contact configuration		1 NO + 1 NC	2 NO + 2 NC, 3 NO + 1 NC	4 NO + 2 NC, 5 NO + 1 NC
Rated current/Max. peak current	A	6/15	6/15	6/15
Rated switching voltage	V AC (50/60 Hz)	250	250	250
Rated load AC1	VA	1500	1500	1500
Rated current AC15 (230 V AC)	A	5	5	5
Rated current AC15 (400 V AC)	A	2	—	—
Breaking capacity DC1: 24/110/220 V	A	6/0.6/0.2	6/0.9/0.3	6/0.9/0.3
Breaking capacity DC13: 24 V	A	1	3	3
Minimum switching load	mW (V/mA)	60 (5/5)	60 (5/10)	60 (5/10)
Standard contact material		AgNi + Au	AgSnO <sub>2</sub>	AgSnO <sub>2</sub> +Au

**Coil specification**

Nominal voltage (U <sub>N</sub> )	V AC (50/60 Hz)	110...125 - 230...240	110...125 - 230...240	110...125 - 230...240
	V DC	12 - 24	12 - 24 - 110	12 - 24 - 110
Rated power	VA (50 Hz)/W	2.3/1	2.3/1	2.3/1
Operating range	AC	(0.85...1.1)U <sub>N</sub>	(0.85...1.1)U <sub>N</sub>	(0.85...1.1)U <sub>N</sub>
	DC	(0.8...1.2)U <sub>N</sub>	(0.8...1.2)U <sub>N</sub>	(0.8...1.2)U <sub>N</sub>
	DC (24 and 110 V only)	(0.7...1.25)U <sub>N</sub>	(0.7...1.25)U <sub>N</sub>	(0.7...1.25)U <sub>N</sub>
Holding voltage	AC/DC	0.45 U <sub>N</sub> / 0.45 U <sub>N</sub>	0.55 U <sub>N</sub> / 0.55 U <sub>N</sub>	0.55 U <sub>N</sub> / 0.55 U <sub>N</sub>
Must drop-out voltage	AC/DC	0.1 U <sub>N</sub> / 0.1 U <sub>N</sub>	0.1 U <sub>N</sub> / 0.1 U <sub>N</sub>	0.1 U <sub>N</sub> / 0.1 U <sub>N</sub>

**Technical data**

Mechanical life	cycles	10 · 10 <sup>6</sup>	10 · 10 <sup>6</sup>	10 · 10 <sup>6</sup>
Electrical life at rated load AC1	cycles	100 · 10 <sup>3</sup>	100 · 10 <sup>3</sup>	100 · 10 <sup>3</sup>
Operate/release time	ms	7/11	12/10	12/10
Insulation between coil and contacts (1.2/50 μs)	kV	6	6	6
Dielectric strength between open contacts	V AC	1500	1500	1500
Ambient temperature	°C	-40...+70	-40...+70	-40...+70
Protection category		IP 20	IP 20	IP 20

**Approvals** (according to type)



**Modular relays with forcibly guided contacts**
**Type 7S.23**

- 3 pole (2 NO + 1 NC)





- For safety applications, with class A forcibly guided contact relays EN 61810-3 (previously EN 50205)
- SIL2 evaluated according to EN 61508, for use in functional safety application according to EN 62061 up to SIL2 and according to IEC 13849-1 up to PL d (instead of For functional reliability in machinery and plant engineering according to EN 13849-1)
- For functional reliability in machinery and plant engineering according to EN 13849-1
- DC coil
- Cadmium free contacts
- 17.5 mm wide
- Coil status visual indication with LED
- 35 mm rail (EN 60715) mount

Screw terminal

**7S.23**

- 3 pole (2 NO + 1 NC)

For outline drawing see page 12

Contact specification		
Contact configuration		2 NO + 1 NC
Rated current/Max. peak current	A	10/20
Rated switching voltage	V AC (50/60 Hz)	250
Rated load AC1	VA	2500
Rated current AC15 (230 V AC)	A	5
Breaking capacity DC1: 24/110/220 V	A	10/0.6/0.3
Breaking capacity DC13: 24 V	A	5
Minimum switching load	mW (V/mA)	60 (5/5)
Standard contact material		AgNi + Au
Coil specification		
Nominal voltage (U <sub>N</sub> )	V DC	12 - 24 - 48 - 110
Rated power	W	1
Operating range	DC	(0.8...1.2)U <sub>N</sub>
Holding voltage	DC	0.45 U <sub>N</sub>
Must drop-out voltage	DC	0.1 U <sub>N</sub>
Technical data		
Mechanical life	cycles	10 · 10 <sup>6</sup>
Electrical life at rated load AC1	cycles	100 · 10 <sup>3</sup>
Operate/release time	ms	7/11
Insulation between coil and contacts (1.2/50 μs)	kV	6
Dielectric strength between open contacts	V AC	1500
Ambient temperature	°C	-40...+70
Protection category		IP 20
<b>Approvals</b> (according to type)		    

**Modular relays with forcibly guided contacts for SIL3 safety applications**

**Type 7S.43/63**

- 2 NO safety contacts
- 1 NC feedback contact
- 1 auxiliary signalling contact
- For safety application, with class A forcibly guided contact relays EN 61810-3 (previously EN 50205) for safety application up to SIL 3
- SIL 3 evaluated according to EN 61508, for use in functional safety application according to EN 62061 up to SIL 3 and according to IEC 13849-1 up to PL e
- Double channel architecture (1oo2) with 2 NO contact, 1 feedback contact and 1 auxiliary contact
- From 12 up to 110 V DC version with operating range  $(0.85 \dots 1.1)U_N$
- DC coil
- Coil status visual indication with LED
- 35 mm rail (EN 60715) mount

Screwless terminal

Screw terminal



For outline drawing see page 12

**7S.43/63...0211**



- 3 pole (2 NO + 1 NC)
- 1 auxiliary contact

Contact specification		
Contact configuration		2 NO + 1 NC + 1 AUX
Rated current/Max. peak current	A	6/15
Rated switching voltage	V AC (50/60 Hz)	250
Rated load AC1	VA	1500
Rated current AC15 (230 V AC)	A	5
Breaking capacity DC1: 24/110/220 V	A	6/0.6/0.2
Breaking capacity DC13: 24 V	A	3
Minimum switching load	mW (V/mA)	60 (5/10)
Standard contact material		AgSnO <sub>2</sub> & AgNi+Au
Coil specification		
Nominal voltage (U <sub>N</sub> )	V DC	12 - 24 - 48 - 110
Rated power	W	1.7
Operating range	DC	$(0.85 \dots 1.1)U_N$
Holding voltage	DC	0.55 U <sub>N</sub>
Must drop-out voltage	DC	0.1 U <sub>N</sub>
Technical data		
Mechanical life	cycles	10 · 10 <sup>6</sup>
Electrical life at rated load AC1	cycles	100 · 10 <sup>3</sup>
Operate/release time of NO contacts	ms	10/7
Operate/release time of NC contacts	ms	5/30
Insulation between coil and contacts (1.2/50 μs)	kV	6
Dielectric strength between open contacts	V AC	1500
Ambient temperature	°C	-40...+70
Protection category		IP 20
<b>Approvals</b> (according to type)		<b>CE</b> <b>UK</b> <b>EAC</b> <b>SIL3</b> <b>eU</b> <b>US</b>

## Ordering information

Example: 7S series Modular relay with forcibly guided contacts, 6 contact (4 NO + 2 NC) 6 A, supply voltage 24 V DC.

**7 S . 1 6 . 9 . 0 2 4 . 5 4 2 0**

**Series**

**Type**

- 1 = 22.5 mm wide, screwless terminals
- 2 = 17.5 mm wide, screw terminals
- 3 = 22.5 mm wide, screw terminals
- 4 = 22.5 mm wide, screwless terminals
- 6 = 22.5 mm wide, screw terminals

**Output**

- 2 = 2 contacts
- 3 = 3 contacts
- 4 = 4 contacts
- 6 = 6 contacts

**Supply version**

- 8 = AC (50 /60 Hz)
- 9 = DC

**Supply voltage**

See page 10

T= Railways application version

**Special versions**

- 0 = Standard
- 1 = NO auxiliary contact

**NO and NC contacts**

- 11 = 1 NO + 1 NC (SPST-NO + SPST-NC)
- 21 = 2 NO + 1 NC (DPST-NO+SPST-NC)
- 22 = 2 NO + 2 NC (DPST-NO + DPST-NC)
- 31 = 3 NO + 1 NC (3PST-NO + SPST-NC)
- 42 = 4 NO + 2 NC (4PST-NO + DPST-NC)
- 51 = 5 NO + 1 NC (4PST-NO + SPST-NC)

**Contact material**

- 0 = AgNi +Au (7S.23) only
- 0 = AgSnO<sub>2</sub> & AgNi + Au (7S.43/63) only
- 4 = AgSnO<sub>2</sub> (7S.14/34) only
- 5 = AgNi +Au (7S.12/32) only
- 5 = AgSnO<sub>2</sub> + Au (7S.16/36) only

**Codes, Preferred selections for best availability are shown in bold.**

7S.12.9.012.5110	7S.14.9.012.4220	7S.16.9.012.5420
<b>7S.12.9.024.5110</b>	7S.14.9.012.4310	<b>7S.16.9.024.5420</b>
7S.12.8.120.5110	<b>7S.14.9.024.4220</b>	<b>7S.16.9.024.5510</b>
7S.12.8.230.5110	<b>7S.14.9.024.4310</b>	7S.16.9.110.5420
	7S.14.9.110.4220	7S.16.8.120.5420
7S.32.9.012.5110	7S.14.9.110.4310	7S.16.8.230.5420
<b>7S.32.9.024.5110</b>	7S.14.8.120.4220	
7S.32.8.120.5110	7S.14.8.120.4310	7S.36.9.012.5420
7S.32.8.230.5110	7S.14.8.230.4220	<b>7S.36.9.024.5420</b>
	7S.14.8.230.4310	<b>7S.36.9.024.5510</b>
7S.43.9.012.0211		7S.36.9.110.5420
<b>7S.43.9.024.0211</b>	7S.34.9.012.4220	7S.36.8.120.5420
7S.43.9.048.0211	7S.34.9.012.4310	7S.36.8.230.5420
7S.43.9.110.0211	<b>7S.34.9.024.4220</b>	
	<b>7S.34.9.024.4310</b>	7S.23.9.012.0210
7S.63.9.012.0211	7S.34.9.110.4220	<b>7S.23.9.024.0210</b>
<b>7S.63.9.024.0211</b>	7S.34.9.110.4310	7S.23.9.048.0210
7S.63.9.048.0211	7S.34.8.120.4220	7S.23.9.110.0210
7S.63.9.110.0211	7S.34.8.120.4310	
	7S.34.8.230.4220	
	7S.34.8.230.4310	

## Technical data

Insulation according to EN 61810-1		
Nominal voltage of supply system	V AC	230/400
Rated insulation voltage	V AC	250
Pollution degree		2
Insulation between coil and contact set		
Type of Insulation		Reinforced
Overtoltage category		III
Rated impulse voltage	kV (1.2/50 μs)	6
Dielectric strength	V AC	4000
Insulation between adjacent contacts		
Type of Insulation		Basic
Overtoltage category		III
Rated impulse voltage	kV (1.2/50 μs)	4
Dielectric strength	V AC	2500
Insulation between open contacts		
Type of disconnection		Micro-disconnection
Dielectric strength	V AC/kV (1.2/50 μs)	1500/2.5

Insulation between coil terminals						
Rated impulse voltage (surge) differential mode (according to EN 61000-4-5)	kV (1.2/50 μs)	1.5				
Terminals		Screw Terminal		Screwless Terminal		
Min. wire size		solid cable	stranded cable	solid cable	stranded cable	
	mm <sup>2</sup>	0.5	0.5	0.5	0.5	
	AWG	21	21	21	21	
		Screw Terminal		Screwless Terminal		
Max. wire size		solid cable	stranded cable	solid cable	stranded cable	
	mm <sup>2</sup>	1 x 6 / 2 x 2.5	1 x 4 / 2 x 2.5	1 x 1.5	1 x 1.5	
	AWG	1 x 10 / 2 x 14	1 x 12 / 2 x 14	1 x 14	1 x 16	
Wire strip length	mm	9				
Other data		7S.12/32	7S.14/34	7S.16/36	7S.23	7S.43/63
Bounce time: NO/NC	ms	2/8	2/10	2/10	2/15	1/8
Vibration resistance (10...200)Hz: NO/NC	g	10/5	20/6	20/6	10/2	10/2
Shock resistance: NO/NC	g	20/6	20/5	20/5	20/6	20/5
Power lost to the environment	without contact current	W	0.8	0.8	0.8	1.7
	with rated current	W	1.4	2.3	2.8	3.8

## Contact specifications

### Contact diagrams

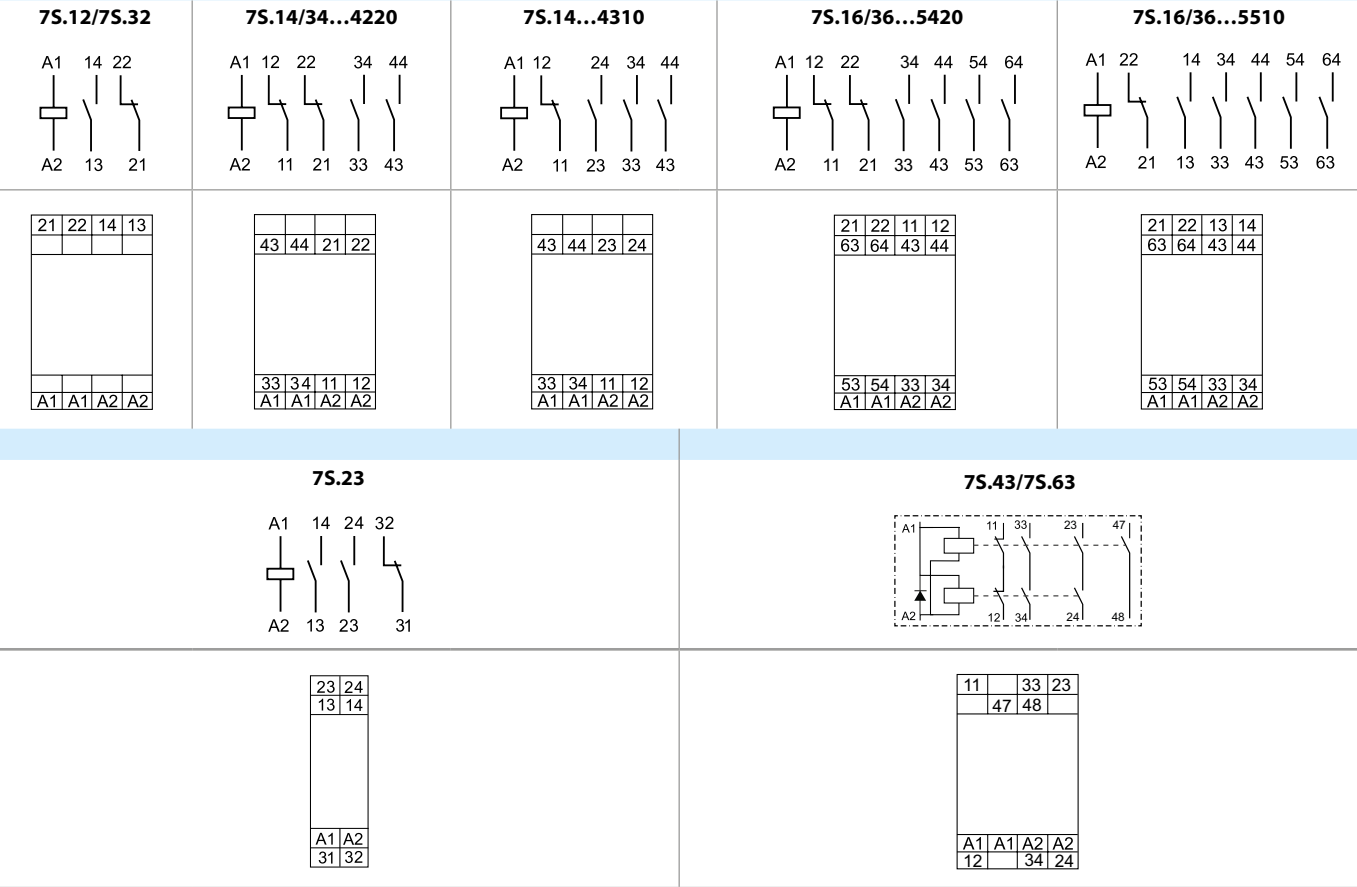

F 7S12 - Electrical life (AC) v contact current - 7S.12

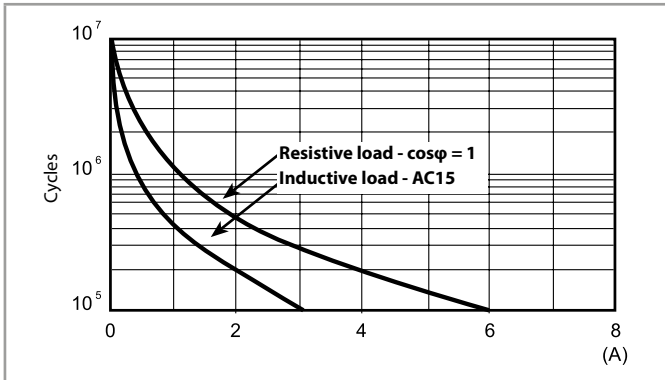

H 7S12\* - Maximum DC breaking capacity - 7S.12

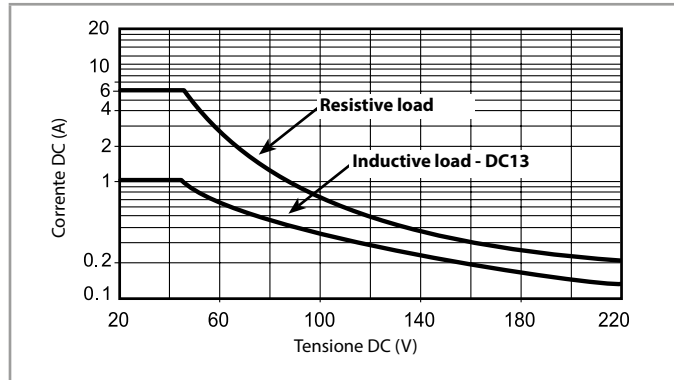

F 7S14 - Electrical life (AC) v contact current - 7S.14/34

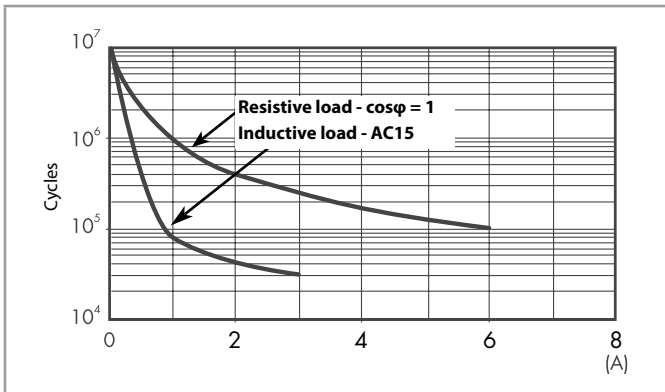

H 7S14\* - Maximum DC1 breaking capacity - 7S.14/34

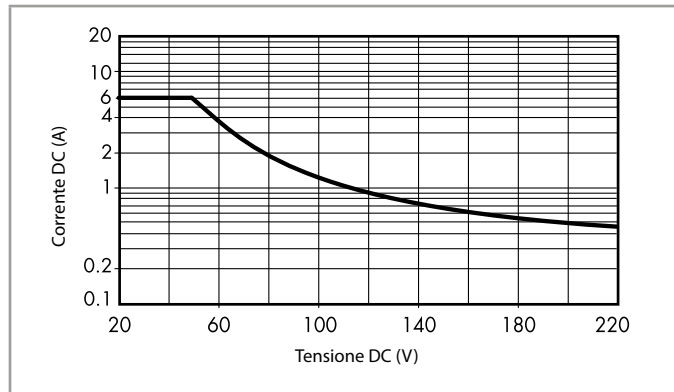

\* When switching a load having voltage and current values under the curve, an electrical life of  $\geq 100 \cdot 10^3$  can be expected.



### Contact specifications

**F 7S16 - Electrical life (AC) v contact current - 7S.16/36**

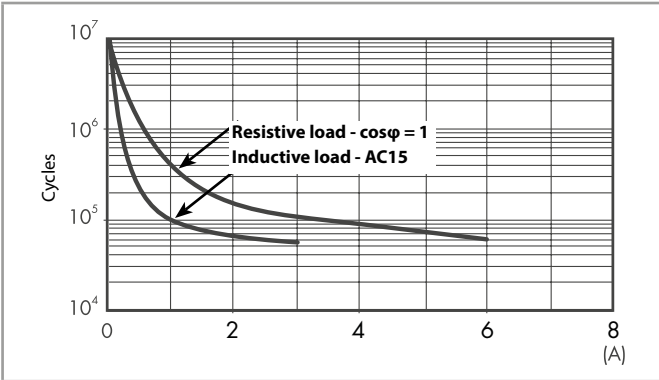

**H 7S16\* - Maximum DC1 breaking capacity - 7S.16/36**

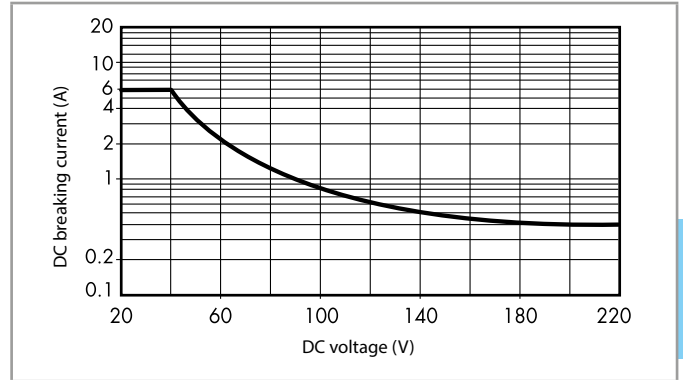

**F 7S23 - Electrical life (AC) v contact current - 7S.23**

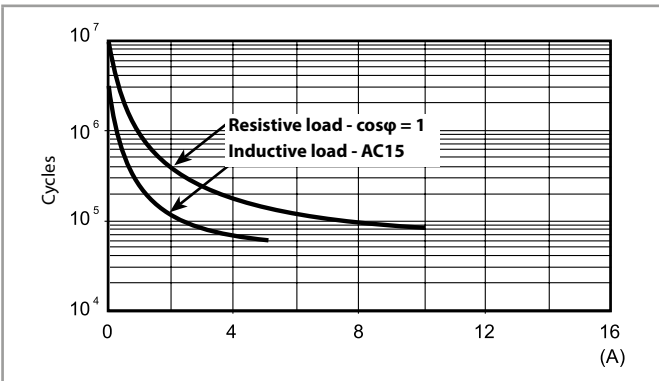

**H 7S23\* - Maximum DC breaking capacity - 7S.23**

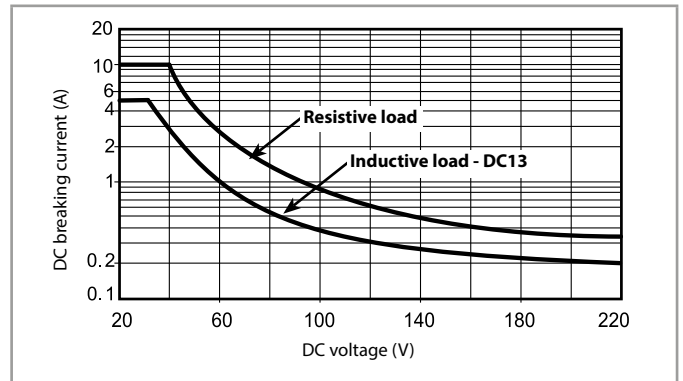

**F 7S43 - Electrical life (AC) v contact current - 7S.43/63**

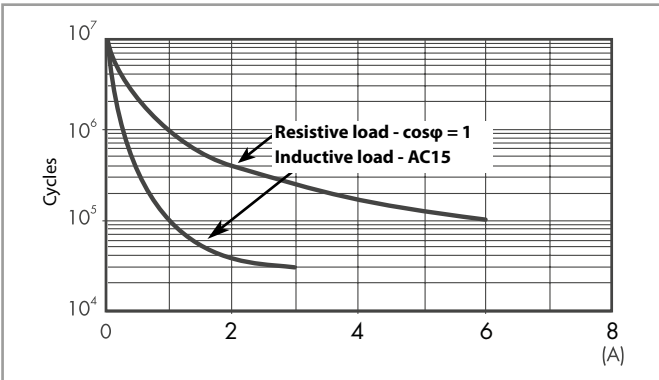

**H 7S43\* - Maximum DC breaking capacity - 7S.43/63**

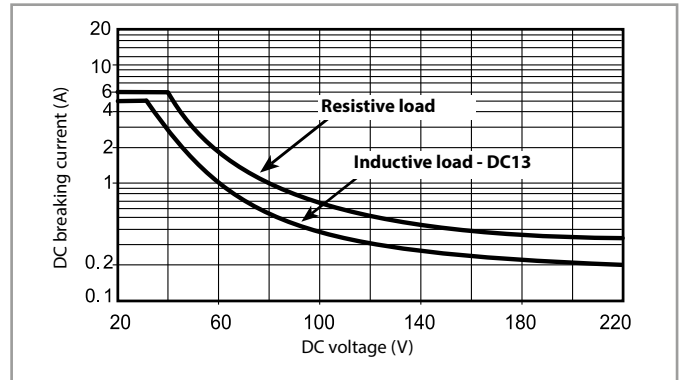

\* When switching a load having voltage and current values under the curve, an electrical life of  $\geq 100 \cdot 10^3$  can be expected.

**H 7S14/34 - Maximum DC13 breaking capacity - 7S.14/34**

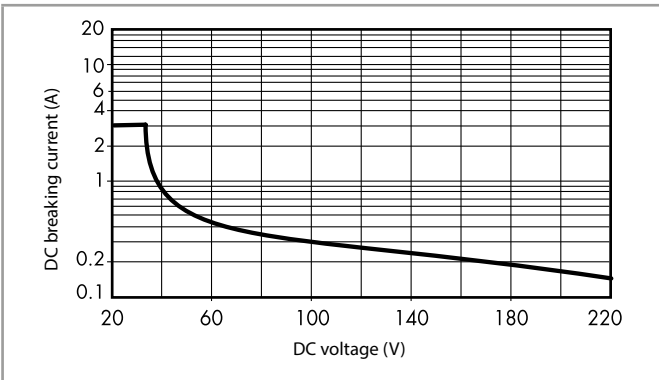

**H 7S16/36 - Maximum DC13 breaking capacity - 7S.16/36**

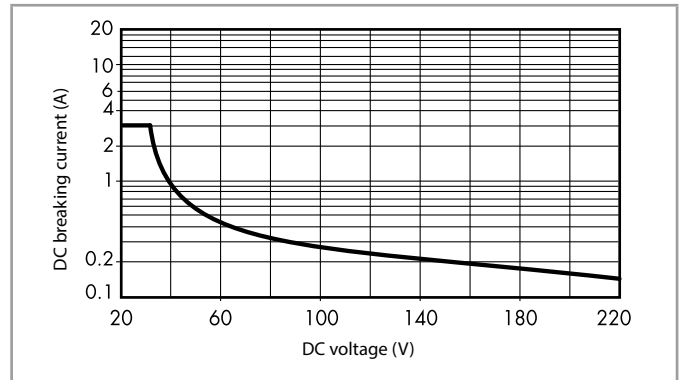

### Coil specifications

#### DC coil data - type 7S.12/32

Nominal voltage	Coil code	Operating range		Rated input current at $U_N$	Rated power at $U_N$
		$U_{min}$	$U_{max}$		
$U_N$		V	V	$I_N$	W
V		V	V	mA	W
12	9.012	9.6	14.4	55	0.7
24	9.024	16.8	30	38.2	0.9

#### AC coil data - type 7S.12/32

Nominal voltage	Coil code	Operating range		Rated input current at $U_N$	Rated power at $U_N$
		$U_{min}$	$U_{max}$		
$U_N$		V	V	$I_N$	VA/W
V		V	V	mA	VA/W
110...125	8.120	93	138	9.8	1.2/1.1
230...240	8.230	195	264	11.8	2.8/1.2

#### DC coil data - type 7S.14/34 / 7S.16/36

Nominal voltage	Coil code	Operating range		Rated input current at $U_N$	Rated power at $U_N$
		$U_{min}$	$U_{max}$		
$U_N$		V	V	$I_N$	W
V		V	V	mA	W
12	9.012	9.6	14.4	64.7	0.8
24	9.024	16.8	30	42.2	1
110	9.110	77	138	11.6	1.4

#### AC coil data - type 7S.14/34 / 7S.16/36

Nominal voltage	Coil code	Operating range		Rated input current at $U_N$	Rated power at $U_N$
		$U_{min}$	$U_{max}$		
$U_N$		V	V	$I_N$	VA/W
V		V	V	mA	VA/W
110...125	8.120	93	138	10.2	1.3/1.1
230...240	8.230	195	264	11.8	2.9/1.2

#### DC coil data - type 7S.23

Nominal voltage	Coil code	Operating range		Rated input current at $U_N$	Rated power at $U_N$
		$U_{min}$	$U_{max}$		
$U_N$		V	V	$I_N$	W
V		V	V	mA	W
12	9.012	9.6	14.4	47.1	0.6
24	9.024	16.8	30	26.6	0.6
48	9.048	33.6	60	16.2	0.8
110	9.110	77	138	8.8	1

#### DC coil data - type 7S.43/63

Nominal voltage	Coil code	Operating range		Rated input current at $U_N$	Rated power at $U_N$
		$U_{min}$	$U_{max}$		
$U_N$		V	V	$I_N$	W
V		V	V	mA	W
12	9.012	10.2	13.2	105	1.3
24	9.024	20.4	26.4	60	1.45
48	9.048	40.8	52.8	36	1.6
110	9.110	93.5	121	20	1.7

#### R 7S - DC coil operating range v ambient temperature - 7S.12/32 / 7S.23 / 7S.14/34 / 7S.16/36

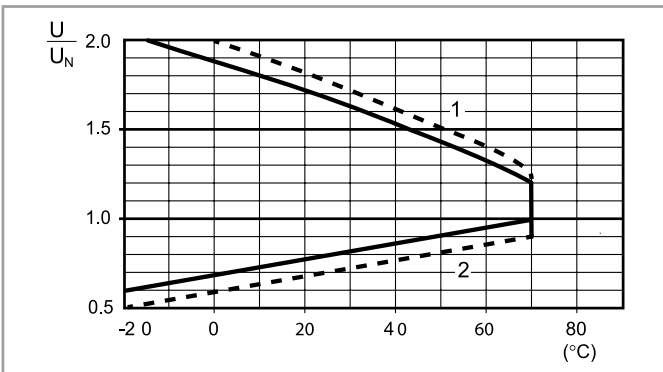

- 1 - Max. permitted coil voltage.
- 2 - Min. pick-up voltage with coil at ambient temperature.
- 24 and 110 V DC coils only excluding 7S.23

#### R 7S - AC coil operating range v ambient temperature - 7S.12/32 / 7S.14/34 / 7S.16/36

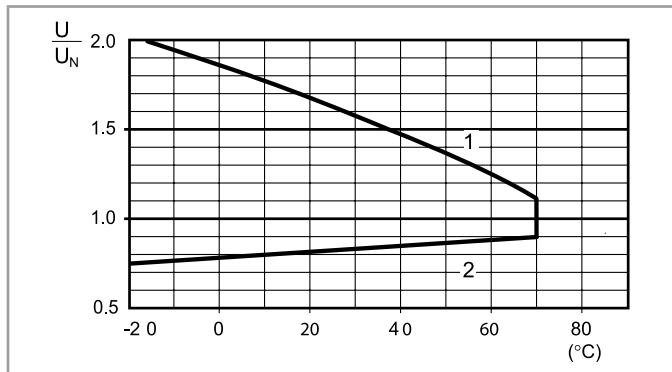

- 1 - Max. permitted coil voltage.
- 2 - Min. pick-up voltage with coil at ambient temperature.

#### R 7S - DC coil operating range v ambient temperature - 7S.43/63

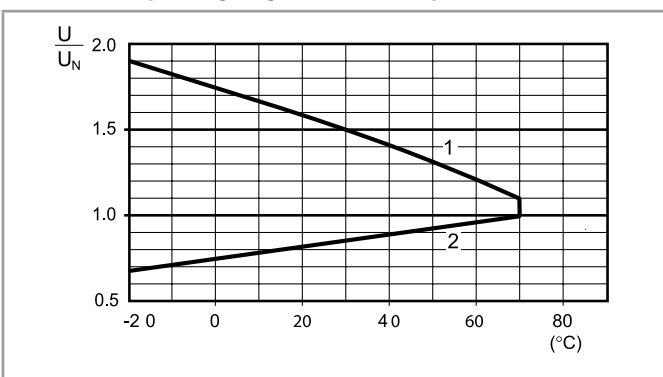

- 1 - Max. permitted coil voltage.
- 2 - Min. pick-up voltage with coil at ambient temperature.

Example wiring diagrams

Type 75.x2

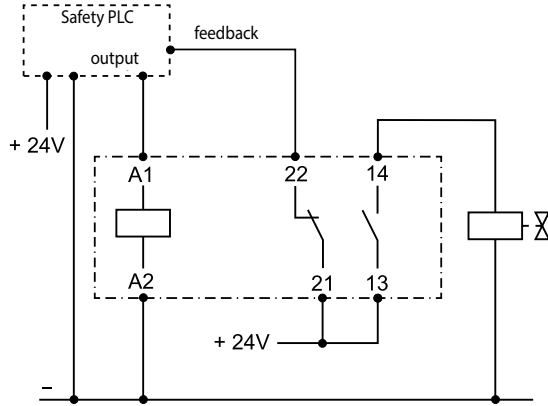

Type 75.x4...4220

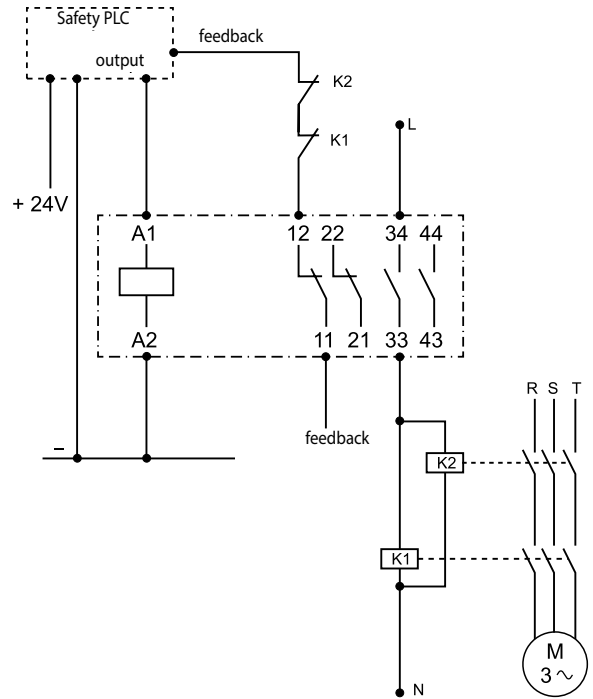

Type 75.43

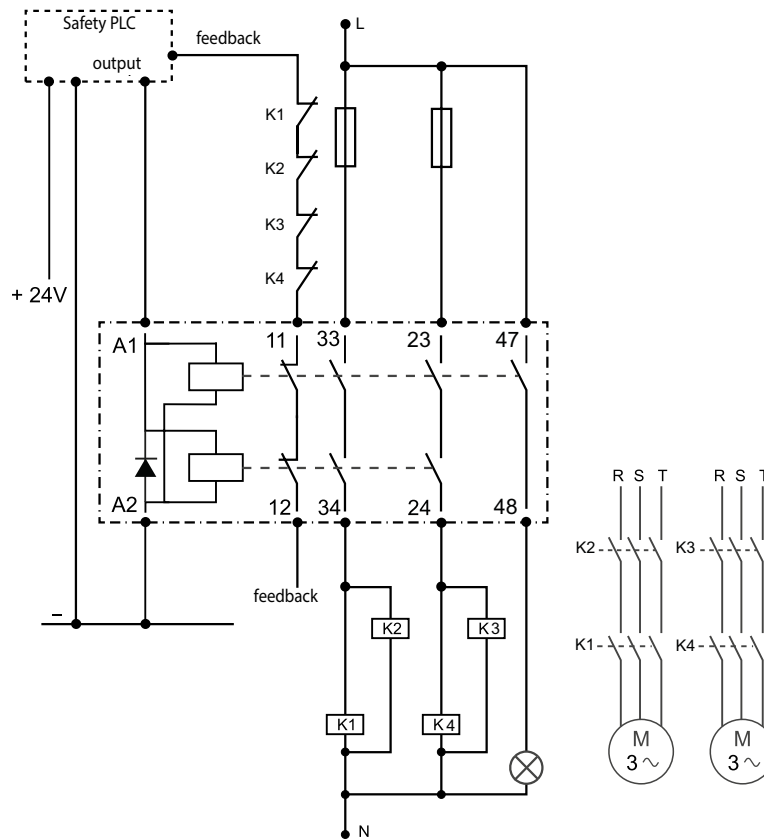

### Outline drawings

Types 75.12/14/16/43  
Screwless terminal

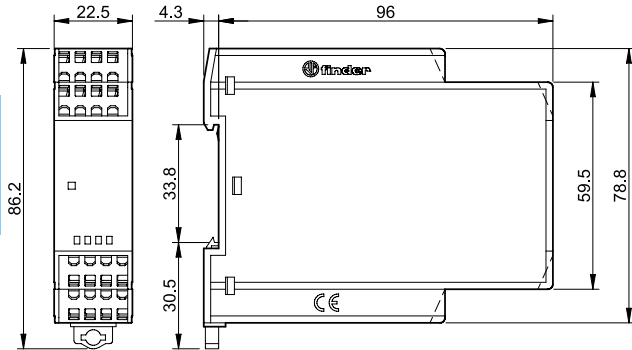

Type 75.23  
Screw terminal

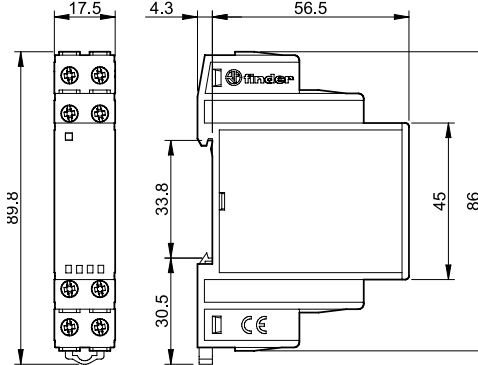

Type 75.32  
Screw terminal

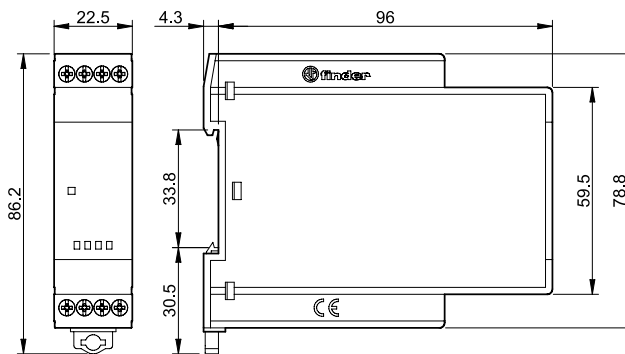

Type 75.34  
Screw terminal

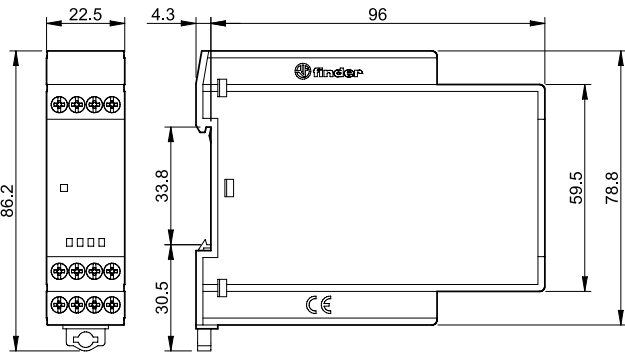

Type 75.36  
Screw terminal

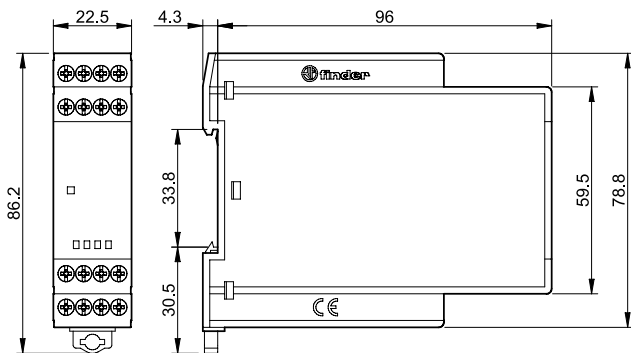

Type 75.63  
Screw terminal

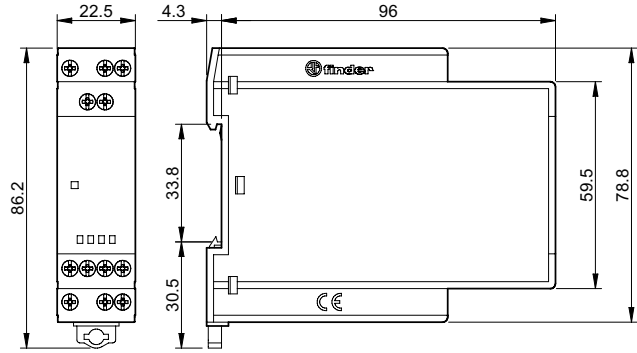

### Accessories

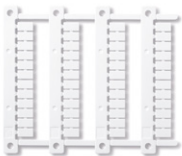

060.48

Sheet of marker tags, plastic, 48 tags, 6 x 12 mm, for CEMBRE thermal transfer printers

060.48

# Solid State Relays

## 5 - 15 - 25 - 30 - 50 A

**77**  
SERIES



Drying kilns



Heating and cooling



Lighting control in corridors (for hotels, offices and hospitals)



Bottling plant



Labelling machines



Packaging machines

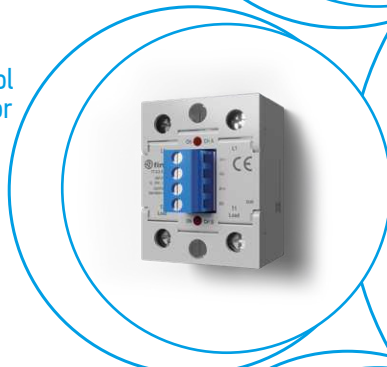



**5 A modular SSR, 1 NO AC output**

- 17.5 mm housing
- 60 to 240 V AC output (with back to back SCR)
- 5 kV (1.2/50 µs) insulation between Input and Output
- Zero-crossing and random switch-on versions available
- High switching speed
- High endurance
- Silent switching
- Spark and bounce-free switching
- Low control power
- 3-phase general purpose
- 35 mm rail (EN 60715) mount

77.01

Screw terminal



\* See L77-8 diagram page 18

\*\* See L77-1 and L77-2 diagrams page 17

For outline drawing see page 24

**Output specification**

Output configuration	1 NO (SPST-NO)		1 NO (SPST-NO)	
Rated current I <sub>N</sub> /Max. peak current* (10 ms)	A	5/300*	A	5/300*
Rated voltage	V AC (50/60 Hz)	230	V AC (50/60 Hz)	230
Switching voltage range	V AC (50/60 Hz)	48...265	V AC (50/60 Hz)	48...265
Repetitive peak off-state voltage	V <sub>pk</sub>	800	V <sub>pk</sub>	800
Rated load AC7a (cos φ = 0.8)	A	5	A	5
Rated load AC15	A	5	A	3
Single phase motor rating (230 V AC)	kW	—	kW	0.1
Nominal lamp rating:				
230 V incandescent/halogen W		1000		800
fluorescent tubes with electronic ballast W		1000		800
fluorescent tubes with electromagnetic ballast W		1000		800
CFL W		800		400
230 V LED W		800		400
LV halogen or LED with electronic ballast W		800		400
LV halogen or LED with electromagnetic ballast W		1000		800
Minimum switching current @ 230 V	mA	100	mA	100
Typical "OFF-state" leakage current @ 230 V	mA	0.5	mA	3.5
Max "ON-state" voltage drop @ 25 °C and 5 A/100 mA	V	0.85/1.5	V	0.85/1.5
Power loss @ 5 A	W	4	W	4

**Input specification**

Nominal voltage (U <sub>N</sub> )	V AC (50/60 Hz)	—	230	—	230
	V DC	6...24	—	6...24	—
Rated power	VA (50 Hz)/W	—/0.4	3.6/0.3	—/0.4	3.6/0.3
Operating range	V AC (50/60 Hz)	—	90...265	—	90...265
	V DC	4...32	—	4...32	—
Must drop-out voltage	V AC (50/60 Hz)/DC	3	24	3	24

**Technical data**

Electrical life	cycles	10 · 10 <sup>6</sup>	cycles	10 · 10 <sup>6</sup>
Operate/release time	ms	20/12	ms	9/8
Insulation between input and output (1.2/50 µs)	kV	5	kV	5
Ambient temperature	°C	-20...+70**	°C	-20...+70**
Protection category		IP 20		IP 20

**Approvals** (according to type)

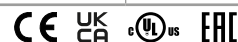

**77.01.x.xxx.8050**



**Zero-crossing switch-on  
Suggested applications:**

- Lamp inrush current reduction (CFL - Compact Fluorescent energy-saving Lamps and similar)
- Heater control
- Solenoid, contactor driver

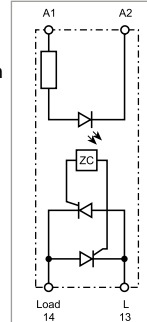

Simplified circuit diagram

**77.01.x.xxx.8051**



**Random switch-on**

**Suggested applications:**

- Finer control requiring short operate time (specially motor control)
- AC Input phase different from AC Output phase

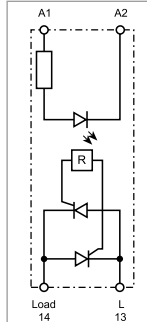

Simplified circuit diagram

**7 - 15 A modular SSR, 1 NO DC output**

- 17.5 mm housing
- 2 versions, for 24 and 125 V DC mosfet output
- 4 kV (1.2/50  $\mu$ s) insulation between Input and Output
- Short circuit protection
- High switching speed
- High endurance
- Silent switching
- Spark and bounce-free switching
- Low control power
- Suitable for railway applications
- 35 mm rail (EN 60715) mount

77.01

Screw terminal



D

\* See L77-3 and L77-4 diagrams page 17

For outline drawing see page 24

**Output specification**

Output configuration		1 NO (SPST-NO)	1 NO (SPST-NO)
Rated current $I_N$ /Max. peak current (10 ms)	A	15/160	7/60
Rated voltage	V DC	24	125
Switching voltage range	V DC	16...32	43...140
Rated load DC13	A	5	2.5
DC motor rating	kW	0.2	—
Minimum switching current	mA	100	50
Typical "OFF-state" leakage current	mA	3	6
Max "ON-state" voltage drop @ 25 °C and $I_N$	V	0.06	0.2
Power loss @ $I_N$	W	1	1.5
<b>Input specification</b>			
Nominal voltage ( $U_N$ )	V DC	6...24	6...24
Rated power	W	0.4	0.4
Operating range	V DC	4...32	4...32
Must drop-out voltage	V DC	3	3
<b>Technical data</b>			
Electrical life	cycles	$10 \cdot 10^6$	$10 \cdot 10^6$
Operate/release time	ms	0.05/2	0.05/2
Insulation between input and output (1.2/50 $\mu$ s)	kV	4	4
Ambient temperature	°C	-20...+70*	-20...+70*
Protection category		IP 20	IP 20

Approvals (according to type)



**77.01.9.024.9024**



**24 V DC output switching  
15 A rated**

**Applications in Energy, Automation and Machines:**

- Control of electric, pneumatic and hydraulic electromagnetic valves
- Direct control of loads such as motors and electromagnets

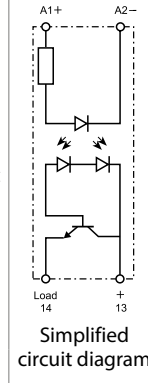

**77.01.9.024.9125**



**110...125 V DC output switching  
7 A rated**

**Applications in Energy, Automation and Machines:**

- Control of electric, pneumatic and hydraulic electromagnetic valves
- Direct control of loads such as motors and electromagnets

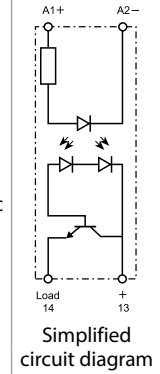



**15 A modular SSR, 1 NO output**

- 22.5 mm housing, heat-sink + plastic cover
- 24 to 277 V AC output (with TRIAC)
- 6 kV (1.2/50 μs) insulation between Input and Output
- Zero-crossing and random switch-on versions available
- High switching speed
- High endurance
- Silent switching
- Spark and bounce-free switching
- Low control power
- 3-phase general purpose
- "Relay-style" terminal arrangement (input and output terminals on opposite sides)
- 35 mm rail (EN 60715) mount

77.11  
Screw terminal



\* See L77-9 diagram page 18  
\*\* See L77-5 diagrams page 17

For outline drawing see page 24

**Output specification**

Output configuration	1 NO (SPST-NO)		1 NO (SPST-NO)	
Rated current I <sub>N</sub> /Max. peak current* (10 ms) A	15/400*		15/400*	
Rated voltage V AC (50/60 Hz)	230		230	
Switching voltage range V AC (50/60 Hz)	19...305		19...305	
Repetitive peak off-state voltage V <sub>pk</sub>	800		800	
Rated load AC7a (cos φ = 0.8, @ 25 °C) A	20		20	
Rated load AC15 A	15		15	
Single phase motor rating (230 V AC) kW	—		0.75	
Nominal lamp rating:				
230 V incandescent/halogen W	4000		2500	
fluorescent tubes with electronic ballast W	4000		2500	
fluorescent tubes with electromagnetic ballast W	2000		1000	
CFL W	3000		1500	
230 V LED W	3000		1500	
LV halogen or LED with electronic ballast W	3000		1500	
LV halogen or LED with electromagnetic ballast W	3000		1500	
Minimum switching current @ 250 V mA	100		100	
Typical "OFF-state" leakage current @ 250 V mA	1		1	
Max "ON-state" voltage drop @ 25 °C and 15 A V	1.55		1.55	
Power loss @ 15 A W	14		14	

**Input specification**

Nominal voltage (U <sub>N</sub> )	V AC (50/60 Hz)	—	230	—	230
	V DC	24	—	24	—
Rated power VA (50 Hz)/W		0.4	7.5/0.9	0.4	7.5/0.9
Operating range	V AC (50/60 Hz)	—	40...305	—	40...305
	V DC	4...32	—	4...32	—
Must drop-out voltage	V AC (50/60 Hz)/DC	—/2	6/—	—/2	6/—

**Technical data**

Electrical life	cycles	10 · 10 <sup>6</sup>		10 · 10 <sup>6</sup>	
Operate/release time	ms	< 10/< 10	< 10/< 30	< 1/< 10	< 2/< 25
Insulation between input and output (1.2/50 μs)	kV	6		6	
Ambient temperature	°C	-20...+80**		-20...+80**	
Protection category		IP 20		IP 20	

**Approvals** (according to type)

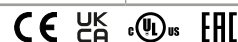

**77.11.x.xxx.8250**



**Zero-crossing switch-on**

**Suggested applications:**

- Lamp inrush current reduction (CFL - Compact Fluorescent energy-saving Lamps and similar)
- Heater control
- Solenoid, contactor driver

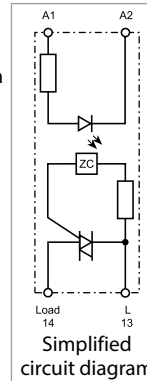

**77.11.x.xxx.8251**



**Random switch-on**

**Suggested applications:**

- Fine controls involving shorter time (specially motor control)

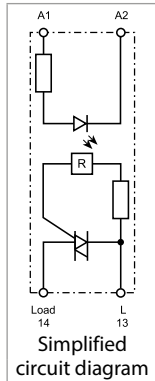

**25 A modular SSR, 1 NO output**

- 22.5 mm housing, heat-sink + plastic cover
- 24 to 277 V AC output (with TRIAC)
- 6 kV (1.2/50 μs) insulation between Input and Output
- Zero-crossing and random switch-on versions available
- High switching speed
- High endurance
- Silent switching
- Spark and bounce-free switching
- Low control power
- 3-phase general purpose
- "Relay-style" terminal arrangement (input and output terminals on opposite sides)
- 35 mm rail (EN 60715) mount

77.21  
Screw terminal



\* See L77-10 diagram page 18  
\*\* See L77-6 diagrams page 17

For outline drawing see page 24

**Output specification**

Output configuration		1 NO (SPST-NO)	1 NO (SPST-NO)
Rated current (@40 °C) I <sub>N</sub> / Max. peak current* (10 ms)	A	25/400*	25/400*
Rated voltage	V AC (50/60 Hz)	230	230
Switching voltage range	V AC (50/60 Hz)	19...305	19...305
Repetitive peak off-state voltage	V <sub>pk</sub>	800	800
Rated load AC7a (cos φ = 0.8, @ 25 °C)	A	25	25
Rated load AC15	A	25	25
Single phase motor rating (230 V AC)	kW	1	1
Nominal lamp rating:			
230 V incandescent/halogen W		4000	2500
fluorescent tubes with electronic ballast W		4000	2500
fluorescent tubes with electromagnetic ballast W		2000	1000
CFL W		3000	1500
230 V LED W		3000	1500
LV halogen or LED with electronic ballast W		3000	1500
LV halogen or LED with electromagnetic ballast W		3000	1500
Minimum switching current @ 250 V	mA	100	100
Typical "OFF-state" leakage current @ 250 V	mA	1	1
Max "ON-state" voltage drop @ 25 °C and 25 A	V	1.55	1.55
Power loss @ 25 A	W	14	14

**Input specification**

Nominal voltage (U <sub>N</sub> )	V AC (50/60 Hz)	—	230	—	230
	V DC	24	—	24	—
Rated power @ U <sub>MAX</sub>	VA (50 Hz)/W	0.4	7.5/0.9	0.4	7.5/0.9
Operating range	V AC (50/60 Hz)	—	40...305	—	40...305
	V DC	4...32	—	4...32	—
Must drop-out voltage	V AC (50/60 Hz)/DC	—/2	6/—	—/2	6/—

**Technical data**

Electrical life	cycles	10 · 10 <sup>6</sup>	10 · 10 <sup>6</sup>
Operate/release time	ms	< 10/< 10	< 10/< 30
Insulation between input and output (1.2/50 μs)	kV	6	6
Ambient temperature	°C	-20...+80**	-20...+80**
Protection category		IP 20	IP 20

**Approvals** (according to type)



**NEW 77.21.x.xxx.8250**



**Zero-crossing switch-on  
Suggested applications:**

- Lamp inrush current reduction (CFL - Compact Fluorescent energy-saving Lamps and similar)
- Heater control
- Solenoid, contactor driver

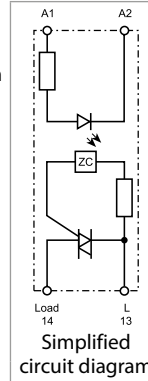

**NEW 77.21.x.xxx.8251**



**Random switch-on  
Suggested applications:**

- Finer control requiring short operate time (specially motor control)

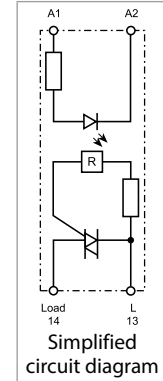

**30 A modular SSR, 1 NO output**

- 22.5 mm housing, heat-sink + plastic cover
- 60 to 440 V AC output (with back to back SCR)
- 6 kV (1.2/50 μs) insulation between Input and Output
- Zero-crossing and random switch-on versions available
- High switching speed
- High endurance
- Silent switching
- Spark and bounce-free switching
- Low control power
- 3-phase general purpose
- "Relay-style" terminal arrangement (input and output terminals on opposite sides)
- 35 mm rail (EN 60715) mount

77.31  
Screw terminal



\* See L77-11 diagram page 18  
\*\* See L77-7 diagrams page 17

For outline drawing see page 24

**Output specification**

Output configuration	1 NO (SPST-NO)		1 NO (SPST-NO)	
Rated current $I_N$ /Max. peak current* (10 ms) A	30/520*		30/520*	
Rated voltage V AC (50/60 Hz)	400		400	
Switching voltage range V AC (50/60 Hz)	48...480		48...480	
Repetitive peak off-state voltage $V_{pk}$	1100		1100	
Rated load AC7a (cos φ = 0.8) A	30		30	
Rated load AC15 A	20		20	
Single phase motor rating (230 V AC) kW	—		1.5	
Nominal lamp rating:				
230 V incandescent/halogen W	6000		4500	
fluorescent tubes with electronic ballast W	6000		4000	
fluorescent tubes with electromagnetic ballast W	3000		1800	
CFL W	4000		2500	
230 V LED W	4000		2500	
LV halogen or LED with electronic ballast W	4000		2500	
LV halogen or LED with electromagnetic ballast W	4000		2500	
Minimum switching current @ 400 V mA	300		300	
Typical "OFF-state" leakage current @ 400 V mA	1		1	
Max "ON-state" voltage drop @ 25 °C and 30 A V	0.85		0.85	
Power loss @ 30 A W	16		16	

**Input specification**

Nominal voltage ( $U_N$ )	V AC (50/60 Hz)	24	230	—	230
	V DC	24	—	24	—
Rated power @ $U_{MAX}$	VA (50 Hz)/W	0.24/0.4	7.5/0.9	0.4	7.5/0.9
Operating range	V AC (50/60 Hz)	16...32	40...280	—	40...280
	V DC	16...32	—	4...32	—
Must drop-out voltage	V AC (50/60 Hz)/DC	6/2	6/—	—/2	6/—

**Technical data**

Electrical life	cycles	10 · 10 <sup>6</sup>		10 · 10 <sup>6</sup>	
Operate/release time	ms	< 10/< 10	< 10/< 30	< 1/< 10	< 2/< 25
Insulation between input and output (1.2/50 μs)	kV	6		6	
Ambient temperature	°C	-20...+80**		-20...+80**	
Protection category		IP 20		IP 20	

**Approvals** (according to type)

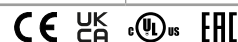

**77.31.x.xxx.8050**



**Zero-crossing switch-on**  
**Suggested applications:**

- Lamp inrush current reduction (CFL - Compact Fluorescent energy-saving Lamps and similar)
- Heater control
- Solenoid, contactor driver

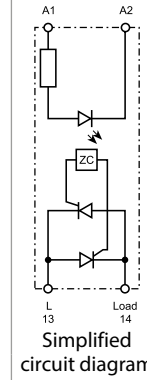

**77.31.x.xxx.8051**



**Random switch-on**  
**Suggested applications:**

- Finer control requiring short operate time (specially motor control)

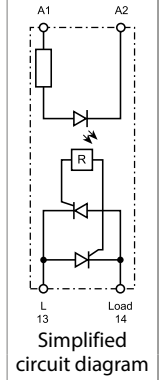

**30 A modular SSR, 1 NO output**

- 22.5 mm housing, heat-sink + plastic cover
- 60 to 440 V AC output (with back to back SCR)
- 6 kV (1.2/50 μs) insulation between Input and Output
- Zero-crossing and random switch-on versions available
- High switching speed
- High endurance
- Silent switching
- Spark and bounce-free switching
- Low control power
- 3-phase general purpose
- "Contactor-style" terminal arrangement (input and output terminals on adjacent sides)
- 35 mm rail (EN 60715) mount

77.31  
Screw terminal



\* See L77-11 diagram page 18  
\*\* See L77-7 diagrams page 17

For outline drawing see page 24

**Output specification**

Output configuration	1 NO (SPST-NO)		1 NO (SPST-NO)	
Rated current I <sub>N</sub> /Max. peak current* (10 ms) A	30/520*		30/520*	
Rated voltage V AC (50/60 Hz)	400		400	
Switching voltage range V AC (50/60 Hz)	48...480		48...480	
Repetitive peak off-state voltage V <sub>pk</sub>	1100		1100	
Rated load AC7a (cos φ = 0.8) A	30		30	
Rated load AC15 A	20		20	
Single phase motor rating (230 V AC) kW	—		1.5	
Nominal lamp rating:				
230 V incandescent/halogen W	6000		4500	
fluorescent tubes with electronic ballast W	6000		4000	
fluorescent tubes with electromagnetic ballast W	3000		1800	
CFL W	4000		2500	
230 V LED W	4000		2500	
LV halogen or LED with electronic ballast W	4000		2500	
LV halogen or LED with electromagnetic ballast W	4000		2500	
Minimum switching current @ 400 V mA	300		300	
Typical "OFF-state" leakage current @ 400 V mA	1		1	
Max "ON-state" voltage drop @ 25 °C and 30 A V	0.85		0.85	
Power loss @ 30 A W	16		16	

**Input specification**

Nominal voltage (U <sub>N</sub> )	V AC (50/60 Hz)	—	230	—	230
	V DC	24	—	24	—
Rated power VA (50 Hz)/W		0.4	7.5/0.9	0.4	7.5/0.9
Operating range	V AC (50/60 Hz)	—	40...280	—	40...280
	V DC	4...32	—	4...32	—
Must drop-out voltage V AC (50/60 Hz)/DC		—/2	6/—	—/2	6/—

**Technical data**

Electrical life cycles		10 · 10 <sup>6</sup>		10 · 10 <sup>6</sup>	
Operate/release time ms		< 10/< 10	< 10/< 30	< 1/< 10	< 2/< 25
Insulation between input and output (1.2/50 μs) kV		6		6	
Ambient temperature °C		-20...+80**		-20...+80**	
Protection category		IP 20		IP 20	

**Approvals** (according to type)



**77.31.x.xxx.8070**



**Zero-crossing switch-on**

**Suggested applications:**

- Lamp inrush current reduction (CFL - Compact Fluorescent energy-saving Lamps and similar)
- Heater control
- Solenoid, contactor driver

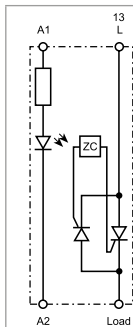

Simplified circuit diagram

**77.31.x.xxx.8071**



**Random switch-on**

**Suggested applications:**

- Fine controls involving shorter time (specially motor control)

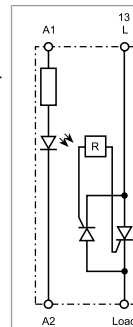

Simplified circuit diagram

25, 40 and 60 A panel Zero-crossing SSR, "hockey puck" style

Type 77.A1.x.xxx.8x50: 25 A

Type 77.B1.x.xxx.8x50: 40 A

Type 77.D1.x.xxx.8x50: 60 A

8250: 24 to 280 VAC switching load voltage

8650: 24 to 660 VAC switching load voltage

- "hockey puck" housing with folding screw cover
- High endurance and switching speed
- Silent switching
- Spark and bounce-free switching
- Low control power
- "Relay-style": input and output terminals on opposite sides
- Mounting on control cabinet sheet metal or on heatsink

77.A1/B1/D1  
Screw terminal (plate clamp)



\* See L77-13, L77-14 and L77-15 diagrams page 19

Four outline drawing see page 24

	77...8250		77...8650		77...8250		77...8650		77...8250		77...8650		
	Output configuration	1 NO		1 NO		1 NO		1 NO		1 NO		1 NO	
Rated current $I_N$ /Max. peak current (10 ms)	A	25/300		40/500		60/700							
Rated voltage	V AC (50/60 Hz)	240	600	240	600	240	600	240	600	240	600	240	600
Switching voltage range	V AC (50/60 Hz)	24...280	24...660	24...280	24...660	24...280	24...660	24...280	24...660	24...280	24...660	24...280	24...660
Repetitive peak off-state voltage	$V_{pk}$	600	1600	600	1600	600	1600	600	1600	600	1600	600	1600
Minimum switching current @ 250 V	mA	100		100		100							
Typical "OFF-state" leakage current @ rated voltage	mA	0.1		0.1		0.1							
Max "ON-state" voltage drop @ 25 °C and $I_N$	V	1.5		1.5		1.5							
Power loss @ $I_N$	W	30		48		72							
<b>Input specification</b>													
Nominal voltage ( $U_N$ )	V AC (50/60 Hz)	—	230	—	230	—	230	—	230	—	230	—	230
	V DC	24	—	24	—	24	—	24	—	24	—	24	—
Rated power @ $U_{MAX}$	VA (50 Hz)/W	—/0.55	5.3/—	—/0.55	5.3/—	—/0.55	5.3/—	—/0.55	5.3/—	—/0.55	5.3/—	—/0.55	5.3/—
Operating range	V AC (50/60 Hz)	—	90...280	—	90...280	—	90...280	—	90...280	—	90...280	—	90...280
	V DC	3...32	—	3...32	—	3...32	—	3...32	—	3...32	—	3...32	—
Must drop-out voltage	V AC (50/60 Hz)/DC	—/1	15/—	—/1	15/—	—/1	15/—	—/1	15/—	—/1	15/—	—/1	15/—
<b>Technical data</b>													
Electrical life	cycles	—		—		—							
Operate/release time	ms	10/10	40/20	10/10	40/20	10/10	40/20	10/10	40/20	10/10	40/20	10/10	40/20
Insulation between input and output (1.2/50 $\mu$ s)	kV	—		—		—							
Ambient temperature	°C	-30...+80*		-30...+80*		-30...+80*							
Protection category		IP 20		IP 20		IP 20							
<b>Approvals</b> (according to type)													

**80, 100 and 125 A panel Zero-crossing SSR, "hockey puck" style**

**Type 77.F1.x.xxx.8x50:** 80 A

**Type 77.G1.x.xxx.8x50:** 100 A

**Type 77.H1.x.xxx.8x50:** 125 A

**8250:** 24 to 280 VAC switching load voltage

**8650:** 24 to 660 VAC switching load voltage

- "hockey puck" housing with folding screw cover
- High endurance and switching speed
- Silent switching
- Spark and bounce-free switching
- Low control power
- "Relay-style": input and output terminals on opposite sides
- Mounting on control cabinet sheet metal or on heatsink

77.F1/G1/H1  
Screw terminal (plate clamp)



**NEW 77.F1.x.xxx.8x50**



**Zero-crossing switch-on**

- Output: 80 A
- Suggested applications: heater control, lamps, solenoid, contactor driver

**NEW 77.G1.x.xxx.8x50**



**Zero-crossing switch-on**

- Output: 100 A
- Suggested applications: heater control, lamps, solenoid, contactor driver

**NEW 77.H1.x.xxx.8x50**



**Zero-crossing switch-on**

- Output: 125 A
- Suggested applications: heater control, lamps, solenoid, contactor driver

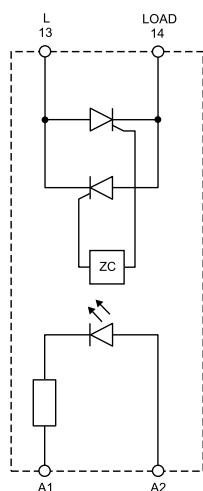

Simplified circuit diagram

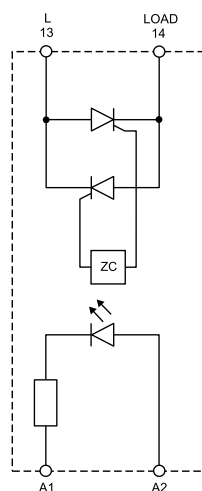

Simplified circuit diagram

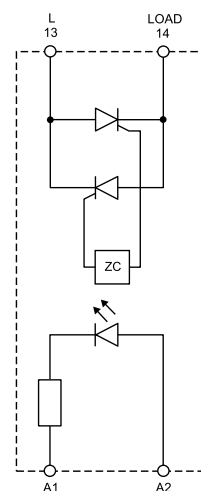

Simplified circuit diagram

\* See L77-16, L77-17 and L77-18 diagrams page 19

For outline drawing see page 24

Output specification		77...8250		77...8650		77...8250		77...8650		77...8250		77...8650	
		1 NO		1 NO		1 NO		1 NO		1 NO		1 NO	
Output configuration		1 NO		1 NO		1 NO		1 NO		1 NO		1 NO	
Rated current $I_N$ /Max. peak current (10 ms)	A	80/800		80/800		100/1500		100/1500		125/2250		125/2250	
Rated voltage	V AC (50/60 Hz)	240		600		240		600		240		600	
Switching voltage range	V AC (50/60 Hz)	24...280		24...660		24...280		24...660		24...280		24...660	
Repetitive peak off-state voltage	$V_{pk}$	600		1600		600		1600		600		1600	
Minimum switching current @ 250 V	mA	100		100		100		100		100		100	
Typical "OFF-state" leakage current @ rated voltage	mA	0.1		0.1		0.1		0.1		0.1		0.1	
Max "ON-state" voltage drop @ 25 °C and $I_N$	V	1.5		1.5		1.5		1.5		1.5		1.5	
Power loss @ $I_N$	W	96		96		120		120		150		150	
<b>Input specification</b>													
Nominal voltage ( $U_N$ )	V AC (50/60 Hz)	—		230		—		230		—		230	
	V DC	24		—		24		—		24		—	
Rated power @ $U_{MAX}$	VA (50 Hz)/W	—/0.55		5.3/—		—/0.55		5.3/—		—/0.55		5.3/—	
Operating range	V AC (50/60 Hz)	—		90...280		—		90...280		—		90...280	
	V DC	3...32		—		3...32		—		3...32		—	
Must drop-out voltage	V AC (50/60 Hz)/DC	—/1		15/—		—/1		15/—		—/1		15/—	
<b>Technical data</b>													
Electrical life	cycles	—		—		—		—		—		—	
Operate/release time	ms	10/10		40/20		10/10		40/20		10/10		40/20	
Insulation between input and output (1.2/50 $\mu$ s)	kV	—		—		—		—		—		—	
Ambient temperature	°C	—30...+80*		—30...+80*		—30...+80*		—30...+80*		—30...+80*		—30...+80*	
Protection category		—		—		—		—		—		—	
<b>Approvals (according to type)</b>													
		CE		UK EAC		cRU		US					

**25, 50 and 75 A dual phase Random SSR, "hockey puck" style with 2 independent channel**

**Type 77.A2.9.024.8671:** 25 A - 600 V AC

**Type 77.C2.9.024.8671:** 50 A - 600 V AC

**Type 77.E2.9.024.8671:** 75 A - 600 V AC

- 2 independent output channel driven by independent low power DC input
- "hockey puck" housing with folding screw cover
- High endurance and switching speed
- Silent switching
- Spark and bounce-free switching
- "contactor-style": input and output terminals on adjacent sides
- Mounting on control cabinet sheet metal or on heatsink

77.A2/C2/E2  
Screw terminal (plate clamp)



**NEW 77.A2.9.024.8671**



**Random switch-on**

- Output: 25 A/600 V AC
- Suggested applications: heater or motor control

**NEW 77.C2.9.024.8671**



**Random switch-on**

- Output: 50 A/600 V AC
- Suggested applications: heater or motor control

**NEW 77.E2.9.024.8671**



**Random switch-on**

- Output: 75 A/600 V AC
- Suggested applications: heater or motor control

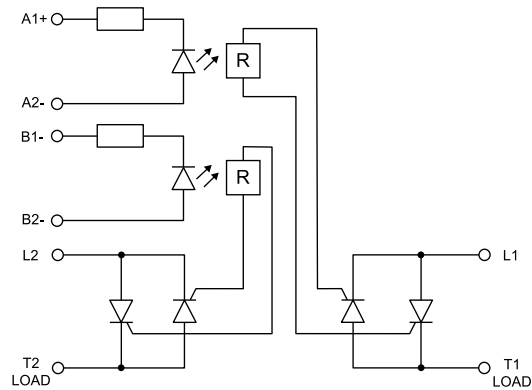

\* See L77-19, L77-20 and L77-21 diagrams page 20

For outline drawing see page 24

Simplified circuit diagram

Output specification			
Output configuration	2 NO	2 NO	2 NO
Rated current $I_N$ /Max. peak current (10 ms) A	25/300	50/500	75/750
Rated voltage V AC (50/60 Hz)	600	600	600
Switching voltage range V AC (50/60 Hz)	24...660	24...660	24...660
Repetitive peak off-state voltage $V_{pk}$	1200	1200	1200
Minimum switching current @ 600 V mA	—	—	—
Typical "OFF-state" leakage current @ rated voltage mA	5	5	5
Max "ON-state" voltage drop @ 25 °C and $I_N$ V	1.5	1.5	1.5
Power loss @ $I_N$ W	60	120	180
Input specification			
Nominal voltage ( $U_N$ ) V DC	24	24	24
Rated power @ $U_{MAX}$ W	0.3	0.3	0.3
Operating range V DC	4...32	4...32	4...32
Must drop-out voltage V AC (50/60 Hz)/DC	1	1	1
Technical data			
Electrical life cycles	—	—	—
Operate/release time ms	1/10	1/10	1/10
Insulation between input and output (1.2/50 $\mu$ s) kV	—	—	—
Ambient temperature °C	-30...+80*	-30...+80*	-30...+80*
Protection category	—	—	—
<b>Approvals</b> (according to type)			



**25 and 40 A three phase Random SSR, "hockey puck" style**

**Type 77.A3.x.xxx.8671:** 25 A - 600 V AC

**Type 77.B3.x.xxx.8671:** 40 A - 600 V AC

- High endurance and switching speed
- Silent switching
- Spark and bounce-free switching
- Low control power
- "contactor-style": input and output terminals on adjacent sides
- Mounting on control cabinet sheet metal or on heatsink

**NEW 77.A3.x.xxx.8671**



**Random switch-on**

- Output: 25 A/600 V AC
- Suggested applications: heater or motor control

**NEW 77.B3.x.xxx.8671**



**Random switch-on**

- Output: 40 A/600 V AC
- Suggested applications: heater or motor control

77.A3/B3  
Screw terminal (plate clamp)

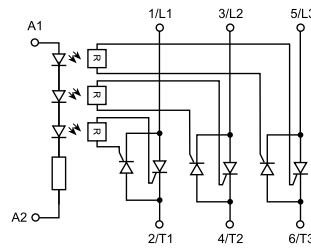

Simplified circuit diagram

\* See L77-22 and L77-23 diagrams page 20

For outline drawing see page 24

Output specification					
Output configuration		3 NO		3 NO	
Rated current $I_N$ /Max. peak current (10 ms)	A	25/300		40/500	
Rated voltage	V AC (50/60 Hz)	600		600	
Switching voltage range	V AC (50/60 Hz)	24...660		24...660	
Repetitive peak off-state voltage	$V_{pk}$	1600		1600	
Minimum switching current @ 600 V	mA	—		—	
Typical "OFF-state" leakage current @ rated voltage	mA	10		10	
Max "ON-state" voltage drop @ 25 °C and $I_N$	V	1.6		1.6	
Power loss @ $I_N$	W	90		144	
Input specification					
Nominal voltage ( $U_N$ )	V AC (50/60 Hz)	—	230	—	230
	V DC	24	—	24	—
Rated power @ $U_{MAX}$	VA (50 Hz)/W	—/0.55	5.3/—	—/0.55	5.3/—
Operating range	V AC (50/60 Hz)	—	90...280	—	90...280
	V DC	4...32	—	4...32	—
Must drop-out voltage	V AC (50/60 Hz)/DC	1	15	1	15
Technical data					
Electrical life	cycles	—		—	
Operate/release time	ms	1	10/20	1	10/20
Insulation between input and output (1.2/50 $\mu$ s)	kV	—		—	
Ambient temperature	°C	-30...+80*		-30...+80*	
Protection category		—		—	
<b>Approvals</b> (according to type)					



**60 and 80 A three phase Random SSR, "hockey puck" style**

**Type 77.D3.x.xxx.8671:** 60 A - 600 V AC

**Type 77.F3.x.xxx.8671:** 80 A - 600 V AC

- High endurance and switching speed
- Silent switching
- Spark and bounce-free switching
- Low control power
- "contactor-style": input and output terminals on adjacent sides
- Mounting on control cabinet sheet metal or on heatsink

**NEW 77.D3.x.xxx.8671**



**Random switch-on**

- Output: 60 A/600 V AC
- Suggested applications: heater or motor control

**NEW 77.F3.x.xxx.8671**



**Random switch-on**

- Output: 80 A/600 V AC
- Suggested applications: heater control

77.D3/F3

Screw terminal (plate clamp)

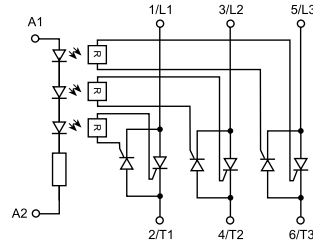

Simplified circuit diagram

\* See L77-24 and L77-25 diagrams page 20

For outline drawing see page 24

Output specification					
Output configuration		3 NO		3 NO	
Rated current $I_N$ /Max. peak current (10 ms)	A	60/700		80/1280	
Rated voltage	V AC (50/60 Hz)	600		600	
Switching voltage range	V AC (50/60 Hz)	24...660		24...660	
Repetitive peak off-state voltage	$V_{pk}$	1600		1600	
Minimum switching current @ 600 V	mA	—		—	
Typical "OFF-state" leakage current @ 600 V	mA	10		10	
Max "ON-state" voltage drop @ 25 °C and $I_N$	V	1.6		1.6	
Power loss @ $I_N$	W	216		288	
Input specification					
Nominal voltage ( $U_N$ )	V AC (50/60 Hz)	—	230	—	230
	V DC	24	—	24	—
Rated power @ $U_{MAX}$	VA (50 Hz)/W	—/0.55	5.3/—	—/0.55	5.3/—
Operating range	V AC (50/60 Hz)	—	90...280	—	90...280
	V DC	4...32	—	4...32	—
Must drop-out voltage	V AC (50/60 Hz)/DC	1	15	1	15
Technical data					
Electrical life	cycles	—		—	
Operate/release time	ms	1	10/20	1	10/20
Insulation between input and output (1.2/50 $\mu$ s)	kV	—		—	
Ambient temperature	°C	-30...+80*		-30...+80*	
Protection category		—		—	
<b>Approvals</b> (according to type)					

### Ordering information DIN rail SSR

Example: 77 series modular SSR, 1 output 30 A AC, input voltage 230 V AC, relay style terminals arrangement, zero-crossing switch-on.

	<b>7</b>	<b>7</b>	<b>.</b>	<b>3</b>	<b>.</b>	<b>1</b>	<b>.</b>	<b>8</b>	<b>.</b>	<b>2</b>	<b>3</b>	<b>0</b>	<b>.</b>	<b>A</b>	<b>B</b>	<b>C</b>	<b>D</b>	
														<b>8</b>	<b>0</b>	<b>5</b>	<b>0</b>	

<p><b>Series</b></p> <p><b>Type/rated current</b> 0 = 5/7/15 A output (77.01) 1 = 15 A output (77.11) 2 = 25 A output (77.21) 3 = 30 A output (77.31)</p> <p><b>No. of poles/mounting</b> 1 = 1 pole, modular housing (plastic or heat sink/plastic), DIN rail mounting</p> <p><b>Input version</b> 8 = AC (50/60 Hz) 9 = DC</p> <p><b>Supply voltage</b> See "input specification"</p> <p><b>Codes/Module width</b></p> <table border="0"> <tr> <td>77.01.8.230.8050/17.5 mm 5 A</td> <td>77.11.8.230.8250/22.5 mm 15 A</td> <td>77.21.8.230.8250/22.5 mm 25 A</td> <td>77.31.8.230.8050/22.5 mm 30 A</td> </tr> <tr> <td>77.01.9.024.8050/17.5 mm 5 A</td> <td>77.11.9.024.8250/22.5 mm 15 A</td> <td>77.21.9.024.8250/22.5 mm 25 A</td> <td>77.31.9.024.8050/22.5 mm 30 A</td> </tr> <tr> <td>77.01.8.230.8051/17.5 mm 5 A</td> <td>77.11.8.230.8251/22.5 mm 15 A</td> <td>77.21.8.230.8251/22.5 mm 25 A</td> <td>77.31.8.230.8051/22.5 mm 30 A</td> </tr> <tr> <td>77.01.9.024.8051/17.5 mm 5 A</td> <td>77.11.9.024.8251/22.5 mm 15 A</td> <td>77.21.9.024.8251/22.5 mm 25 A</td> <td>77.31.9.024.8051/22.5 mm 30 A</td> </tr> <tr> <td>77.01.9.024.9125/17.5 mm 7 A</td> <td></td> <td></td> <td>77.31.8.230.8070/22.5 mm 30 A</td> </tr> <tr> <td>77.01.9.024.9024/17.5 mm 15 A</td> <td></td> <td></td> <td>77.31.9.024.8070/22.5 mm 30 A</td> </tr> <tr> <td></td> <td></td> <td></td> <td>77.31.8.230.8071/22.5 mm 30 A</td> </tr> <tr> <td></td> <td></td> <td></td> <td>77.31.9.024.8071/22.5 mm 30 A</td> </tr> </table>	77.01.8.230.8050/17.5 mm 5 A	77.11.8.230.8250/22.5 mm 15 A	77.21.8.230.8250/22.5 mm 25 A	77.31.8.230.8050/22.5 mm 30 A	77.01.9.024.8050/17.5 mm 5 A	77.11.9.024.8250/22.5 mm 15 A	77.21.9.024.8250/22.5 mm 25 A	77.31.9.024.8050/22.5 mm 30 A	77.01.8.230.8051/17.5 mm 5 A	77.11.8.230.8251/22.5 mm 15 A	77.21.8.230.8251/22.5 mm 25 A	77.31.8.230.8051/22.5 mm 30 A	77.01.9.024.8051/17.5 mm 5 A	77.11.9.024.8251/22.5 mm 15 A	77.21.9.024.8251/22.5 mm 25 A	77.31.9.024.8051/22.5 mm 30 A	77.01.9.024.9125/17.5 mm 7 A			77.31.8.230.8070/22.5 mm 30 A	77.01.9.024.9024/17.5 mm 15 A			77.31.9.024.8070/22.5 mm 30 A				77.31.8.230.8071/22.5 mm 30 A				77.31.9.024.8071/22.5 mm 30 A	<p><b>D: Switch-on mode</b> 0 = Zero-crossing 1 = Random</p> <p><b>C: Terminals arrangement</b> 5 = "Relay style" (input and output on opposite sides) 7 = "Contactor style" (input and output on adjacent sides)</p> <p><b>AB: Output circuit</b> (rated voltage) 80 = 230 V AC (77.01), 400 V AC (77.31) 82 = 230 V AC (77.11, 77.21) 9024 = 24 V DC 9125 = 110...125 V DC</p>
77.01.8.230.8050/17.5 mm 5 A	77.11.8.230.8250/22.5 mm 15 A	77.21.8.230.8250/22.5 mm 25 A	77.31.8.230.8050/22.5 mm 30 A																														
77.01.9.024.8050/17.5 mm 5 A	77.11.9.024.8250/22.5 mm 15 A	77.21.9.024.8250/22.5 mm 25 A	77.31.9.024.8050/22.5 mm 30 A																														
77.01.8.230.8051/17.5 mm 5 A	77.11.8.230.8251/22.5 mm 15 A	77.21.8.230.8251/22.5 mm 25 A	77.31.8.230.8051/22.5 mm 30 A																														
77.01.9.024.8051/17.5 mm 5 A	77.11.9.024.8251/22.5 mm 15 A	77.21.9.024.8251/22.5 mm 25 A	77.31.9.024.8051/22.5 mm 30 A																														
77.01.9.024.9125/17.5 mm 7 A			77.31.8.230.8070/22.5 mm 30 A																														
77.01.9.024.9024/17.5 mm 15 A			77.31.9.024.8070/22.5 mm 30 A																														
			77.31.8.230.8071/22.5 mm 30 A																														
			77.31.9.024.8071/22.5 mm 30 A																														

### Ordering information hockey puck SSR

Example: 77 series modular SSR, 1 output 25 A AC, input voltage 230 V AC, relay style terminals arrangement, zero-crossing switch-on.

	<b>7</b>	<b>7</b>	<b>.</b>	<b>A</b>	<b>.</b>	<b>1</b>	<b>.</b>	<b>8</b>	<b>.</b>	<b>2</b>	<b>3</b>	<b>0</b>	<b>.</b>	<b>A</b>	<b>B</b>	<b>C</b>	<b>D</b>	
														<b>8</b>	<b>2</b>	<b>5</b>	<b>0</b>	

<p><b>Series</b></p> <p><b>Type/rated current</b> A = 25 A output B = 40 A output C = 50 A output D = 60 A output E = 75 A output F = 80 A output G = 100 A output H = 125 A output</p> <p><b>No. of poles/mounting</b> 1 = 1 phase, heat-sink or directly panel mounting ("hockey puck") 2 = 2 phases 3 = 3 phases</p> <p><b>Input version</b> 8 = AC (50/60 Hz) 9 = DC</p> <p><b>Supply voltage</b> See "input specification"</p> <p><b>Codes/Module width</b></p> <table border="0"> <tr> <td><b>1 phase 25 - 40 - 60 - 80 - 100 - 125 A</b></td> <td><b>2 phases 25 - 50 - 75 A</b></td> <td><b>3 phases 25 - 40 - 60 - 80 A</b></td> </tr> <tr> <td>77.x1.8.230.8250/"hockey puck"</td> <td>77.x2.9.024.8671/"hockey puck"</td> <td>77.x3.8.230.8671/"hockey puck"</td> </tr> <tr> <td>77.x1.9.024.8250/"hockey puck"</td> <td></td> <td>77.x3.9.024.8671/"hockey puck"</td> </tr> <tr> <td>77.x1.8.230.8650/"hockey puck"</td> <td></td> <td></td> </tr> <tr> <td>77.x1.9.024.8650/"hockey puck"</td> <td></td> <td></td> </tr> </table>	<b>1 phase 25 - 40 - 60 - 80 - 100 - 125 A</b>	<b>2 phases 25 - 50 - 75 A</b>	<b>3 phases 25 - 40 - 60 - 80 A</b>	77.x1.8.230.8250/"hockey puck"	77.x2.9.024.8671/"hockey puck"	77.x3.8.230.8671/"hockey puck"	77.x1.9.024.8250/"hockey puck"		77.x3.9.024.8671/"hockey puck"	77.x1.8.230.8650/"hockey puck"			77.x1.9.024.8650/"hockey puck"			<p><b>D: Switch-on mode</b> 0 = Zero-crossing 1 = Random</p> <p><b>C: Terminals arrangement</b> 5 = "Relay style" (input and output on opposite sides) 7 = "Contactor style" (input and output on adjacent sides)</p> <p><b>AB: Output circuit</b> (rated voltage) 82 = 230 V AC 86 = 600 V AC</p>
<b>1 phase 25 - 40 - 60 - 80 - 100 - 125 A</b>	<b>2 phases 25 - 50 - 75 A</b>	<b>3 phases 25 - 40 - 60 - 80 A</b>														
77.x1.8.230.8250/"hockey puck"	77.x2.9.024.8671/"hockey puck"	77.x3.8.230.8671/"hockey puck"														
77.x1.9.024.8250/"hockey puck"		77.x3.9.024.8671/"hockey puck"														
77.x1.8.230.8650/"hockey puck"																
77.x1.9.024.8650/"hockey puck"																

## Technical data

Insulation		77.01.8xxx		77.01.9xxx		77.11		77.21		77.31				
		Dielectric strength	Impulse (1.2/50 µs)	Dielectric strength	Impulse (1.2/50 µs)	Dielectric strength	Impulse (1.2/50 µs)	Dielectric strength	Impulse (1.2/50 µs)	Dielectric strength	Impulse (1.2/50 µs)			
Between input and output		2500 V AC	5 kV	3000 V AC	4 kV	3000 V AC	6 kV	3000 V AC	6 kV	3000 V AC	6 kV			
Between input and ground (heat-sink)		—	—	—	—	3000 V AC	6 kV	3000 V AC	6 kV	3000 V AC	6 kV			
Between output and ground (heat-sink)		—	—	—	—	2500 V AC	4 kV	2500 V AC	4 kV	4000 V AC	6 kV			
EMC specifications		Reference standard		77.01.8.230		77.01.9.024		77.11		77.21		77.31		
				230 V AC		24 V DC		24 V DC 230 V AC		24 V DC 230 V AC		24 V AC/DC 230 V AC		
Electrostatic discharge	contact discharge	EN 61000-4-2	4 kV	4 kV	4 kV	4 kV	4 kV	4 kV	4 kV	4 kV	4 kV	4 kV	4 kV	
	air discharge	EN 61000-4-2	8 kV	8 kV	8 kV	8 kV	8 kV	8 kV	8 kV	8 kV	8 kV	8 kV	8 kV	
Radiated electromagnetic field (80...1000 MHz)		EN 61000-4-3	30 V/m	20 V/m	20 V/m	20 V/m	20 V/m	20 V/m	20 V/m	20 V/m	20 V/m	20 V/m	30 V/m	
Fast transients on supply terminals (burst 5/50 ns, 5 and 100 kHz)		EN 61000-4-4	1 kV	1 kV	1 kV	3 kV	1 kV	3 kV	1 kV	3 kV	1 kV	3 kV	1 kV	
Voltage pulses on supply terminals (surge 1.2/50 µs)	common mode	EN 61000-4-5	—	—	—	3 kV	3 kV	3 kV	3 kV	3 kV	3 kV	3 kV	3 kV	
	differential mode	EN 61000-4-5	1 kV	0.5 kV	0.5 kV	1.5 kV	0.5 kV	1.5 kV	0.5 kV	1.5 kV	0.5 kV	1.5 kV	0.5 kV	
Radio-frequency common mode voltage (0.15...230 MHz) on supply terminals		EN 61000-4-6	10 V	10 V	10 V	10 V	10 V	10 V	10 V	10 V	10 V	10 V	10 V	
Terminals		77.01.x.xxx		77.01.9.xxx		77.11		77.21		77.31				
Screw torque		Nm	0.8	0.8	0.8	0.8	0.8	0.8	0.8	0.8	0.8	0.8	0.8	
Max. wire size			solid cable	stranded cable	solid cable	stranded cable	solid cable	stranded cable	solid cable	stranded cable	solid cable	stranded cable	solid cable	stranded cable
		mm <sup>2</sup>	1 x 6 / 2 x 4	1 x 4 / 2 x 25	1 x 6 / 2 x 4	1 x 4 / 2 x 25	1 x 6 / 2 x 4	1 x 6 / 2 x 4	1 x 6 / 2 x 4	1 x 6 / 2 x 4	1 x 6 / 2 x 4	1 x 6 / 2 x 4	1 x 6 / 2 x 4	1 x 6 / 2 x 4
		AWG	1x10/ 2x12	1x12/ 2x14	1x10/ 2x12	1x12/ 2x14	1x10/ 2x12	1x10/ 2x12	1x10/ 2x12	1x10/ 2x12	1x10/ 2x12	1x10/ 2x12	1x10/ 2x12	1x10/ 2x12
Wire strip length		mm	9		9		9		9		9		9	
Other data														
Power lost to the environment	without output current	W	0.5	0.5	0.5	0.9	0.9	0.9	0.9	0.9	0.9	0.9	0.9	
	with rated current	W	4.0	4.0	4.0	14	14	14	15	15	15	16	16	

		77.X1		77.X2		77.X3	
		Dielectric strength		Dielectric strength		Dielectric strength	
Between Input and output		4 kV		4 kV		4 kV	
Between input and ground (heat-sink)		4 kV		2.5 kV		2.5 kV	
Terminals							
Screw torque	Input side	Nm	1.5	0.5	0.5	0.5	0.5
	Output side	Nm	2.2	2.2	2.2	2.2	2.2
	On heatsink with thermal pad or paste	Nm	2.2	2.2	2.2	2.2	2.2

77.X1 wiring cross section area		
Load current (A)	Cross section area of wire (mm <sup>2</sup> )	Wire size (AWG)
15-20	2.5	12
20-35	4	10
25-32	6	10
32-50	10	8
50-65	16	6
65-85	25	4

Note: if the wire cross section area is bigger than 25 mm<sup>2</sup>, we suggest to use 2 smaller cross section wires and connect them back to back superimposed (in parallel).

## Input specification

### 77.01

Nominal voltage	Input code	Operating range				Must drop-out voltage (AC/DC)	Input current $I_N$ at $U_N$
		AC		DC			
		$U_{min}$	$U_{max}$	$U_{min}$	$U_{max}$		
$U_N$		V	V	V	V	V	mA
24	9.024	—	—	4	32	3.0	18
230	8.230	90	265	—	—	24	15

### 77.11/77.21

Nominal voltage	Input code	Operating range				Must drop-out voltage (AC/DC)	Input current $I_N$ at $U_N$
		AC		DC			
		$U_{min}$	$U_{max}$	$U_{min}$	$U_{max}$		
$U_N$		V	V	V	V	V	mA
24	9.024	—	—	4	32	2	11
230	8.230	40	305	—	—	6	25

### 77.31

Nominal voltage	Input code	Operating range				Must drop-out voltage (AC/DC)	Input current $I_N$ at $U_N$
		AC		DC			
		$U_{min}$	$U_{max}$	$U_{min}$	$U_{max}$		
$U_N$		V	V	V	V	V	mA
24	8.024	16	32	—	—	6	10
24	9.024	—	—	4	32	2	11
230	8.230	40	280	—	—	6	25

### 77.x1.x.xxx.8x50

Nominal voltage	Input code	Operating range				Must drop-out voltage (AC/DC)	Input current $I_N$ at $U_N$
		AC		DC			
		$U_{min}$	$U_{max}$	$U_{min}$	$U_{max}$		
$U_N$		V	V	V	V	V	mA
24	9.024	—	—	3	32	1.25	25
230	8.230	90	280	—	—	1.25	35



### 77.x2.9.024.8671



Nominal voltage	Input code	Operating range				Must drop-out voltage (AC/DC)	Input current $I_N$ at $U_N$
		AC		DC			
		$U_{min}$	$U_{max}$	$U_{min}$	$U_{max}$		
$U_N$		V	V	V	V	V	mA
24	9.024	—	—	4	32	1.5	25

### 77.x3.x.xxx.8671

Nominal voltage	Input code	Operating range				Must drop-out voltage (AC/DC)	Input current $I_N$ at $U_N$
		AC		DC			
		$U_{min}$	$U_{max}$	$U_{min}$	$U_{max}$		
$U_N$		V	V	V	V	V	mA
24	9.024	—	—	4	32	1.6	35
230	8.230	90	280	—	—	1.6	30

### Led indication

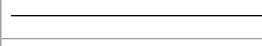
LED	Supply voltage
	OFF
	ON

LED (77.01.9.024.9xxx only)	Short circuit*
	NO
	YES

\*To restore normal operation it is necessary to disconnect the power, resolve the short circuit and then restore power.

## Output specification

**L77-1 Output RMS current v ambient temperature**  
77.01.9.024.805x @ 32 V DC

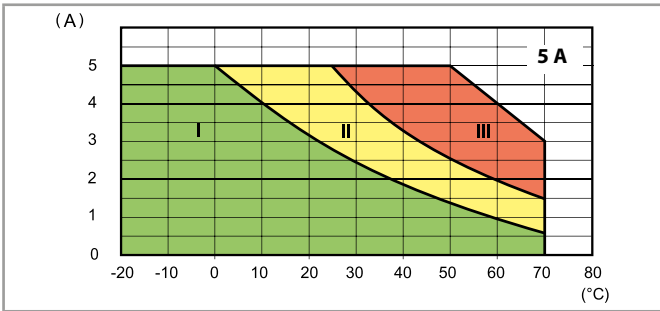

- I - Modular SSR installed as a group (without gap)
- II - Modular SSR installed as a group (9 mm gap between each SSR)
- III - Modular SSR installed individually in free air (without a significant influence from nearby components)

**L77-2 Output RMS current v ambient temperature**  
77.01.8.230.805x @ 265 V AC

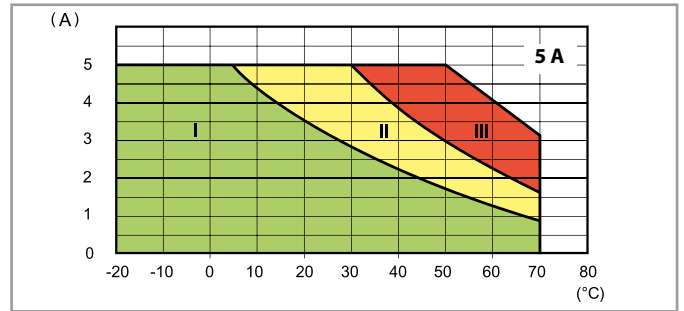

**L77-3 Output DC current v ambient temperature**  
77.01.9.024.9024 @ 32 V DC

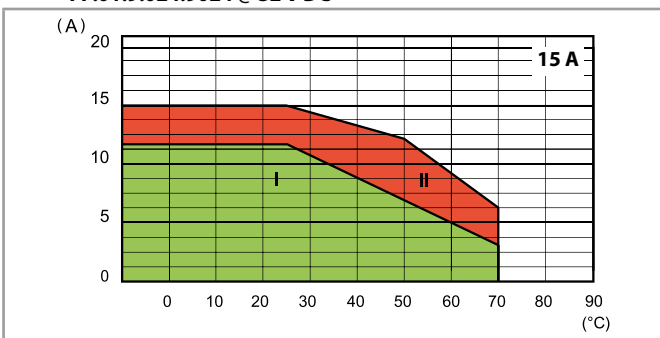

- I - Modular SSR installed as a group (without gap)
- II - Modular SSR installed individually in free air, or with a gap  $\geq 9$  mm, which implies a not significant influence from nearby components

**L77-4 Output DC current v ambient temperature**  
77.01.9.024.9125 @ 32 V DC

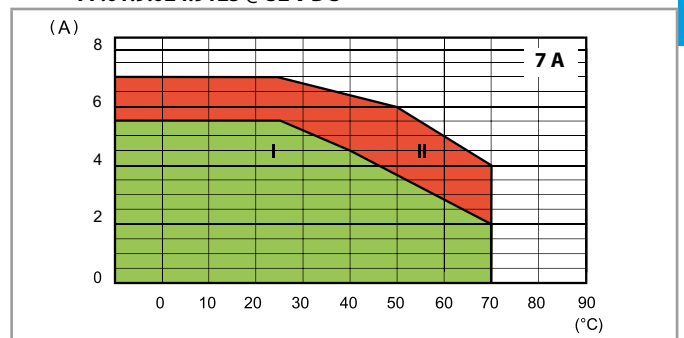

**L77-5 Output RMS current v ambient temperature**  
77.11.x.xxx.82xx

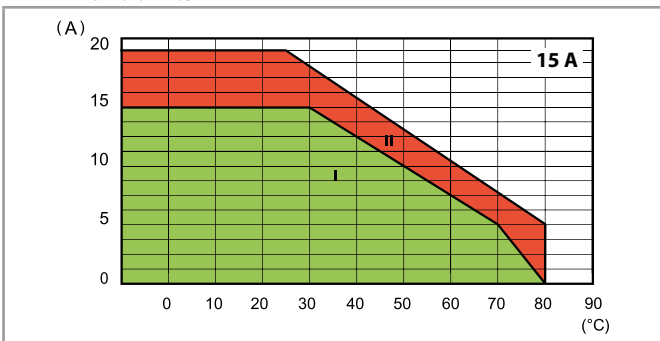

- I - Modular SSR installed as a group (without gap)
- II - Modular SSR installed individually in free air, or with a gap  $\geq 20$  mm, which implies a not significant influence from nearby components

**L77-6 Output RMS current v ambient temperature**  
77.21.x.xxx.825x

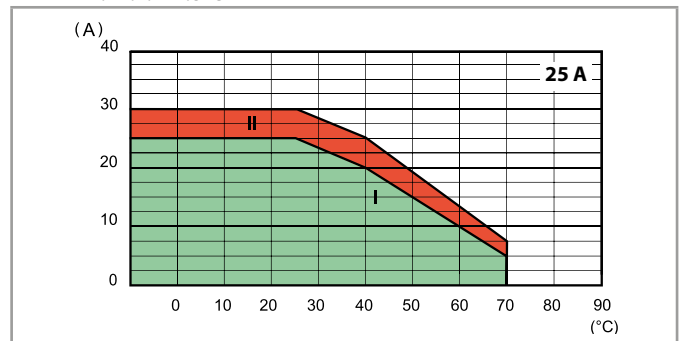

- I - Modular SSR installed as a group (without gap)
- II - Modular SSR installed individually in free air, or with a gap  $\geq 20$  mm, which implies a not significant influence from nearby components

**L77-7 Output RMS current v ambient temperature**  
77.31.x.xxx.80xx

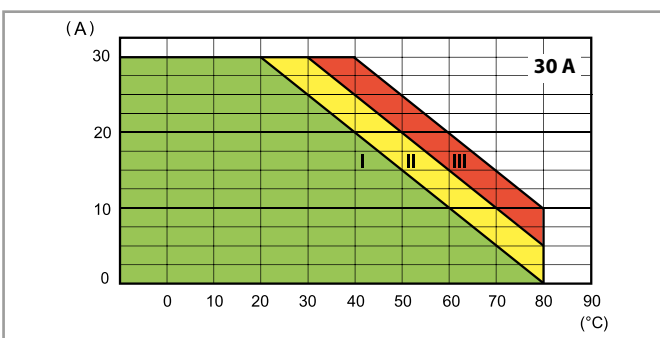

- I - Modular SSR installed as a group (without gap)
- II - Modular SSR installed as a group (20 mm gap between each SSR)
- III - Modular SSR installed individually in free air, or with a gap  $\geq 40$  mm, which implies a not significant influence from nearby components)

## Output specification

**L77-8 Inrush peak current (AC) v inrush time**  
77.01.x.xxx.80xx

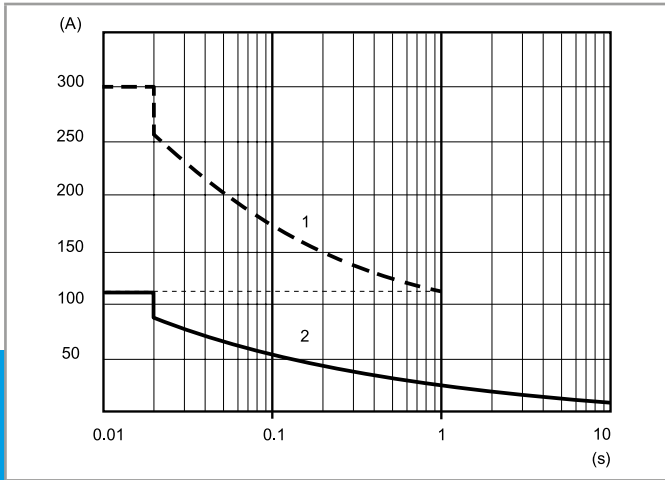

**L77-9 Inrush peak current (AC) v inrush time**  
77.11.x.xxx.82xx

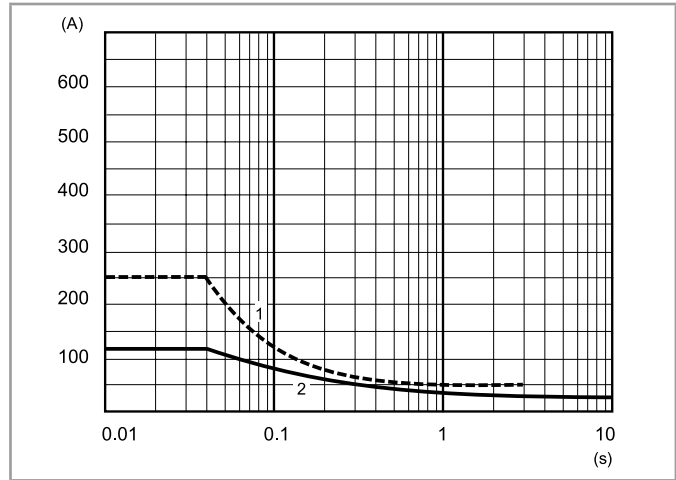

**L77-10 Inrush peak current (AC) v inrush time**  
77.21.x.xxx.825x

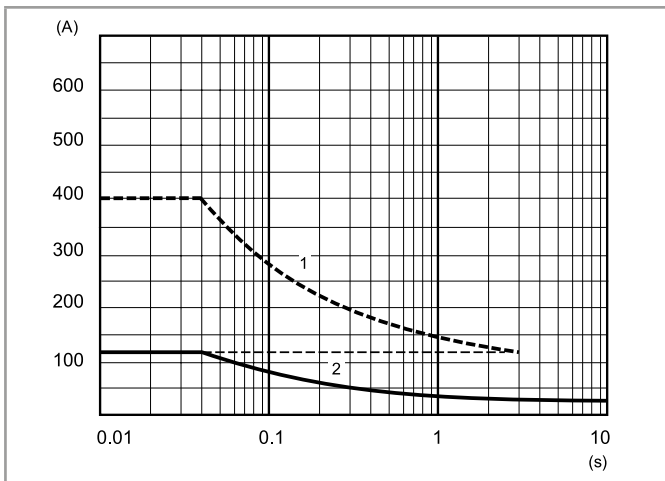

**L77-11 Inrush peak current (AC) v inrush time**  
77.31.x.xxx.80xx

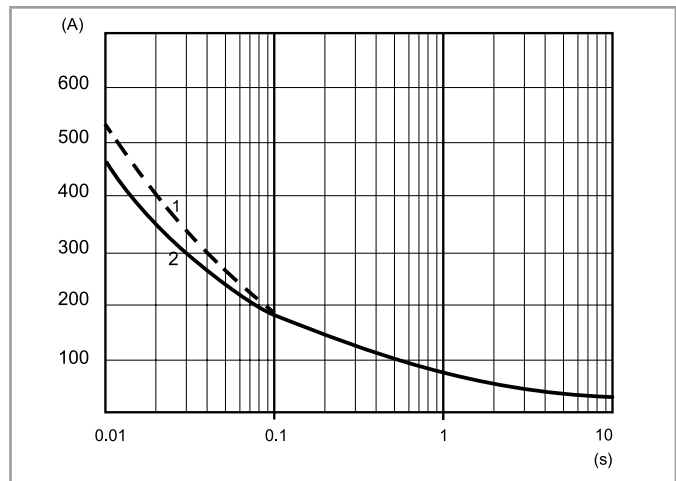

1 - "Cold" conditions (ambient temperature = 23 °C, no output current during the last 15 minutes)  
2 - "Hot" conditions (ambient temperature = 50 °C, rated output current)

## Output specification

**L77-13 Output RMS current v ambient temperature**  
**77.A1.x.xxx.8x50**

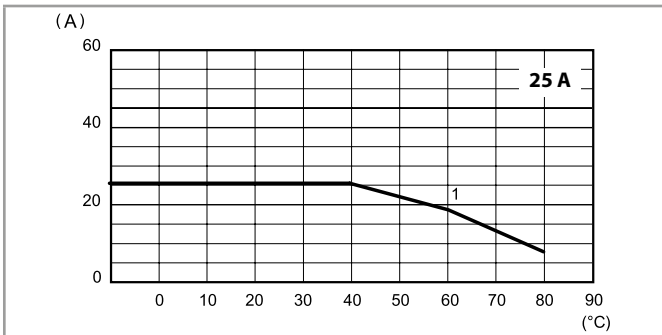

1 - Installation on heat-sink (2 K/W)

**L77-14 Output RMS current v ambient temperature**  
**77.B1.x.xxx.8x50**

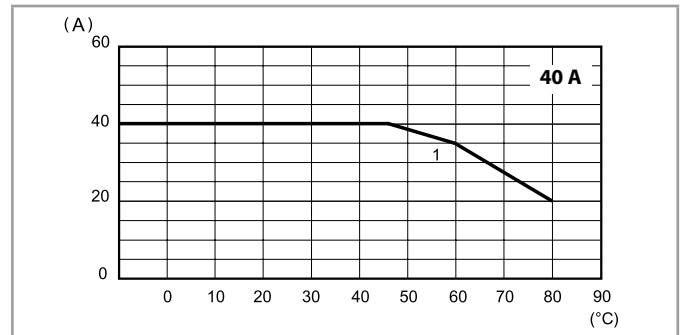

1 - Installation on heat-sink (0.9 K/W)

**L77-15 Output RMS current v ambient temperature**  
**77.D1.x.xxx.8x50**

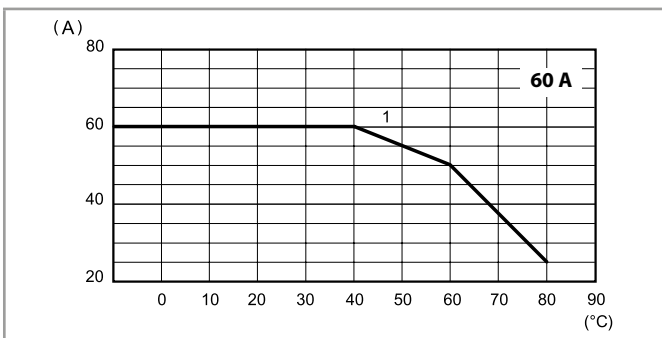

1 - Installation on heat-sink (0.7 K/W)

**L77-16 Output RMS current v ambient temperature**  
**77.F1.x.xxx.8x50**

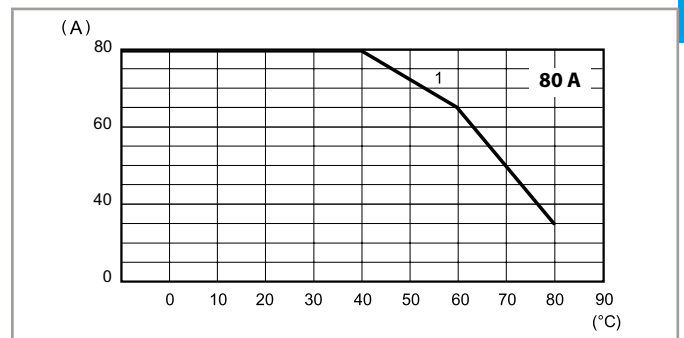

1 - Installation on heat-sink (0.5 K/W)

**L77-17 Output RMS current v ambient temperature**  
**77.G1.x.xxx.8x50**

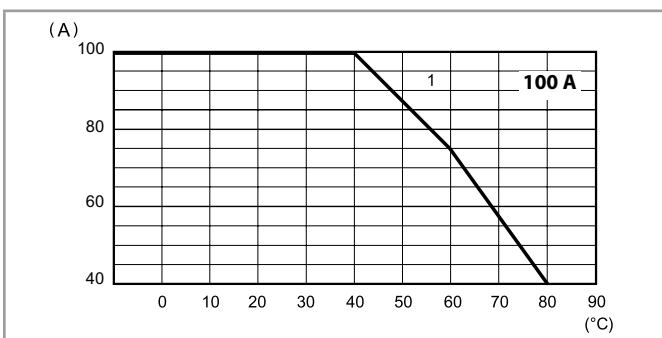

1 - Installation on heat-sink (0.45 K/W)

**L77-18 Output RMS current v ambient temperature**  
**77.H1.x.xxx.8x50**

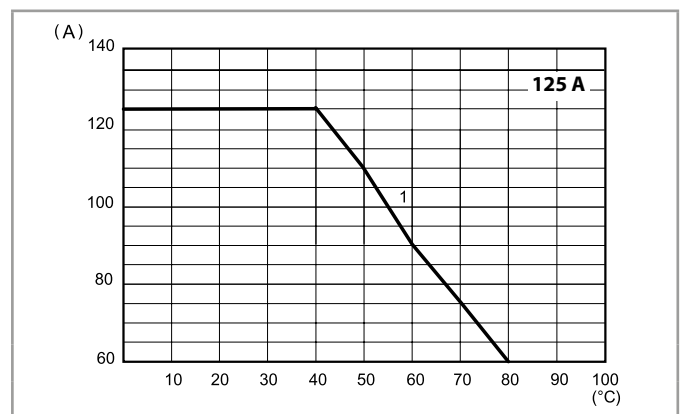

1 - Installation on heat-sink (0.35 K/W)

## Output specification

**L77-19 Output RMS current v ambient temperature**  
77.A2.9.024.8671

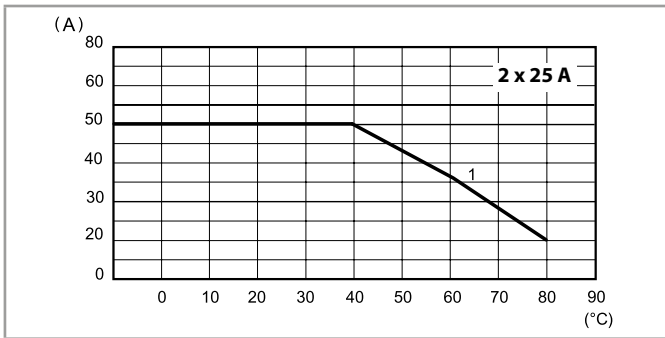

1 - Installation on heat-sink (0.9 K/W)

**L77-20 Output RMS current v ambient temperature**  
77.C2.9.024.8671

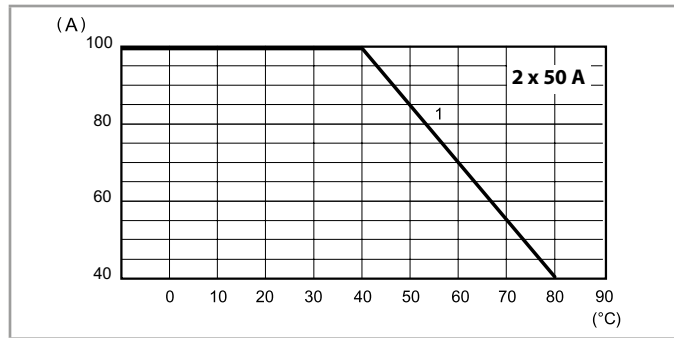

1 - Installation on heat-sink (0.45 K/W)

**L77-21 Output RMS current v ambient temperature**  
77.E2.9.024.8671

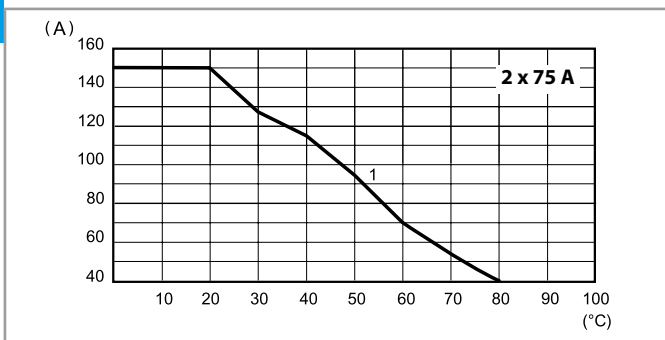

1 - Installation on heat-sink (0.45 K/W)

**L77-22 Output RMS current v ambient temperature**  
77.A3.x.xxx.8671

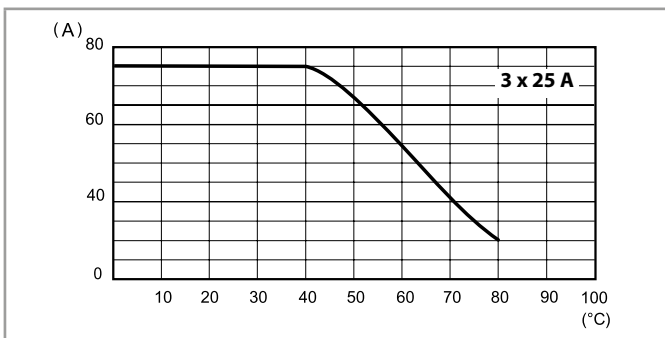

1 - Installation on heat-sink (0.7 K/W)

**L77-23 Output RMS current v ambient temperature**  
77.B3.x.xxx.8671

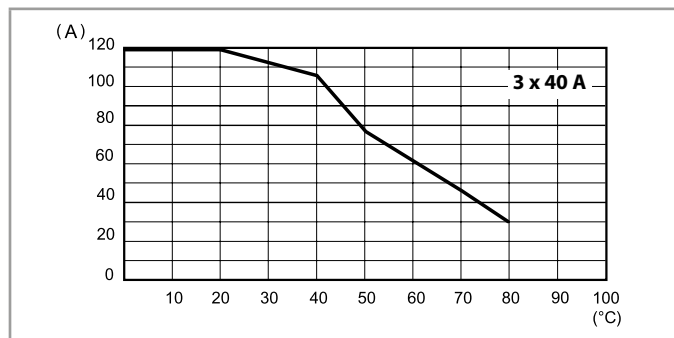

1 - Installation on heat-sink (0.5 K/W)

**L77-24 Output RMS current v ambient temperature**  
77.D3.x.xxx.8671

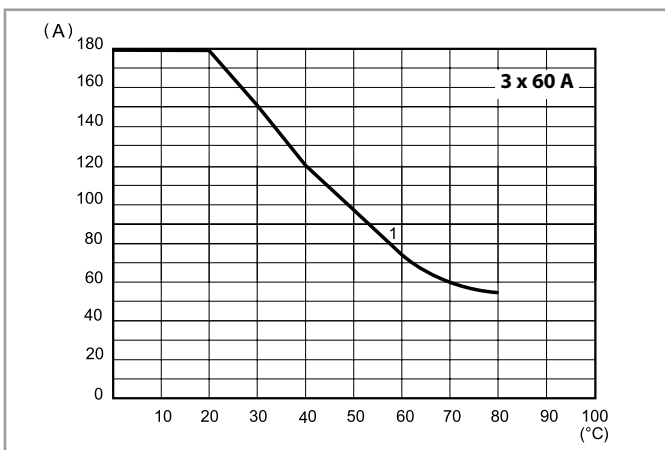

1 - Installation on heat-sink (0.45 K/W)

**L77-25 Output RMS current v ambient temperature**  
77.F3.x.xxx.8671

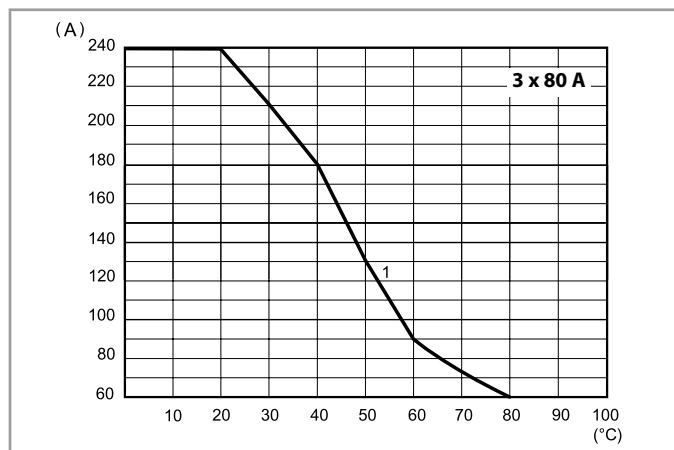

1 - Installation on heat-sink (0.35 K/W)



## Output specification

Max recommended switching frequency (Cycles/Hour, with 50% Duty-cycle)				
Load	77.01.9xxx	77.01.9xxx	77.11/21	77.31
5 A 230 V (AC1)	5000	—	—	—
5 A 24 V DC L/R = 20 ms	—	3600	—	—
1 A (AC15)	10000	—	—	—
0.5 A (AC15)	20000	—	—	—
15 A 305 V cos φ = 0.8	—	—	1800	—
15 A 305 V cos φ = 0.5	—	—	1200	—
30 A 480 V cos φ = 0.8	—	—	—	1800
30 A 480 V cos φ = 0.5	—	—	—	1200
25 A 230 V cos φ = 0.7	—	—	—	—
40 A 230 V cos φ = 0.7	—	—	—	—
50 A 230 V cos φ = 0.7	—	—	—	—

Other data				
	77.01.8xxx	77.01.9xxx	77.11/21	77.31
<b>Critical rising voltage</b> dv/dt without input control (gate open) @ T <sub>j</sub> = 125 °C	> 1000 V/μs	> 1000 V/μs	> 500 V/μs > 10 V/μs (with di/dt = 20 A/ms)	> 1000 V/μs
<b>Critical rising current</b> di/dt @ T <sub>j</sub> = 125 °C	> 50 A/μs	> 50 A/μs	> 50 A/μs	> 150 A/μs
<b>I<sup>2</sup>t for fusing</b> @ t <sub>p</sub> = 10 ms	450 A <sup>2</sup> s	450 A <sup>2</sup> s	1000 A <sup>2</sup> s*	1350 A <sup>2</sup> s**

Suggested fuse (depending on application) for short-circuit protection (Ultra-Fast acting types for semiconductors):

\* 20 A, 660 V AC, 10 x 38 mm, 200 kA, 360 A<sup>2</sup>s.

\*\* 30 A, 660 V AC, 10 x 38 mm, 200 kA, 1000 A<sup>2</sup>s.

Max recommended switching frequency (Cycles/Hour, with 50% Duty-cycle)						
Load	77.A1.x.xxx	77.B1.x.xxx	77.D1.x.xxx	77.F1.x.xxx	77.G1.x.xxx	77.H1.x.xxx
25 A 230 V cos φ = 0.7	1800	—	—	—	—	—
40 A 230 V cos φ = 0.7	—	1800	—	—	—	—
60 A 230 V cos φ = 0.7	—	—	1800	—	—	—
80 A 230 V cos φ = 0.7	—	—	—	1800	—	—
100 A 230 V cos φ = 0.7	—	—	—	—	1800	—
125 A 230 V cos φ = 0.7	—	—	—	—	—	1800

Other data						
	77.A1.x.xxx	77.B1.x.xxx	77.D1.x.xxx	77.F1.x.xxx	77.G1.x.xxx	77.H1.x.xxx
<b>Critical rising voltage</b> dv/dt without input control (gate open) @ T <sub>j</sub> = 125 °C	500 V/μs	500 V/μs	500 V/μs	500 V/μs	500 V/μs	500 V/μs
<b>I<sup>2</sup>t for fusing</b> @ t <sub>p</sub> = 10 ms	450 A <sup>2</sup> s	1250 A <sup>2</sup> s	2450 A <sup>2</sup> s*	3200 A <sup>2</sup> s**	11 250 A <sup>2</sup> s	25 000 A <sup>2</sup> s

Max recommended switching frequency (Cycles/Hour, with 50% Duty-cycle)			
Load	77.A2.x.xxx	77.C2.x.xxx	77.E2.x.xxx
25 A 230 V cos φ = 0.7	1800	—	—
50 A 230 V cos φ = 0.7	—	1800	—
75 A 230 V cos φ = 0.7	—	—	1800

Other data			
	77.A2.x.xxx	77.C2.x.xxx	77.E2.x.xxx
<b>Critical rising voltage</b> dv/dt without input control (gate open) @ T <sub>j</sub> = 125 °C	500 V/μs	500 V/μs	500 V/μs
<b>I<sup>2</sup>t for fusing</b> @ t <sub>p</sub> = 10 ms	450 A <sup>2</sup> s	2110 A <sup>2</sup> s	2810 A <sup>2</sup> s*

Max recommended switching frequency (Cycles/Hour, with 50% Duty-cycle)				
Load	77.A3.x.xxx	77.B3.x.xxx	77.D3.x.xxx	77.F3.x.xxx
25 A 230 V cos φ = 0.7	1800	—	—	—
40 A 230 V cos φ = 0.7	—	1800	—	—
60 A 230 V cos φ = 0.7	—	—	1800	—
80 A 230 V cos φ = 0.7	—	—	—	1800

Other data				
	77.A3.x.xxx	77.B3.x.xxx	77.D3.x.xxx	77.F3.x.xxx
<b>Critical rising voltage</b> dv/dt without input control (gate open) @ T <sub>j</sub> = 125 °C	500 V/μs	500 V/μs	500 V/μs	500 V/μs
<b>I<sup>2</sup>t for fusing</b> @ t <sub>p</sub> = 10 ms	450 A <sup>2</sup> s	1250 A <sup>2</sup> s	2450 A <sup>2</sup> s*	8190 A <sup>2</sup> s**

Wiring diagrams

Single-phase connection  
(77.01...802x)

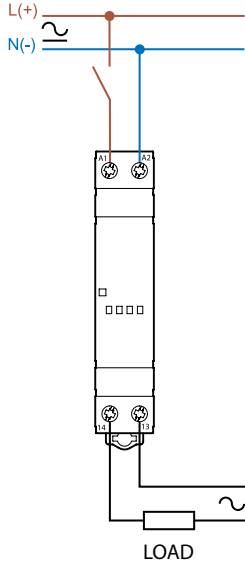

Single-phase connection DC  
(77.01...9x2x)

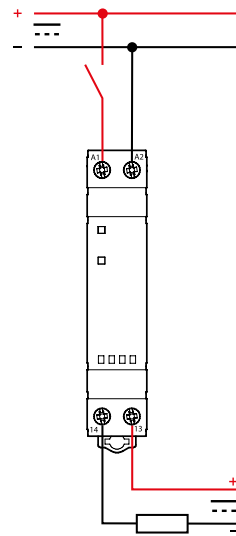

Single-phase connection  
(77.11/77.21)

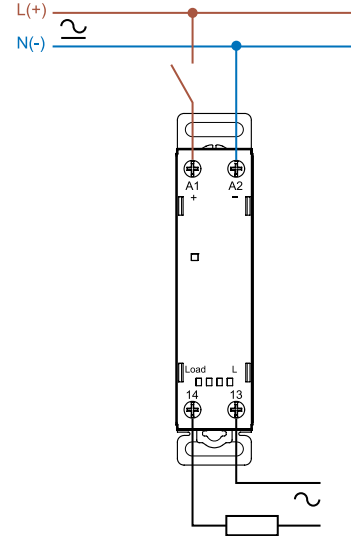

Single-phase connection  
(77.31...805x)

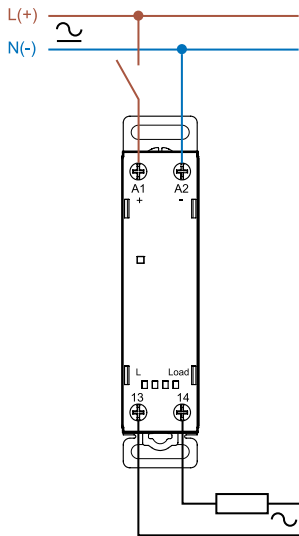

Single-phase connection  
(77.31...807x)

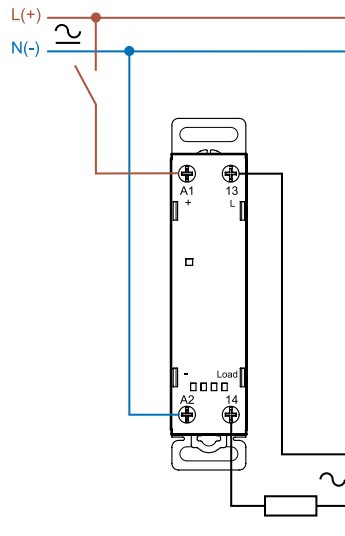

Example of three-phase connection  
(with 3 x 77.01)

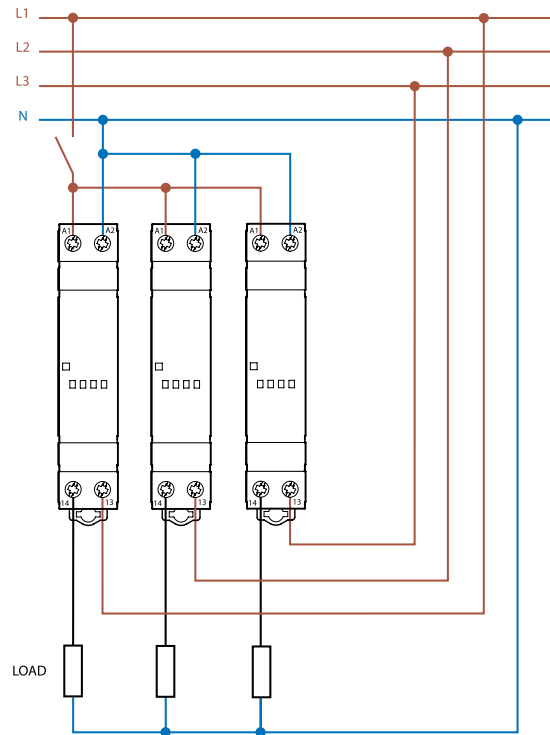

Note: this connection can be used with all 77 series types.

D

Wiring diagrams

Single-phase connection  
(77.x1)

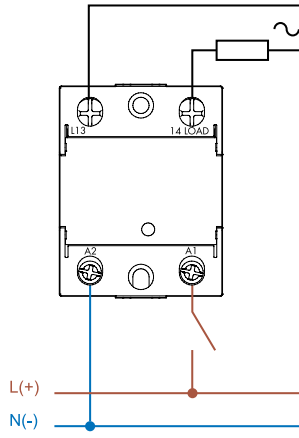

Dual phase connection  
(77.x2)

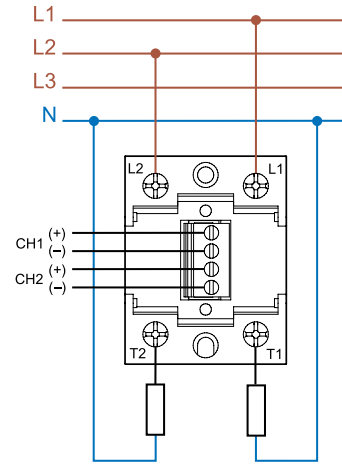

Three phase connection  
(77.x3)

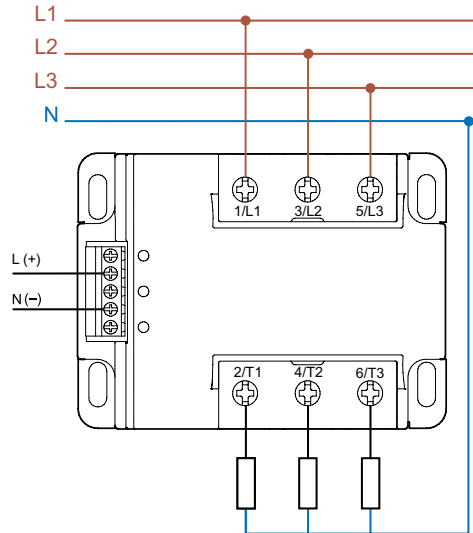

D

### Outline drawings

Type 77.01  
Screw terminal

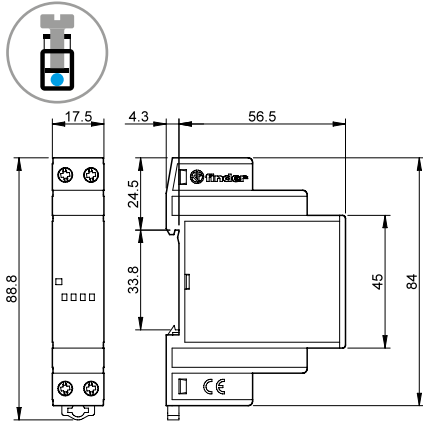

Types 77.11/21/31  
Screw terminal

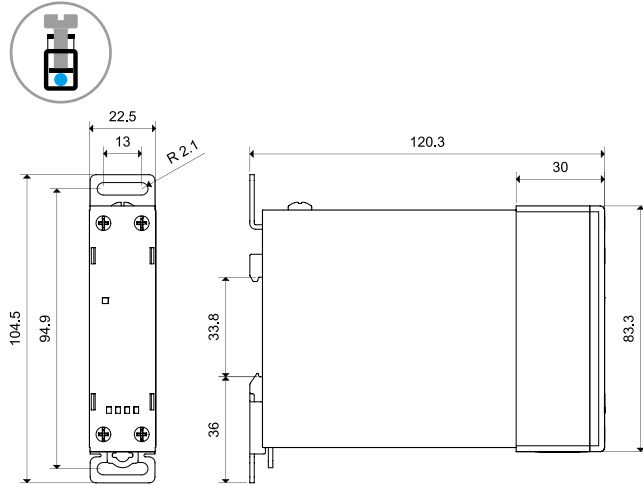

Type 77.01 DC  
Screw terminal

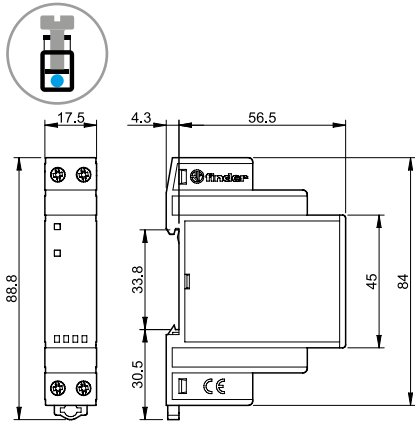

Type 77.x1  
Screw terminal (plate clamp)

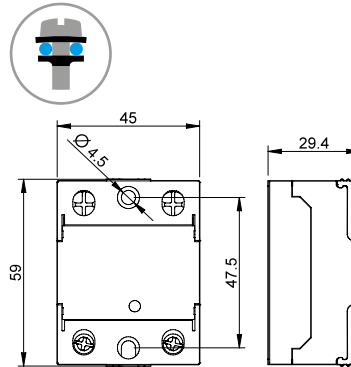

Type 77.x2  
Screw terminal (plate clamp)

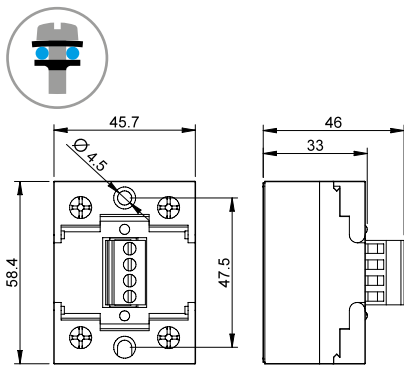

Type 77.x3  
Screw terminal (plate clamp)

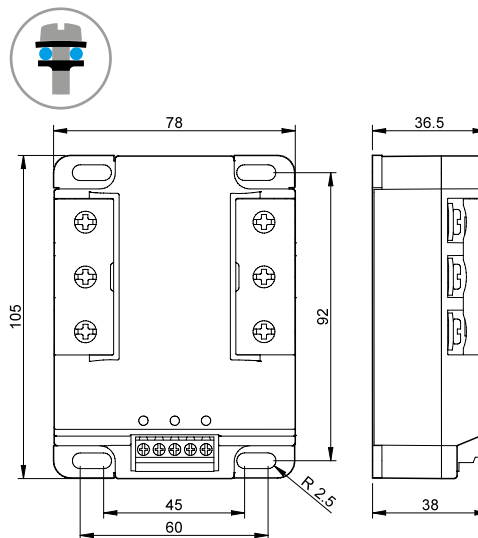

D

Accessories



020.01

**Adaptor for panel mounting**, plastic, 17.5 mm wide for 77.01 only

020.01

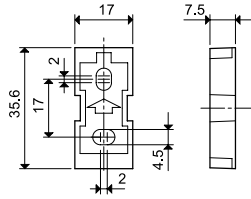

022.09

**Separator for rail mounting**, plastic, 9 mm wide

022.09

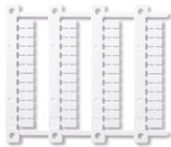
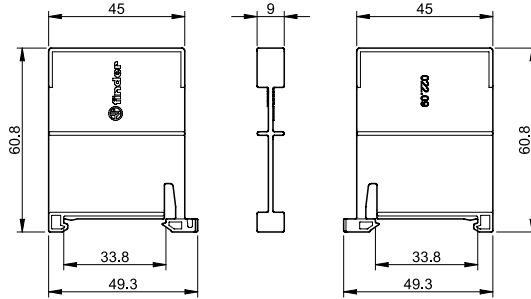

060.48

**Sheet of marker tags (CEMBRE Thermal transfer printers)** for all relays (48 tags), 6 x 12 mm

060.48



# Monitoring relays

70  
SERIES



Air  
conditioners



Wood-  
processing  
machines



Hoists and  
cranes



Escalators



Control panels  
for pumps



Forced-air  
ventilators







**Electronic voltage monitoring relays for single and three-phase applications**

- Multifunctional types, providing the flexibility of monitoring Undervoltage, Overvoltage, Window Mode, Phase rotation, Phase loss
- Positive safety logic - Make output contact opens if the relay detects an error
- All functions and values can be easily adjusted by the selector and trimmer on front face
- "Blade + cross" – both flat blade and cross head screw drivers can be used to adjust the regulators and the function selector
- Colored LEDs for clear & immediate visual indication
- 1 CO relay output, 6 or 10 A
- Modular housing, 17.5 or 35 mm wide
- 35 mm rail (EN 60715) mount
- Cd-free contact material

Screw terminal



For outline drawing see page 16

**Contact specification**

Contact configuration		1 CO (SPDT)	1 CO (SPDT)
Rated current/Maximum peak current	A	10/30	6/10
Rated voltage/ Max. switching voltage	V AC	250/400	250/400
Rated load AC1	VA	2500	1500
Rated load AC15	VA	750	500
Single phase motor rating (230 V AC)	kW	0.5	0.185
Breaking capacity DC1: 24/110/220 V	A	10/0.3/0.12	6/0.2/0.12
Minimum switching load	mW (V/mA)	300 (5/5)	500 (12/10)
Standard contact material		AgNi	AgNi

**Supply specification**

Nominal system voltage (U <sub>N</sub> )	V AC (50/60 Hz)	220...240	380...415
Rated power	VA (50 Hz)/W	2.6/0.8	11/0.9
Operating range	V AC (50/60 Hz)	130...280	220...510

**Technical data**

Electrical life at rated load AC1	cycles	80 · 10 <sup>3</sup>	60 · 10 <sup>3</sup>
Voltage detection level range	V	170...270	300...480
Asymmetry detection level range	%	—	—
Switch-off delay time (T on function diagrams)	s	0.5...60	0.5...60
Switch-on lock-out time	s	0.5	1
Switch-on hysteresis (H on function diagrams)	V	5 (L-N)	10 (L-L)
Power-on activation time	s	≈ 1	≈ 1
Insulation between supply and contacts (1.2/50 μs)	kV	4	4
Dielectric strength between open contacts	V AC	1000	1000
Ambient temperature	°C	-20...+60	-20...+60
Protection category		IP 20	IP 20

**Approvals** (according to type)



**70.11**



Single-phase (220...240)V voltage monitoring:

- Undervoltage
- Overvoltage
- Window mode (overvoltage + undervoltage)
- Voltage fault memory selectable

**70.31**



Three-phase (380...415)V voltage monitoring:

- Undervoltage
- Overvoltage
- Window mode (overvoltage + undervoltage)
- Voltage fault memory selectable
- Phase loss, even under phase regeneration
- Phase rotation

**Electronic voltage monitoring relays for three-phase applications**

- Multifunctional types, providing the flexibility of monitoring Undervoltage, Overvoltage, Window Mode, Phase rotation, Phase loss, Asymmetry and Neutral loss
- Phase loss monitoring, even under phase regeneration
- Positive safety logic - Make output contact opens if the relay detects an error
- All functions and values can be easily adjusted by the selector and trimmer on front face
- "Blade + cross" – both flat blade and cross head screw drivers can be used to adjust the regulators and the function selector
- Colored LEDs for clear & immediate visual indication
- 1 or 2 CO relay output, 6 or 8 A
- Modular housing, 35 mm wide
- 35 mm rail (EN 60715) mount
- Cd-free contact material

Screw terminal



For outline drawing see page 16

**Contact specification**

		70.41	70.42
Contact configuration		1 CO (SPDT)	2 CO (DPDT)
Rated current/Maximum peak current	A	6/10	8/15
Rated voltage/ Max. switching voltage	V AC	250/400	250/400
Rated load AC1	VA	1500	2000
Rated load AC15	VA	500	400
Single phase motor rating (230 V AC)	kW	0.185	0.3
Breaking capacity DC1: 24/110/220 V	A	6/0.2/0.12	8/0.3/0.12
Minimum switching load	mW (V/mA)	500 (12/10)	300 (5/5)
Standard contact material		AgNi	AgNi

**Supply specification**

		70.41	70.42
Nominal system voltage ( $U_N$ )	V AC (50/60 Hz)	380...415	380...415
Rated power	VA (50 Hz)/W	11/0.9	12.5/1
Operating range	V AC (50/60 Hz)	220...510	220...510

**Technical data**

		70.41	70.42
Electrical life at rated load AC1	cycles	$60 \cdot 10^3$	$60 \cdot 10^3$
Voltage detection level range	V	300...480	300...480
Asymmetry detection level range	%	4...25	5...25
Switch-off delay time (T on function diagrams)	s	0.5...60	0.5...60
Switch-on lock-out time	s	1	1
Switch-on hysteresis (H on function diagrams)	V	10 (L-L)	10 (L-L)
Power-on activation time	s	$\approx 1$	$\approx 1$
Insulation between supply and contacts (1.2/50 $\mu$ s)	kV	4	4
Dielectric strength between open contacts	V AC	1000	1000
Ambient temperature	$^{\circ}$ C	-20...+60	-20...+60
Protection category		IP 20	IP 20

**Approvals** (according to type)

**70.41**

Three-phase (380...415 V, with or without neutral) voltage monitoring:

- Window mode (overvoltage + undervoltage)
- Phase loss
- Phase rotation
- Asymmetry
- Neutral loss selectable

**70.42**

Three-phase (380...415 V, with neutral) voltage monitoring:

- Undervoltage
- Overvoltage
- Window mode (overvoltage + undervoltage)
- Voltage fault memory selectable
- Phase loss
- Phase rotation
- Asymmetry
- Neutral loss

**Universal current detecting and monitoring relays**

**Type 70.51.0.240.2032**

- Current Control standard version

**Type 70.51.0.240.N032**

- Current Control Programmable via NFC version

Multifunctional type, providing the flexibility of monitoring Undercurrent, Overcurrent and Window Mode

- Positive safety logic - Make output contact opens if the relay detects an error
- All functions and values can be easily adjusted by the selector and trimmer on front face (70.51.0.240.2032) OR via NFC toolbox APP (70.51.0.240.N032)
- "Blade + cross" –both flat blade and cross head screw drivers can be used to adjust the regulators and the function selector
- Colored LED for clear & immediate visual indication
- 1 CO 10 A relay output
- Modular housing, 35 mm wide

Screw Terminal



For outline drawing see page 16

**NEW 70.51.0.240.2032**



- 6 Functions universal current monitoring relay
- AC/DC current detection 50 mA...16 A
- Fault memory selectable
- Switch-on hysteresis (5...50)% (1...99% in Window Mode)

**NEW 70.51.0.240.N032**



- 6 Functions universal current monitoring relay
- AC/DC current detection 50 mA...16 A
- Programmable via Toolbox NFC app

**Contact specification**

Contact configuration		1 CO (SPDT)
Rated current/Maximum peak current	A	10/15
Rated voltage/Maximum switching voltage	V AC	250/400
Rated load AC1	VA	2500
Rated load AC15 (230 V AC)	VA	500
Single phase motor rating (230 V AC)	kW	0.5
Breaking capacity DC1: 24/110/220 V	A	10/0.3/0.12
Minimum switching load	mW (V/mA)	300 (5/5)
Standard contact material		AgSnO <sub>2</sub>

**Supply specification**

Nominal voltage (U <sub>N</sub> )	V AC (50/60 Hz)	24...240
	V DC	24...240
Rated power AC/DC	VA (50 Hz)/W	2.5/0.53
Operating range	AC	(0.8...1.1)U <sub>N</sub>
	DC	(0.8...1.1)U <sub>N</sub>

**Technical data**

Electrical life at rated load AC1	cycles	100 · 10 <sup>3</sup>
Detection levels	AC(50/60 Hz)/DC	50 mA...16 A
Switch-on lock-out time (T1 on function diagrams)	s	0.1...40
Switch-on hysteresis (H on function diagrams)	%	5...50 (1...99 in Window Mode)
Switch-off delay time (T2 on function diagrams)	s	0.1...30
Electrical isolation: Supply to Measuring circuits		Yes
Ambient temperature range	°C	-20...+55
Protection category		IP 20

**Approvals** (according to type)



**Electronic phase loss and rotation monitoring relays for three-phase applications**

- Universal voltage monitoring ( $U_N$  from 208 V to 480 V, 50/60 Hz)
- Phase loss monitoring, even under phase regeneration
- Positive safety logic - Make contact opens if the relay detects an error
- 2 versions:
  - 1 CO relay output, 6 A (17.5 mm wide), and
  - 2 CO relay output, 8 A (22.5 mm wide)
- 35 mm rail (EN 60715) mount
- European patent pending for the innovative principle at the root of the 3 phase monitoring and error survey system (70.61)

 70.61  
Screw terminal

 70.61-P000  
Push-in terminal

**NEW 70.61/70.61-P000**

 Three-phase (208...480)V  
voltage monitoring:

- Phase loss
- Phase rotation







**70.62**

 Three-phase (208...480)V  
voltage monitoring:

- Phase loss
- Phase rotation

For outline drawing see page 17

**Contact specification**

		70.61/70.61-P000	70.62
Contact configuration		1 CO (SPDT)	2 CO (DPDT)
Rated current/Maximum peak current	A	6/15	8/15
Rated voltage/ Max. switching voltage	V AC	250/400	250/400
Rated load AC1	VA	1500	2000
Rated load AC15	VA	250	400
Single phase motor rating (230 V AC)	kW	0.185	0.3
Breaking capacity DC1: 24/110/220 V	A	3/0.35/0.2	8/0.3/0.12
Minimum switching load	mW (V/mA)	500 (10/5)	300 (5/5)
Standard contact material		AgSnO <sub>2</sub>	AgNi
<b>Supply specification</b>			
Nominal system voltage ( $U_N$ )	V AC (50/60 Hz)	208...480	208...480
Rated power	VA (50 Hz)/W	8/1	11/0.8
Operating range	V AC (50/60 Hz)	170...500	170...520
<b>Technical data</b>			
Electrical life at rated load AC1	cycles	100 · 10 <sup>3</sup>	60 · 10 <sup>3</sup>
Switch-off delay time	s	0.5	0.5
Switch-on lock-out time	s	0.5	0.5
Power-on activation time	s	< 2	< 2
Insulation between supply and contacts (1.2/50 μs)	kV	5	5
Dielectric strength between open contacts	V AC	1000	1000
Ambient temperature	°C	-20...+60	-20...+60
Protection category		IP 20	IP 20
<b>Approvals</b> (according to type)		   	  

**Thermistor temperature sensing relays for industrial application**

- Temperature detection with PTC
- PTC short circuit detection
- PTC wire breakage detection
- Positive safety logic - Make contact opens if the relay detects an error
- Fault memory selectable
- LED status indication
- 35 mm rail (EN 60715) mounting

Screw Terminal



**NEW** 70.92.x.xxx.0002



- 6 functions
- RESET delay time (0.5s or 3s) selectable
- RESET terminals

For outline drawing see page 17

Contact specification		
Contact configuration		2 CO (DPDT)
Rated current/Maximum peak current	A	8 /15
Rated voltage/ Maximum switching voltage	V AC	250/400
Rated load AC1	VA	2000
Rated load AC15 (230 V AC)	VA	400
Single phase motor rating (230 V AC)	kW	0.3
Breaking capacity DC1: 24/110/220 V	A	8/0.3/0.12
Minimum switching load	mW (V/mA)	300 (5/5)
Standard contact material		AgNi
Supply specification		
Nominal voltage (U <sub>N</sub> )	V AC (50/60 Hz)	230
	V AC/DC	24
Rated power AC/DC	VA (50 Hz)/W	1/0.5
Operating range	AC	184...253
	AC/DC	19.2...26.4
Technical data		
Electrical life at rated load AC1	cycles	100 · 10 <sup>3</sup>
PTC detecting:	Short circuit/Temperature OK	<20 Ω/>20 Ω...<3 kΩ
	RESET/PTC break	< 1.3 kΩ / > 3 kΩ
RESET delay time	s	0.5 or 3
Ambient temperature range	°C	-20...+55
Protection category		IP 20
Approvals (according to type)		<b>CE UK EAC</b>



## Technical data

Insulation			70.11/31/41/42	70.51	70.61	70.62/92
Between supply and contacts	dielectric strength	V AC	2500	2500	2500	3000
	impulse (1.2/50 µs)	kV	4	4	5	5
Between open contacts	dielectric strength	V AC	1000	1000	1000	1000
	impulse (1.2/50 µs)	kV	1.5	1.5	1.5	1.5
EMC specifications						
Type of test			Reference standard			
Electrostatic discharge	contact discharge		EN 61000-4-2		4 kV	
	air discharge		EN 61000-4-2		8 kV	
Radiated electromagnetic field	80...1000 MHz		EN 61000-4-3		10 V/m	
	1...2.8 GHz		EN 61000-4-3		5 V/m	
Fast transients (burst 5/50 ns, 5 and 100 kHz)	on supply terminals		EN 61000-4-4		4 kV	
Voltage pulses on supply terminals (surge 1.2/50 µs)	common mode		EN 61000-4-5		4 kV	
	differential mode		EN 61000-4-5		4 kV	
Radiofrequency common mode voltage (0.15...230 MHz)	on supply terminals		EN 61000-4-6		10 V	
Voltage dips	70% U <sub>N</sub>		EN 61000-4-11		25 cycles	
Short interruptions			EN 61000-4-11		1 cycle	
Radiofrequency conducted emissions	0.15...30 MHz		CISPR 11		class B	
Radiated emissions	30...1000 MHz		CISPR 11		class B	
Terminals			Screw terminals		Push-in terminals	
Wire strip length	mm		10		10	
Screw torque	Nm		0.8		—	
Min. wire size			Solid cable		Solid cable	
	mm <sup>2</sup>		0.5		0.75	
	AWG		20		18	
Max. wire size			Solid cable		Solid cable	
	mm <sup>2</sup>		1 x 6 / 2 x 4		1 x 1.5 / 2 x 1.5	
	AWG		1 x 10 / 2 x 12		1 x 16 / 2 x 16	
Min. wire size			Stranded cable		Stranded cable	
	mm <sup>2</sup>		0.5		0.75	
	AWG		20		18	
Max. wire size			Stranded cable		Stranded cable	
	mm <sup>2</sup>		1 x 4 / 2 x 2.5		1 x 2.5 / 2 x 2.5	
	AWG		1 x 12 / 2 x 14		1 x 14 / 2 x 14	
Other data			70.11	70.31/41	70.42/61/62/92	70.51
Power lost to the environment	without output current	W	0.8	0.9	1	2 (230 V AC) / 0.2 (24 V DC)
	with rated output current	W	2	1.2	1.4	2.5 (230 V AC) / 0.5 (24 V DC)

E

## Functions

Output relay On (NO closed) when all OK: positive logic.

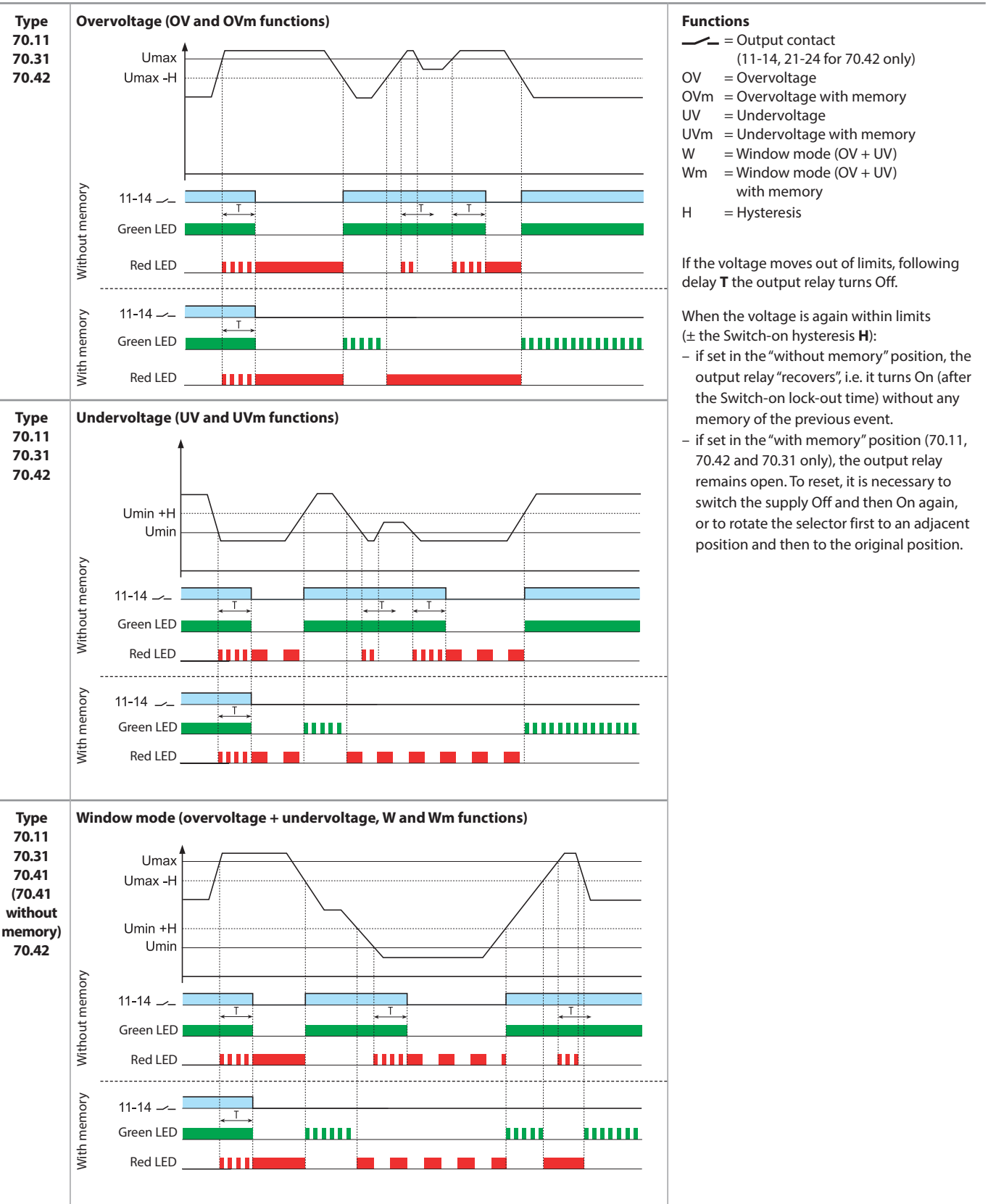



## Functions

Output relay On (NO closed) when all OK: positive logic.

<p><b>Type</b> 70.31 70.41 70.42 70.61 70.62</p>	<p><b>Phase loss and phase rotation</b></p>	<p>If the sequence (L1, L2, L3) is incorrect at power-on, the output relay will not turn-on.</p> <p>If a phase is lost, the output relay turns off immediately. When the phase is again active, the output relay turns on immediately.</p> <p>Phase loss monitoring possible even under regeneration up to 80% of the average of the other 2 phases.</p>
<p><b>Type</b> 70.41 70.42</p>	<p><b>Neutral loss and asymmetry</b></p>	<p>If the neutral is lost (and the Neutral control function is set), the output relay turns off immediately. When the neutral is again present, the output relay turns on immediately.</p> <p>If the asymmetry <math>(U_{max} - U_{min})/U_N</math> is above the % set value, the output relay turns off after the set delay <b>T</b>. When the asymmetry is again below the % set value (with a fixed hysteresis of approximately 2%), the output relay turns on after the Switch-on lock-out time.</p>
<p><b>Type</b> 70.92</p>	<p>* PTC-Break ** PTC-Short circuit *** RESET MEMORY = Operate the RESET key, or interrupt the supply.</p>	<p>The contact open if:</p> <ul style="list-style-type: none"> <li>– thermistor line break</li> <li>– over temperature <math>R_{PTC} &gt; (2.5 \dots 3.6)k\Omega</math></li> <li>– thermistor line short circuit (<math>R_{PTC} &lt; 20 \Omega</math>)</li> <li>– loss of supply</li> </ul> <p>The contact close if:</p> <ul style="list-style-type: none"> <li>– temperature within limits</li> <li>– <math>R_{PTC} &gt; (1.0 \dots 1.5)k\Omega</math> on power-up</li> <li>– <math>(1 \dots 1.5)k\Omega</math> on cooling</li> </ul> <p>In BX mode (BF 0.5s or BL 3s) RESET work on falling front of the signal.</p> <p>In DX mode (DF 0.5s or DL 3s) RESET work on rising front of the signal.</p> <p>RESET signal must be <math>&gt; 1s</math>.</p>

E

Functions

Output relay On (NO closed) when all OK: positive logic.

Type  
70.51

Overcurrent (OC and OCm functions)

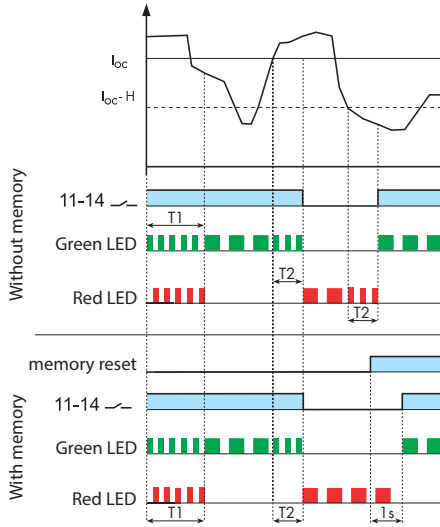

Functions

- = Output contact 11-14
- OC = Overcurrent
- OCm = Overcurrent with memory
- UC = Undercurrent
- UCm = Undercurrent with memory
- W = Window mode (OC + UC)
- Wm = Window mode (OC + UC) with memory
- H = Hysteresis

If the current moves out of limits, following delay **T2** the output relay turns Off.

When the current is again within limits the Switch-on hysteresis **H**:

- if set in the “without memory” position, the output relay “recovers”, i.e. it turns On (after the Switch-on lock-out time) without any memory of the previous event;
- if set in the “with memory” position the output relay remains open.

Undercurrent (UC and UCm functions)

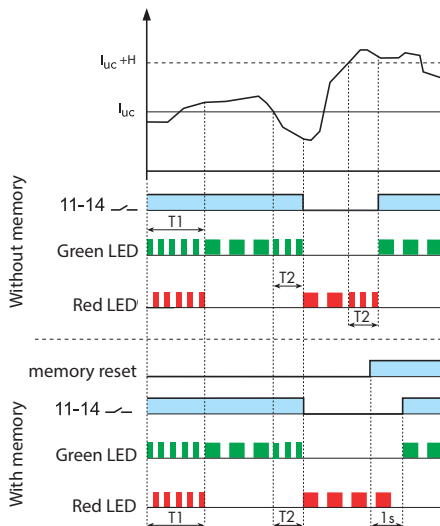

To reset, it is necessary to switch the supply Off and then On again, or to push button connected on RESET terminals.

During **T1** delay the relay don't monitoring.

Window Mode (Overcurrent + Undercurrent, W and Wm functions)

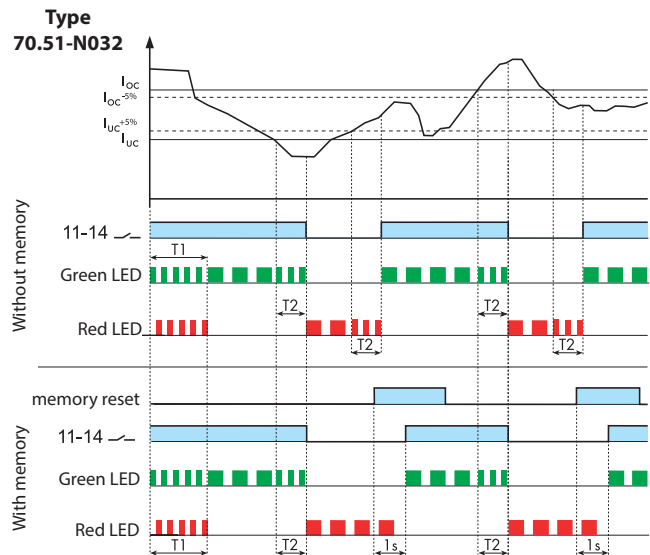
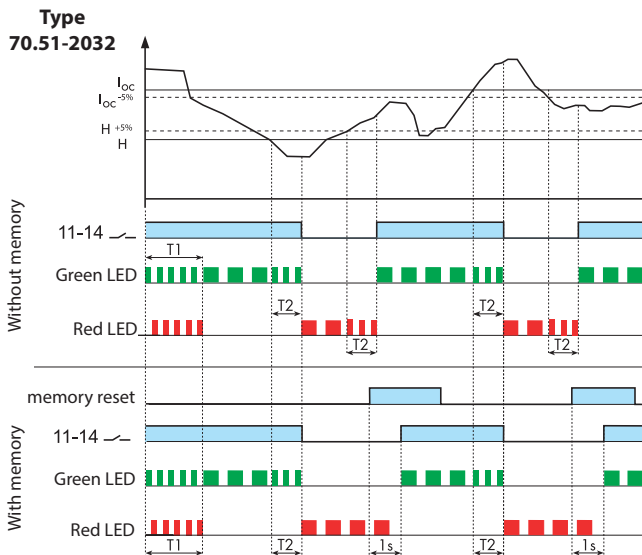

Front view: function selector and regulators

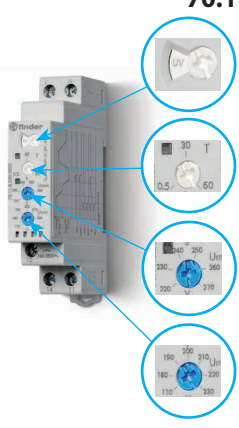
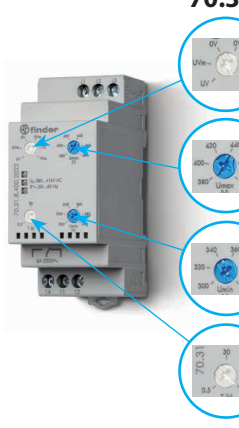
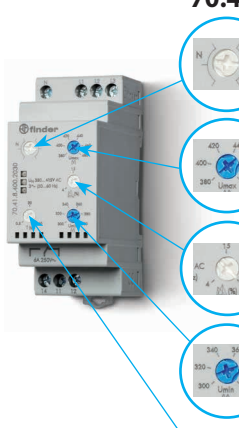
<p><b>70.11</b></p>  <p>Functions: OV, OVm, UV, UVm, W, Wm</p> <p>T<sub>off</sub> delay: (0.5...60)sec</p> <p>U<sub>Max</sub>: (220...270)V</p> <p>U<sub>Min</sub>: (170...230)V</p>	<p><b>70.31</b></p>  <p>Functions: OV, OVm, UV, UVm, W, Wm</p> <p>U<sub>Max</sub>: (380...480)V</p> <p>U<sub>Min</sub>: (300...400)V</p> <p>T<sub>off</sub> delay: (0.5...60) sec</p>	<p><b>70.41</b></p>  <p>N= With N-line monitoring N≠ Without N-line monitoring</p> <p>U<sub>Max</sub>: (380...480)V</p> <p>(4...25)% U<sub>N</sub></p> <p>U<sub>Min</sub>: (300...400)V</p> <p>T<sub>off</sub> delay: (0.5...60)sec</p>
---	--	--

E

<p><b>70.42</b></p>  <p>Functions: OV, OVm, UV, UVm, W, Wm</p> <p>U<sub>Max</sub>: (380...480)V</p> <p>(5...25)% U<sub>N</sub></p> <p>U<sub>Min</sub>: (300...400)V</p> <p>T<sub>off</sub> delay: (0.5...60)sec</p>
---

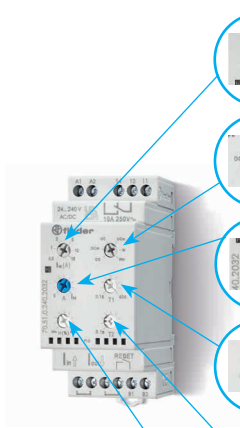
<p><b>70.51</b></p>  <p>Detection levels I<sub>M</sub>: (0.5, 1, 2, 5, 10, 16) A</p> <p>Functions: OC, OCm, UC, UCm, W, Wm</p> <p>Current value (0...I<sub>M</sub>)</p> <p>Switch on lock out time (0.1...40 sec)</p> <p>Switch OFF Delay (0.1...30 sec)</p> <p>Hysteresis 5...50% 1...99% in Window Mode</p>
--

LED indication

Monitoring relays Type	LED	Supply system normal	Supply system abnormal (Voltage out of limits, switch-off delay time T running)	Supply system abnormal (Reason for switch-off, RESET necessary when "with Memory" is selected)
		Contact 11 - 14 closed	Contact 11 - 14 closed	Contact 11-14 open
70.11.8.230.2022	• •		 	Overvoltage OV and OVm Undervoltage UV and UVm With Memory, following a failure a manual "RESET" ** is necessary
70.31.8.400.2022	• • •		 	Overvoltage OV and OVm Undervoltage UV and UVm Phase loss Phase rotation With Memory, following a failure a manual "RESET" ** is necessary
70.41.8.400.2030	• • •		 	Overvoltage OV Undervoltage UV Asymmetry Phase loss Neutral loss Phase rotation
70.42.8.400.2032	• • •		 	Overvoltage OV and OVm Undervoltage UV and UVm Asymmetry Phase loss Neutral loss Phase rotation With Memory, following a failure a manual "RESET" ** is necessary
70.51.0.240.x032	• •		or (during T2 time)  (during T1 time)	or (during T2 time)
70.61.8.400.x000	•			Phase rotation or Phase loss
70.62.8.400.0000	•			Phase loss Phase rotation

\* The function "with Memory" is only available for type 70.11, 70.31, 70.42 and 70.51.

\*\* It is necessary to switch the supply OFF and then On again (U off U on) or to rotate the function selector first to an adjacent position and then to the original position.

Wiring diagrams

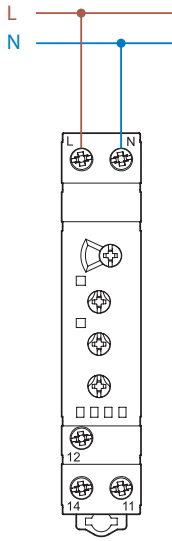

Type 70.11

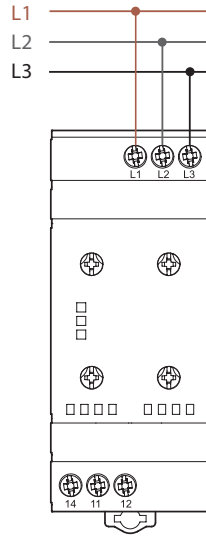

Type 70.31

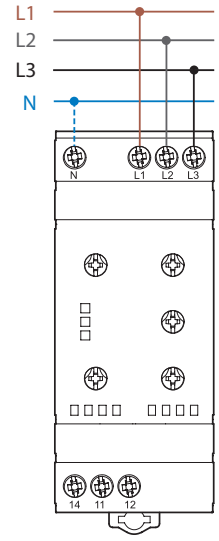

Type 70.41

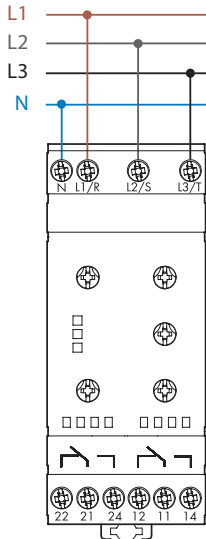

Type 70.42

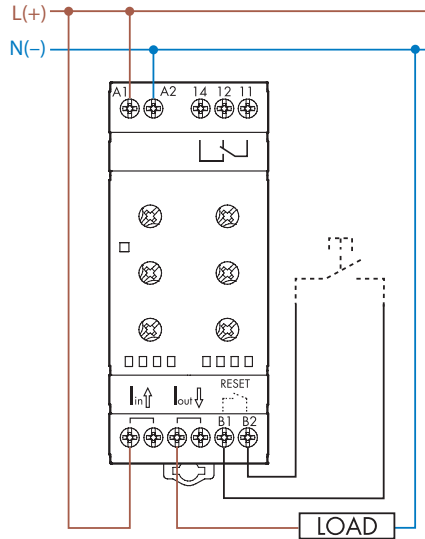

Type 70.51 and 70.51 NFC

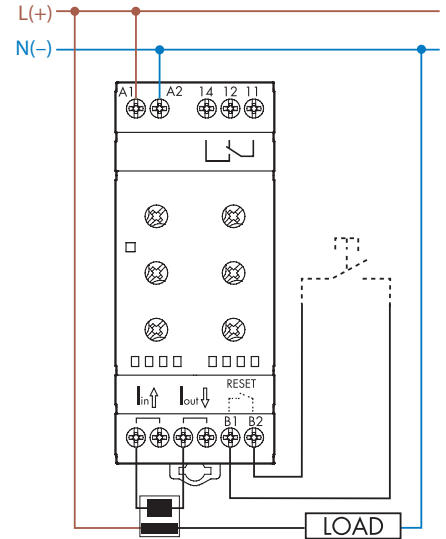

70.51 with TA connection

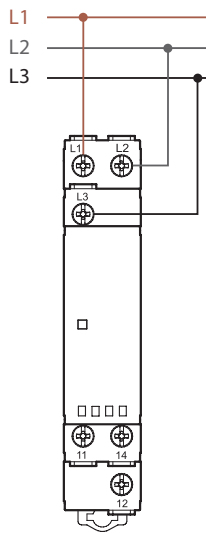

Type 70.61

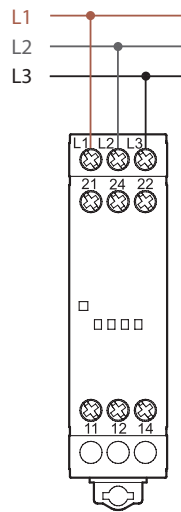

Type 70.62

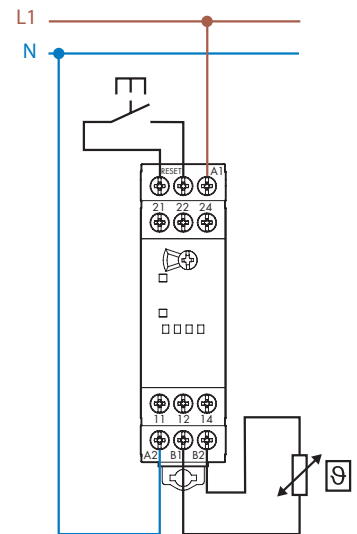

Type 70.92

E

## Wiring diagrams

### Application example

The output contact switches the coil of the line contactor.

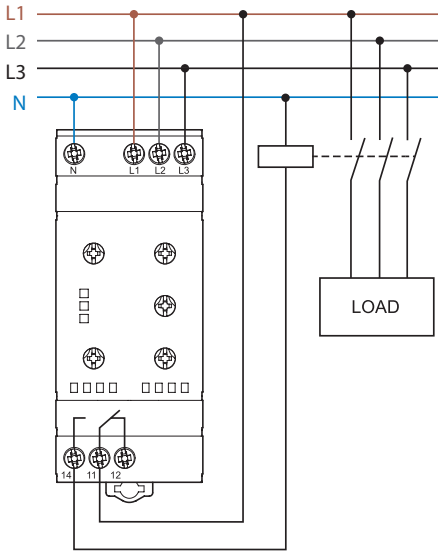

E

## Outline drawings

Type 70.11  
Screw terminal

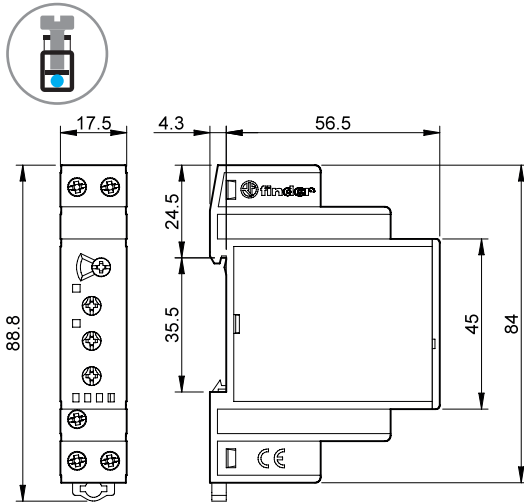

Type 70.31  
Screw terminal

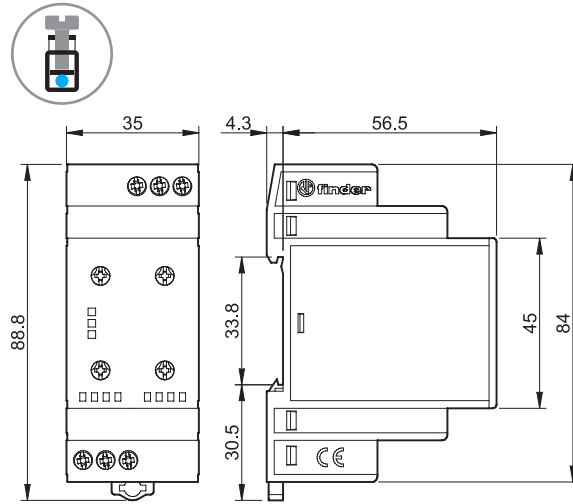

Type 70.41  
Screw terminal

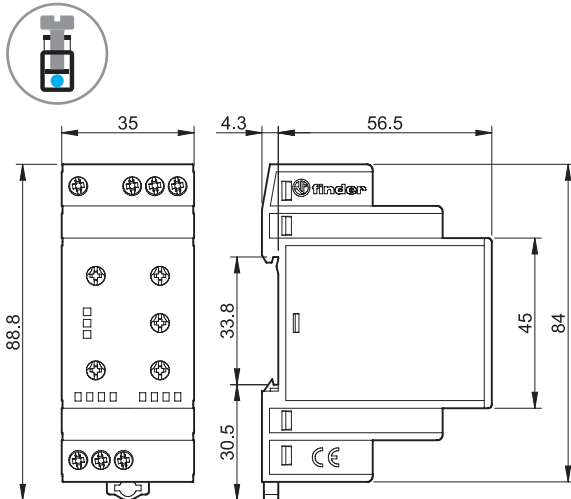

Type 70.42  
Screw terminal

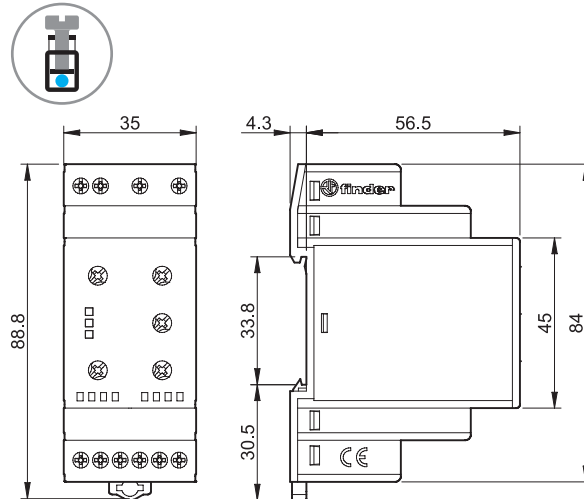

Outline drawings

Type 70.51.0.240.2032  
Screw terminal

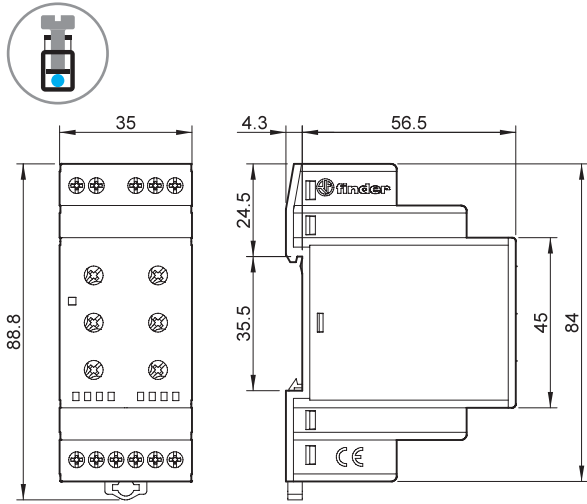

Type 70.51.0.240.N032  
Screw terminal

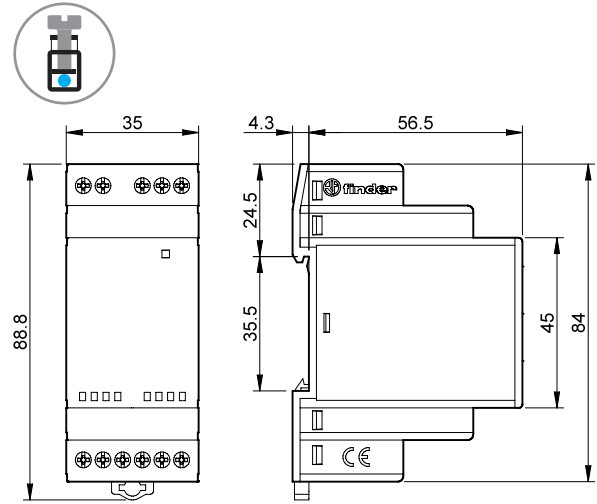

Type 70.61  
Screw terminal

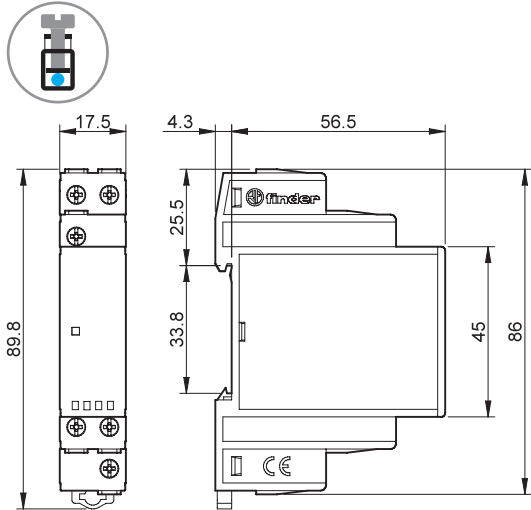

Type 70.61-P000  
Push-in terminal

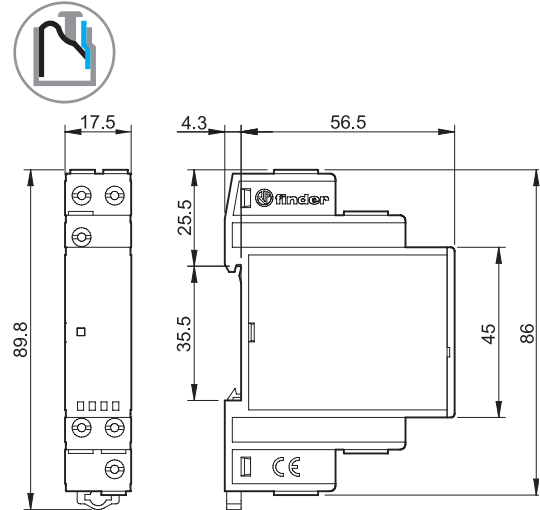

Type 70.62  
Screw terminal

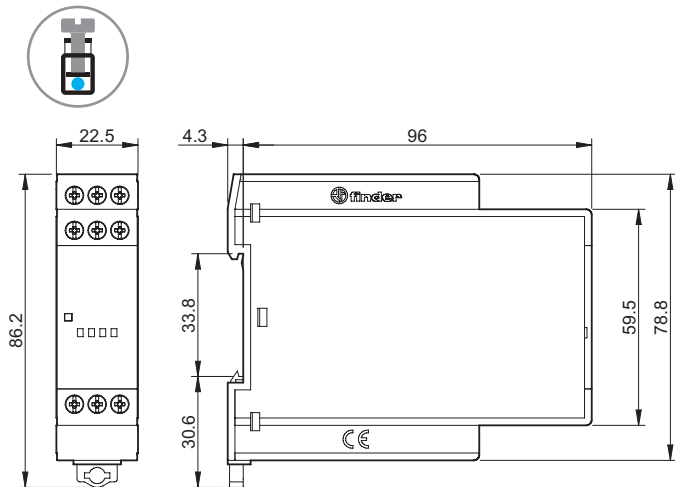

Type 70.92  
Screw terminal

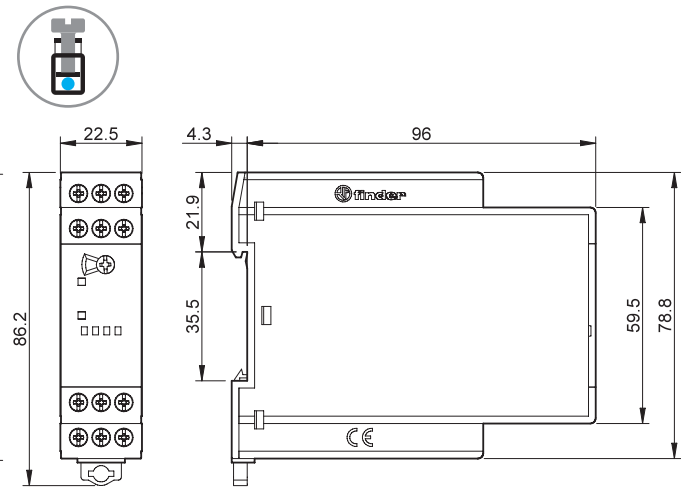

Accessories



020.01

**Adaptor for panel mounting, plastic, 17.5 mm wide for 70.11, 70.61 and 70.92**

020.01

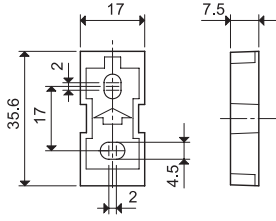

011.01

**Adaptor for panel mounting, plastic, 35 mm wide for 70.31, 70.41, 70.42 and 70.51**

011.01

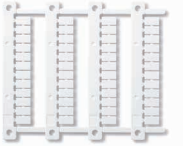
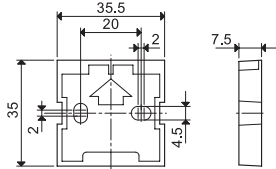

060.48

**Sheet of marker tags (CEMBRE Thermal transfer printers) for relays types 70.11, 70.31, 70.41, 70.42, 70.51, 70.62 and 70.92 (48 tags), 6 x 12 mm**

060.48

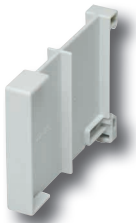

022.09

**Separator for rail mounting, plastic, 9 mm wide**

022.09

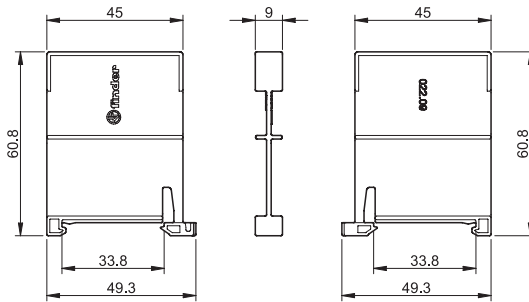



# Monitoring relays and float switch

72  
SERIES



Industrial washing machines



Swimming pools



Control and management of water



Bottling plant



Milk processing plant



Control panels for pumps





**Level control relays for conductive liquids**

**Type 72.01**

- Adjustable sensitivity
- Available also for supply 400 V
- Available also with sensitivity range (5...450)kΩ adjustable
- Available also for contact loads down to 5 V, 1 mA

**Type 72.11**

- Fixed sensitivity
- Emptying or filling functions
- LED indicator
- Reinforced insulation (6 kV - 1.2/50 μs) between:
  - supply and contacts
  - electrodes and supply
  - contacts and electrodes
- 35 mm rail (EN 60715) mount
- Control about a single level or between Min./Max. limits

72.01/11  
Screw terminal



FOR UL RATINGS SEE:  
"General technical information" page V

For outline drawing see page 10

**Contact specification**

Contact configuration		1 CO (SPDT)
Rated current/Maximum peak current	A	16/30
Rated voltage/ Maximum switching voltage	V AC	250/400
Rated load AC1	VA	4000
Rated load AC15 (230 V AC)	VA	750
Single phase motor rating (230 V AC)	kW	0.55
Breaking capacity DC1: 24/110/220 V	A	16/0.3/0.12
Minimum switching load	mW (V/mA)	500 (10/5)
Standard contact material		AgNi

**Supply specification**

Nominal voltage (U <sub>N</sub> )	V AC (50/60 Hz)	24	110...125	230...240	400
	V DC	24	—	—	—
Rated power AC/DC	VA (50 Hz)/W	2.5/1.5			
Operating range	V AC (50/60 Hz)	19.2...26.4	90...130	184...253	360...460
	V DC	20.4...26.4	—	—	—

**Technical data**

Electrical life at rated load AC1	cycles	100 · 10 <sup>3</sup>
Electrode voltage	V AC	4
Electrode current	mA	0.2
Run-on time	s	0.5 - 7 (selectable)
Max sensitivity range	kΩ	5...150 (adjustable)
Insulation between supply/contacts/electrode (1.2/50 μs)	kV	6
Ambient temperature	°C	-20...+60
Protection category		IP 20

**Approvals** (according to type)

**72.01**



- Sensitivity range (5...150)kΩ adjustable
- Delay time (0.5 s or 7 s) switch selectable
- Emptying or filling functions switch selectable

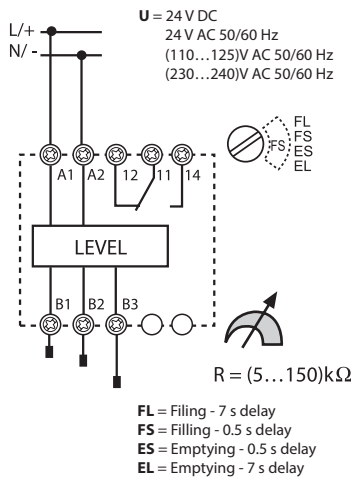

**72.11**



- Sensitivity fixed 150 kΩ
- Delay time fixed: 1 s
- Emptying or filling functions link selectable

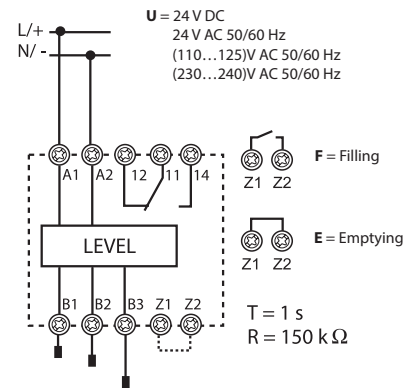

**Special relay for alternating loads, for applications with pumps, compressors, air conditioning or refrigeration units**

**Type 72.42**

- Priority change relay
- 2 independent NO output, 12 A
- 4 functions
- 2 independent control signals, insulated from supply
- 110...240 V and 24 V AC/DC supply versions
- Modular housing, 35 mm wide
- 35 mm rail (EN 60715) mount
- Cd-free contact material

72.42  
Screw terminal



**72.42**



- Multi-function (M1, ME, M2, M1)

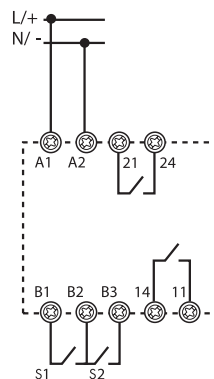

For outline drawing see page 10

**Contact specification**

Contact configuration	2 NO (2 DPST-NO)		
Rated current/Max. peak current	A	12/20	
Rated voltage/ Max. switching voltage	V AC	250/400	
Rated load AC1	VA	3000	
Rated load AC15	VA	1000	
Single phase motor rating (230 V AC)	kW	0.55	
Breaking capacity DC1: 24/110/220 V	A	12/0.3/0.12	
Minimum switching load	mW (V/mA)	300 (5/5)	
Standard contact material	AgNi		

**Supply specification**

Nominal voltage (U <sub>N</sub> )	V AC (50/60 Hz) / DC	24	110...240
Rated power	in stand-by W	0.12	0.18
	with 2 active relays W/VA(50 Hz)	1.1/1.7	1.5/3.9
Operating range	V AC (50/60 Hz)	16.8...28.8	90...264
	V DC	16.8...32	90...264

**Technical data**

Electrical life at rated load AC1	cycles	100 · 10 <sup>3</sup>	
Output delay time (T on function diagrams)	s	0.2...20	
Power-on activation time	s	≤ 0.7	
Minimum impulse duration	ms	50	
Insulation between supply and contacts (1.2/50 μs)	kV	6	
Dielectric strength between open contacts	V AC	1000	
Ambient temperature	°C	-20...+50	
Protection category	IP 20		

**Approvals** (according to type)



## Ordering information

Example: 72 series level control relay, adjustable sensitivity range, (230...240)V AC supply voltage.

7 2 . 0 1 . 8 . 2 4 0 . 0 0 0 0

**Series**

**Type**

- 0 = Level control relay, sensitivity range adjustable (5...150)kΩ
- 1 = Level control relay, sensitivity fixed 150 kΩ
- 4 = Priority change relay

**No. of poles**

- 1 = 1 CO (SPDT)
- 2 = 2 NO (DPST-NO)

**Contact material**

- 0 = AgNi
- 5 = AgNi + Au\*\*

**Supply voltage**

- 024 = 24 V
- 125 = (110...125)V AC
- 230 = (110 ... 240)V
- 240 = (230...240)V AC
- 400 = 400 V AC (72.01 only)

**Supply version**

- 0 = DC/AC (50/60 Hz)
- 8 = AC (50/60 Hz)
- 9 = DC

**All versions**

- 72.01.8.024.0000
- 72.01.8.024.0002\*
- 72.01.8.125.0000
- 72.01.8.240.0000
- 72.01.8.240.0002\*
- 72.01.8.240.5002\*\*
- 72.01.8.400.0000
- 72.01.9.024.0000
- 72.11.8.024.0000
- 72.11.8.125.0000
- 72.11.8.240.0000
- 72.11.9.024.0000
- 72.42.0.230.0000
- 72.42.0.024.0000

**Option**

- 0 = Max. 150 kΩ
- 2 = Sensitivity range adjustable (5...450)kΩ types
- 72.01.8.024.0002\*
- 72.01.8.240.0002\*
- 72.01.8.240.5002\*\*

\* For liquids conductivity up to 2 μ Siemens or a Resistance of 450 kΩ

\*\* For applications with output contact loading down to 5 V, 1 mA



## Technical data

Insulation			72.01/72.11	72.42	
Insulation		Dielectric strength	Impulse (1.2/50 µs)		
		between supply and contacts	4000 V AC	6 kV	6 kV
		between supply and control (for 110...240 V version only)	2500 V AC	—	4 kV
		between electrodes, Z1-Z2 and supply*	4000 V AC	6 kV	—
		between contacts and electrodes	4000 V AC	6 kV	—
	between open contacts	1000 V AC	1.5 kV	1.5 kV	
EMC specifications					
Type of test		Reference standard	72.01/72.11	72.42	
Electrostatic discharge	contact discharge	EN 61000-4-2	4 kV	4 kV	
	air discharge	EN 61000-4-2	8 kV	8 kV	
Radio-frequency electromagnetic field	(80...1000 MHz)	EN 61000-4-3	10 V/m	10 V/m	
	(1...2.8 GHz)	EN 61000-4-3	—	5 V/m	
Fast transients (burst 5/50 ns, 5 and 100 kHz)	on supply terminals	EN 61000-4-4	4 kV	4 kV	
	on control terminals	EN 61000-4-4	—	4 kV	
Voltage pulses on supply terminals (surge 1.2/50 µs)	common mode	EN 61000-4-5	4 kV	4 kV	
	differential mode	EN 61000-4-5	4 kV	4 kV	
Radiofrequency common mode voltage (0.15...280 MHz)	on supply terminals	EN 61000-4-6	10 V	10 V (0.15...230 MHz)	
	on control terminals	EN 61000-4-6	—	10 V	
Voltage dips	70% U <sub>N</sub>	EN 61000-4-11	—	25 cycles	
Short interruptions		EN 61000-4-11	—	1 cycles	
Radiofrequency conducted emissions	(0.15...30 MHz)	CISPR 11	class B	class B	
Radiated emissions	(30...1000 MHz)	CISPR 11	class B	class B	
Terminals					
 Screw torque	Nm	0.8			
Wire strip length	mm	9			
Max. wire size		solid cable	stranded cable		
	mm <sup>2</sup>	1 x 6 / 2 x 4	1 x 4 / 2 x 2.5		
	AWG	1 x 10 / 2 x 12	1 x 12 / 2 x 14		
Other data					
Current absorption on Z1 and Z2 (type 72.11)	mA	< 1			
Current absorption on control signal (B1-B2 and B2-B3) - (type 72.42)		5 mA, 5 V			
Power lost to the environment		<b>72.01/72.11</b>	<b>72.42</b>		
	without contact current	W	1.5	0.9 (1 relay ON)	
	with rated current	W	3.2	3.0 (2 relays ON)	
Max cable length between electrode and relay (types 72.01/72.11)	m	200 (max. capacitance of 100 nF/km)			

\* There is no electrical isolation between electrodes and supply voltage for the 24 V DC types (72.x1.9.024.0000). Therefore, for SELV applications it would be necessary to use a SELV (non-grounded) power supply. In the case of a PELV (grounded) power supply take care to protect the level control relay against harmful circulating currents by ensuring that no electrodes are grounded.

However, there is no such problem for the 24 V AC types (72.x1.8.024.0000) which, by virtue of an internal isolating transformer, assure reinforced isolation between electrodes and supply.

### Functions for 72.01 and 72.11

- U** = Supply voltage
- B1** = Max level electrode
- B2** = Min level electrode
- B3** = Common
- = Contact 11-14
- Z1-Z2** = Link to select emptying (Type 72.11)

LED	Supply voltage	NO output contact	Contacts	
			Open	Closed
	OFF	Open	11 - 14	11 - 12
	ON	Open	11 - 14	11 - 12
	ON	Open (Timing in Progress)	11 - 14	11 - 12
	ON	Closed	11 - 12	11 - 14

### Function and Run-on time

#### Type 72.01

- FL** = Level control by Filling, Long (7 s) run-on delay.
- FS** = Level control by Filling, Short (0.5 s) run-on delay.
- ES** = Level control by Emptying, Short (0.5 s) run-on delay.
- EL** = Level control by Emptying, Long (7 s) run-on delay.

#### Type 72.11

- F** = Level control by Filling, Z1-Z2 open. Run-on time fixed at 1 s.
- E** = Level control by Emptying, Z1-Z2 linked. Run-on time fixed at 1 s.

### Filling functions

#### Wiring diagram

#### Examples with 3 electrodes

##### Type 72.01

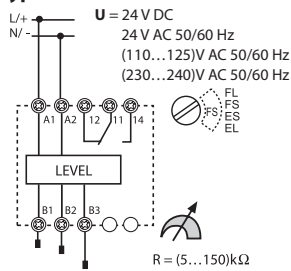

##### Type 72.11

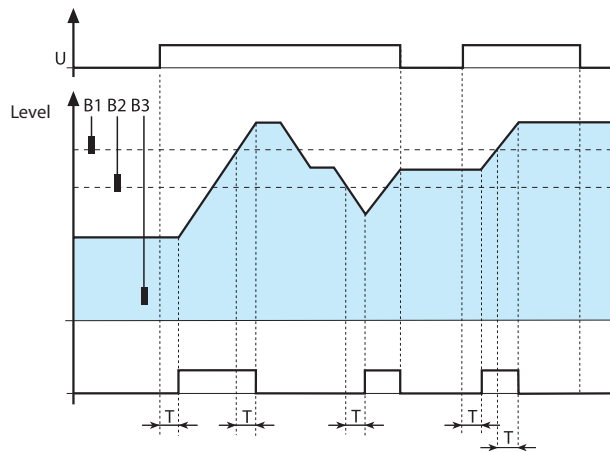
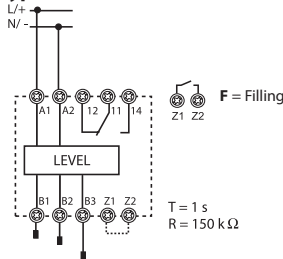

#### Filling Control – between Min. and Max. levels.

Under normal operation the liquid level can be expected to cycle between the Minimum and the Maximum electrodes, B2 and B1 (plus a degree of over and under-shoot).

#### Switch On:

- On “power-up”, if the liquid is below B1 the output relay will operate after time T has expired.
- On the liquid level falling below B2, the output relay will operate after time T has expired.

#### Switch Off:

- On the liquid level reaching electrode B1, the output relay will de-energise after time T has expired.
- On “power-off”, the output relay will immediately de-energise.

#### Wiring diagram

#### Examples with 2 electrodes

##### Type 72.01

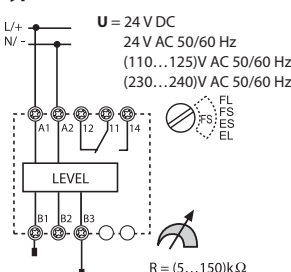

##### Type 72.11

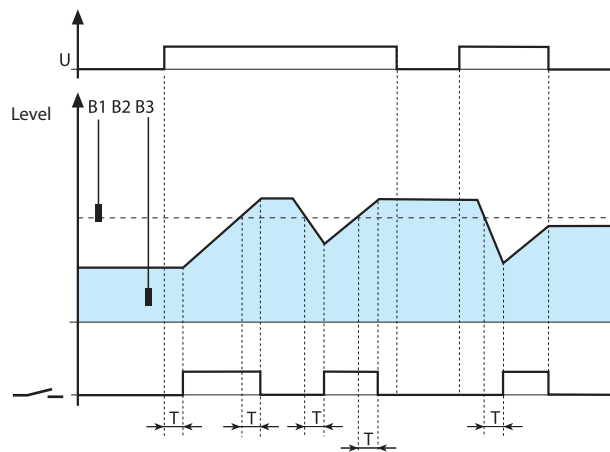
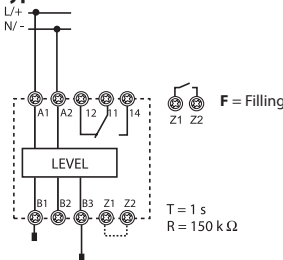

#### Filling Control – about a single level, B1.

Under normal operation the liquid level can be expected to cycle about the level set by electrode B1 with a degree of over and under-shoot.

#### Switch On:

- On “power-up”, if the liquid is below B1 the output relay will operate after time T has expired.
- On the liquid level falling below B1, the output relay will operate after time T has expired.

#### Switch Off:

- On the liquid level reaching electrode B1, the output relay will de-energise after time T has expired.
- On “power-off”, the output relay will immediately de-energise.

Emptying functions

Wiring diagram

Examples with 3 electrodes

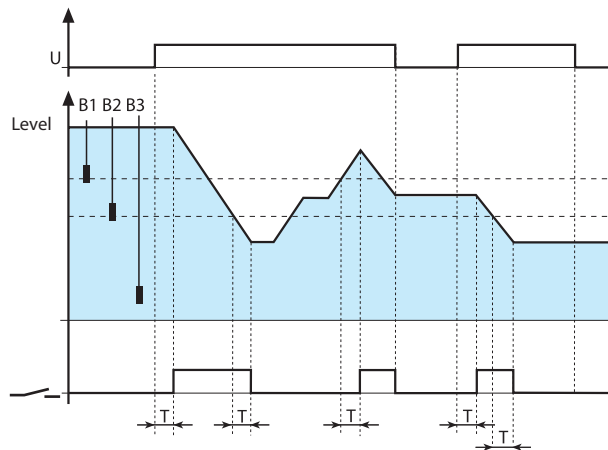
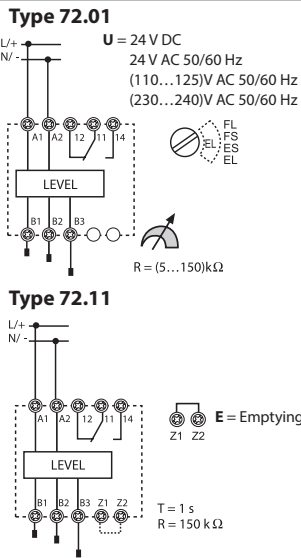

**Emptying Control** - between Max. and Min. levels.  
Under normal operation the liquid level can be expected to cycle between the Maximum and the Minimum electrodes, B1 and B2 (plus a degree of over and under-shoot).

**Switch On:**

- On "power-up", if the liquid level is above B2 the output relay will operate after time T has expired.
- On the liquid level rising to B1, the output relay will operate after time T has expired.

**Switch Off:**

- On the liquid level falling below electrode B2, the output relay will de-energise after time T has expired.
- On "power-off", the output relay will immediately de-energise.

Wiring diagram

Examples with 2 electrodes

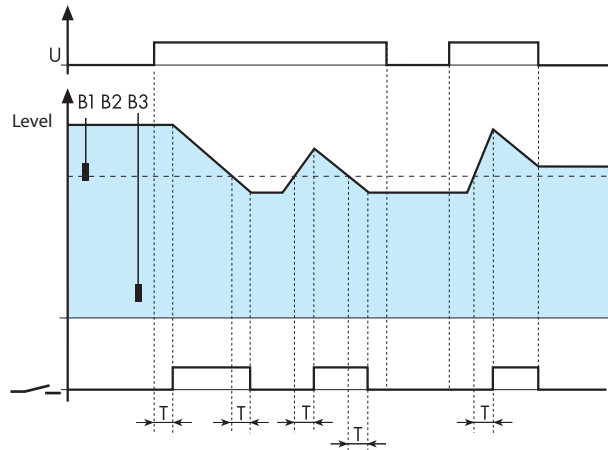
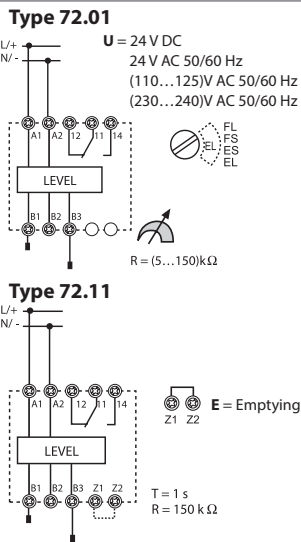

**Emptying Control** about a single level, B1.  
Under normal operation the liquid level can be expected to cycle about the level set by electrode B1 with a degree of over and under-shoot.

**Switch On:**

- On "power-up", if the liquid is above B1 the output relay will operate after time T has expired.
- On the liquid level rising to B1, the output relay will operate after time T has expired.

**Switch Off:**

- On the liquid level falling below electrode B1, the output relay will de-energise after time T has expired.
- On "power-off", the output relay will immediately de-energise.

Applications for 72.01 and 72.11

FILLING function:

Examples with 3 electrodes and with a contactor connected to the contact.

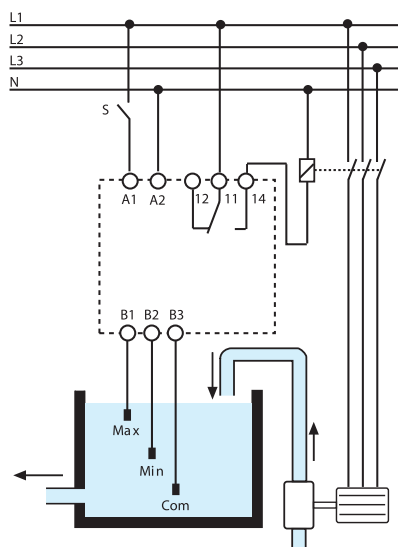

EMPTYING function:

Examples with 3 electrodes and with a motor pump connected directly to the contact.

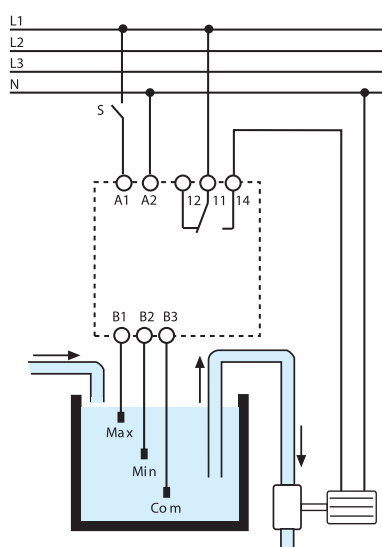

The 72 series level control relays work by measuring the resistance through the liquid, between the common (B3) electrode and Min. and Max. electrodes (B2 and B1). If the tank is metallic, then this can be substituted as the B3 electrode.  
Take care to ensure that the liquid has a suitable resistivity - see below:

**SUITABLE LIQUIDS**

- City water
- Well water
- Rainwater
- Sea water
- Liquids with low-percentage alcohol
- Wine
- Milk, Beer, Coffee
- Sewage
- Liquids fertilizer

**UN-SUITABLE LIQUIDS**

- Demineralised water
- Fuels
- Oil
- Liquids with high-percentage alcohol
- Liquid gas
- Paraffins
- Ethylene glycol
- Paint



Functions for 72.42

A1-A2 = Supply voltage

S1 (B1-B2) = Control signal 1

S2 (B3-B2) = Control signal 2

= Contact 1 (11-14) and  
Contact 2 (21-24)

LED 1 = Output 1

LED 2 = Output 2

LED	
	Device in stand-by, output not activated
	Output not activated, timing in progress
	Output not activated (only functions M1/M2)
	Output activated

Wiring diagram

		<p><b>(MI) Outputs alternate on successive applications of supply voltage</b></p> <ul style="list-style-type: none"> <li>Application of the supply voltage to A1-A2 forces just one output contact to close, but the contact that closes will alternate between 11-14 and 21-24 on each successive application of the supply – ensuring even wear across both motors.</li> <li>The other output contact can be forced closed by the closure of either S1 or S2 - but to limit high current surges the other motor cannot start within T seconds of the first motor.</li> </ul>
		<p><b>(ME) Outputs alternate according to control signal</b></p> <ul style="list-style-type: none"> <li>The supply voltage is permanently applied to A1-A2. When closed, S1 forces just one output contact to close. The contact that closes will alternate between 11-14 and 21-24 on each successive S1 closure - ensuring even wear across both motors.</li> <li>If closed, S2 forces both output contacts to close (irrespective of S1). However, to limit high current surges, both motors cannot start within T seconds of each other.</li> </ul>
		<p><b>(M2) Output 2 (21-24) only</b></p> <ul style="list-style-type: none"> <li>Supply permanently applied to A1-A2.</li> <li>Closure of either S1 or S2 will close output contact 2 (21-24). Use when load 1 (11-14) is out of service.</li> </ul>
		<p><b>(M1) Output 1 (11-14) only</b></p> <ul style="list-style-type: none"> <li>Supply permanently applied to A1-A2.</li> <li>Closure of either S1 or S2 will close output contact 1 (11-14). Use when load 2 (21-24) is out of service.</li> </ul>

E

### MI function example

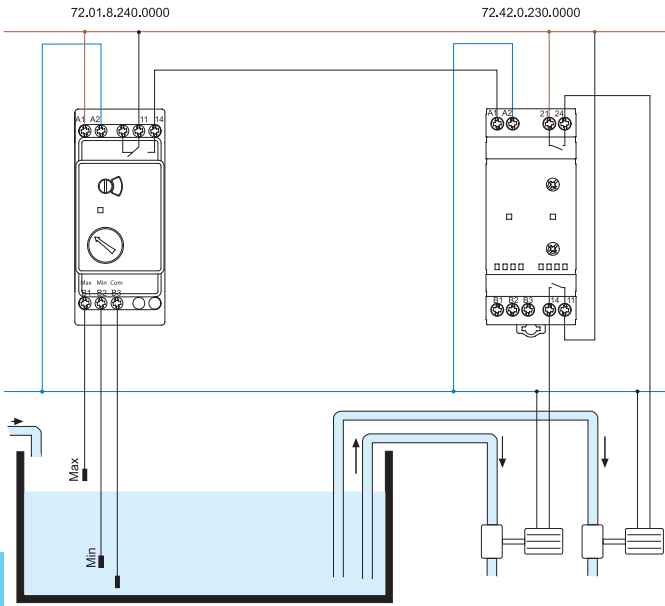

This shows the 72.42 Priority change relay working in conjunction with a single 72.01 level controller. Under normal conditions the liquid level is expected to remain within the range shown as Min to Max. In this case the function of the 72.42 will be to alternate the duty between both pumps, to even wear across both pumps. There is no provision to run both pumps simultaneously.

### ME function example

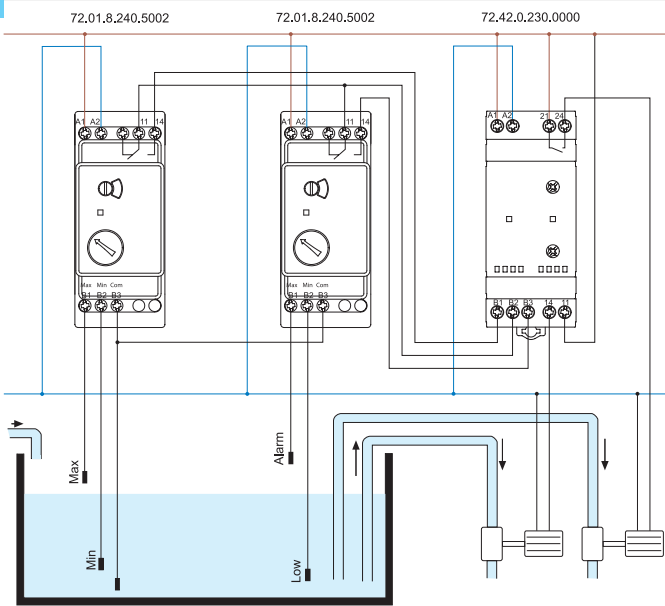

This shows the 72.42 Priority change relay working in conjunction with two 72.01 level controllers. Under normal conditions the liquid level is expected to remain within the range shown as Min to Max. In this case the function of the 72.42 will be to alternate the duty between both pumps, to even wear across both pumps. Should the liquid level rise above the Alarm level then the function of the 72.42 will call for the simultaneous operation of both pumps, by virtue of the signal to terminal B3 from the Alarm/Low level controller.

Note: due to the low level of 72.42 control signals, it is suggested to use level controller 72.01.8.240.5002 because of its superior low load switching capability.

### Outline drawings

Types 72.01/11  
Screw terminal

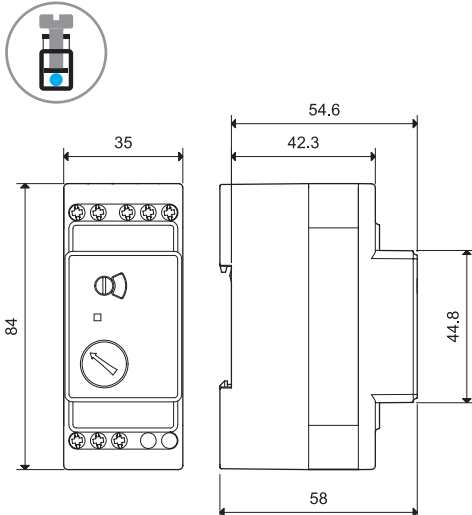

Type 72.42  
Screw terminal

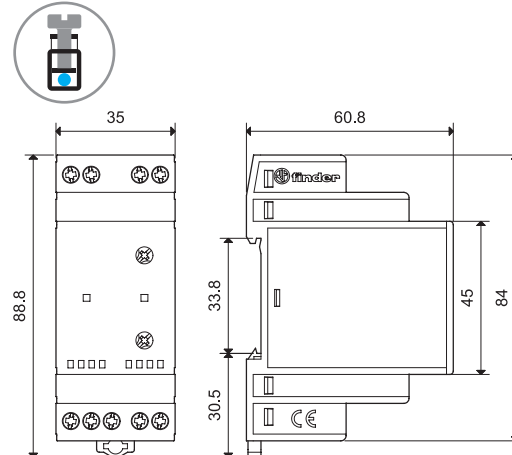

### Accessories for 72.01 and 72.11



072.01.06

**Suspended electrode for conductive liquids**, complete with cable. Suitable for level monitoring in wells and reservoirs not under pressure.

- Electrode compatible with food processing applications (according to European Directive 2002/72 and cod. FDA title 21 part 177):

Cable length: 6 m (1.5 mm <sup>2</sup> )	072.01.06
Cable length: 15 m (1.5 mm <sup>2</sup> )	072.01.15



072.02.06

- Electrode for swimming pools with high levels of chlorine, or in salt-water pools with high levels of salinity:

Cable length: 6 m (1.5 mm <sup>2</sup> )	072.02.06
--	-----------

Technical data	
Max. liquid temperature	°C +100
Electrode material	stainless steel (AISI 316L)

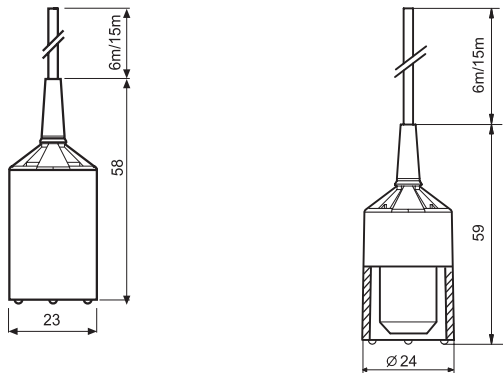

072.41

<b>Suspended electrode</b>	072.41
Technical data	
Max liquid temperature	°C +80
Cable grip	mm $\varnothing \leq 2.5 \dots 3.5$
Electrode material	stainless steel (AISI 316L)
Casing material	polypropylene
Max screw torque	Nm 0.7
Max. wire size	mm <sup>2</sup> 1 x 2.5
	AWG 1 x 14
Wire strip length	mm 5...9

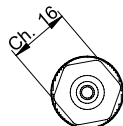
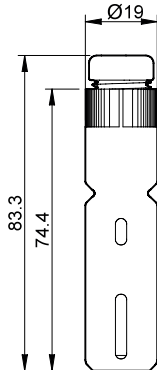

## Accessories for 72.01 and 72.11



072.11

<b>Floor water sensor</b> , designed for the detection and reporting of the presence of floor surface water.		072.11
<b>Technical data</b>		
Electrode material	stainless steel (AISI 301)	
<b>Wire capability of terminals</b>		
Max screw torque	Nm	0.8
Max. wire size	solid cable	
	mm <sup>2</sup>	1 x 6 / 2 x 6
	AWG	1 x 10 / 2 x 10
stranded cable		1 x 6 / 2 x 4
Wire strip length		mm 9
<b>Other data</b>		
Distance between electrodes and floor	mm	1
Floor fixing screw diameter	Maximum M5	
Maximum cable diameter	mm	10
Maximum length of cable connecting sensor to relay	m	200 (with capacitance of 100 nF/km)
Max. liquid temperature	°C	+100

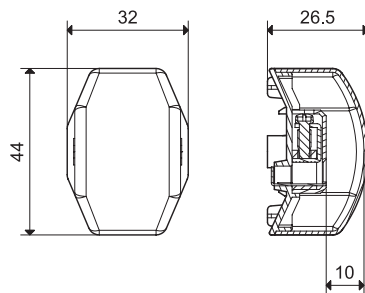

Floor surface water sensor for connection to electrode terminals (B1 and B3) of 72.01 or 72.11 level control relay, set in Emptying function (ES or E respectively).

For ice bank control in refrigeration systems it is suggested to use the high sensitivity (5...450)kΩ types - 72.01.8.024.0002 or 72.01.8.230.0002.

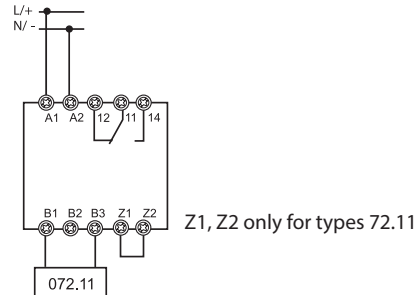
**Function**

072.51

<b>Electrode holder with two pole connector</b> , one connected directly to the electrode and the second connected to the grounded installation thread. Suitable for metal tank with G3/8" linkage. Electrode not included. Order appropriate number of electrodes holders - additional to the relay.		072.51
<b>Technical data</b>		
Max liquid temperature	°C	+100
Max tank pressure	bar	12
Cable grip	mm	∅ ≤ 6
Electrode material	stainless steel (AISI 316L)	

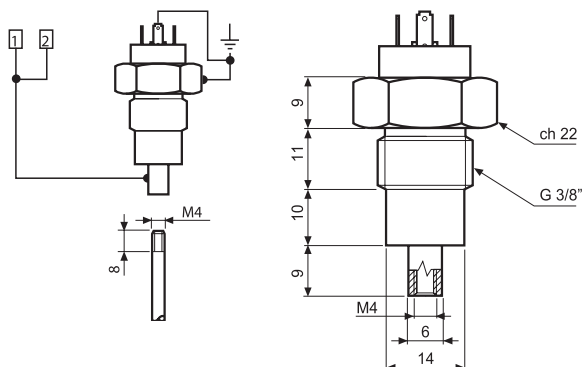

Accessories for 72.01 and 72.11



072.53

<b>Electrode holder with three poles.</b> Electrode not included.		
Order appropriate number of electrodes holders - additional to the relay.		072.53
<b>Technical data</b>		
Max liquid temperature	°C	+70
Electrode material		stainless steel (AISI 303)

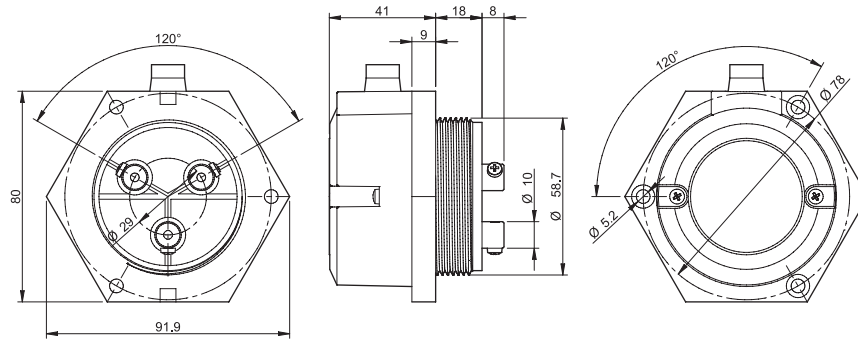

**Electrode and electrode connector**, multiple electrodes may be interconnected to provide required length

<b>Technical data</b>		
Electrode - 475 mm long, M4 thread, stainless steel (AISI 316L)		072.500
Inter-electrode connector - M4 thread, stainless steel (AISI 316L)		072.501

072.500

072.501

Illustration of interconnection of electrodes.



<b>Electrode separator</b>	072.503
----------------------------	---------



072.503

<b>Adaptor for panel mounting</b> , plastic, 35 mm wide	011.01
---	--------

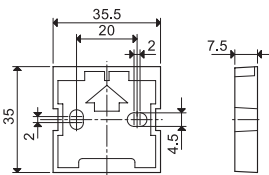

011.01

<b>Sheet of marker tags (CEMBRE Thermal transfer printers)</b> for relays types 72.42 (48 tags), 6 x 12 mm	060.48
--	--------

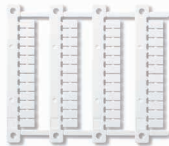

060.48

<b>Identification tag</b> , plastic, 1 tag, 17 x 25.5 mm (for 72.42 only)	019.01
---	--------



019.01

## Application notes for 72.01 and 72.11

### Applications

The main application for these relays is for the sensing and control of the level of conductive liquids.

Selectable options allow for this control to be achieved either through a filling operation or through an emptying operation, and in either case "positive logic" is used.

Level control can be achieved around a single level - using 2 electrodes, or between Minimum and Maximum levels - using 3 electrodes.

Additionally, the 72.01, with its adjustable sensitivity setting, can be ideal for monitoring the conductivity of liquids.

### Positive safety logic

These relays work according to the principle that it is the closure of a normally open output contact that will be used to control the pump, both in filling and emptying applications. Consequently, in the event of a failure of the supply local to the relay, the filling or emptying will cease. This is generally considered to be the safest option.

### Overrunning of tank on filling

Care must be exercised to ensure that the tank cannot overrun. Factors that have to be considered are the pump performance, the rate of discharge from the tank, the position of the single level electrode (or maximum electrode), and the run-on time delay. Keeping the time delay to a minimum will minimise the possibility of tank overrun, but will increase the installed switching rate.

### Prevent dry running of pump on emptying

Care must be exercised to ensure that the pump cannot run dry. Similar considerations must be given as outlined above. In particular, keeping the run-on time delay to a minimum will minimise the risk, but again, it will increase the installed switching rate.

### Run-on time

In commercial and light industrial applications the use of a short Run-on time delay is more appropriate, due to the relatively small size of tanks and the consequential need to react quickly to the change in level. Larger scale industrial applications involving larger tanks and powerful pumps must avoid a frequent switching cycle, and the use of the 72.01 set for the longer Run-on time of 7 seconds is suggested.

Note that the short run-on time will always achieve closer control to the desired level(s), but at the cost of more frequent switching.

### Electrical life of the output contact

The electrical life of the output contact will be enhanced where a larger distance between the Max. and Min. electrodes (3-electrode control) can be realised. A smaller distance, or level control to a single level (2-electrode control), will result in more frequent switching and therefore a shorter electrical life for the contacts. Similarly, the long run-on time will enhance, and the short time will reduce, electrical life.

### Pump control

Small single-phase pumps within the kW (0.55 kW - 230 V AC) rating stated may be driven directly by the level relay output contact. However, where very frequent switching is envisaged, it is better to "slave" a higher power relay or contactor to drive the pump motor. Large pumps (singlephase and three-phase) will of course require an interposing contactor.

### Water leakage and condensation in oil lubrication systems

To detect condensed water vapour or water leakage within lubricating systems, monitor by sensors connected to B1 - B3 (Function E or ES, Z1 - Z2 linked). Condensed water vapour has low conductivity, therefore choose monitoring relay type 72.01.8.240.0002 with sensitivity range of (5...450) k $\Omega$  and sensor type 072.11.

### Floor flooding control

To detect floor water due to spills or flooding, monitor using sensors connected to B1 - B3 (Function E or ES, Z1 - Z2 linked).

Choose monitoring relay type 72.01.8.240.0000 or 72.11.8.240.0000, together with floor water sensor type 072.11.

### Electrodes and cable lengths

Normally 2 electrodes or 3 electrodes will be required for control about a single level, or control between Min. and Max. levels, respectively. However, if the tank is made of conductive material it is possible to use this as the common electrode, B3, if electrical connection can be made to it.

The maximum permitted length of cable between the electrode and the relays is 200m, for a cable not exceeding 100 nF/km.

A maximum of 2 relays and associated electrodes can be employed in the same tank - if two different levels need monitoring.

Note: It is permitted to make direct electrical connection between terminals B1-B3, and B2-B3, (without using electrodes/liquid), but in this case it is not possible to set up the sensitivity.

### Electrode choice

The choice of electrodes may depend on the liquid being monitored. Standard electrodes 072.01.06 and 072.51 are suitable for many applications but some liquids may be corrosive for example, and may therefore require custom made electrodes - but these can usually be used with the 72.01 and 72.11 relays.

### On site commissioning

To confirm the suitability of the relay sensitivity to the resistance between electrodes it is suggested that the following checks are made. For convenience it is suggested that the fill function and the shortest run-on time are selected.

### Commissioning

Follow these setting-up instructions to achieve correct operation:

#### 72.01

Select the function "FS" (Filling and Short delay of 0.5 s), and set the sensitivity control to 5 k $\Omega$ . Ensure that all electrodes are immersed in the liquid - expect the output relay to be ON. Then, slowly rotate the sensitivity control in the 150 k $\Omega$  direction until the level relay switches OFF (internal output relay will switch OFF and red LED will switch slowly flash).

(If the level relay does not switch OFF then, either the electrodes are not immersed, or the liquid has too high impedance or the distance between electrodes is too long.)

Finally, select the filling or emptying function as required, run in real time and confirm that the level relay works as required.

#### 72.11

Select the Filling function "F", (Z1 - Z2 open). Ensure that all electrodes are immersed in the liquid, but leave electrode B3 disconnected - output relay should be ON. Connect electrode B3, and the level relay should switch OFF (internal output relay will switch OFF and red LED will switch slowly flash).

(If the level relay does not switch OFF then, either the electrodes are not immersed, or the liquid has too high impedance or the distance between electrodes is too long.)

Finally, select the filling or emptying function as required, run in real time and confirm that the level relay works as required.

**Float switch suitable for fluid level regulation**

- 1 CO (SPDT)
- 10 A (resistive load)
- 8 A (inductive load)
- Cable length 5 m, 10 m, 15 m or 20 m
- Suitable for emptying and filling
- Contact material AgNi

**72.A1.1000.xxxx**



- Float switch for grey water pumping and drainage
- Counterweight (110 g) with cable grip, included

**72.A1.0000.xx02**



- Float switch for fluid foodstuff and potable water
- Suitable for swimming pools with high levels of chlorine, or in salt-water pools with high levels of salinity
- Counterweight (110 g) with cable grip, included
- Cable and plastics ACS certified for alimentary uses

**72.B1.1000.xxxx**



- Float switch for black water systems, drainage plants and pumping stations

\* H05 RN F cable approved TÜV

For outline drawing see page 19

**Technical data**

Contact configuration		1 CO (SPDT)	1 CO (SPDT)	1 CO (SPDT)
Rated current	A	10 A (8 A)	10 A (8 A)	10 A (8 A)
Rated voltage	V AC	250	250	250
Protection degree		IP 68	IP 68	IP 68
Max liquid temperature	°C	+45	+45	+45
Max pressure	BAR	10	10	10
Cable material		H05 RN F*	ACS	H05 RN F*
Body material		Polypropylene	Polypropylene	Polypropylene
<b>Approvals</b> (according to type)		<b>CE UK EAC</b>	<b>CE UK ACS</b>	<b>CE UK EAC</b>

E

**Float switch suitable for fluid level regulation**

- 1 CO (SPDT)
- 10 A (resistive load)
- 8 A (inductive load)
- Space saving version, for narrow spaces
- Manual switch for automatic (ON/OFF) or manual (always ON) operation
- Cable length 2 m
- Suitable for emptying and filling

**NEW 72.C1.0000.0201**



- Space saving version, for narrow spaces .
- Magnetic contact
- Cable length 2 m



Manual switch

\* H07 RN F cable approved TÜV

For outline drawing see page 20

**Technical data**

Contact configuration		1 CO (SPDT)
Rated current	A	10 A (8 A)
Rated voltage	V AC	250
Minimum switching load	mW (V/mA)	1200 (12/100)
Breaking capacity DC1		6 A - 30 V DC
Protection degree		IP 68
Max liquid temperature	°C	+50
Max depth	m	10
Cable material		H07 RN F*
Body material		Polypropylene
<b>Approvals</b> (according to type)		<b>CE UK EAC</b>

E



### Ordering information

Example: 72 Series, float switch, 1 CO (SPDT).

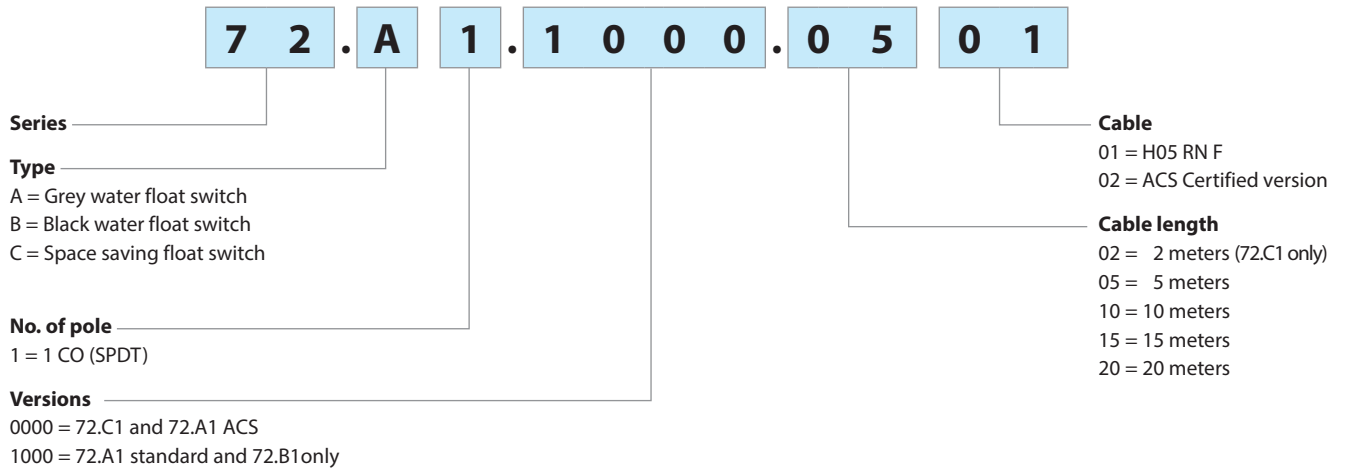

### Accessories - Included in the package

Counterweight for type 72.A1



Counterweight (110 g) for Type 72.A1. Fixes to the cable to allow adjustment of the overall level and the switching hysteresis.



Mounting bracket and clamps to simplify wall or pipe installation.

E

## Applications

### Type 72.A1

Emptying function

Filling function

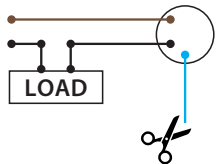
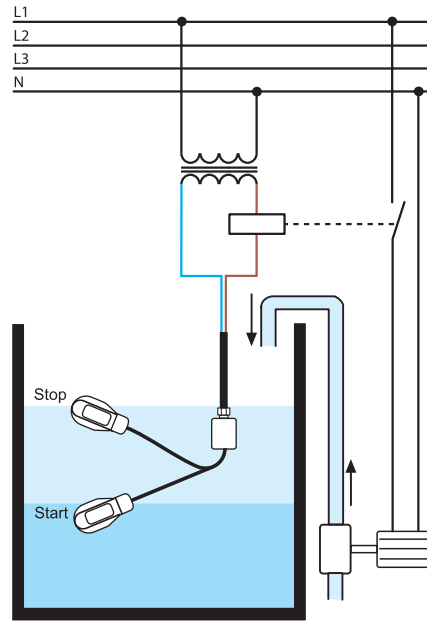
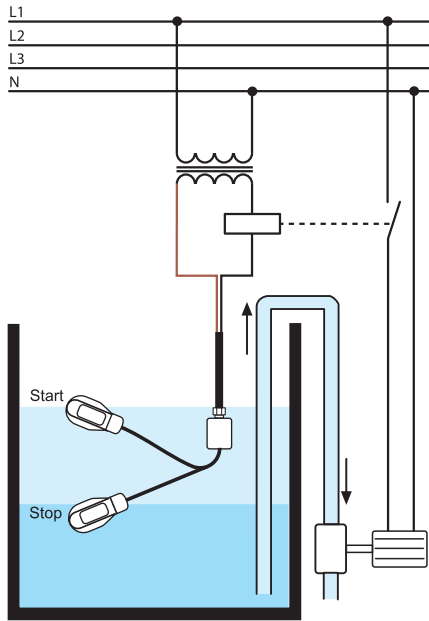

When black and brown wires are used, the circuit opens when the float is down and closes when the float is up. In this case the blue wire must be insulated.

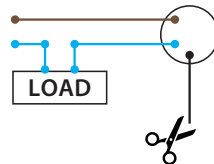

When brown and blue wires are used, the circuit opens when the float is up and closes when the float is down. In this case the black wire must be insulated.

### Type 72.B1

Emptying function

Filling function

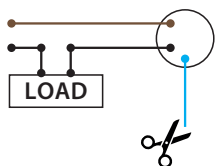
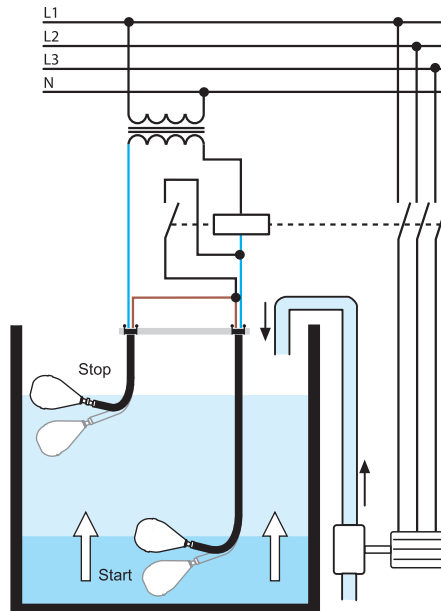
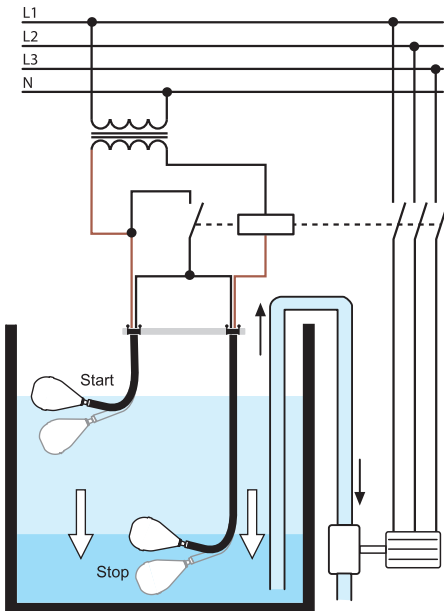

When black and brown wires are used, the circuit opens when the float is down and closes when the float is up. In this case the blue wire must be insulated.

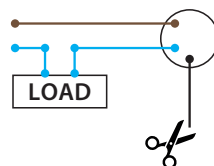

When brown and blue wires are used, the circuit opens when the float is up and closes when the float is down. In this case the black wire must be insulated.

### Example

Type 72.C1

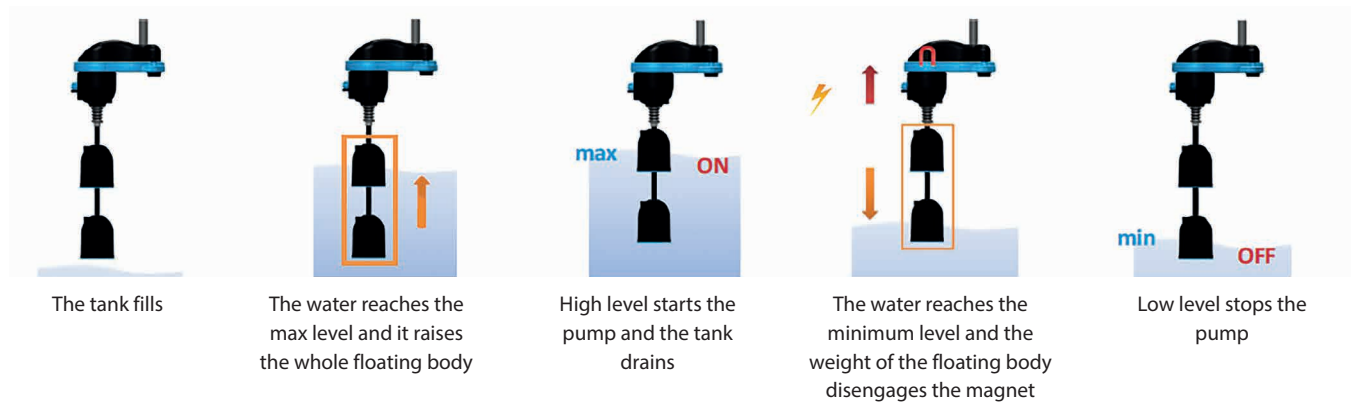

### Functions

**Emptying:** when black and brown wires are used, the circuit opens when float is down and closes when the float is up.  
Note: the blue/grey wire must be insulated.

**Filling:** when black and blue/grey wires are used, the circuit closes when float is down and opens when the float is up.  
Note: the brown wire must be insulated.

N.B: The grounding wire is always yellow and green.

### Outline drawings

Type 72.A1- xx02

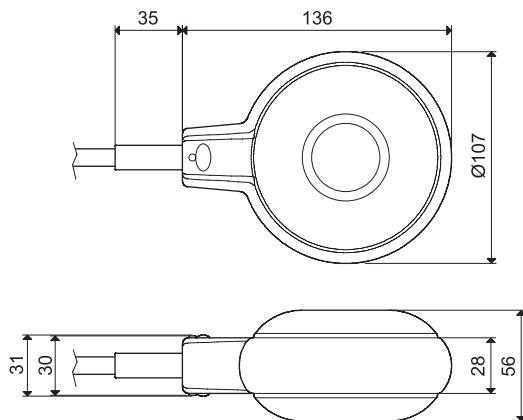

Type 72.A1

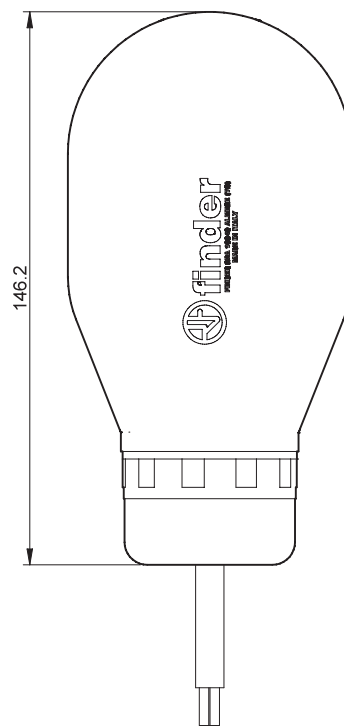

Type 72.B1

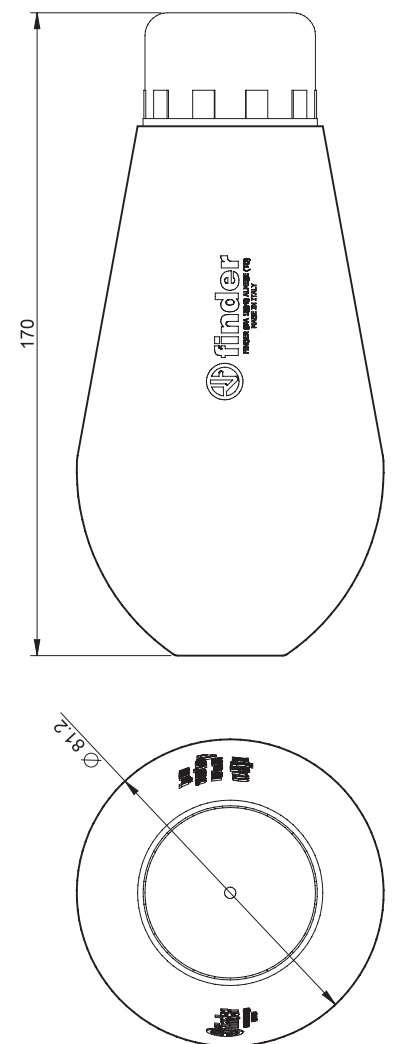

Outline drawings

Type 72.C1

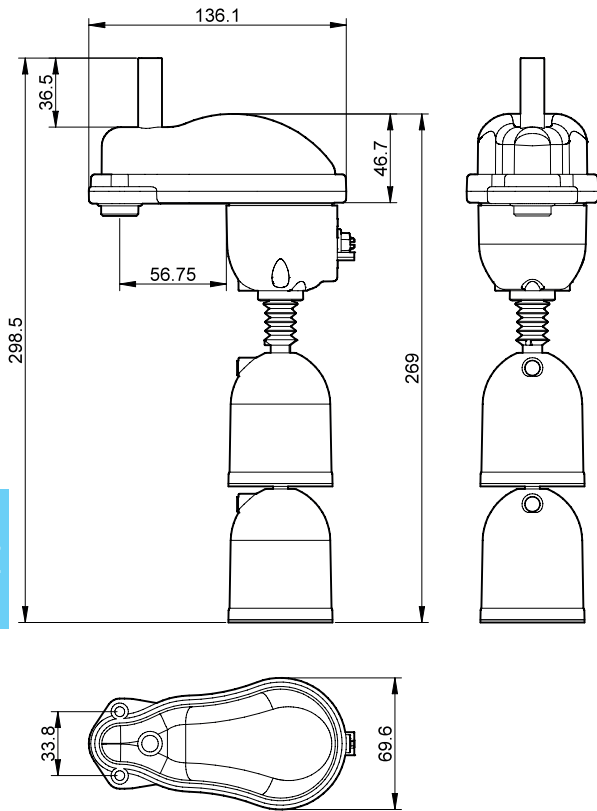

E

# Power analyzer products

6M  
SERIES



Panels for electrical distribution



Control panels



Electrical energy control



Industrial robots



Inverters



Charging Stations



PV applications

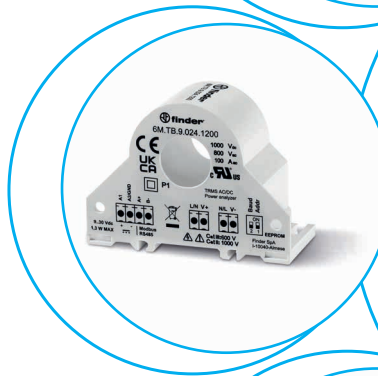



**Single phase power monitor with TRMS AC and DC measurement capability**

**Type 6M.TA.9.024.1200**

- 50A - 800 V AC / 1000 V DC

**Type 6M.TB.9.024.1200**

- 100A - 800 V AC / 1000 V DC

**Type 6M.TF.9.024.1200**

- 300A - 800 V AC / 400A - 1000 V DC

- Modbus RS485 communication port
- Instantaneous values measured: V (RMS), A (RMS), PF, kW, kVA, kvar, Hz, THD (I), Vpk, Ipk, Cosφ
- Bi-directional energy measurement: kWh
- Accuracy Class: 0.5% F.S.
- Available measure register: MSW first, LSW first or hundredths
- Fully configurable by Modbus RS485 interface
- Conform to EN 61010-1/2010
- 35 mm Rail mounting (rail adaptor included)

**NEW 6M.TA.9.024.1200**



- 50A - 800 V AC / 1000 V DC
- Modbus RS485 interface

**NEW 6M.TB.9.024.1200**

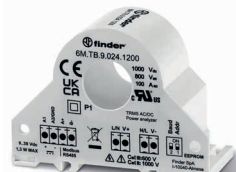

- 100A - 800 V AC / 1000 V DC
- Modbus RS485 interface

**NEW 6M.TF.9.024.1200**



- 300A - 800 V AC / 400A - 1000 V DC
- Modbus RS485 interface

For outline drawing see page 6

**Specification**

Measurement method		TRMS (AC)/DC	TRMS (AC)/DC	TRMS (AC)/DC
Nominal current AC/DC	A	50/50	100/100	300/400
Minimum measured current I <sub>min</sub> AC/DC	A	0.5	0.5	0.5
Maximum measured current I <sub>pk</sub> AC/DC	A	90	180	450
Current Accuracy class		0.5% F.S.	0.5% F.S.	0.5% F.S.
Voltage Accuracy class		0.5% F.S.	0.5% F.S.	0.5% F.S.
Voltage measurement range for AC system V AC		90...800	90...800	90...800
Voltage measurement range for DC system V DC		90...1000	90...1000	90...1000
Working frequency	Hz	DC or 1...400	DC or 1...400	DC or 1...400
Sampling rate	Hz	11 000	11 000	11 000
Nominal supply voltage	V DC	24	24	24
Operating range	V DC	9...30	9...30	9...30
Max power consumption	W	<1.3	<1.3	<1.3

**Technical data Modbus protocol**

Bus System		Modbus RS485 RTU	Modbus RS485 RTU	Modbus RS485 RTU
Frame		8, N, 1	8, N, 1	8, N, 1
Max bus length	m	1000	1000	1000
Baud rate	Baud	1200...115 200	1200...115 200	1200...115 200

**Technical data**

Accuracy Class for V, I, W	%	0.5	0.5	0.5
Accuracy Class for kWh	%	1	1	1
Ambient temperature range	°C	-15...+65	-15...+65	-15...+65
Overvoltage category up to 600 V		III	III	III
Overvoltage category up to 1000 V DC		II	II	II
Protection category		IP 20	IP 20	IP 20
Dimensions with mounted connectors (LxHxD)		63 x 46.2 x 41.94		99.25 x 89.1 x 43-41

**Approvals (according to type)**



**Modbus TCP/IP to Modbus RS485 gateway with on board web server interface, up to 10 clients**

- Ethernet com port: 10/100 Mb/s
- Modbus RTU com port: RS485 up to 115 200 bit/s
- Insulation between power supply, RS485, Ethernet: 1500 V
- User interface: 6 LED status indication
- Up to 10 Ethernet clients
- Conform to: EN 61000-6-4/2006 + A1 2011; EN 64000-6-2/2005; EN 61010-1/2010

**NEW** 6M.BU.0.024.2200

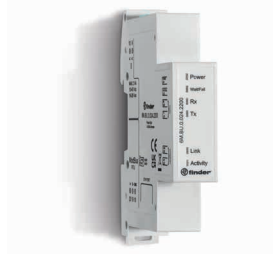

- Modbus TCP/IP to Modbus RS485 gateway
- Up to 200 modbus devices
- Up to 10 clients

E

For outline drawing see page 6

Protocol type		
Modbus TCP/IP to Modbus RS485 gateway		
Nominal supply voltage	V AC/DC	24/24
Operating range	V AC/DC	19...28/10...40
Max power consumption	W	<1.5
Communication port specification		
Ethernet com port	Mb/s	10-100 Mb/s (Max 10 Client)
RS485 RTU com port	Baud	1200 - 115 200 (Max 200 slave)
Ambient temperature range	°C	-20...+60
Approvals (according to type)		CE UK CA



### Ordering information

Example: 6M series, 1ph power monitor up to 100 A, ModbusRS485 com port, 0.5% accuracy with 35 mm rail adaptor for mounting.



**Series**

**Type**

TA = 50A - 800 V AC / 1000 V DC  
TB = 100A - 800 V AC / 1000 V DC  
TF = 300A - 800 V AC / 400A - 1000 V DC  
BU = Modbus TCP/IP to Modbus RS485 gateway

**Supply version**

0 = AC/DC  
9 = DC

**Supply voltage**

024 = 24 V

**Option**

2 = Modbus RS485 RTU

**Version**

1 = CT shape  
2 = Wired with RJ45 (only for 6M.BU)

### Wiring diagrams

Type 6M.TA, 6M.TB and 6M.TF

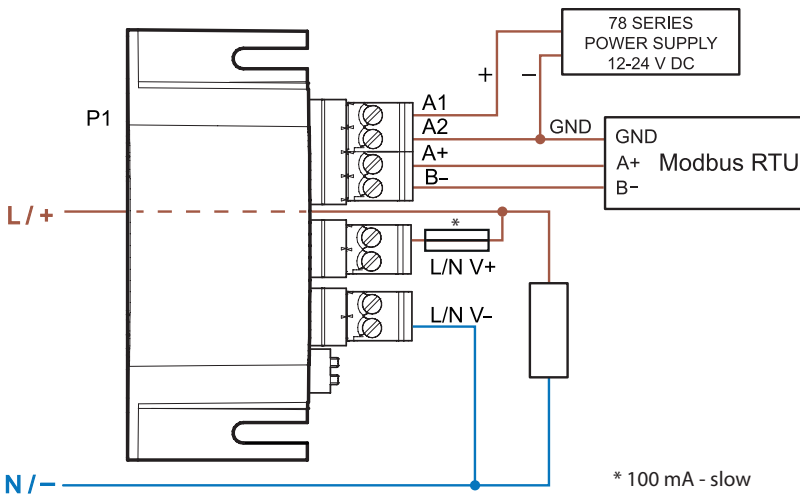

Type 6M.BU with 78.12

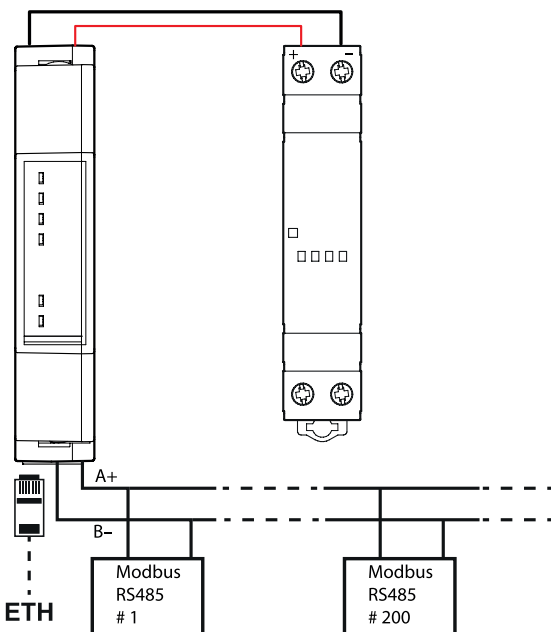

Type 6M.TX with 78.12

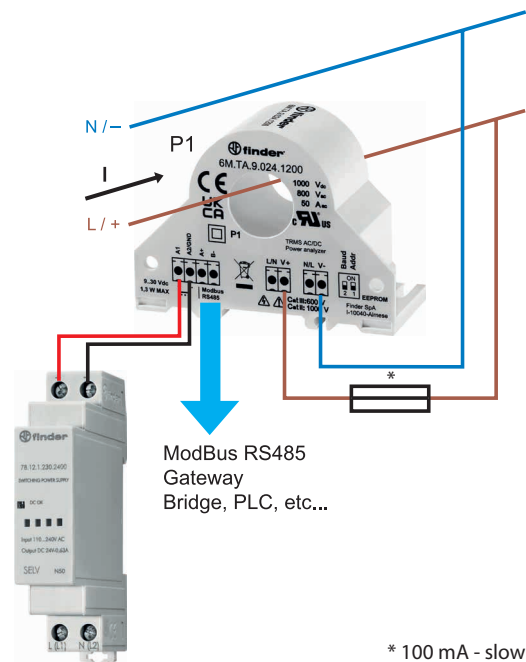

## Outline drawings

Type 6M.TA

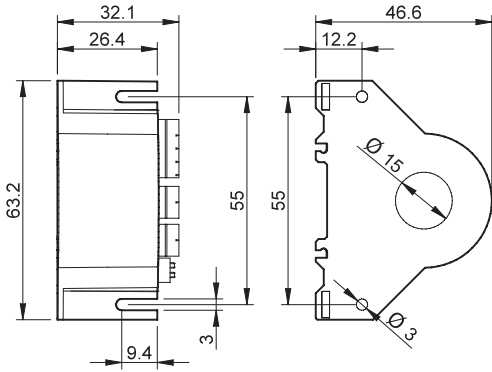

Type 6M.TB

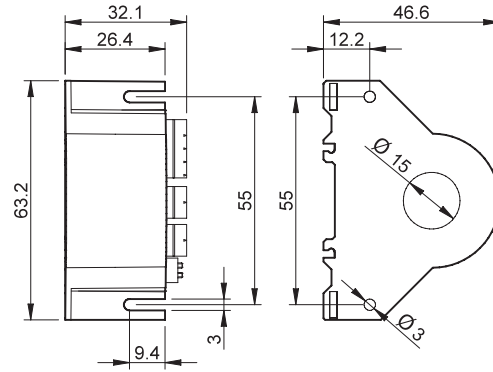

Type 6M.TF

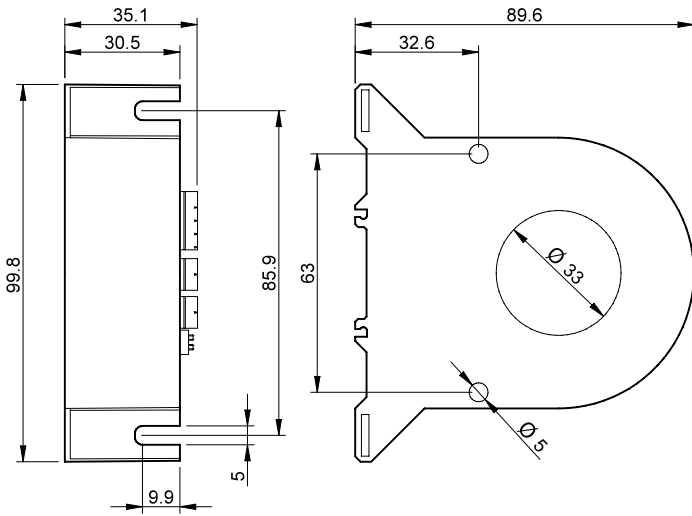

Type 6M.BU

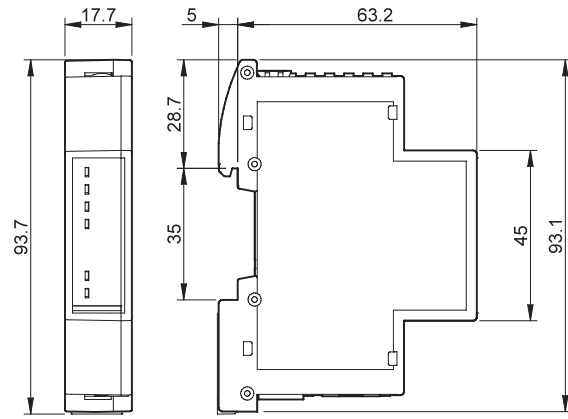

E

# Energy meters

7E  
SERIES



Panels for electrical distribution



Control panels



Electrical energy control



Industrial robots



Road / tunnel lighting



Elevators and lifts





**kWh Energy meter 1-phase with electro-mechanical display and SO pulse output**

**Type 7E.12.8.230.0002**

10 (25) A, kWh, No MID, horizontal display

**Type 7E.13.8.230.0010**

5 (32) A, kWh, MID, 1 module wide

**Type 7E.16.8.230.0010**

10 (65) A, kWh, MID, horizontal display

- Complies with EN 62053-21 and EN 50470
- Accuracy class 1/B
- Protection class II
- SO pulse output for remote energy monitoring according to EN 62053-31
- Tamper-proof cover with lead seal facility available as an accessory
- Space saving small size
- 35 mm rail (EN 60715) mount

**7E.12.8.230.0002**



- Nominal current 10 A (25 A Maximum)
- 1-phase 230 V AC
- SO pulse output
- 35 mm wide

**7E.13.8.230.0010**



- Nominal current 5 A (32 A Maximum)
- MID certified (50 Hz)
- 1-phase 230 V AC
- SO pulse output
- 17.5 mm wide

**7E.16.8.230.0010**



- Nominal current 10 A (65 A Maximum)
- MID certified (50 Hz)
- 1-phase 230 V AC
- SO pulse output
- 35 mm wide

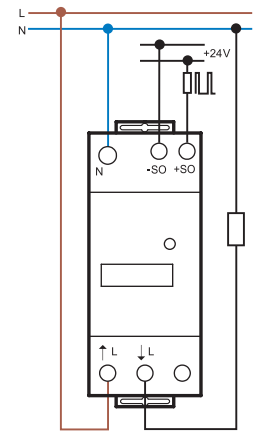
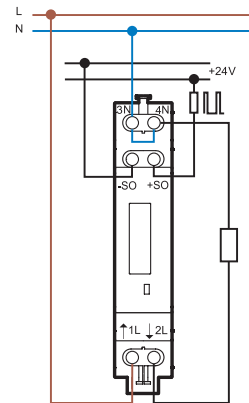
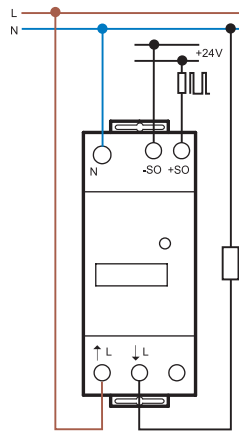

For outline drawing see page 15

**Specification**

Nominal/Maximum current	A	10/25	5/32	10/65
Minimum measured current	A	0.04	0.02	0.04
Current range (within accuracy class)	A	0.5...25	0.25...32	0.5...65
Maximum peak current	A	750 (10 ms)	960 (10 ms)	1950 (10 ms)
Supply (& monitored) voltage (U <sub>N</sub> )	V AC	230	230	230
Operating range		(0.8...1.15)U <sub>N</sub>	(0.8...1.15)U <sub>N</sub>	(0.8...1.15)U <sub>N</sub>
Frequency	Hz	50	50	50
Power consumption	W	< 0.5	< 0.4	< 0.5
Display (digit height 4 mm)		Six digit counter, red decimal digit	Seven digit counter, red decimal digit	
Max. totalising count/Min. increment	kWh	99 999.9/0.1	999 999.9/0.1	999 999.9/0.1
LED-Pulses per kWh		2000	2000	1000
<b>Open collector- output specification (SO+/SO-)</b>				
Voltage (external supply)	V DC	5...30	5...30	5...30
Maximum current	mA	20	20	20
Maximum leakage current @ 30 V/25 °C	µA	10	10	10
Pulses per kWh		1000	1000	1000
Pulse length	ms	50	50	50
Internal series resistance	Ω	100	100	100
Maximum cable length @ 30 V/20 mA	m	1000	1000	1000
<b>Technical data</b>				
Accuracy class		1	B	B
Ambient temperature (Within accuracy class)	°C	-10...+55	-10...+55	-10...+55
Protective class		II	II	II
Protection category: Housing/terminals		IP 50/IP 20	IP 50/IP 20	IP 50/IP 20
<b>Approvals (according to type)</b>				

**kWh Energy meter 3-phase  
MID with electromechanical display and SO  
pulse output**

**Type 7E.36.8.400.0010**

**10 (65) A, kWh, MID**

**Type 7E.36.8.400.0012**

**10 (65) A, kWh, dual tariff, MID**

- Complies with EN 62053-21 and EN 50470
- Accuracy class B
- Protection class II
- SO pulse output for remote energy monitoring according to EN 62053-31
- Tamper-proof cover with lead seal facility available as an accessory
- 35 mm rail (EN 60715) mount

**7E.36.8.400.0010**



- Nominal current 10 A (65 A Maximum)
- MID certified (50 Hz)
- 3-phase
- SO pulse output
- 70 mm wide

**7E.36.8.400.0012**



- Nominal current 10 A (65 A Maximum)
- MID certified (50 Hz)
- 3-phase
- SO pulse output
- Dual tariff (Day and Night)
- 70 mm wide

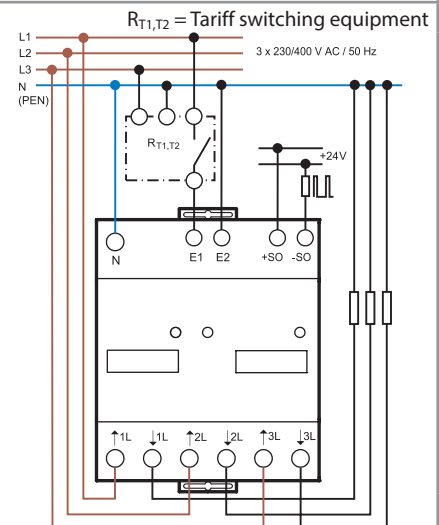
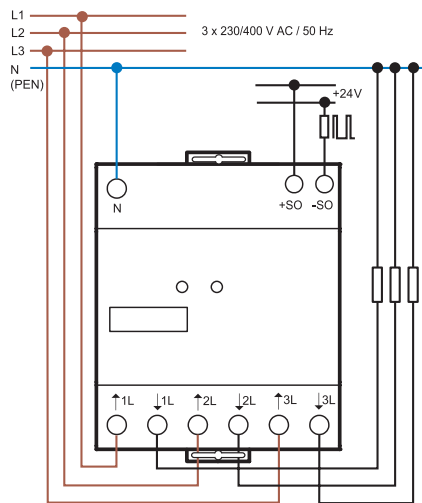

For outline drawing see page 15

**Specification**

Nominal/Maximum current	A	10/65	10/65
Minimum measured current	A	0.04	0.04
Current range (within accuracy class)	A	0.5...65	0.5...65
Maximum peak current	A	1950 (10 ms)	1950 (10 ms)
Supply (& monitored) voltage (U <sub>N</sub> )	V AC	3 x 230	3 x 230
Operating range		(0.8...1.15)U <sub>N</sub>	(0.8...1.15)U <sub>N</sub>
Frequency	Hz	50	50
Power consumption per phase	W	< 1.5	< 1.5

Display (digit height 4 mm)	Seven digit counter, red decimal digit		
Max. totalising count/Min. increment	kWh	999 999.9/0.1	999 999.9/0.1
LED-Pulses per kWh		100	100

**Open collector- output specification (SO+ / SO-)**

Voltage (external supply)	V DC	5...30	5...30
Maximum current	mA	20	20
Maximum leakage current @ 30 V/25 °C	µA	10	10
Pulses per kWh		100	100
Pulse length	ms	50	50
Internal series resistance	Ω	100	100
Maximum cable length @ 30 V/20 mA	m	1000	1000

**Technical data**

Accuracy class		B	B
Ambient temperature	°C	-10...+55	-10...+55
Protective class		II	II
Protection category: Housing/terminals		IP 50/IP 20	IP 50/IP 20

**Approvals** (according to type)



**Single-phase**

**Single-phase Bi-directional energy meters with backlit LCD display**

**Type 7E.64.8.230.0001**

**kWh, kW, V**

- Display of active energy consumption (kWh)
- Scroll to view instantaneous voltage (V) and active power (kW)
- 7 digit backlit LCD display
- Class 1 accuracy according to EN 62053-21
- SO output for remote energy monitoring according to EN 62053-31. Active energy (kWh) only

**Type 7E.64.8.230.0010**

**Multifunction MID certified**

- Display of total or partial (resettable) energy consumption: kWh, kVAh or kvarh
- Scroll to view the following instantaneous values: V, A, PF, kW, kVA, kvar, Hz and direction of power flow
- 7 digit backlit LCD display
- Active power accuracy Class B according to EN 50470-3
- Programmable\* SO pulse output for remote energy monitoring according to EN 62053-31
- Accessories: sealable tamperproof terminal cover
- Protection category II
- 35 mm rail (EN 60715) mount

\* SO output can be associated with kWh, kVAh or kvarh.

For outline drawing see page 15

**Specification**

Reference/Maximum current $I_n/I_{max}$	A	5/40	5/40
Starting current $I_{st}$	A	0.02	0.02
Minimum measured current $I_{min}$	A	0.25	0.25
Current range (within accuracy class)	A	0.5...40	0.5...40
Maximum peak current	A	1200 (10 ms)	1200 (10 ms)
Supply (& monitored) voltage $U_N$	V AC	230	230
Operating range		$(0.8...1.2)U_N$	$(0.8...1.2)U_N$
Frequency	Hz	50/60	50/60
Power consumption	W/VA	$\leq 0.5/1.5$	$\leq 0.5/1.5$
Display		Seven digit counter - backlit LCD display	
Max. totalising count/Min. increment	kWh	999 999.9/0.1	999 999.9/0.1
LED pulses per kWh		5000	5000
LED pulse length	ms	4±0.5	4±0.5

**Output specification (SO+/SO-)**

Number/Type		1 opto-isolated output	1 opto-isolated output
Voltage range/Maximum current (conforming to EN 62053-1)	V DC/mA	3.3...27/1...27	3.3...27/1...27
Pulses per kWh*	Imp/kWh*	1000	1000
Pulse length	ms	100 ± 0.5	100 ± 0.5
Maximum cable length	m	1000	1000

**Technical data**

Accuracy class EN 62053-21 (non MID)/ EN 50470-3 (MID)		1	B
Ambient temperature (Within accuracy class)	°C	-25...+55	-25...+55
Protective class		II	II
Protection category: Housing/terminals		IP 50/IP 20	IP 50/IP 20

**Approvals (according to type)**



**7E.64.8.230.0001**



- Reference current 5 A (40 A Maximum)
- 1-phase 230 V AC
- kWh + instantaneous voltage & kW, V

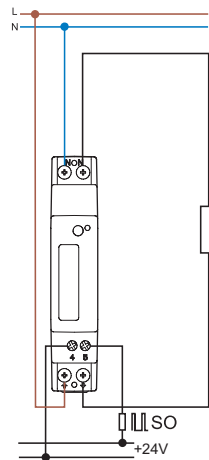

**7E.64.8.230.0010**



- Reference current 5 A (40 A Maximum)
- 1-phase 230 V AC
- kWh, kVAh or kvarh + instantaneous V, A, PF, kW, kVA, kvar & Hz
- MID certified

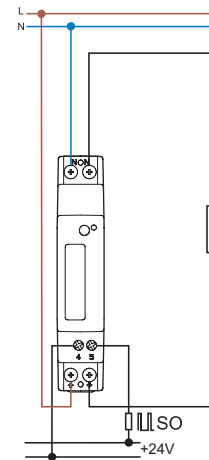

**Three-phase**

**Multifunction Dual tariff energy meters**  
**Bi-directional, MID certified, two SO outputs**  
**with backlit LCD display for 3 or 4 wire systems**  
**Infra-red communications port**

**Type 7E.78.8.400.0112**

**Direct connection up to 80 A, dual tariff**

**Type 7E.86.8.400.0112**

**6 A direct connection, up to 50 000 A using**  
**current transformer, dual tariff**

- Display of total or partial (resettable) energy consumption: kWh, kVAh or kvarh - for both T1 and T2 tariffs - for the total system or per phase
- Scroll to view the following instantaneous values: V, A, PF, kW, kVA, kvar, Hz and direction of power flow
- Fault indication in the event of loss or incorrect phase sequence
- 8 digit backlit LCD display
- Active power accuracy Class B according to EN 50470-3
- Reactive power accuracy Class 2 according to EN 62053-23
- Two programmable\*\* SO pulse outputs for remote energy monitoring according to EN 62053-31
- Infra-red communications port for data exchange with various field protocols, using optional modules
- Protection category II
- Accessories: sealable tamperproof terminal cover
- 35 mm rail (EN 60715) mount

\* Minimum CT ratio: 1:1  
 Maximum CT ratio: 10 000:1  
 CT full scale programmable: 1 or 5 A  
 \*\* SO output can be associated with kWh, kVAh or kvarh.

For outline drawing see page 15

**Specification**

Reference/Maximum current $I_n/I_{max}$	A	5/80	1/6
Starting current $I_{st}$	A	0.02	0.002
Minimum measured current $I_{min}$	A	0.25	0.01
Current range (within accuracy class)	A	0.5...80	0.05...6
Maximum peak current	A	2400 (10 ms)	120 (500 ms)
Supply (& monitored) voltage $U_N$	V AC	3 x 230/400...3 x 240/415	3 x 230/400...3 x 240/415
Operating range		$(0.8...1.2)U_N$	$(0.8...1.2)U_N$
Frequency	Hz	50/60	50/60
Power consumption per phase	W/VA	$\leq 0.5/7.5$	$\leq 0.5/7.5$
CT burden (per phase)	VA	—	0.04

Display	Eight digit counter - backlit LCD display		
Max. totalising count/Min. increment	kWh	999 999.99/0.01	999 999.99/0.01
LED pulses per kWh		1000	10 000
LED pulse length	ms	10±0.5	10±0.5

**Output specification (SO+/SO-)**

Number/Type	2 opto-isolated outputs		2 opto-isolated outputs	
Maximum values (conforming to EN 62053-31)	V AC-DC/mA	250/100	250/100	
Pulses per kWh**	Imp/kWh**	100	See table page 13	
Pulse length	ms	50 ± 2	50 ± 2	
Maximum cable length (30 V/20 mA)	m	1000	1000	

**Tariff input - opto-isolated**

Voltage range	V AC/DC	80...275	80...275
---------------	---------	----------	----------

**Technical data**

Accuracy class EN 50470-3 (MID)		B	B
Ambient temperature	°C	-25...+55 °C	-25...+55 °C
Protective class		II	II
Protection category: Housing/terminals		IP 50/IP 20	IP 50/IP 20

**Approvals (according to type)**



**7E.78.8.400.0112**



- Reference current 5 A (80 A Maximum)
- Three-phase systems - 3 or 4 wire
- Dual tariff
- MID certified

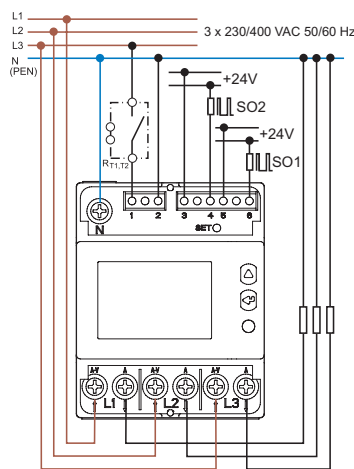

R<sub>T1,T2</sub> = Tariff switching equipment

**7E.86.8.400.0112**



- Reference current 1 A (6 A Maximum)
- Three-phase systems - 3 or 4 wire
- Usable with current transformer\*
- Programmable CT secondary\*
- Dual tariff
- MID certified

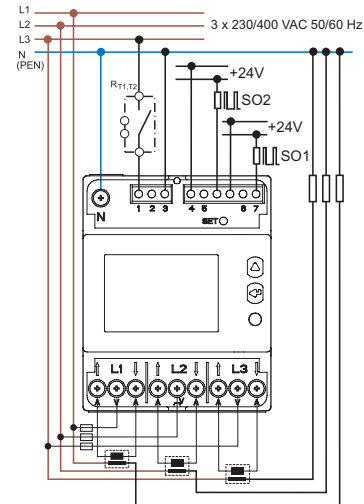

R<sub>T1,T2</sub> = Tariff switching equipment



**Single-phase**

**Multifunction, Bi-directional energy meter  
MID certified with RS485 Modbus integrated  
interface and backlit LCD display**

- Display of total or partial (resettable) energy consumption: kWh, kVAh or kvarh
- Scroll to view the following instantaneous values: V, A, PF, kW, kVA, kvar, Hz and direction of power flow
- 7 digit backlit LCD display
- Active power accuracy Class B according to EN 50470-3
- RS485 Modbus integrated communications port
- Programmable\*\* SO pulse output for remote energy monitoring according to EN 62053-31
- Accessories: sealable tamperproof terminal cover
- Protection category II
- 35 mm rail (EN 60715) mount

\* Default transmission baud rate: 19 200 bps  
\*\* SO output can be associated with kWh, kVAh or kvarh.

**7E.64.8.230.0210**



- Reference current 5 A (40 A Maximum)
- RS485 Modbus integrated interface
- 1-phase 230 V 50/60 Hz
- MID certified

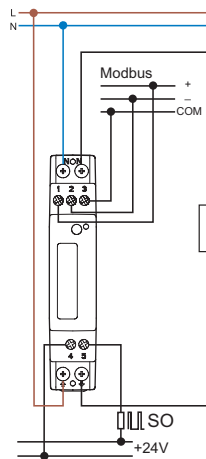

For outline drawing see page 16

**Specification**

Reference/Maximum current $I_N/I_{max}$	A	5/40
Starting current $I_{st}$	A	0.02
Minimum measured current $I_{min}$	A	0.25
Current range (within accuracy class)	A	0.5...40
Maximum peak current	A	1200 (10 ms)
Supply (& monitored) voltage $U_N$	V AC	230
Operating range		$(0.8...1.2)U_N$
Frequency	Hz	50/60
Power consumption	W/VA	$\leq 0.5/1.5$
Display		Seven digit counter - backlit LCD display
Max. totalising count/Min. increment	kWh	999 999.9/0.1
LED pulses per kWh		5000
LED pulse length	ms	$4 \pm 0.5$

**Modbus technical data**

Bus System		RS485 Modbus
Conforms to standard		EIA RS485
Max. bus length	m	1000
Max. Modbus energy meters connectable		32
Baud rate*	Baud	2400, 4800, 9600, 19 200, 38 400

**Output specification (SO+/SO-)**

Number/Type		1 opto-isolated output
Voltage range/Maximum current (conforming to EN 62053-31)	V DC/mA	$3.3...27/1...27$
Pulses per kWh**	Imp/kWh**	1000
Pulse length	ms	$100 \pm 2$

**Technical data**

Accuracy class		B
Ambient temperature (Within accuracy class)	°C	$-25...+55$
Protective class		II
Protection category: Housing/terminals		IP 50/IP 20

**Approvals (according to type)**



**Note regarding energy meters with Modbus interface (Types 7E.64.8.230.0210, 7E.78.8.400.0212 and 7E.86.8.400.0212):**

The energy meter's Modbus protocol contains pre-configured information. Should you need to change any parameter - use the configuration software. The configuration software can be found at [www.findernet.com](http://www.findernet.com)

**Three-phase**

**Multifunction Dual tariff energy meters  
Bi-directional, MID certified with RS485  
Modbus integrated interface, single SO output  
and backlit LCD display for 4 wire systems**

**Type 7E.78.8.400.0212**

**Direct connection up to 80 A, dual tariff**

**Type 7E.86.8.400.0212**

**6 A direct connection, up to 50 000 A using  
current transformer, dual tariff**

- Display of total or partial (resettable) energy consumption: kWh, kVAh or kvarh - for both T1 and T2 tariffs - for the total system or per phase
- Scroll to view the following instantaneous values: V, A, PF, kW, kVA, kvar, Hz and direction of power flow
- Fault indication in the event of loss or incorrect phase sequence
- 8 digit backlit LCD display
- RS485 Modbus integrated communications port
- Programmable\*\*\* SO pulse output for remote energy monitoring according to EN 62053-31
- Active power accuracy Class B according to EN 50470-3
- Reactive power accuracy Class 2 according to EN 62053-23
- Protection category II
- Accessories: sealable tamperproof terminal cover
- 35 mm rail (EN 60715) mount

- \* Minimum CT ratio: 1:1  
Maximum CT ratio: 10 000:1  
CT secondary programmable: 1 or 5 A
- \*\* Default transmission baud rate: 19 200 bps
- \*\*\* SO output can be associated with kWh, kVAh or kvarh.

For outline drawing see page 16

**Specification**

Reference/Maximum current $I_n/I_{max}$	A	5/80	1/6
Starting current $I_{st}$	A	0.02	0.002
Minimum measured current $I_{min}$	A	0.25	0.01
Current range (within accuracy class)	A	0.5...80	0.05...6
Maximum peak current	A	2400 (10 ms)	120 (500 ms)
Supply (& monitored) voltage $U_N$	V AC	3 x 230/400...3 x 240/415	3 x 230/400...3 x 240/415
Operating range		$(0.8...1.2)U_N$	$(0.8...1.2)U_N$
Frequency	Hz	50/60	50/60
Power consumption per phase	W/VA	$\leq 1/3.5$	$\leq 1/3.5$
CT burden (per phase)	VA	—	0.04

Display	Eight digit counter - backlit LCD display		
Max. totalising count/Min. increment	kWh	999 999.99/0.01	999 999.99/0.01
LED pulses per kWh		1000	10 000
LED pulse length	ms	10±0.5	10±0.5

**Modbus technical data**

Bus system		RS485 Modbus	RS485 Modbus
Conforms to standard		EIA RS485	EIA RS485
Max. bus length	m	1000	1000
Max. Modbus energy meters connectable		32	32
Baud rate**	Baud	300...57 600	300...57 600

**Output specification (SO+/SO-)**

Number/Type		1 opto-isolated output	1 opto-isolated output
Voltage range/Maximum current (conforming to EN 62053-31)	V DC/mA	3.3...27/1...27	3.3...27/1...27
Pulse per kWh***	Imp/kWh***	100	See table page 13
Pulse length	ms	50 ± 2	50 ± 2

**Tariff input - opto-isolated**

Voltage range	V AC/DC	80...275	80...275
---------------	---------	----------	----------

**Technical data**

Accuracy class		B	B
Ambient temperature (Within accuracy class)	°C	-25...+55	-25...+55
Protective class		II	II
Protection category: Housing/terminals		IP 50/IP 20	IP 50/IP 20

**Approvals (according to type)**



**7E.78.8.400.0212**



- Reference current 5 A (80 A Maximum)
- RS485 Modbus integrated interface
- Three-phase systems - 4 wire
- Dual tariff
- MID certified

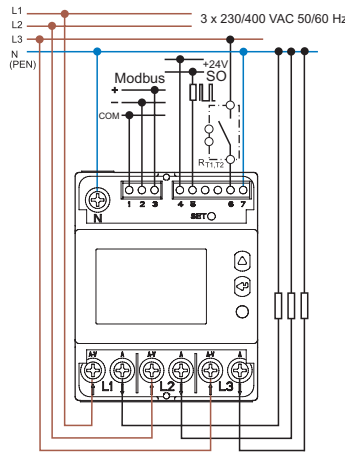

R<sub>T1,T2</sub> = Tariff switching equipment

**7E.86.8.400.0212**



- Reference current 1 A (6 A Maximum)
- RS485 Modbus integrated interface
- Three-phase systems - 4 wire
- Usable with current transformer\*
- Programmable CT secondary\*
- Dual tariff
- MID certified

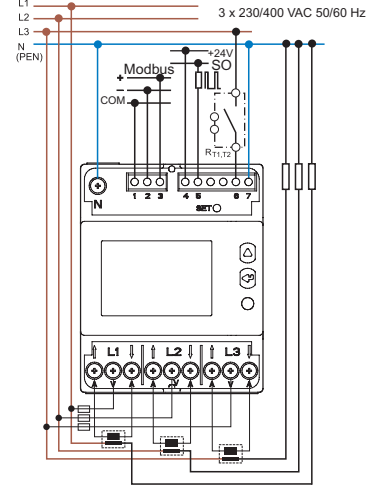

R<sub>T1,T2</sub> = Tariff switching equipment

**Single-phase**

**Multifunction energy meter  
Bi-directional, MID certified with M-Bus  
integrated interface and backlit LCD display**

- Display of total or partial (resettable) energy consumption: kWh, kVAh or kvarh
- Scroll to view the following instantaneous values: V, A, PF, kW, kVA, kvar, Hz and direction of power flow
- 7 digit backlit LCD display
- Active power accuracy Class B according to EN 50470-3
- M-Bus integrated communications port
- Programmable\*\* SO pulse output for remote energy monitoring according to EN 62053-31
- Accessories: sealable tamperproof terminal cover
- Protection category II
- 35 mm rail (EN 60715) mount

\* Default transmission baud rate: 2400 bps  
\*\* SO output can be associated with kWh, kVAh or kvarh.

**7E.64.8.230.0310**



- Reference current 5 A (40 A Maximum)
- M-Bus integrated interface
- 1-phase 230 V 50/60 Hz
- MID certified

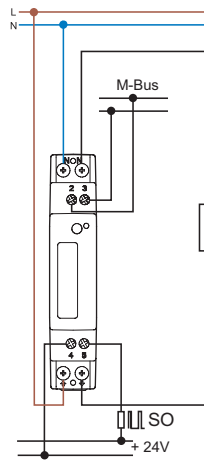

For outline drawing see page 16

Specification		
Reference/Maximum current $I_n/I_{max}$	A	5/40
Starting current $I_{st}$	A	0.02
Minimum measured current $I_{min}$	A	0.25
Current range (within accuracy class)	A	0.5...40
Maximum peak current	A	1200 (10 ms)
Supply (& monitored) voltage $U_N$	V AC	230
Operating range		$(0.8...1.2)U_N$
Frequency	Hz	50/60
Power consumption per phase	W/VA	$\leq 0.5/1.5$
Display		Seven digit counter - backlit LCD display
Max. totalising count/Min. increment	kWh	999 999.9/0.1
LED pulses per kWh		5000
LED pulse length	ms	$4 \pm 0.5$
M-bus technical data		
Bus System		M-Bus
Conforms to standard		EN 13757-1-2-3
Baud rate*	Baud	300, 2400, 9600
Output specification (SO+/SO-)		
Number/Type		1 opto-isolated output
Voltage range/Maximum current (conforming to EN 62053-31)	V DC/mA	3.3...27/1...27
Pulses per kWh**	Imp/kWh**	1000
Pulse length	ms	$100 \pm 0.5$
Technical data		
Accuracy class		B
Ambient temperature (Within accuracy class)	°C	-25...+55
Protective class		II
Protection category: Housing/terminals		IP 50/IP 20
Approvals (according to type)		

**Note regarding energy meters with M-Bus interface (Types 7E.64.8.230.0310, 7E.78.8.400.0312 and 7E.86.8.400.0312):**

The energy meter's M-Bus protocol contains pre-configured information. Should you need to change any parameter - use the configuration software. The configuration software can be found at [www.findernet.com](http://www.findernet.com)

**Three-phase**

**Multifunction Dual tariff energy meters  
Bi-directional, MID certified with M-Bus  
integrated interface, single SO output and  
backlit LCD display for 3 or 4 wire systems**

**Type 7E.78.8.400.0312**

**Direct connection up to 80 A, dual tariff**

**Type 7E.86.8.400.0312**

**6 A direct connection, up to 50 000 A using  
current transformer, dual tariff**

- Display of total or partial (resettable) energy consumption: kWh, kVAh or kvarh - for both T1 and T2 tariffs - for the total system or per phase
- Scroll to view the following instantaneous values: V, A, PF, kW, kVA, kvar, Hz and direction of power flow
- Fault indication in the event of loss or incorrect phase sequence
- 8 digit backlit LCD display
- M-Bus integrated communications port
- Programmable\*\*\* SO pulse output for remote energy monitoring according to EN 62053-31
- Active power accuracy Class B according to EN 50470-3
- Reactive power accuracy Class 2 according to EN 62053-23
- Protection category II
- Accessories: sealable tamperproof terminal cover
- 35 mm rail (EN 60715) mount

- \* Minimum CT ratio: 1:1  
Maximum CT ratio: 10 000:1  
CT secondary programmable: 1 or 5 A
- \*\* Default transmission baud rate: 2400 bps
- \*\*\* SO output can be associate with kWh, kVAh or kvarh.

For outline drawing see page 16

**Specification**

Reference/Maximum current $I_n/I_{max}$	A	5/80	1/6
Starting current $I_{st}$	A	0.02	0.002
Minimum measured current $I_{min}$	A	0.25	0.01
Current range (within accuracy class)	A	0.5...80	0.05...6
Maximum peak current	A	2400 (10 ms)	120 (500 ms)
Supply (& monitored) voltage $U_N$	V AC	3 x 230/400...3 x 240/415	3 x 230/400...3 x 240/415
Operating range		(0.8...1.2) $U_N$	(0.8...1.2) $U_N$
Frequency	Hz	50/60	50/60
Power consumption per phase	W/VA	≤ 0.5/7.5	≤ 0.5/7.5
CT burden (per phase)	VA	—	0.04
Display	Eight digit counter - backlit LCD display		
Max. totalising count/Min. increment	kWh	999 999.99/0.01	999 999.99/0.01
LED pulses per kWh		1000	10 000
LED pulse length	ms	10±0.5	10±0.5
<b>M-bus technical data</b>			
Bus system		M-Bus	M-Bus
Conforms to standard		EN 13757-1-2-3	EN 13757-1-2-3
Baud rate**	Baud	300...9600	300...9600
<b>Output specification (SO+/SO-)</b>			
Number/Type		1 opto-isolated output	1 opto-isolated output
Voltage range/Maximum current (conforming to EN 62053-31)	V DC/mA	3.3...27/1...27	3.3...27/1...27
Pulses per kWh***	Imp/kWh***	100	See table page 13
Pulse length	ms	50 ± 2	50 ± 2
<b>Tariff input - opto-isolated</b>			
Voltage range	V AC/DC	80...275	80...275
<b>Technical data</b>			
Accuracy class		B	B
Ambient temperature (Within accuracy class)	°C	-25...+55	-25...+55
Protective class		II	II
Protection category: Housing/terminals		IP 50/IP 20	IP 50/IP 20

**Approvals** (according to type)



**7E.78.8.400.0312**



- Reference current 5 A (80 A Maximum)
- M-Bus integrated interface
- Three-phase systems programmable 3 or 4 wire
- Dual tariff
- MID certified

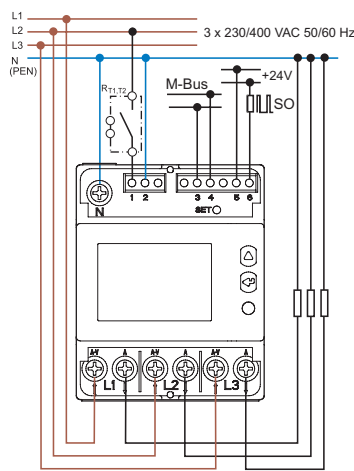

R<sub>T1,T2</sub> = Tariff switching equipment

**7E.86.8.400.0312**



- Reference current 1 A (6 A Maximum)
- M-Bus integrated interface
- Three-phase systems programmable 3 or 4 wire
- Usable with current transformer\*
- Programmable CT secondary\*
- Dual tariff
- MID certified

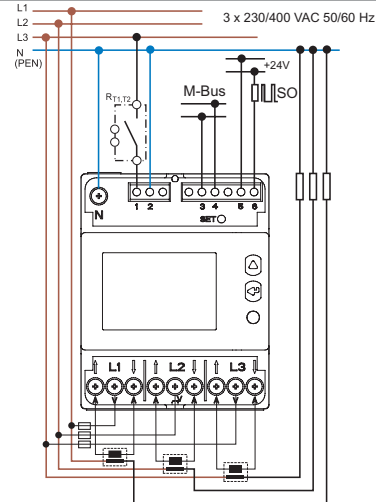

R<sub>T1,T2</sub> = Tariff switching equipment

**Three-phase**

**Multifunction energy meter  
Bi-directional, MID certified with Ethernet  
Modbus TCP integrated interface and backlit  
LCD display for 4 wire systems**

**Type 7E.78.8.400.0410:  
Direct connection up to 80 A**

**Type 7E.86.8.400.0410:  
6 A direct installation, up to 50 000 A using  
current transformer**

- Display of total or partial (resettable) energy consumption: kWh, kVAh or kvarh - for the total system or per phase
- Scroll to view the following instantaneous values: V, A, PF, kW, kVA, kvar, Hz and direction of power flow
- Fault indication in the event of loss or incorrect phase sequence
- 8 digit backlit LCD display
- Ethernet Modbus TCP integrated communications port
- Programmable\*\* SO pulse output for remote energy monitoring according to EN 62053-31
- Active power accuracy Class B according to EN 50470-3
- Reactive power accuracy Class 2 according to EN 62053-23
- Protection category II
- Accessories: sealable terminal cover tamper
- 35 mm rail (EN 60715) mount

- \* Minimum CT ratio: 1:1  
Maximum CT ratio: 10 000:1  
CT secondary programmable: 1 or 5 A
- \*\* SO output can be associate with kWh, kVAh or kvarh.

For outline drawing see page 16

**Specification**

Reference/Maximum current $I_n/I_{max}$	A	5/80	1/6
Starting current $I_{st}$	A	0.02	0.002
Minimum measured current $I_{min}$	A	0.25	0.01
Current range (within accuracy class)	A	0.5...80	0.05...6
Maximum peak current	A	2400 (10 ms)	120 (500 ms)
Supply (& monitored) voltage $U_N$	V AC	3 x 230/400...3 x 240/415	3 x 230/400...3 x 240/415
Operating range		$(0.8...1.2)U_N$	$(0.8...1.2)U_N$
Frequency	Hz	50/60	50/60
Power consumption per phase	W/VA	$\leq 1/3.5$	$\leq 1/3.5$
CT burden (per phase)	VA	—	0.04
Display		Eight digit counter - backlit LCD display	
Max. totalising count/Min. increment	kWh	999 999.99/0.01	999 999.99/0.01
LED pulses per kWh		1000	10 000
LED pulse length	ms	10±0.5	10±0.5
<b>Ethernet technical data</b>			
Bus system		Ethernet TCP	Ethernet TCP
Protocol		Modbus TCP, HTTP, NTP; DHCP	Modbus TCP, HTTP, NTP; DHCP
Conforms to standard		IEEE 802.3	IEEE 802.3
Communication speed	Mbps	10/100	10/100
<b>Open collector- output specification (SO+/SO-)</b>			
Number/Type		1 opto-isolated output	1 opto-isolated output
Voltage range/Maximum current (conform to EN 62053-31)	V DC/mA	3.3...27/1...27	3.3...27/1...27
Pulses per kWh**	Imp/kWh**	100	See table page 13
Pulse length	ms	50 ± 2	50 ± 2
<b>Technical data</b>			
Accuracy class		B	B
Ambient temperature (Within accuracy class)	°C	-25...+55	-25...+55
Protective class		II	II
Protection category: Housing/terminals		IP 50/IP 20	IP 50/IP 20
<b>Approvals</b> (according to type)			

**7E.78.8.400.0410**



- Reference current 5 A (80 A Maximum)
- Ethernet Modbus TCP integrated interface
- Three-phase systems - 4 wire

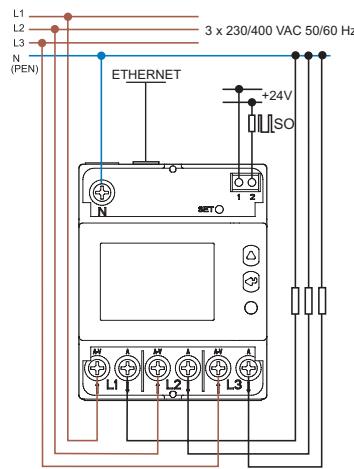

**7E.86.8.400.0410**



- Reference current 1 A (6 A Maximum)
- Ethernet Modbus TCP integrated interface
- Three-phase systems - 4 wire
- Usable with current transformer\*
- Full scale (FSA) programmable\*

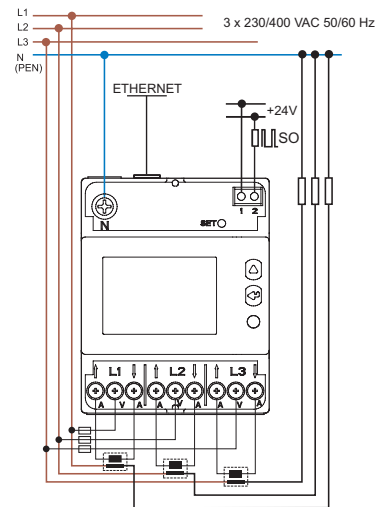

### Ordering information

Example: Energy meter 32 A/230 V AC, with MID certification, Class B accuracy, for 35mm rail (EN 60715) mounting.  
Available with Tamper-proof lead sealed cover as accessory.



**Series**  
**Function**  
1 = 1-phase  
3 = 3-phase  
**Current**  
2 = 25 A  
3 = 32 A  
6 = 65 A  
**Supply version**  
8 = AC 50 Hz

**Option**  
0 = SO +/- pulse output  
**Special version**  
0 = Standard  
1 = MID compliant versions  
**Option**  
0 = Standard  
2 = Standard (7E.12)  
2 = Dual tariff (7E.36)  
**Supply voltage**  
230 = 230 V AC 50 Hz  
400 = 3 x 230/400 V AC 50 Hz  
**All versions/width**  
7E.12.8.230.0002/35 mm  
7E.13.8.230.0010/17.5 mm  
7E.16.8.230.0010/35 mm

7E.36.8.400.0010/70 mm  
7E.36.8.400.0012/70 mm

### E Technical data

<b>Insulation EN 62053-21</b>		<b>7E.12, 7E.13, 7E.16</b>		<b>7E.36</b>	
Insulation rated voltage	V	250		250	
Overvoltage category		IV		IV	
Insulation	between active parts and SO+/SO- terminals	kV (1.2/50 μs)	6	6	
	between adjacent phases	kV (1.2/50 μs)	—	6	
Insulation	between supply and SO+/SO-	V AC	4000	4000	
	between adjacent phases	V AC	—	4000	
Protection class		II		II	
<b>EMC Specification</b>		<b>Reference standard</b>			
Electrostatic discharge	contact discharge	EN 61000-4-2		8 kV	
	air discharge	EN 61000-4-2		15 kV	
Radio-Frequency Electromagnetic Field (80...1000)MHz		EN 61000-4-3		10 V/m	
Fast Transients (Burst) (5-50 ns, 5 kHz)	on Supply terminals	EN 61000-4-4		Class 4 (4 kV)	
	on SO+/SO- terminals	EN 61000-4-4		Class 4 (2 kV)	
Surge (1.2/50 μs)	on Supply terminals	EN 61000-4-5		Class 4 (4 kV)	
	on SO+/SO- terminals	EN 61000-4-5		Class 3 (1 kV)	
Radio-Frequency Common Mode (0.15...80)MHz on Supply terminals		EN 61000-4-6		10 V	
Radiated and Conducted Emission		EN 55022		Class B	
<b>Other data</b>					
Pollution degree		2			
Vibration resistance	(10...60)Hz	mm	0.075		
	(60...150)Hz	g	1		
Vibration resistance of the internal mechanical counter (10...500)Hz	g	2			
Shock resistance	g/18 ms	30			
Shock resistance of the internal mechanical counter	g/18 ms	350			
Power lost to the environment		<b>7E.12, 7E.13</b>	<b>7E.16</b>	<b>7E.36</b>	
	without current	W	0.4	0.4	1.5
with maximum current	W	1	2	6	
<b>Supply terminals</b>		<b>7E.12, 7E.13</b>		<b>7E.16, 7E.36</b>	
Max. wire size		solid cable	stranded cable	solid cable	stranded cable
	mm <sup>2</sup>	1...6	0.75...4	1.5...16	1.5...16
	AWG	18...10	18...12	16...6	16...6
Screw torque for I <sub>max</sub>	Nm	0.8...1.2		1.5...2	
Screw		Pozi driv No.1, Flat No.1, 2			
<b>SO+/SO- terminals</b>					
Max. wire size		solid cable	stranded cable	solid cable	stranded cable
	mm <sup>2</sup>	2.5	1.5	2.5	1.5
	AWG	14	16	14	16
Screw torque for I <sub>max</sub>	Nm	0.5		0.8	
Screw		Pozi driv No.0, Flat No.1		Pozi driv No.0, Flat No.2	



## Ordering information - Energy meter

Example: 3-phase energy meter for current transformer operation (6A/400 V AC), with MID certification, Class B accuracy, for 35 mm rail (EN 60715) mounting. Supplied accessories: Tamper-proof lead sealed cover as accessory.

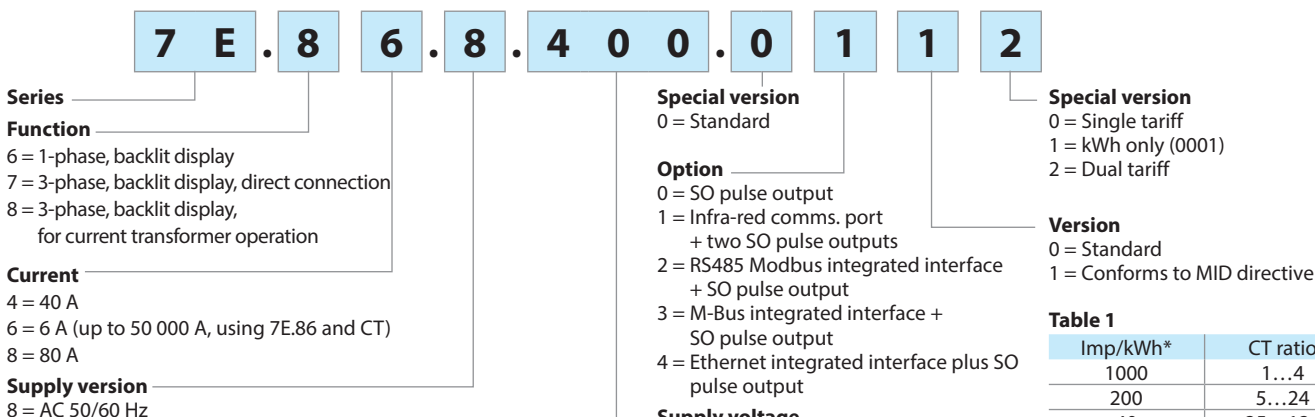

**Table 1**

Imp/kWh*	CT ratio
1000	1...4
200	5...24
40	25...124
8	125...624
1	625...3124
0.1	3125...10 000

\*Imp/kWh, Imp/kvarh, Imp/kVAh

### Available versions

Infra-red comms. port for use with communication modules

	Modbus	M-Bus	Ethernet	SO only
7E.78.8.400.0112	7E.64.8.230.0210	7E.64.8.230.0310	7E.78.8.400.0410	7E.64.8.230.0001
7E.86.8.400.0112	7E.78.8.400.0212	7E.78.8.400.0312	7E.86.8.400.0410	7E.64.8.230.0010
	7E.86.8.400.0212	7E.86.8.400.0312		

## Technical data

Insulation		7E.64.8.230.0xxx	7E.78.8.400.0xxx	7E.86.8.400.0xxx
Insulation rated voltage		V	250	250
Insulation	between active parts and SO+/SO- terminals	kV (1.2/50 μs)	6	
	between supply and Modbus, M-Bus terminal	kV (1.2/50 μs)	6	
	between adjacent phases	kV (1.2/50 μs)	n/a	
Insulation	between active parts and SO+/SO- terminals	V AC	4000	
	between supply and Modbus, M-Bus terminal	V AC	4000	
	between adjacent phases	V AC	n/a	
Protection class		II		
EMC Specification according to 61000-4-(2/3/4)		7E.64.8.230.0xxx	7E.78.8.400.0xxx	7E.86.8.400.0xxx
Electrostatic discharge	contact discharge	8 kV		
	air discharge	15 kV		
Radio frequency Electromagnetic field (80...2000)MHz		30 V/m		
Fast Transients (burst) (5-50 ns, 5 kHz)	on Supply terminals	4 kV		
	on SO+/SO- terminals	2 kV		
	Modbus, M-Bus terminal	2 kV		
Surge (1.2/50 μs)	on Supply terminals	4 kV		
	on SO+/SO- terminals	1 kV		
	Modbus, M-Bus terminal	1 kV		
Other data		7E.64.8.230.0xxx	7E.78.8.400.0xxx	7E.86.8.400.0xxx
Pollution degree		2		
Vibration resistance		EN 60068-2-6	EN 60068-2-6	EN 60068-2-6
Shock resistance		EN 60068-2-27	EN 60068-2-27	EN 60068-2-27
Power lost to the environment	Max value per phase	0.5W/1.5 VA	1W/7.5VA	1W/7.5VA
	CT burden	—	—	0.04 VA/per phase
Supply terminals		7E.64.8.230.0xxx	7E.78.8.400.0xxx	7E.86.8.400.0xxx
Max. wire size	mm <sup>2</sup>	solid cable	solid cable	solid cable
		stranded cable	stranded cable	stranded cable
	AWG	—	—	—
Screw torque for I <sub>max</sub>	mm <sup>2</sup>	max 6	max 35	max 6
		1.5...6	1.5...35	1.5...6
	AWG	—	—	—
SO+/SO- terminals, RS485 Modbus, M-Bus		7E.64.8.230.0xxx	7E.78.8.400.0xxx	7E.86.8.400.0xxx
Max. wire size	mm <sup>2</sup>	solid cable	solid cable	solid cable
		stranded cable	stranded cable	stranded cable
	AWG	—	—	—
Screw torque	mm <sup>2</sup>	max 2.5	max 2.5	max 2.5
	AWG	—	—	—
Screw torque	Nm	0.5	0.5	0.5
	Nm	0.5	0.5	0.5

## Mechanical Display Type 7E.12, 7E.13, 7E.16, 7E.36

### LED indication (Normal operation)

Type	Energy consumption			Pulses per kWh	Pulse space	The LED Pulse rate represents the instantaneous power being consumed, according to the following
	None	Low	High			
7E.12 7E.13				2000	100 ms	$kW = (\text{number of pulse per Minute}) / 33.3$
7E.16				1000	100 ms	$kW = (\text{number of pulse per Minute}) / 16.7$
7E.36				100	150 ms	$kW = (\text{number of pulse per Minute}) / 1.7$

### LED indication (Abnormal operation)

Status indicates errors of installation, as below

#### Type 7E.12, 7E.13, 7E.16

Device ON, incorrect connection (L-N inverted).  
Mark = 600 ms, Space = 600 ms



#### Type 7E.36

Mark = 100 ms,  
Phase L1↑ L1↓ inverted  
or loss

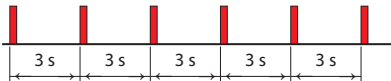

Phase L1↑ L1↓ and L2↑ L2↓  
inverted or loss

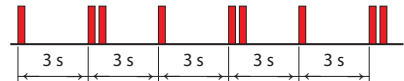

Phase L2↑ L2↓ inverted  
or loss

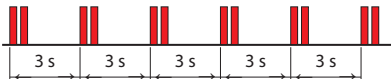

Phase L1↑ L1↓ and L3↑ L3↓  
inverted or loss

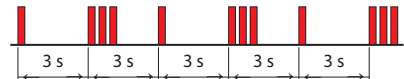

Phase L3↑ L3↓ inverted  
or loss

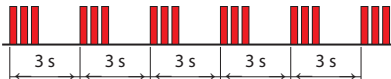

Phase L2↑ L2↓ and L3↑ L3↓  
inverted or loss

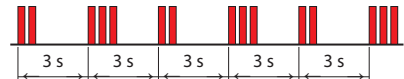

Phase L1↑ L1↓ and L2↑ L2↓  
and L3↑ L3↓ inverted or loss

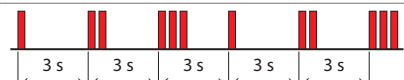

## SO+/SO- Open collector output wiring diagram Type 7E.12, 7E.13, 7E.16, 7E.36

The pulsating open collector output available at terminals SO+ and SO- can be interfaced with the input of a computer, plc or other energy management equipment to allow the remote monitoring of energy consumed.

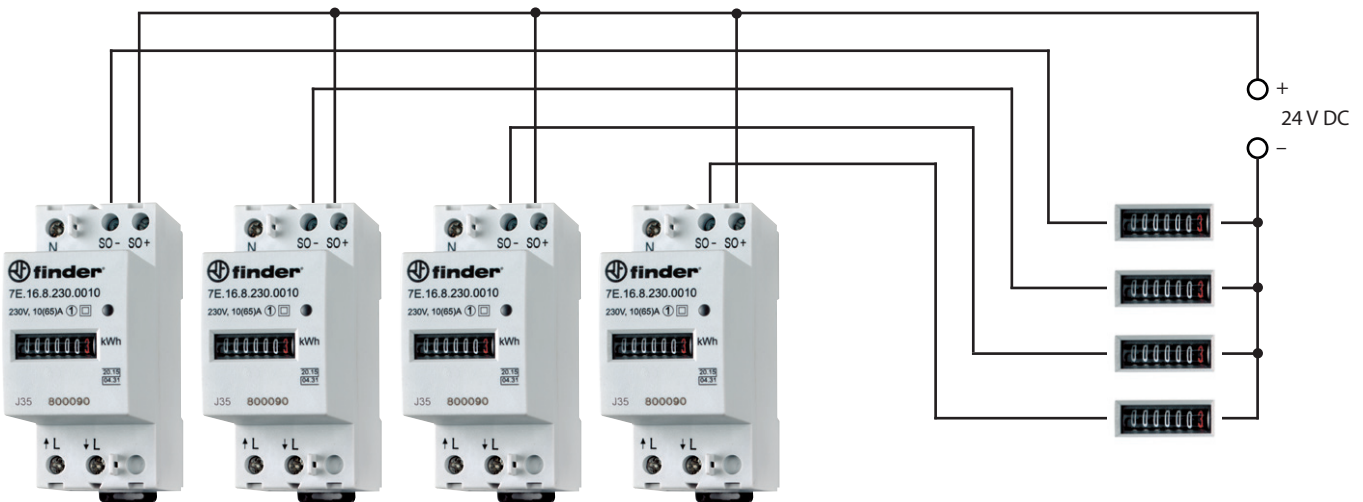

Energy meters – at difference locations  
(Note: Both Single and Dual tariff meters provide only a single pulsating output)

Central monitoring/management system  
(max. 20 mA for each input)

### SO-Output Type 7E.12, 7E.13, 7E.16

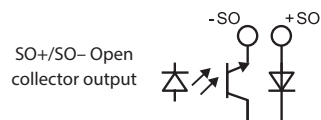

### SO-Output Type 7E.36

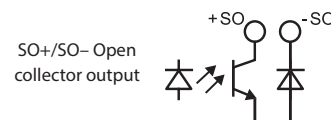



Outline drawings

Type 7E.12.8.230.0002/7E.16.8.230.0010

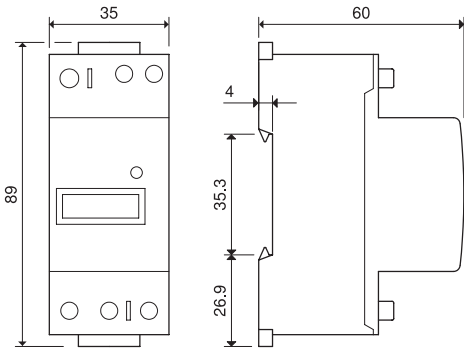

Type 7E.13.8.230.0010

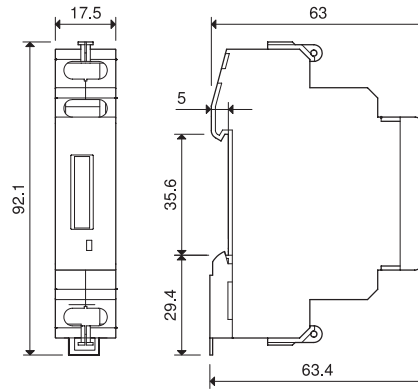

Type 7E.36.8.400.0010

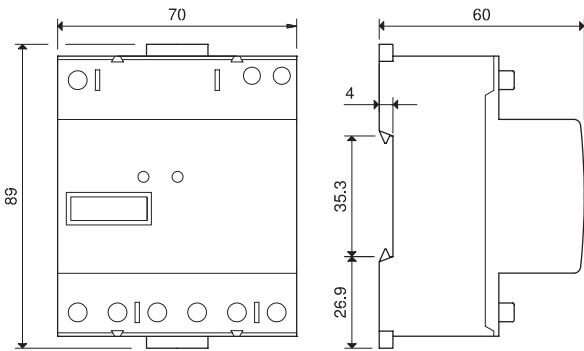

Type 7E.36.8.400.0012

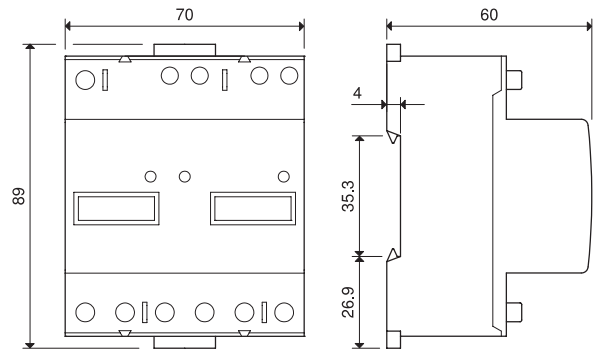

Type 7E.64.8.230.0001

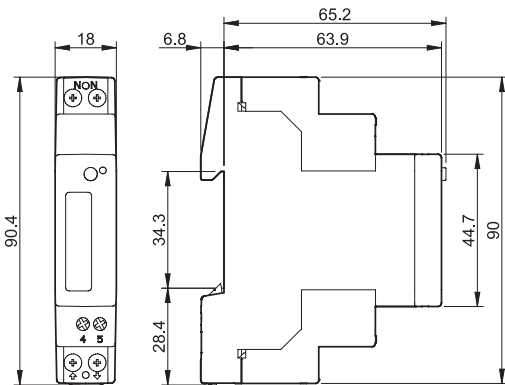

Type 7E.64.8.230.0010

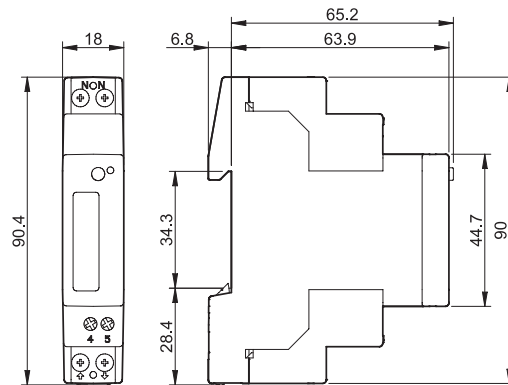

Type 7E.78.8.400.0112

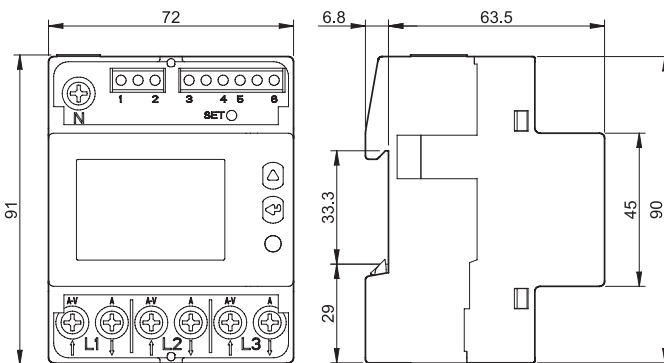

Type 7E.86.8.400.0112

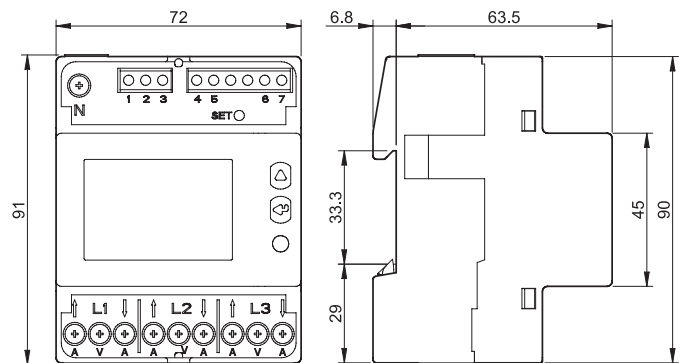

Outline drawing

Type 7E.64.8.230.0210

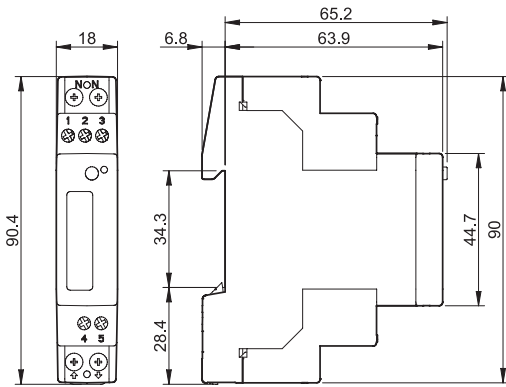

Type 7E.64.8.230.0310

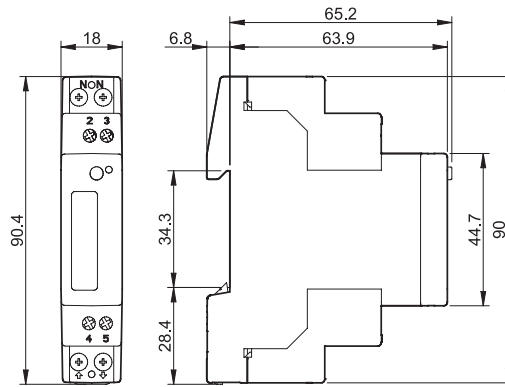

Type 7E.78.8.400.0212

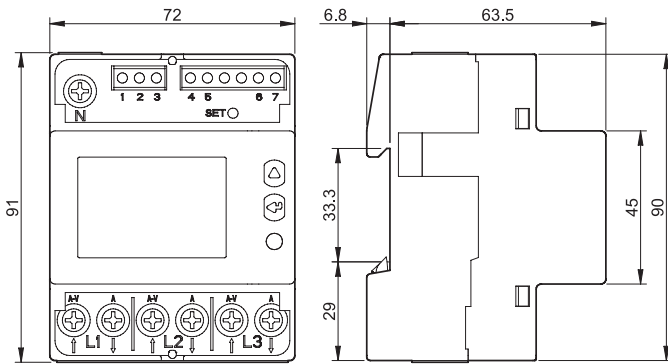

Type 7E.86.8.400.0212

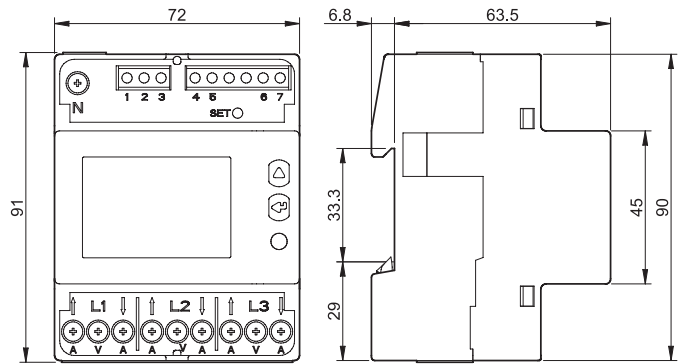

Type 7E.78.8.400.0312

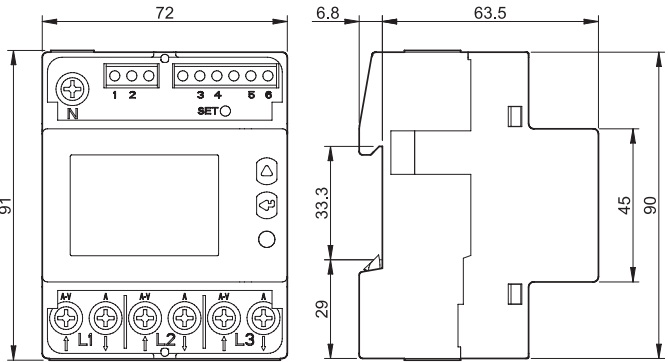

Type 7E.86.8.400.0312

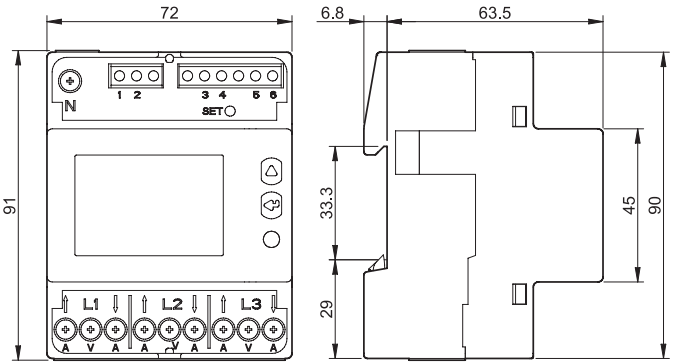

Type 7E.78.8.400.0410

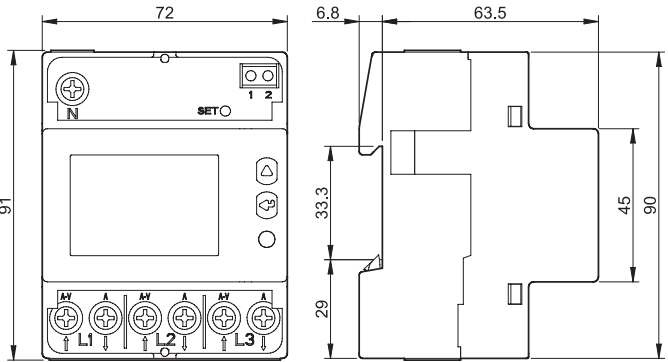

Type 7E.86.8.400.0410

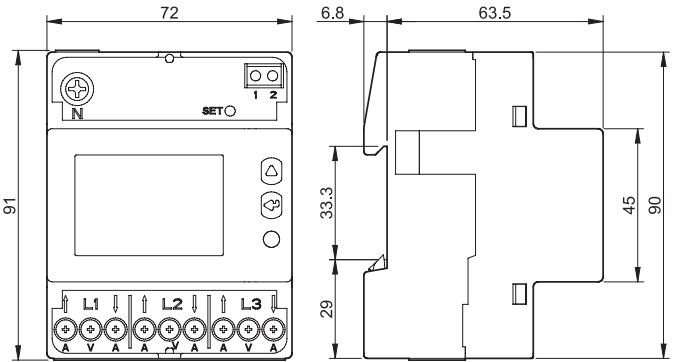

E

## Accessories



07E.13

**Terminal cover** for type 7E.13

07E.13

For the tamper-proof lead seal use two terminal covers



07E.16

**Terminal cover** for type 7E.12, 7E.16 and 7E.36

07E.16

7E.12, 7E.16 - For the tamper-proof lead seal use two terminal covers

7E.36 - For the tamper-proof lead seal use four terminal covers

## Terms and definitions

$I$	The electrical current flowing through the meter
$I_n$	The specified reference current for which the meter has been designed
$I_{st}$	The lowest declared value of " $I$ " at which the meter registers active electrical energy at unity power factor (polyphase meters with balanced load)
$I_{min}$	The values of " $I$ " above which the error lies within maximum permissible errors (MPEs) (polyphase meters with balanced load)
$I_{tr}$	The value of " $I$ " above which the error lies within the smallest MPE corresponding to the class index of the meter
$I_{max}$	The maximum value of " $I$ " for which the error lies within the MPEs

E

Detailed structure of the protocol is available on line



# SMART Energy meters

7M  
SERIES

 Panels for electrical distribution

 Control panels

 Electrical energy control

 Industrial robots

 Inverter

 Charging Stations

 PV applications





**Single-phase energy meter  
with backlit LCD display**

**Type 7M.24.8.230.0001**

**S0 pulse output  
kWh energy meter**

- Display of active energy consumption (kWh)
- Active power accuracy Class B according to EN 50470-3
- S0 pulse output for remote energy monitoring according to EN 62053-31
- Sealable tamperproof terminal shield
- Protection category II
- 35 mm rail (EN 60715) mount

**NEW 7M.24.8.230.0001**



- Reference current 5 A (40 A Maximum)
- S0 pulse output
- 1-phase 230 V AC
- kWh

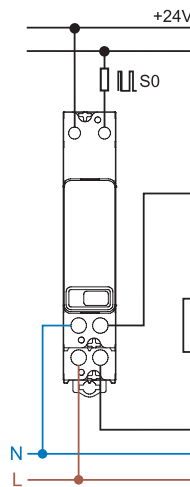

For outline drawing see page 14

**Specification**

Reference/Maximum current $I_n/I_{max}$	A	5/40
Starting current $I_{st}$	A	0.02
Minimum measured current $I_{min}$	A	0.25
Current range (within accuracy class)	A	0.5...40
Maximum peak current	A	1200 (10 ms)
Supply (& monitored) voltage $U_N$	V AC	230
Operating range		$(0.8...1.15)U_N$
Frequency	Hz	50/60
Power consumption	W/VA	$\leq 0.5/1.5$
Display		LCD
Max. totalising count/Min. increment	kWh	999 999.9/0.1
LED pulses per kWh		1000
LED pulse length	ms	$4 \pm 0.5$

**Output specification (S0+/S0-)**

Number/Type		1 opto-isolated output
Voltage range/Maximum current (conforming to EN 62053-1)	V DC/mA	3.3...27/1...27
Pulses per kWh	Imp/kWh	1000
Pulse length	ms	$32 \pm 2$
Maximum cable length	m	1000

**Technical data**

Accuracy class EN 50470-3 (MID)		B
Ambient temperature (Within accuracy class)	°C	-25...+55
Protective class		II
Protection category: Housing/terminals		IP 50/IP 20

**Approvals** (according to type)



**Single-phase Bi-directional energy meters with backlit LCD display  
Multi-function and MID certified**

**Type 7M.24.8.230.0010  
S0 pulse output**

**Type 7M.24.8.230.0110 (with NFC)  
S0 pulse output, IR communication port  
NFC technology allows to program and  
customize the counters via smartphone and  
also reading the measured energy even in the  
absence of mains voltage**

- Display of total or partial (resettable) consumption: kWh, kVAh, kvarh
- 2 active energy MID counters + 2 reactive energy nationally certified counters
- 8 resettable counters
- Scroll to view the following instantaneous values: V, A, PF, kW, kVA, kvar, Hz, THD V, THD A, phase angle and direction of power flow
- 7 digit backlit LCD display
- Multi-function touch button
- Active energy accuracy Class B according to EN 50470-3 (MID)
- Reactive energy accuracy Class 2 to EN 62053-23
- S0 pulse output for remote energy monitoring according to EN 62053-31
- Sealable tamperproof terminal shield
- Protection category II
- 35 mm rail (EN 60715) mount

**NEW 7M.24.8.230.0010**



- Reference current 5 A (40 A Maximum)
- S0 pulse output
- 1-phase 230 V 50/60 Hz
- MID certified

**NEW 7M.24.8.230.0110**



- Reference current 5 A (40 A Maximum)
- S0 pulse output, IR communication port and NFC
- 1-phase 230 V 50/60 Hz
- MID certified

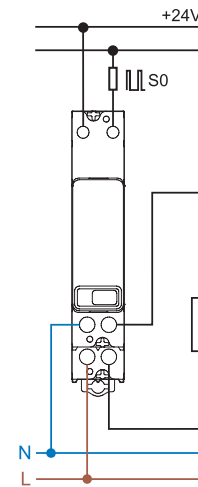
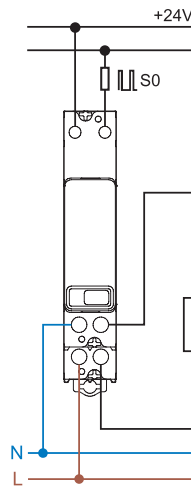

For outline drawing see page 14

**Specification**

Reference/Maximum current $I_N/I_{max}$	A	5/40	5/40
Starting current $I_{st}$	A	0.02	0.02
Minimum measured current $I_{min}$	A	0.25	0.25
Current range (within accuracy class)	A	0.5...40	0.5...40
Maximum peak current	A	1200 (10 ms)	1200 (10 ms)
Supply (& monitored) voltage $U_N$	V AC	230	230
Operating range		$(0.8...1.15)U_N$	$(0.8...1.15)U_N$
Frequency	Hz	50/60	50/60
Power consumption	W/VA	$\leq 0.5/1.5$	$\leq 0.5/1.5$
Display		LCD	LCD
Max. totalising count/Min. increment	kWh	999 999.9/0.1	999 999.9/0.1
LED pulses per kWh		1000	1000
LED pulse length	ms	$4\pm 0.5$	$4\pm 0.5$
<b>Output specification (S0+/S0-)</b>			
Number/Type		1 opto-isolated output	1 opto-isolated output
Voltage range/Maximum current (conforming to EN 62053-1)	V DC/mA	3.3...27/1...27	3.3...27/1...27
Pulses per kWh	Imp/kWh	1000	1000
Pulse length	ms	$32 \pm 2$	$32 \pm 2$
Maximum cable length	m	1000	1000
<b>Technical data</b>			
Accuracy class IEC EN 50470-3 / IEC EN 62053-23		1/2	1/2
Ambient temperature (Within accuracy class)	°C	-25...+55	-25...+55
Protective class		II	II
Protection category: Housing/terminals		IP 50/IP 20	IP 50/IP 20
<b>Approvals (according to type)</b>			



**Single-phase Bi-directional energy meters with NFC technology , MID certification and LCD display**  
**IR comms port + Modbus/M-Bus interface**

**Type 7M.24.8.230.0210 (with NFC)**  
**Multi-function energy meter**  
**Bi-directional, MID certified with RS485**  
**Modbus integrated interface**

**Type 7M.24.8.230.0310 (with NFC)**  
**Multi-function energy meter**  
**Bi-directional, MID certified with M-Bus**  
**integrated interface**

**NFC technology allows to program and customize the counters via smartphone and also reading the measured energy even in the absence of mains voltage**

- Display of total or partial (resettable) consumption: kWh, kVAh, kvarh
- 2 active energy MID counters + 2 reactive energy nationally certified counters
- 8 resettable counters
- Scroll to view the following instantaneous values: V, A, PF, kW, kVA, kvar, Hz, THD V, THD A, phase angle and direction of power flow
- 7 digit backlit LCD display
- Multi-function touch button
- Active energy accuracy Class B according to EN 50470-3 (MID)
- Reactive energy accuracy Class 2 to EN 62053-23
- Sealable tamperproof terminal shield
- Protection category II
- 35 mm rail (EN 60715) mount

\* Modbus default transmission baud rate: 19200 bps  
M-Bus default transmission baud rate: 2400 bps

For outline drawing see page 14

**Specification**

Reference/Maximum current $I_N/I_{max}$	A	5/40	5/40
Starting current $I_{st}$	A	0.02	0.02
Minimum measured current $I_{min}$	A	0.25	0.25
Current range (within accuracy class)	A	0.5...40	0.5...40
Maximum peak current	A	1200 (10 ms)	1200 (10 ms)
Supply (& monitored) voltage $U_N$	V AC	230	230
Operating range		$(0.8...1.15)U_N$	$(0.8...1.15)U_N$
Frequency	Hz	50/60	50/60
Power consumption	W/VA	$\leq 0.5/1.5$	$\leq 0.5/1.5$
Display		LCD	LCD
Max. totalising count/Min. increment	kWh	999 999.9/0.1	999 999.9/0.1
LED pulses per kWh		1000	1000
LED pulse length	ms	4±0.5	4±0.5
<b>Technical data communication protocol</b>			
Bus System		Modbus RS485	M-Bus
Frame (default)		8, N, 2	—
Max bus length	m	1000	—
Baud rate*	Baud	1200...115 200	300...9600
<b>Technical data</b>			
Accuracy class IEC EN 50470-3 / IEC EN 62053-23		1/2	1/2
Ambient temperature (Within accuracy class) °C		-25...+70	-25...+55
Protective class		II	II
Protection category: Housing/terminals		IP 50/IP 20	IP 50/IP 20
<b>Approvals (according to type)</b>			

**NEW 7M.24.8.230.0210**



- Reference current 5 A (40 A Maximum)
- Modbus integrated interface and IR communication port and NFC technology
- 1-phase 230 V 50/60 Hz
- MID certified

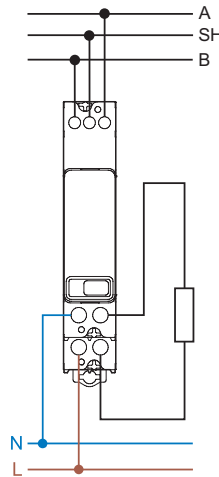

**NEW 7M.24.8.230.0310**



- Reference current 5 A (40 A Maximum)
- M-Bus integrated interface and IR communication port and NFC technology
- 1-phase 230 V 50/60 Hz
- MID certified

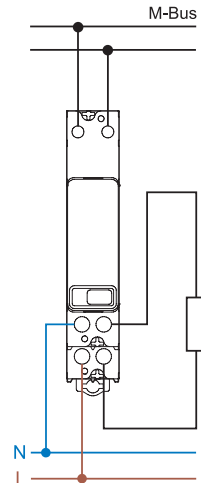

**Three-phase multi-function Bi-directional energy meters with NFC technology and backlit Matrix LCD display. MID certified for 3 or 4 wire system and single phase application up to 80 A @ 70°C.**

**Type 7M.38.8.400.0112 (with NFC)**

**Direct connection up to 80 A, dual tariff, two SO pulse output**

**NFC technology allows to program and customize the counters via smartphone and also reading the measured energy even in the absence of mains voltage**

- Display of total or partial (resettable) consumption: kWh, kVAh, kvarh
- 2 active energy MID counters + 2 reactive energy nationally certified counters
- 16 resettable counters
- Scroll to view the following instantaneous values: V, A, PF, kW, kVA, kvar, Hz, THD V, THD A, phase angle and direction of power flow
- Two SO pulse outputs for remote energy monitoring according to EN 62053-31
- Matrix backlit LCD display
- Multi-function touch button
- Active energy accuracy Class B according to EN 50470-3 (MID)
- Reactive energy accuracy Class 2 to EN 62053-23
- Sealable tamperproof terminal shield
- Protection category II
- 35 mm rail (EN 60715) mount

**NEW 7M.38.8.400.0112**



- Reference current 5 A (80 A Maximum)
- Three phase system 3 or 4 wire or single phase
- Dual SO outputs and IR communication port and NFC technology
- MID certified up to 70°C

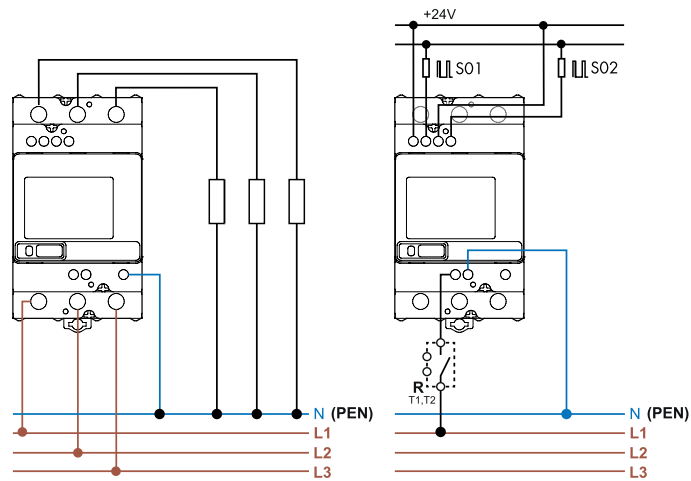

For outline drawing see page 15

**Specification**

Reference/Maximum current $I_n/I_{max}$	A	5/80
Starting current $I_{st}$	A	0.02
Minimum measured current $I_{min}$	A	0.25
Current range (within accuracy class)	A	0.5...80
Maximum peak current	A	2400 (10 ms)
Supply (& monitored) voltage $U_N$	V AC	3 x 230/400
Operating range		$(0.8...1.15)U_N$
Frequency	Hz	50/60
Power consumption	W/VA	$\leq 1/7.5$
Display		Matrix - LCD
Max. totalising count/Min. increment	kWh	999 999.9/0.1
LED pulses per kWh		1000
LED pulse length	ms	4±0.5

**Output specification (S0+/S0-)**

Number/Type	2 opto-isolated outputs	
Voltage range/Maximum current (conforming to EN 62053-1)	VDC/mA	3.3...27/1...27
Pulse per kWh	Imp/kWh	500
Pulse length	ms	32 ± 2
Maximum cable length	m	1000

**Technical data**

Accuracy class IEC EN 50470-3 / IEC EN 62053-23	B/2
Ambient temperature (Within accuracy class) °C	-25...+70
Protective class	II
Protection category: Housing/terminals	IP 50/IP 20

**Approvals (according to type)**



**Three-phase multi-function Bi-directional energy meters with NFC technology and backlit Matrix LCD display. MID certified for 3 or 4 wire system and single phase application up to 80 A @ 70°C.**

**Type 7M.38.8.400.0212 (with NFC)**  
**Direct connection up to 80 A, dual tariff**  
**Multi-function energy meter with RS485**  
**Modbus integrated interface and and S0**  
**output**  
**NFC technology allows to program and customize the counters via smartphone and also reading the measured energy even in the absence of mains voltage**

- Display of total or partial (resettable) consumption: kWh, kVAh, kvarh
- 2 active energy MID counters + 2 reactive energy nationally certified counters
- 16 resettable counters
- Scroll to view the following instantaneous values: V, A, PF, kW, kVA, kvar, Hz, THD V, THD A, phase angle and direction of power flow
- RS485 Modbus integrated communications port
- S0 pulse outputs for remote energy monitoring according to EN 62053-31
- Matrix backlit LCD display
- Multi-function touch button
- Active energy accuracy Class B according to EN 50470-3 (MID)
- Reactive energy accuracy Class 2 to EN 62053-23
- Sealable tamperproof terminal shield
- Protection category II
- 35 mm rail (EN 60715) mount

\* Modbus default transmission baud rate: 19 200 bps  
 For outline drawing see page 15

**NEW 7M.38.8.400.0212**



- Reference current 5 A (80 A Maximum)
- RS485 Modbus integrated interface and IR communication port and NFC technology
- 3-phase 230/400 V 50/60 Hz system: 3L+N, 3L, 1L+N
- MID certified up to 70°C

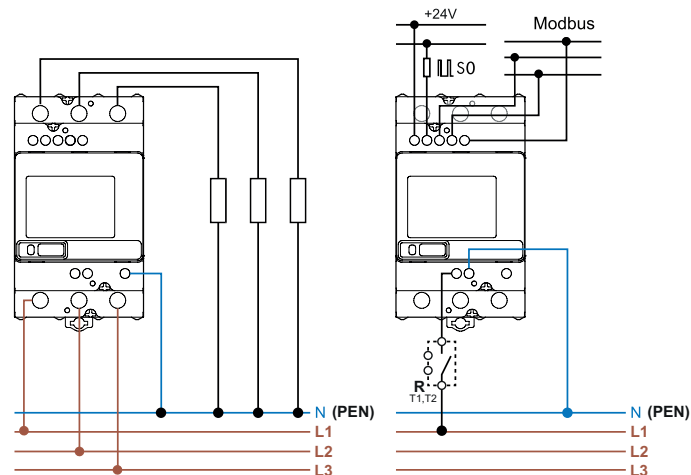

**Specification**

Reference/Maximum current $I_n/I_{max}$	A	5/80
Starting current $I_{st}$	A	0.02
Minimum measured current $I_{min}$	A	0.25
Current range (within accuracy class)	A	0.5...80
Maximum peak current	A	2400 (10 ms)
Supply (& monitored) voltage $U_N$	V AC	3 x 230/400
Operating range		$(0.8...1.15)U_N$
Frequency	Hz	50/60
Power consumption per phase	W/VA	$\leq 1/7.5$
Display		Matrix - LCD
Max. totalising count/Min. increment	kWh	999 999.9/0.1
LED pulses per kWh		1000
LED pulse length	ms	4±0.5

**Output specification (S0+/S0-)**

Number/Type		1 opto-isolated output
Voltage range/Maximum current (conforming to EN 62053-1)	VDC/mA	3.3...27/1...27
Pulse per kWh	Imp/kWh	500
Pulse length	ms	32 ± 2
Maximum cable length	m	1000

**Modbus technical data**

Bus System		Modbus RS485
Frame (default)		8, N, 2
Max bus length	m	1000
Max. Modbus energy meters connectable		32
Baud rate*	Baud	1200...115 200

**Technical data**

Accuracy class IEC EN 50470-3 / IEC EN 62053-23		B/2
Ambient temperature (Within accuracy class)	°C	-25...+70
Protective class		II
Protection category: Housing/terminals		IP 50/IP 20

**Approvals** (according to type)



**Three-phase multi-function Bi-directional energy meters with NFC technology and backlit Matrix LCD display. MID certified for 3 or 4 wire system and single phase application up to 80 A @ 70°C.**

**Type 7M.38.8.400.0312 (with NFC)**  
**Direct connection up to 80 A, dual tariff, Multi-function energy meter with M-Bus integrated interface and S0 output**  
**NFC technology allows to program and customize the counters via smartphone and also reading the measured energy even in the absence of mains voltage**

- Display of total or partial (resettable) consumption: kWh, kVAh, kvarh
- 2 active energy MID counters + 2 reactive energy nationally certified counters
- 16 resettable counters
- Scroll to view the following instantaneous values: V, A, PF, kW, kVA, kvar, Hz, THD V, THD A, phase angle and direction of power flow
- M-Bus integrated communications port
- S0 pulse outputs for remote energy monitoring according to EN 62053-31
- Matrix backlit LCD display
- Multi-function touch button
- Active energy accuracy Class B according to EN 50470-3 (MID)
- Reactive energy accuracy Class 2 to EN 62053-23
- Sealable tamperproof terminal shield
- Protection category II
- 35 mm rail (EN 60715) mount

\* M-Bus default transmission baud rate: 2400 bps

For outline drawing see page 15

**NEW 7M.38.8.400.0312**



- Reference current 5 A (80 A Maximum)
- M-Bus integrated interface and IR communication port and NFC technology
- 3-phase 230/400 V 50/60 Hz system: 3L+N, 3L, 1L+N
- MID certified up to 70°C

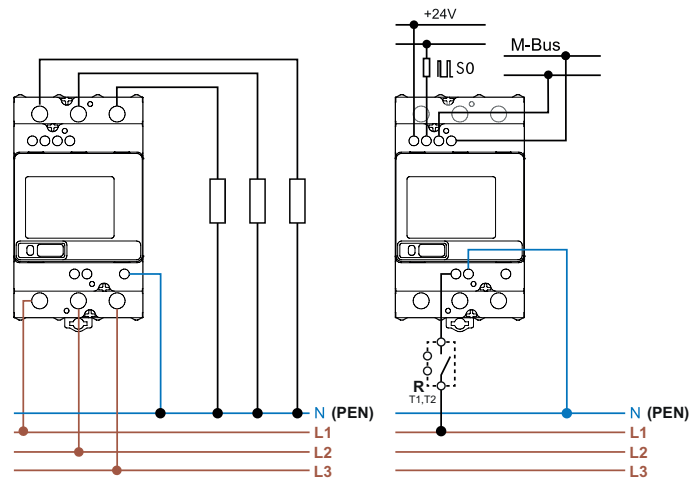

**Specification**

Reference/Maximum current $I_n/I_{max}$	A	5/80
Starting current $I_{st}$	A	0.02
Minimum measured current $I_{min}$	A	0.25
Current range (within accuracy class)	A	0.5...80
Maximum peak current	A	2400 (10 ms)
Supply (& monitored) voltage $U_N$	V AC	3 x 230/400
Operating range		$(0.8...1.15)U_N$
Frequency	Hz	50/60
Power consumption per phase	W/VVA	$\leq 1/7.5$
Display		Matrix - LCD
Max. totalising count/Min. increment	kWh	999 999.9/0.1
LED pulses per kWh		1000
LED pulse length	ms	4±0.5

**Output specification (S0+/S0-)**

Number/Type	1 opto-isolated output	
Voltage range/Maximum current (conforming to EN 62053-1)	VDC/mA	3.3...27/1...27
Pulse per kWh	Imp/kWh	500
Pulse length	ms	32 ± 2
Maximum cable length	m	1000

**M-Bus technical data**

Bus System	M-Bus	
Baud rate*	Baud	300...9600

**Technical data**

Accuracy class IEC EN 50470-3 / IEC EN 62053-23	B/2	
Ambient temperature (Within accuracy class) °C	-25...+70	
Protective class	II	
Protection category: Housing/terminals	IP 50/IP 20	

**Approvals (according to type)**



### Ordering information

Example: 1-phase energy meter for direct connection up to 40 A, S0 pulse output, Class B accuracy, for 35 mm rail (EN 60715) mounting, with integral sealable tamperproof terminal shield.

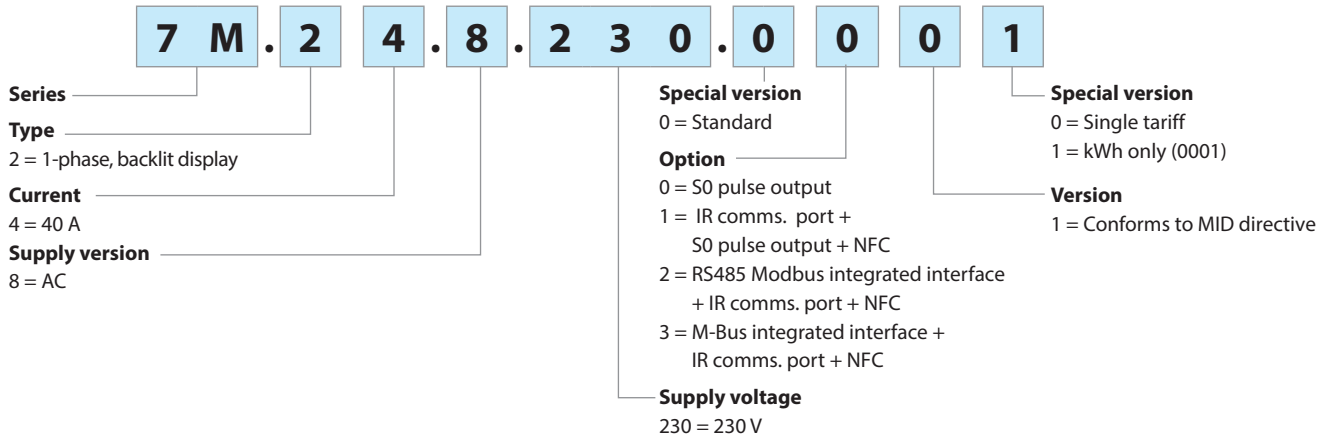

**Available versions**

- 7M.24.8.230.0001
- 7M.24.8.230.0010
- 7M.24.8.230.0110
- 7M.24.8.230.0210
- 7M.24.8.230.0310

Example: 3-phase energy meter for direct connection up to 80 A, with MID certification, Class B accuracy, for 35 mm rail (EN 60715) mounting.

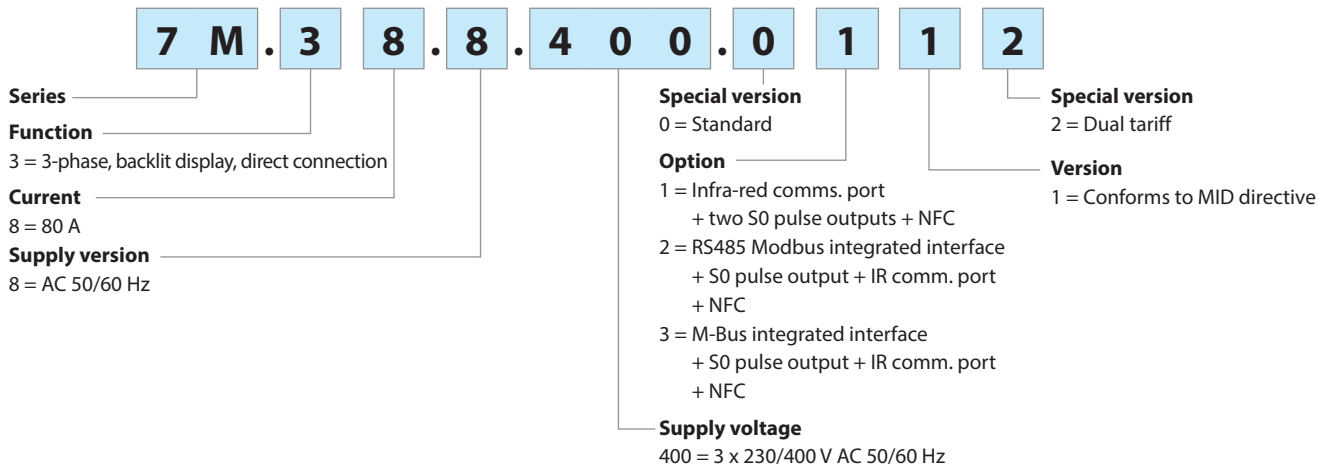

**Available versions**

- 7M.38.8.400.0112
- 7M.38.8.400.0212
- 7M.38.8.400.0312

## Technical data

Insulation		7M.24.8.230.0xxx		7M.38.8.400.0xxxx	
Insulation rated voltage		V 250		250	
Insulation	between active parts and S0+/S0- terminals	kV (1.2/50 µs)		6	
	between supply and Modbus, M-Bus terminal	kV (1.2/50 µs)		6	
	between adjacent phases	kV (1.2/50 µs)		6	
Insulation	between active parts and S0+/S0- terminals	V AC		4000	
	between supply and Modbus, M-Bus terminal	V AC		4000	
Protection class				II	
EMC Specification according to EN 61000-4-(2/3/4)		7M.24.8.230.0xxx		7M.38.8.400.0xxxx	
Electrostatic discharge	contact discharge			8 kV	
	air discharge			15 kV	
Radio frequency Electromagnetic field (80...2000)MHz				30 V/m	
Fast Transients (burst) (5-50 ns, 5 kHz)	on Supply terminals			4 kV	
	on S0+/S0- terminals			2 kV	
	Modbus, M-Bus terminal			2 kV	
Surge (1.2/50 µs)	on Supply terminals			4 kV	
Other data		7M.24.8.230.0xxx		7M.38.8.400.0xxxx	
Pollution degree				2	
Vibration resistance		EN 60068-2-6		EN 60068-2-6	
Shock resistance		EN 60068-2-27		EN 60068-2-27	
Power lost to the environment		max value per phase		0.5W/1.5 VA	
				1W/7.5VA	
Supply terminals		7M.24.8.230.0xxx		7M.38.8.400.0xxxx	
Max. wire size		solid cable	stranded cable	solid cable	stranded cable
	mm <sup>2</sup>	1.5...10	1.5...10	1.5...25	1.5...25
	AWG	16...8	16...8	16...4	16...4
Screw torque for I <sub>max</sub>		Nm	0.8	0.8	3.5
				3.5	3.5
S0+/S0- terminals, RS485 Modbus, M-Bus		7M.24.8.230.0xxx		7M.38.8.400.0xxxx	
Max. wire size		solid cable	stranded cable	solid cable	stranded cable
	mm <sup>2</sup>	0.14...2.5	0.14...2.5	0.14...2.5	0.14...2.5
	AWG	26...14	26...14	26...14	26...14
Screw torque		Nm	0.6	0.6	0.6

Wiring diagrams

Three-phase system

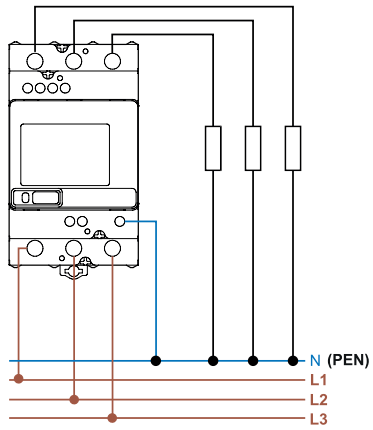

Type 7M.38.8.400.0112

Single-phase system

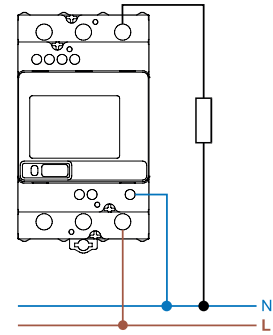

Type 7M.38.8.400.0112

Modbus or M-Bus system

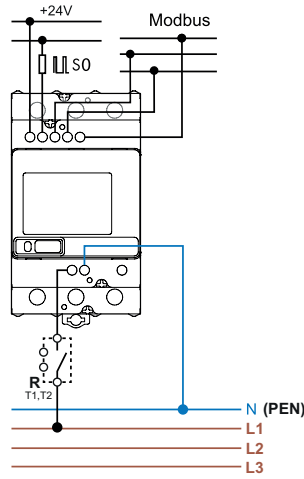

Type 7M.38.8.400.0212

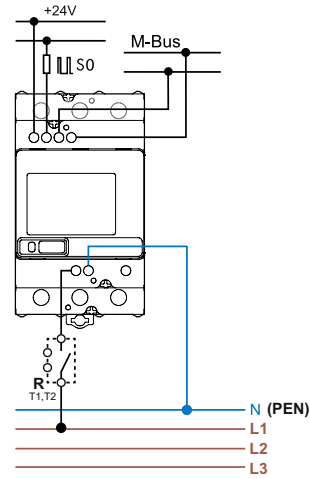

Type 7M.38.8.400.02312

E

## Two programming modes for energy meters with NFC technology

### “Smart”

Smart mode via smartphones with NFC communication using Finder toolbox NFC, iOS or Android App.



### “Classic”

Classic mode via touch button to scroll and read the meter

Android, Google Play and the Google Play logo are trademarks of Google Inc.  
Apple is a trademark of Apple Inc. App Store is a service mark of Apple Inc.

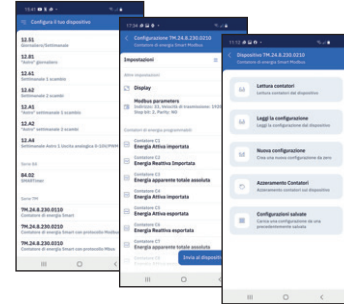

E

### Finder Toolbox NFC App for programming

Once the FINDER Toolbox NFC App is downloaded and installed, you can easily program your device thanks to NFC technology. One of the main features is that even in the absence of the power supply network, it is possible to read an energy counter, read the existing configuration, change the communication protocol parameters, or save and share the settings.

All that is required for the transfer of data is to simply touch the device with the smartphone.

### Finder Toolbox for information

Finder Toolbox can provide you with all the latest technical data sheets and news from Finder.



## Example using the NFC Toolbox APP

### Reading Counters



If you want to read all the energy counters select **“Read Counters”**



Even in the absence of the power supply network all the measurements made are readable thanks to the App - not just MID values.

E

### Modbus parameter settings

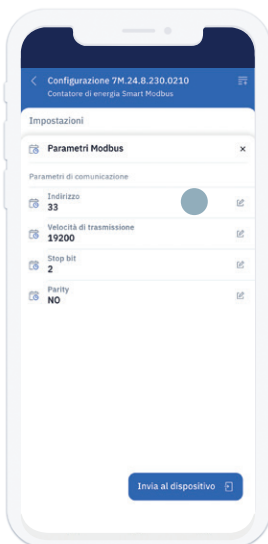

Select **“Address”** in order to change default values

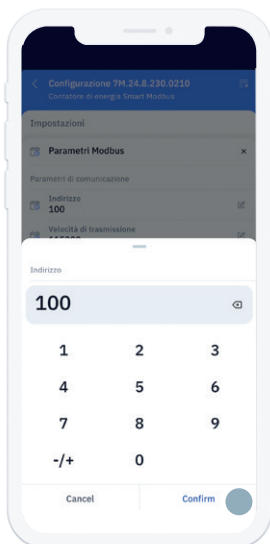

write the new address:**100**.  
Click **“Confirm”**

### Saved configuration

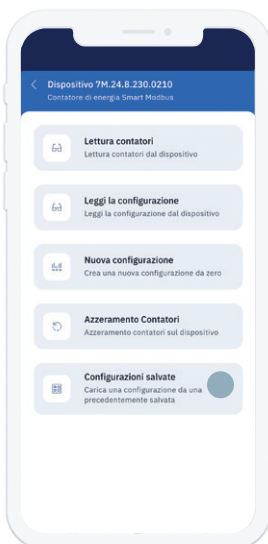

Recall the stored configuration

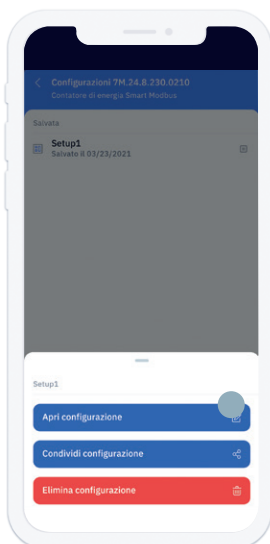

## Outline drawings

Type 7M.24.8.230.0001

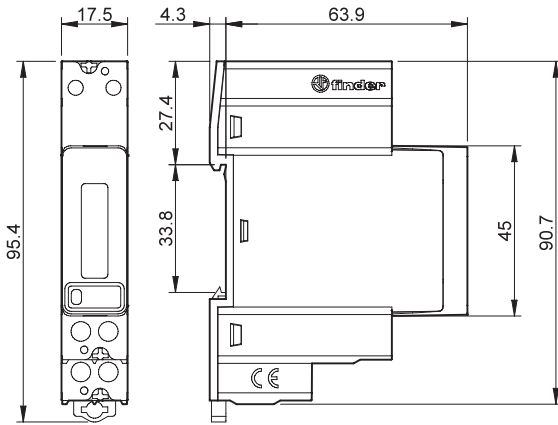

Type 7M.24.8.230.0010

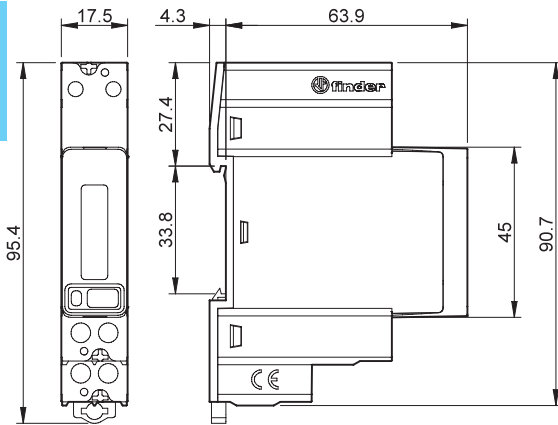

Type 7M.24.8.230.0110

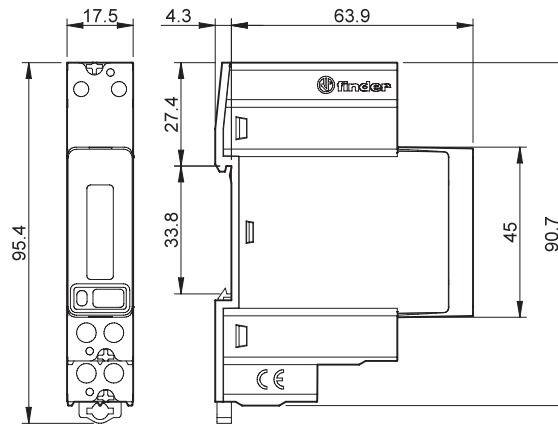

Type 7M.24.8.230.0210

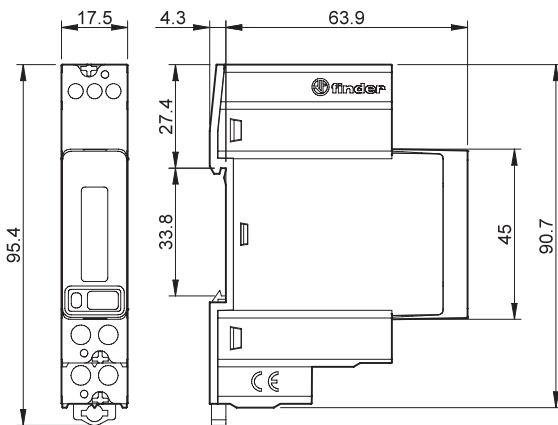

Type 7M.24.8.230.0310

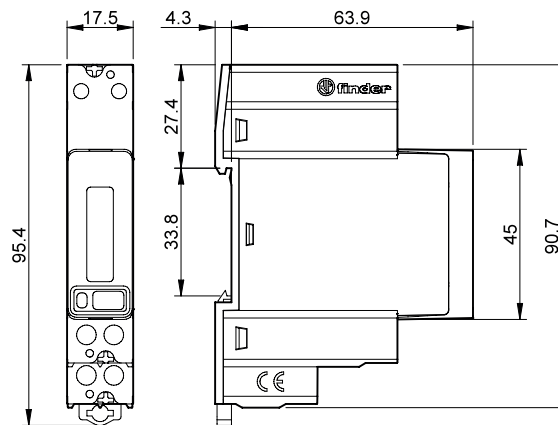

### Outline drawings

Type 7M.38.8.400.0112

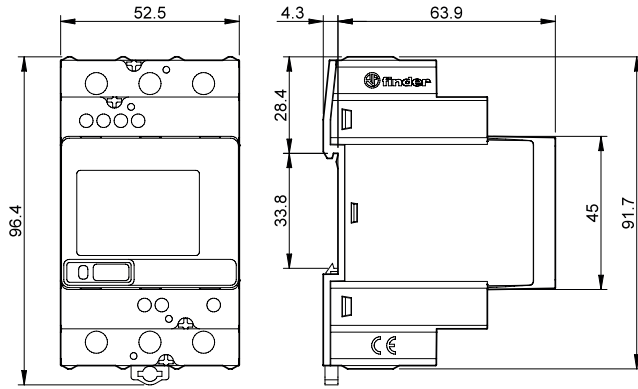

Type 7M.38.8.400.0212

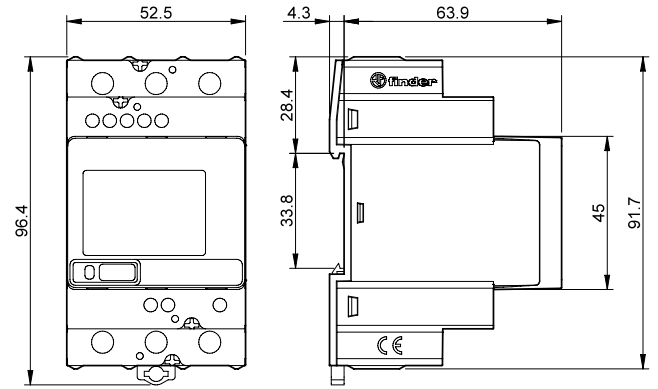

Type 7M.38.8.400.0312

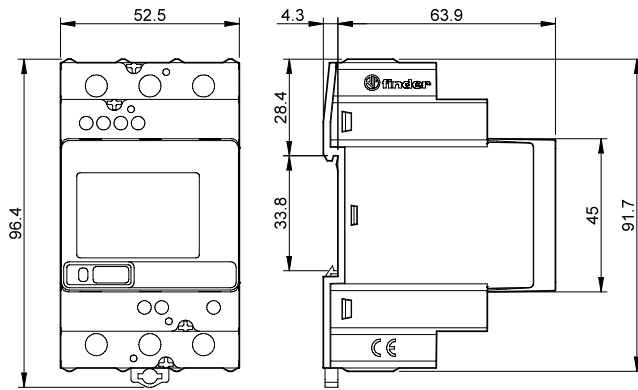

E



# Surge Protection Devices (SPD)

7P  
SERIES



Panels for electrical distribution



Control panels



Surge protection



Road / tunnel lighting



Elevators and lifts





**SPD Type 1+2 Surge arrester range high discharge capability with no following current - single/three phase systems**

- Surge arresters, suitable for low-voltage applications, to protect equipment against overvoltage by direct lightning strike, induced overvoltage and switching overvoltage
- To be installed at the boundary of LPZ 0 - LPZ 1 zones or higher
- Versions with combination of varistor and high-performance spark gap (GDT) ensures:
  - high discharge current
  - high insulation resistance that eliminates leakage current
  - no following current
- Very low residual voltage
- Replaceable modules
- Upside down mounting possible (thanks to dual terminal markings and new restraint system for the replaceable module that permits its inversion)
- Visual fault signalling: Healthy/Replace
- Double screw terminal
- Remote status signalling contact: Healthy/Replace/Presence. Connector 07P.01 included
- According to EN 61 643-11
- 35 mm rail EN 60715 mounting, 36 mm each pole

**7P.09.1.255.0100** SPD Type 1, GDT protection for N-PE application only, for 3+1 configuration

**7P.01.8.260.1025** SPD Type 1+2, varistor + GDT unipolar protection suitable to realize single phase or three phase systems (230/400V) with the GDT protection module (7P.09)

**7P.02.8.260.1025** SPD Type 1+2 for single phase TT and TN-S system. Varistor + GDT protection L-N + GDT protection N-PE

For outline drawing see page 20

**SPD specification**

		7P.09.1.255.0100		7P.01.8.260.1025		7P.02.8.260.1025	
		N-PE		L-N		N-PE	
Nominal voltage ( $U_N$ )	V AC	—		230		—	
Maximum operating voltage ( $U_C$ )	V AC	255		260		255	
Lightning impulse current (10/350 $\mu$ s) ( $I_{imp}$ )	kA	100		25		50	
Nominal discharge current (8/20 $\mu$ s) ( $I_n$ )	kA	100		30		50	
Maximum discharge current (8/20 $\mu$ s) ( $I_{max}$ )	kA	100		60		100	
Total discharge current (10/350 $\mu$ s) ( $I_{total}$ )	kA	100		25		50	
Voltage protection level ( $U_p$ )	kV	1.5		1.5		1.5	
Ability to independently switch off the following current ( $I_{if}$ )	A	100		No following current		No following current	
$I_{PE}$	$\mu$ A	< 4		< 4		< 4	
TOV 120 min L-N	V AC	—		440		—	
TOV 5 s L-N	V AC	—		335		—	
TOV 200 ms N-PE	V AC	1200		—		1200	
Response time ( $t_d$ )	ns	100		100		100	
Short-circuit proof at maximum overcurrent protection - $I_{SSCR}$	kA <sub>rms</sub>	—		50		50	
Maximum overcurrent protection (fuse rating gL/gG)	A	—		250		—	
Maximum overcurrent protection for serial connection, gL/gG	A	—		125		—	
Replacement module code		7P.00.1.000.0100		7P.00.8.260.0025		7P.00.8.260.0025 7P.00.1.000.0050	

**Other technical data**

Ambient temperature range	°C	-40...+80					
Protection degree		IP 20					
Wire size		solid cable			stranded cable		
	mm <sup>2</sup>	1 x 2.5...1 x 50			1 x 2.5...1 x 35		
	AWG	1 x 13...1 x 1			1 x 13...1 x 2		
Wire strip length	mm	11					
Screw torque	Nm	4					

**Remote status signalling contact specification**

		7P.09.1.255.0100		7P.01.8.260.1025		7P.02.8.260.1025	
		1 CO (SPDT)		1 CO (SPDT)		1 CO (SPDT)	
Rated current	A AC/DC	0.5/0.1		0.5/0.1		0.5/0.1	
Rated voltage	V AC/DC	250/30		250/30		250/30	
Wire size (07P.01)		solid cable	stranded cable	solid cable	stranded cable	solid cable	stranded cable
	mm <sup>2</sup>	1.5	1.5	1.5	1.5	1.5	1.5
	AWG	16	16	16	16	16	16

**Approvals** (according to type)

**7P.09.1.255.0100**



- SPD Type 1
- Spark gap module for N-PE application in three phase system, 3+1 configuration
- Remote contact signalling of GDT presence
- Upside down mounting possible
- Replaceable modules

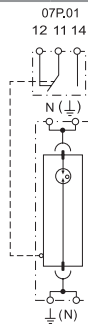

**7P.01.8.260.1025**



- SPD Type 1+2
- Combination of varistor and encapsulated spark gap (for single or three phase systems)
- Visual fault and remote contact fault signalling varistor/GDT status
- Upside down mounting possible
- Replaceable modules

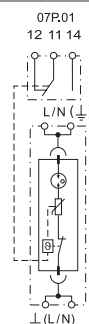

**7P.02.8.260.1025**



- SPD Type 1+2
- Combination of varistor and encapsulated spark gap (for single phase systems)
- Visual fault and remote contact fault signalling varistor/GDT status, N-PE GDT presence
- Upside down mounting possible
- Replaceable modules

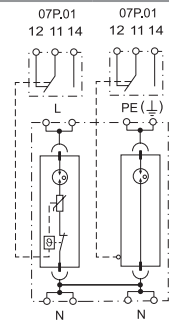

**SPD Type 1+2 Surge arrester range - three phase high discharge capability with no following current - system (230/400 V)**

- Surge arresters, suitable for low-voltage applications, to protect equipment against overvoltage by direct lightning strike, induced overvoltage and switching overvoltage
- To be installed at the boundary of LPZ 0 - LPZ 1 zones or higher
- Combined high energy varistor block and high-performance spark gap (GDT) ensures:
  - high discharge current
  - high insulation resistance that eliminates leakage current
  - no following current
- Very low residual voltage
- Replaceable modules
- Upside down mounting possible (thanks to dual terminal markings and new restraint system for the replaceable module that permits its inversion)
- Visual fault signalling: Healthy/Replace
- Double screw terminal
- Remote status signalling contact: Healthy/Replace/Presence. Connector 07P.01 included
- According to EN 61 643-11
- 35 mm rail EN 60715 mounting, 36 mm each pole

- 7P.03.8.260.1025** SPD Type 1+2 for three phase TN-C system without Neutral (PEN conductor). Varistor + GDT protection L1, L2, L3-PEN
- 7P.04.8.260.1025** SPD Type 1+2 for three phase TT and TN-S system with Neutral. Varistor + GDT protection L1, L2, L3-N + spark gap protection N-PE
- 7P.05.8.260.1025** SPD Type 1+2 for three phase TN-S system with Neutral. Varistor + GDT protection L1, L2, L3-N + varistor + GDT protection N-PE

**7P.03.8.260.1025**



- SPD Type 1+2
- 3 x combined varistor and encapsulated spark gap
- Visual fault and remote contact fault signalling varistor/GDT status
- Upside down mounting position
- Replaceable modules

**7P.04.8.260.1025**



- SPD Type 1+2
- 3 x combined varistor and encapsulated spark gap + 1 encapsulated spark gap
- Visual fault and remote contact fault signalling varistor/GDT status, N-PE GDT presence
- Upside down mounting position
- Replaceable modules

**7P.05.8.260.1025**



- SPD Type 1+2
- 4 x combined varistor and encapsulated spark gap
- Visual fault and remote contact fault signalling varistor/GDT status
- Upside down mounting position
- Replaceable modules

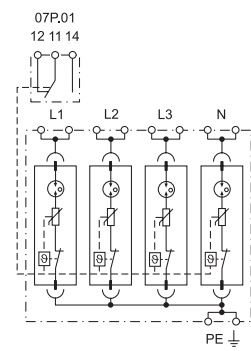
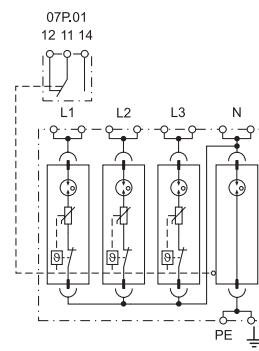
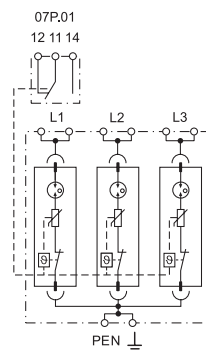

For outline drawing see page 20, 22

**SPD specification**

		L-PEN	L-N	N-PE	L, N-PE
Nominal voltage (U <sub>N</sub> )	V AC	230	230	—	230
Maximum operating voltage (U <sub>C</sub> )	V AC	260	260	255	260
Lightning impulse current (10/350 μs) (I <sub>imp</sub> )	kA	25	25	100	25
Nominal discharge current (8/20 μs) (I <sub>n</sub> )	kA	30	30	100	30
Maximum discharge current (8/20 μs) (I <sub>max</sub> )	kA	60	60	100	60
Total discharge current (10/350 μs) (I <sub>total</sub> )	kA	75	100	100	100
Voltage protection level (U <sub>p</sub> )	kV	1.5	1.5	1.5	1.5
Ability to independently switch off the following current (I <sub>f</sub> )	A	No following current	No following current	100	No following current
I <sub>PE</sub>	μA	< 4	< 4		< 4
TOV 120 min L-N	V AC	440	440	—	440
TOV 5 s L-N	V AC	335	335	—	335
TOV 200 ms N-PE	V AC	—	—	1200	—
Response time (t <sub>a</sub> )	ns	100	100	100	100
Short-circuit proof at maximum overcurrent protection - I <sub>SSCR</sub>	kA <sub>rms</sub>	50	50	—	50
Maximum overcurrent protection (fuse rating gL/gG)	A	250	250	—	250
Maximum overcurrent protection for serial connection, gL/gG	A	125	125	—	125
Replacement module code		7P.00.8.260.0025	7P.00.8.260.0025	7P.00.1.000.0100	7P.00.8.260.0025

**Other technical data**

Ambient temperature range	°C	-40...+80			
Protection degree		IP 20			
Wire size		solid cable		stranded cable	
	mm <sup>2</sup>	1 x 2.5...1 x 50		1 x 2.5...1 x 35	
	AWG	1 x 13...1 x 1		1 x 13...1 x 2	
Wire strip length	mm	11			
Screw torque	Nm	4			

**Remote status signalling contact specification**

		1 CO (SPDT)		1 CO (SPDT)		1 CO (SPDT)	
Rated current	A AC/DC	0.5/0.1		0.5/0.1		0.5/0.1	
Rated voltage	V AC/DC	250/30		250/30		250/30	
Wire size (07P.01)		solid cable	stranded cable	solid cable	stranded cable	solid cable	stranded cable
	mm <sup>2</sup>	1.5	1.5	1.5	1.5	1.5	1.5
	AWG	16	16	16	16	16	16

Approvals (according to type)





**SPD Type 1+2 Compact Surge arrester range with no leakage current for single and three phase systems (230/400 V)**

- Surge arresters, suitable for low-voltage applications, to protect equipment against overvoltage by direct lightning strike, induced overvoltage and switching overvoltage
- To be installed at the boundary of LPZ 0 - LPZ 1 zones or higher
- Combined high energy varistor block and high-performance spark gap (GDT) ensures:
  - no leakage current
  - galvanic insulation between phases
  - no following current
- Very low residual voltage
- Replaceable modules with retaining system
- Visual fault signalling: Healthy/Replace
- Double screw terminal
- Remote status signalling contact option available: Healthy/Replace/Presence
- According to EN 61643-11+A1:2018 , IEC 61643-11 Ed.2011
- 35 mm rail EN 60715 mounting, 36 mm each pole

**7P.02.8.275.1012** SPD Type 1+2 for single phase TT (TN-S) system with Neutral. Varistor + GDT protection L-N + GDT protection N-PE

**7P.04.8.275.1012** SPD Type 1+2 for three phase TT (TN-S) system with Neutral. Varistor + GDT protection L1, L2, L3-N + spark gap protection N-PE

**7P.05.8.275.1012** SPD Type 1+2 for three phase TN system. Varistor + GDT protection L1, L2, L3-PE and N-PE

**7P.02.8.275.1012**



- SPD Type 1+2
- Combination of varistor and encapsulated spark gap (for single phase systems)
- Visual fault and remote contact fault signalling varistor/GDT status, N-PE GDT presence
- Replaceable modules

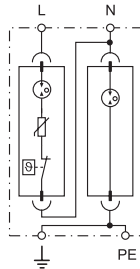

**7P.04.8.275.1012**



- SPD Type 1+2
- 3 x combined varistor and encapsulated spark gap + 1 encapsulated spark gap
- Visual fault and remote contact fault signalling varistor/GDT status
- Replaceable modules

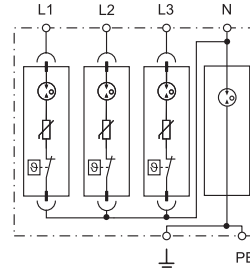

**7P.05.8.275.1012**



- SPD Type 1+2
- 4 x combined varistor and encapsulated spark gap
- Visual fault and remote contact fault signalling varistor/GDT status
- Replaceable modules

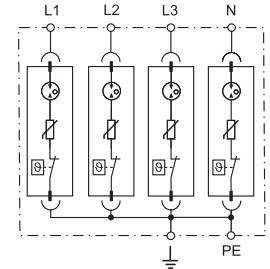

For outline drawing see page 21

**SPD specification**

		L-N	N-PE	L-N	N-PE	L-PE, N-PE
Nominal voltage (U <sub>n</sub> )	V AC	230	—	230	—	230
Maximum operating voltage (U <sub>c</sub> )	V AC	275	255	275	255	275
Lightning impulse current (10/350 μs) (I <sub>imp</sub> )	kA	12.5	25	12.5	50	12.5
Nominal discharge current (8/20 μs) (I <sub>n</sub> )	kA	30	30	30	50	30
Maximum discharge current (8/20 μs) (I <sub>max</sub> )	kA	60	60	60	100	60
Total discharge current (10/350 μs) (I <sub>total</sub> )	kA	50		50	50	50
Voltage protection level (U <sub>p</sub> )	kV	1.5	1.5	1.5	1.5	1.5
Ability to independently switch off the following current (I <sub>n</sub> )	A	No following current	100	No following current	100	No following current
I <sub>PE</sub>	μA	< 2	< 2	< 2	< 2	< 2
TOV 120 min L-N (whitstand)	V AC	440	—	440	—	440
TOV 5 s L-N (whitstand)	V AC	335	—	335	—	335
Response time (t <sub>a</sub> )	ns	100	100	100	100	100
Short-circuit proof at maximum overcurrent protection - I <sub>SSCR</sub>	kA <sub>rms</sub>	50	—	50	—	50
Maximum overcurrent protection (fuse rating gL/gG)	A	160	—	160	—	160
Replacement module code		7P.00.8.275.0012	7P.00.1.255.0025	7P.00.8.275.0012	—	7P.00.8.275.0012

**Other technical data**

Ambient temperature range	°C	-40...+80					
Protection degree alone / installed		IP 20					
Wire size		solid cable				stranded cable	
	mm <sup>2</sup>	1 x 1...1 x 35				1 x 1...1 x 25	
	AWG	1 x 17...1 x 2				1 x 17...1 x 4	
Wire strip length	mm	12					
Screw torque	Nm	3					

**Remote status signalling contact specification**

		1 CO (SPDT)		1 CO (SPDT)		1 CO (SPDT)	
Rated current	A AC/DC	0.5/0.1		0.5/0.1		0.5/0.1	
Rated voltage	V AC/DC	250/30		250/30		250/30	
Wire size (07P.01)		solid cable	stranded cable	solid cable	stranded cable	solid cable	stranded cable
	mm <sup>2</sup>	1.5	1.5	1.5	1.5	1.5	1.5
	AWG	16	16	16	16	16	16

**Approvals** (according to type)



**SPD Type 1+2 Surge arrester range with high performance "Low U<sub>p</sub>" - Single phase/three phase system**

- Surge arrester suitable for 230/400 V system applications to prevent overvoltage effects caused by direct or indirect lightning strikes
- To be installed at the boundary of LPZ 0 and LPZ 1 zones
- Very Low U<sub>p</sub> level to protect sensitive equipment
- Visual indication of varistor status - Healthy/Replace
- Contact for remote signalling of varistor status. Connector 07P.01 included
- Replaceable spark gap and modules
- Complies with EN 61 643-11
- 17.5 mm rail EN 60715 mounting for each module

**7P.12.8.275.1012** SPD Type 1+2 for single phase TT and TN-S system with Neutral.

- Varistor protection L-N + spark gap protection N-PE for single phase systems
- Replaceable spark gap and varistor modules

**7P.13.8.275.1012** SPD Type 1+2 for three phase TN-C system without Neutral (PEN conductor).

- Varistor protection L1, L2, L3-PEN for three phase systems
- Replaceable varistor modules

7P.12 / 7P.13  
Screw terminals



For outline drawing see page 22

SPD specification		L-N	N-PE	L-PEN
Nominal voltage (U <sub>N</sub> )	V AC	230	—	230
Maximum operating voltage (U <sub>C</sub> )	V AC/DC	275/—	255/—	275/—
Lightning impulse current (10/350 μs) (I <sub>imp</sub> )	kA	12.5	25	12.5
Nominal discharge current (8/20 μs) (I <sub>n</sub> )	kA	30	40	30
Maximum discharge current (8/20 μs) (I <sub>max</sub> )	kA	60	60	60
Total discharge current (10/350 μs) (I <sub>total</sub> )	kA	25	25	37.5
Voltage protection level (U <sub>p</sub> )	kV	1.5	1.5	1.5
Ability to independently switch off the following current (I <sub>n</sub> )	A	No following current	100	No following current
I <sub>PE</sub>	μA	< 1		< 2100
TOV 120 min L-N	V AC	440	—	440
TOV 5 s L-N (Withstand)	V AC	335	—	335
TOV 200 ms N-PE (Withstand)	V AC	—	1200	—
Response time (t <sub>3</sub> )	ns	25	100	25
Short-circuit proof at maximum overcurrent protection - I <sub>SSCR</sub>	kA <sub>rms</sub>	50	—	50
Maximum overcurrent protection (fuse rating gL/gG)	A	160	—	160
Replacement module code		7P.10.8.275.0012	7P.10.1.000.0025	7P.10.8.275.0012
<b>Other technical data</b>				
Ambient temperature range	°C	-40...+80		
Protection degree		IP 20		
Wire size		solid cable		stranded cable
	mm <sup>2</sup>	1 x 1...1 x 35		1 x 1...1 x 25
	AWG	1 x 17...1 x 2		1 x 17...1 x 4
Wire strip length	mm	12		
Screw torque	Nm	3		
<b>Remote status signalling contact specification</b>				
Contact configuration		1 CO (SPDT)	—	1 CO (SPDT)
Rated current	A AC/DC	0.5/0.1	—	0.5/0.1
Rated voltage	V AC/DC	250/30	—	250/30
Wire size (07P.01)		solid cable		stranded cable
	mm <sup>2</sup>	1.5	1.5	1.5
	AWG	16	16	16
<b>Approvals (according to type)</b>				

**7P.12.8.275.1012**



- SPD Type 1+2
- Replaceable spark gap and varistor modules (for single phase systems)
- Visual and remote signalling of varistor status

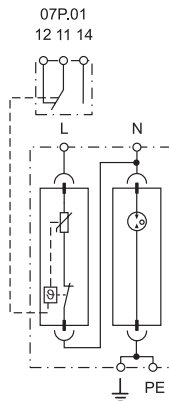

**7P.13.8.275.1012**



- SPD Type 1+2
- Replaceable varistor modules (for three phase systems)
- Visual and remote signalling of varistor status

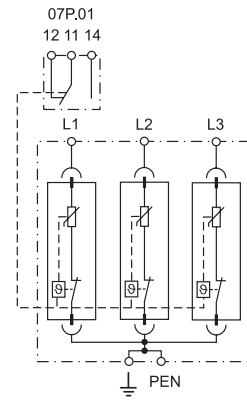

**SPD Type 1+2 Surge arrester range with high performance "Low U<sub>p</sub>" - three phase system**

- Surge arrester suitable for 230/400 V system applications to prevent overvoltage effects caused by direct or indirect lightning strikes
- To be installed at the boundary of LPZ 0 and LPZ 1 zones
- Very Low U<sub>p</sub> level to protect sensitive equipment
- Visual indication of varistor status - Healthy/Replace
- Contact for remote signalling of varistor status. Connector 07P.01 included
- Replaceable varistor modules
- Complies with EN 61 643-11
- 17.5 mm rail EN 60715 mounting for each module

**7P.14.8.275.1012** SPD Type 1+2 for three phase TT and TN-S system with Neutral.

- Varistor protection L1, L2, L3-N + spark gap protection N-PE
- Replaceable varistor modules
- Non replaceable high discharge current spark gap

**7P.15.8.275.1012** SPD Type 1+2 for three phase TN-S system with Neutral.

- Varistor protection L1, L2, L3,N-PE
- Replaceable varistor modules

7P.14 / 7P.15

Screw terminals



For outline drawing see page 22

**SPD specification**

		L-N	N-PE	L, N-PE
Nominal voltage (U <sub>N</sub> )	V AC	230	—	230
Maximum operating voltage (U <sub>C</sub> )	V AC/DC	275/—	255/—	275/—
Lightning impulse current (10/350 μs) (I <sub>imp</sub> )	kA	12.5	50	12.5
Nominal discharge current (8/20 μs) (I <sub>n</sub> )	kA	30	50	30
Maximum discharge current (8/20 μs) (I <sub>max</sub> )	kA	60	100	60
Total discharge current (10/350 μs) (I <sub>total</sub> )	kA	50	50	50
Voltage protection level (U <sub>p</sub> )	kV	1.5	1.5	1.5
Ability to independently switch off the following current (I <sub>n</sub> )	A	No following current	100	No following current
I <sub>PE</sub>	μA	< 2		< 2800
TOV 120 min L-N	V AC	440	—	440
TOV 5 s L-N (Withstand)	V AC	335	—	335
TOV 200 ms N-PE (Withstand)	V AC	—	1200	—
Response time (t <sub>a</sub> )	ns	25	100	25
Short-circuit proof at maximum overcurrent protection - I <sub>SSCR</sub>	kA <sub>rms</sub>	50	—	50
Maximum overcurrent protection (fuse rating gL/gG)	A	160	—	160
Replacement module code		7P.10.8.275.0012	—	7P.10.8.275.0012

**Other technical data**

Ambient temperature range	°C	-40...+80		
Protection degree		IP 20		
Wire size		solid cable		stranded cable
	mm <sup>2</sup>	1 x 1...1 x 35		1 x 1...1 x 25
	AWG	1 x 17...1 x 2		1 x 17...1 x 4
Wire strip length	mm	12		
Screw torque	Nm	3		

**Remote status signalling contact specification**

		1 CO (SPDT)	—	1 CO (SPDT)
Rated current	A AC/DC	0.5/0.1	—	0.5/0.1
Rated voltage	V AC/DC	250/30	—	250/30
Wire size (07P.01)		solid cable	stranded cable	solid cable
	mm <sup>2</sup>	1.5	1.5	1.5
	AWG	16	16	16

**Approvals** (according to type)



**7P.14.8.275.1012**



- SPD Type 1+2
- Replaceable varistor module
- Visual and remote signalling of varistor status

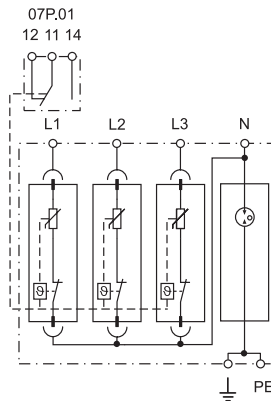

**7P.15.8.275.1012**



- SPD Type 1+2
- Replaceable varistor module
- Visual and remote signalling of varistor status

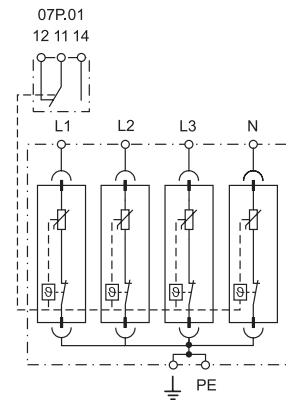

**SPD Type 2 Surge arrester range for single/ three phase AC systems and for DC systems**

- Surge arrester suitable for AC and DC systems to protect equipment against induced overvoltage or switching transients
- To be installed at the boundary of LPZ 1 - LPZ 2 zones or higher
- Visual indication of varistor status - Healthy/Replace
- Contact for remote signalling of varistor status. Connector (07P.01) included (depending on the version)
- Replaceable varistor and spark gap modules
- Complies with EN 61643-11:2012
- 17.5 mm rail EN 60715 mounting for each module

**7P.21.8.075.1015** SPD Type 2, unipolar protection suitable for DC applications or low voltage AC single phase systems

- Varistor protection +/- or L/N (GND); -/+ or GND (L/N)
- Replaceable module

**7P.21.8.130.1015** SPD Type 2, unipolar protection suitable for DC application or low voltage AC single phase systems

- Varistor protection +/- or L/N (GND); -/+ or GND (L/N)
- Replaceable module

**7P.21.8.275.x020** SPD Type 2, unipolar protection suitable to realize single phase or three phase systems (230/400 V)

- Varistor protection L/N(GND)-GND/(L/N)
- Replaceable module

**7P.21.8.440.x020** SPD Type 2, unipolar protection suitable for three phase systems (400 V AC)

- Varistor protection L/N(GND)-GND/(L/N)
- Replaceable module

**7P.22.8.275.x020** SPD Type 2 for single phase TT and TN-S system with Neutral

- Varistor protection L-N + spark gap protection N-PE
- Replaceable varistor and spark gap modules

**7P.27.8.275.x020** SPD Type 2 for single phase TN system with Neutral

- Varistor protection L, N-PE
- Replaceable varistor modules

For outline drawing see page 22

SPD specification	075.1015	130.1015	275.1020	440.1020	L-N	N-PE	L, N-PE
Nominal voltage (U <sub>N</sub> )	V AC/DC 60/60	110/125	230/—	400/—	230/—	—	230/—
Maximum operating voltage (U <sub>C</sub> )	V AC/DC 75/100	130/170	275/350	440/585	275/—	255/—	275/—
Nominal discharge current (8/20 μs) (I <sub>n</sub> )	kA 15	15	20	20	20	20	20
Maximum discharge current (8/20 μs) (I <sub>max</sub> )	kA 40	40	40	40	40	40	40
Voltage protection level at 5 kA (U <sub>p5</sub> )	kV 0.3	0.45	0.9	1.5	0.9	—	0.9
Voltage protection level at I <sub>n</sub> (U <sub>p</sub> )	kV 0.4	0.7	1.35	1.9	1.35	1.5	1.35
I <sub>PE</sub>	μA < 350	< 350	< 200	< 350	< 4		< 400
TOV 120 min L-N	V AC 115	225	440	—	440	—	440
TOV 5 s L-N	V AC 90	175	335	580	335	—	335
TOV 200 ms N-PE	V AC —	—	—	—	—	1200	—
Response time (t <sub>a</sub> )	ns —	25		—	25	100	25
Short-circuit proof at maximum overcurrent protection - I <sub>SSCR</sub>	kA <sub>rms</sub> —	50		25	50	—	50
Maximum overcurrent protection (fuse rating gL/gG)	A —	160		125	160	—	160
Replacement module code	*	**	***	****	7P.20.8.275.0020	7P.20.1.000.0020	7P.20.8.275.0020
<b>Other technical data</b>							
Ambient temperature range	°C —	-40...+80					
Protection degree	—	IP 20					
Wire size	—	solid cable			stranded cable		
mm <sup>2</sup>	—	1 x 1...1 x 35			1 x 1...1 x 25		
AWG	—	1 x 17...1 x 2			1 x 17...1 x 4		
Wire strip length	mm —	12					
Screw torque	Nm —	3					
<b>Remote status signalling contact specification</b>							
Contact configuration	—	1 CO (SPDT)			1 CO (SPDT)		
Rated current	A AC/DC —	0.5/0.1			0.5/0.1		
Rated voltage	V AC/DC —	250/30			250/30		
Wire size (07P.01)	—	solid cable	stranded cable		solid cable	stranded cable	
mm <sup>2</sup>	—	1.5	1.5		1.5	1.5	
AWG	—	16	16		16	16	

Approvals (according to type)



**7P.21.8.xxx.x0xx**



- SPD Type 2 (1 varistor)
- Replaceable varistor module
- Visual and optional remote connector for signalling of the varistor status

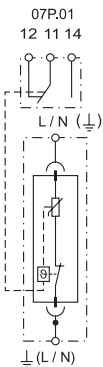

\* 7P.20.8.075.0015  
\*\* 7P.20.8.130.0015  
\*\*\* 7P.20.8.275.0020  
\*\*\*\* 7P.20.8.440.0020

**7P.22.8.275.x020**



- SPD Type 2 (1 varistor + 1 spark-gap)
- Combination of replaceable varistor and encapsulated spark gap modules
- Visual and optional remote connector for signalling of the varistor status

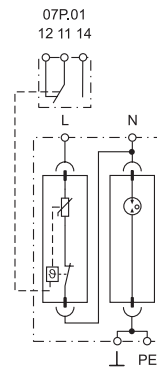

**7P.27.8.275.x020**



- SPD Type 2 (2 varistors)
- Replaceable varistor modules
- Visual and optional remote connector for signalling of the varistor status

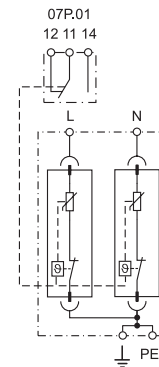

**SPD Type 2 Surge arrester range - three phase systems**

- Surge arrester suitable for 230/400 V system applications to protect equipments against induced overvoltage or switching transients
- To be installed at the boundary of LPZ 1 - LPZ 2 zones or higher
- Visual indication of varistor status - Healthy/Replace
- Contact for remote signalling of varistor status. Connector (07P.01) included (depending on the version)
- Replaceable varistor and spark gap modules
- Complies with EN 61643-11:2012
- 35 mm rail (EN 60715) mounting

**7P.23.8.275.x020** SPD Type 2 for three phase TN-C system with Neutral (PEN conductor).

- Varistor protection L1, L2, L3-PEN
- Replaceable varistor module

**7P.24.8.275.x020** SPD Type 2 for three phase TT and TN-S system with Neutral.

- Varistor protection L1, L2, L3 + spark gap protection N-PE
- Replaceable varistor and spark gap modules

**7P.25.8.275.x020** SPD Type 2 for three phase TN-S system with Neutral.

- Varistor protection L1, L2, L3, N-PE
- Replaceable varistor module

7P.23.8 / 7P.24 / 7P.25

Screw terminals



For outline drawing see page 23

**SPD specification**

	L - PEN	L-N	N-PE	L, N-PE
Nominal voltage (U <sub>N</sub> )	230	230	—	230
Maximum operating voltage (U <sub>C</sub> )	275/350	275/—	255/—	275/350
Nominal discharge current (8/20 μs) (I <sub>n</sub> )	20	20	20	20
Maximum discharge current (8/20 μs) (I <sub>max</sub> )	40	40	40	40
Voltage protection level at 5 kA (U <sub>p5</sub> )	0.9	0.9	—	0.9
Voltage protection level at I <sub>n</sub> (U <sub>p</sub> )	1.35	1.35	1.5	1.35
I <sub>PE</sub>	< 600	< 4		< 800
TOV 120 min L-N	440	440	—	440
TOV 5 s L-N	335	335	—	—
TOV 200 ms N-PE	—	—	1200	—
Response time (t <sub>a</sub> )	25	25	100	25
Short-circuit proof at maximum overcurrent protection - I <sub>SSCR</sub>	50	50	—	50
Maximum overcurrent protection (fuse rating gL/gG)	160	160	—	160
Replacement module code	7P.20.8.275.0020	7P.20.8.275.0020	7P.20.1.000.0020	7P.20.8.275.0020

**Other technical data**

Ambient temperature range	-40...+80			
Protection degree	IP 20			
Wire size	solid cable		stranded cable	
	mm <sup>2</sup>	1 x 1...1 x 35	1 x 1...1 x 25	
	AWG	1 x 17...1 x 2	1 x 17...1 x 4	
Wire strip length	12			
Screw torque	3			

**Remote status signalling contact specification**

	1 CO (SPDT)		1 CO (SPDT)		1 CO (SPDT)	
Contact configuration	1 CO (SPDT)		1 CO (SPDT)		1 CO (SPDT)	
Rated current	0.5/0.1		0.5/0.1		0.5/0.1	
Rated voltage	250/30		250/30		250/30	
Wire size (07P.01)	solid cable	stranded cable	solid cable	stranded cable	solid cable	stranded cable
	mm <sup>2</sup>	1.5	1.5	1.5	1.5	1.5
	AWG	16	16	16	16	16

**Approvals** (according to type)



**7P.23.8.275.x020**



- SPD Type 2 (3 varistors)
- Replaceable varistor module, 3 pole
- Visual and remote signalling of varistor status

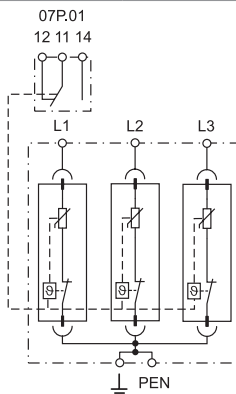

**7P.24.8.275.x020**



- SPD Type 2 (3 varistors + 1 spark-gap)
- Combination of replaceable varistor and encapsulated spark gap modules
- Visual and optional remote connector for signalling of the varistor status

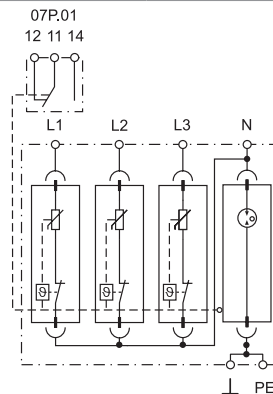

**7P.25.8.275.x020**



- SPD Type 2 (4 varistors)
- Replaceable varistor module, 4 pole
- Visual and optional remote connector for signalling of the varistor status

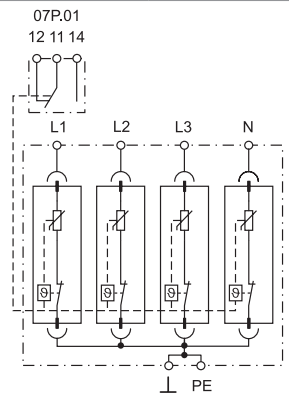



**SPD Type 2 Surge arrester range for single/ three phase AC systems without leakage current**

- Surge arrester suitable for AC systems to protect equipment against induced overvoltage or switching transients
- To be installed at the boundary of LPZ 1 - LPZ 2 zones or higher
- Versions with combination of varistor and high-performance spark gap (GDT) ensures:
  - high discharge current
  - high insulation resistance that eliminates leakage current
  - no following current
- Very low residual voltage
- Visual fault signalling: Healthy/Replace
- Remote status signalling contact: Healthy/Replace
- Connector 07P.01 included
- Replaceable modules
- Complies with EN 61643-11:2012
- 17.5 mm rail EN 60715 mounting for each module

**7P.42.8.275.1020** SPD Type 2 for single phase TT and TN-S system. Varistor + GDT protection L-N + GDT protection N-PE

**7P.43.8.275.1020** SPD Type for three phase TN-C system without Neutral (PEN conductor). Varistor + GDT protection L1, L2, L3-PEN

7P.42/7P.43

Screw terminals



For outline drawing see page 22, 23

**SPD specification**

		L-N	N-PE	L-PEN
Nominal voltage ( $U_N$ )	V AC	230	—	230
Maximum operating voltage ( $U_C$ )	V AC	275	255	275
Nominal discharge current (8/20 $\mu$ s) ( $I_n$ )	kA	20	20	20
Maximum discharge current (8/20 $\mu$ s) ( $I_{max}$ )	kA	25	40	25
Voltage protection level ( $U_p$ )	kV	1.2	1.5	1.2
Ability to independently switch off the following current ( $I_n$ )	A	No following current	100	No following current
$I_{PE}$	$\mu$ A	< 4		< 4
TOV 120 min L-N	V AC	440	—	440
TOV 5 s L-N	V AC	335	—	335
TOV 200 ms N-PE	V AC	—	1200	—
Response time ( $t_a$ )	ns	100	100	100
Short-circuit proof at maximum overcurrent protection - $I_{SSCR}$	kA <sub>rms</sub>	35	—	35
Maximum overcurrent protection (fuse rating gL/gG)	A	125	—	125
Replacement module code		7P.40.8.275.0020	7P.40.1.000.0020	7P.40.8.275.0020

**Other technical data**

Ambient temperature range	°C	-40...+80		
Protection degree		IP 20		
Wire size		solid cable		stranded cable
	mm <sup>2</sup>	1 x 1...1 x 35		1 x 1...1 x 25
	AWG	1 x 17...1 x 2		1 x 17...1 x 4
Wire strip length	mm	12		
Screw torque	Nm	3		

**Remote status signalling contact specification**

Contact configuration		1 CO (SPDT)	—	1 CO (SPDT)
Rated current	A AC/DC	0.5/0.1	—	0.5/0.1
Rated voltage	V AC/DC	250/30	—	250/30
Wire size (07P.01)		solid cable	stranded cable	solid cable
	mm <sup>2</sup>	1.5	1.5	1.5
	AWG	16	16	16

**Approvals** (according to type)



**7P.42.8.275.1020**



- SPD Type 2
- Combination of varistor and encapsulated spark gap (for single phase systems)
- Replaceable modules
- Visual fault and remote contact fault signalling varistor/GDT status

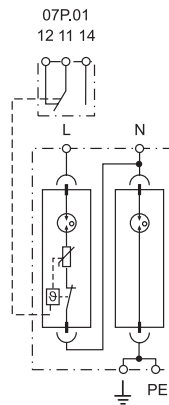

**7P.43.8.275.1020**



- SPD Type 2
- 3 x combined varistor and encapsulated spark gap
- Replaceable modules
- Visual fault and remote contact fault signalling varistor/GDT status

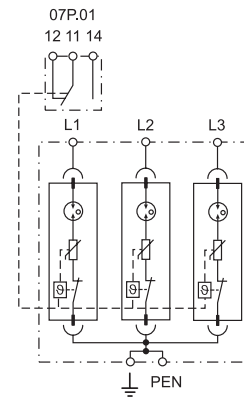

**SPD Type 2 Surge arrester range for three phase AC systems (230/400 V) without leakage current**

- Surge arrester suitable for AC systems to protect equipment against induced overvoltage or switching transients
- To be installed at the boundary of LPZ 1 - LPZ 2 zones or higher
- Versions with combination of varistor and high-performance spark gap (GDT) ensures:
  - high discharge current
  - high insulation resistance that eliminates leakage current
  - no following current
- Very low residual voltage
- Visual fault signalling: Healthy/Replace
- Remote status signalling contact: Healthy/Replace. Connector 07P.01 included
- Replaceable modules
- Complies with EN 61643-11:2012
- 17.5 mm rail EN 60715 mounting for each module

**7P.44.8.275.1020** SPD Type 2 for three phase TT and TN-S system with Neutral. Varistor + GDT protection L1, L2, L3-N + spark gap protection N-PE

**7P.45.8.275.1020** SPD Type 2 for three phase TN-S system with Neutral. Varistor + GDT protection L1, L2, L3-N + varistor + GDT protection N-PE

7P.44/7P.45  
Screw terminals



For outline drawing see page 23

SPD specification		L-N	N-PE	L, N-PE	
Nominal voltage (U <sub>N</sub> )	V AC	230	—	230	
Maximum operating voltage (U <sub>C</sub> )	V AC	275	255	275	
Nominal discharge current (8/20 μs) (I <sub>n</sub> )	kA	20	20	20	
Maximum discharge current (8/20 μs) (I <sub>max</sub> )	kA	25	40	25	
Voltage protection level (U <sub>p</sub> )	kV	1.2	1.5	1.2	
Ability to independently switch off the following current (I <sub>f</sub> )	A	No following current	100	No following current	
I <sub>PE</sub>	μA	< 4		< 4	
TOV 120 min L-N	V AC	440	—	440	
TOV 5 s L-N	V AC	335	—	335	
TOV 200 ms N-PE	V AC	—	1200	—	
Response time (t <sub>a</sub> )	ns	100	100	100	
Short-circuit proof at maximum overcurrent protection - I <sub>SSCR</sub>	kA <sub>rms</sub>	35	—	35	
Maximum overcurrent protection (fuse rating gL/gG)	A	125 A	—	125 A	
Replacement module code		7P.40.8.275.0020	7P.40.1.000.0020	7P.40.8.275.0020	
<b>Altri dati tecnici</b>					
Ambient temperature range	°C	-40...+80			
Protection degree		IP 20			
Wire size		solid cable		stranded cable	
	mm <sup>2</sup>	1 x 1...1 x 35		1 x 1...1 x 25	
	AWG	1 x 17...1 x 2		1 x 17...1 x 4	
Wire strip length	mm	12			
Screw torque	Nm	3			
<b>Remote status signalling contact specification</b>					
Contact configuration		1 CO (SPDT)	—	1 CO (SPDT)	
Rated current	A AC/DC	0.5/0.1	—	0.5/0.1	
Rated voltage	V AC/DC	250/30	—	250/30	
Wire size (07P.01)		solid cable	stranded cable	solid cable	stranded cable
	mm <sup>2</sup>	1.5	1.5	1.15	1.5
	AWG	16	16	16	16
<b>Approvals</b> (according to type)					

**7P.44.8.275.1020**



- SPD Type 2
- 3 x combined varistor and encapsulated spark gap + 1 encapsulated spark gap
- Visual fault and remote contact fault signalling varistor/GDT status
- Replaceable modules

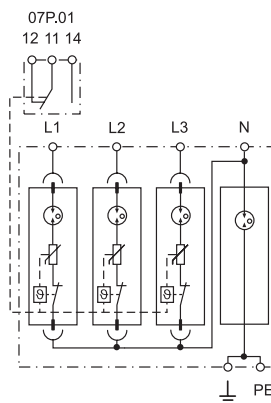

**7P.45.8.275.1020**



- SPD Type 2
- 4 x combined varistor and encapsulated spark gap
- Visual fault and remote contact fault signalling varistor/GDT status
- Replaceable modules

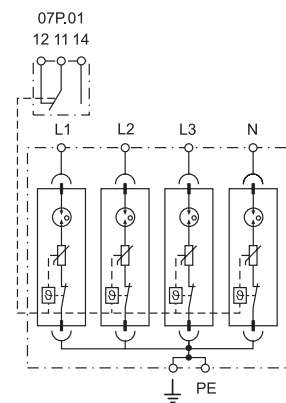

**SPD Type 2 Surge arrester range for photovoltaic applications**

- Surge arrester Type 2 for protection of DC side with  $U_{CPV}$  from 750 V up to 1500 V DC
- Protects equipment against induced overvoltage caused by lightning strikes or switching transients

**7P.23.9.750.x020**,  $U_{CPV} = 750$  V DC  
**7P.23.9.000.x015**,  $U_{CPV} = 1020$  V DC  
**7P.23.9.500.x015**,  $U_{CPV} = 1500$  V DC

- Visual indication of varistor status - Healthy/Replace
- Contact for remote signalling of varistor status. Connector (07P.01) included (depending on the version)
- Replaceable modules
- Complies with EN 61643-31, IEC 61643-21
- 35 mm rail (EN 60715) mounting

**7P.23.9.750.x020**



- SPD Type 2 (3 Y varistors) for photovoltaic systems with  $U_{CPV}$  of 750 V DC
- Replaceable varistor modules
- Visual and optional remote connector for signalling of the varistor status

**7P.23.9.000.x015**



- SPD Type 2 (3 Y varistors) for photovoltaic systems with  $U_{CPV}$  of 1020 V DC
- Replaceable varistor modules
- Visual and optional remote connector for signalling of the varistor status

**7P.23.9.500.x015**



- SPD Type 2 (3 Y varistors) for photovoltaic systems with  $U_{CPV}$  of 1500 V DC
- Replaceable varistor modules
- Visual and remote signalling of varistor status

7P.23.9  
Screw terminals

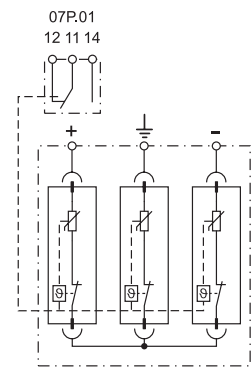
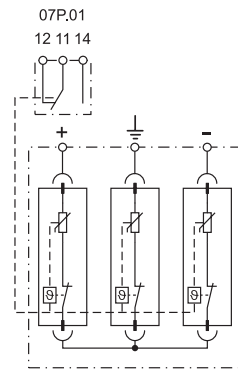
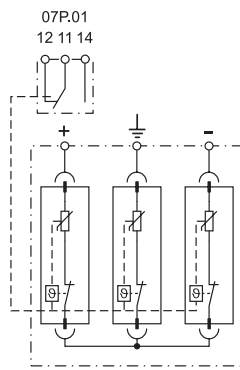

For outline drawing see page 23

SPD specification		Varistor module		Varistor module		Varistor module	
Maximum operating voltage mode +/PE and -/PE ( $U_{CPV}$ )	V DC	750	1020	1500			
Maximum operating voltage/per module ( $U_{CPV}$ )	V DC	375	510	750			
Nominal discharge current/per module (8/20 $\mu$ s) ( $I_n$ )	kA	20	15	15			
Maximum discharge current/per module (8/20 $\mu$ s) ( $I_{max}$ )	kA	40	40	40			
Total discharge current (8/20 $\mu$ s) ( $I_{Total}$ )	kA	40	40	40			
Voltage protection level/per module ( $U_p$ )	kV	1.8	2	3.2			
Voltage protection level of the system $U_p (+ \rightarrow -)/(+/- \rightarrow PE)$	kV	3.6/3.6	4/4	6.4/6.4			
Residual current (+ $\rightarrow$ -)/(+/- $\rightarrow$ PE)	$\mu$ A DC	< 5	< 5	< 5			
Residual current (+ $\rightarrow$ -)/(+/- $\rightarrow$ PE)	$\mu$ A AC	250	250	250			
Response time ( $t_a$ )	ns	25	25	25			
Short circuit current withstand $I_{SCPV}$	A	10 000	10 000	10 000			
Replacement module code		7P.20.9.375.0020	7P.20.9.500.0015	7P.20.9.750.0015			
<b>Other technical data</b>							
Fault indication		Mechanical indicator and optional remote connector					
Ambient temperature range	$^{\circ}$ C	-40...+80					
Protection degree		IP 20					
Wire size		solid cable		stranded cable			
	$mm^2$	1 x 1...1 x 35		1 x 1...1 x 25			
	AWG	1 x 17...1 x 2		1 x 17...1 x 4			
Wire strip length	mm	14					
Screw torque	Nm	3					
<b>Remote status signalling contact specification</b>							
Contact configuration		1 CO (SPDT)		1 CO (SPDT)		1 CO (SPDT)	
Rated current	A AC/DC	0.5/0.1		0.5/0.1		0.5/0.1	
Rated voltage	V AC/DC	250/30		250/30		250/30	
Wire size (07P.01)		solid cable	stranded cable	solid cable	stranded cable	solid cable	stranded cable
	$mm^2$	1.5	1.5	1.5	1.5	1.5	1.5
	AWG	16	16	16	16	16	16
<b>Approvals</b> (according to type)							



**SPD Type 1+2 Surge Arrester range for photovoltaic applications**

- Surge arrester for protection of PV systems with  $U_{CPV}$  up to 1500 V DC
- Protects equipment against overvoltage caused by direct lightning strikes and induced overvoltages
- Suitable for non-isolated LPS systems

**7P.13.9.000.x006**,  $U_{CPV} = 1050$  V DC  
**7P.13.9.500.x006**,  $U_{CPV} = 1500$  V DC

- Visual indication of varistor status - Healthy/Replace
- Contact for remote signalling of varistor status. Connector (07P.01) included
- Compact design. Can be mounted inversely
- Complies with EN 61643-31, IEC 61643-31
- 35 mm rail (EN 60715) mounting

**NEW 7P.13.9.000.x006**



- SPD Type 1+2 (3 Y varistors) for PV system with  $U_{CPV}$  1050 V DC
- Compact design. Can be mounted inversely
- Visual and optional remote connector for signalling of the varistor status

**NEW 7P.13.9.500.x006**



- SPD Type 1+2 (3 Y varistors) for PV system with  $U_{CPV}$  1500 V DC
- Compact design. Can be mounted inversely
- Visual and optional remote connector for signalling of the varistor status

7P.13  
Screw terminals



For outline drawing see page 23

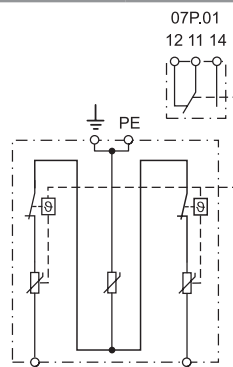

**PVT1+T2**

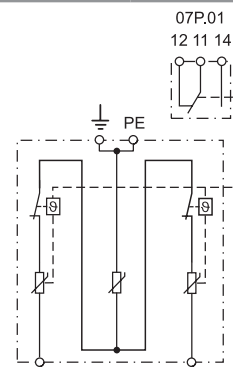

**PVT1+T2**

**SPD specification**

		<b>PVT1+T2</b>	<b>PVT1+T2</b>
Maximum operating voltage mode +/-PE, -/PE ( $U_{CPV}$ )	V DC	1050	1500
Lightning impulse current (10/350 $\mu$ s)/ per module ( $I_{mp}$ )	kA	6.25	6.25
Nominal discharge current/ per module (8/20 $\mu$ s) ( $I_n$ )	kA	20	20
Maximum discharge current/ per module (8/20 $\mu$ s) ( $I_{max}$ )	kA	40	40
Total discharge current (10/350 $\mu$ s) ( $I_{Total}$ )	kA	12.5	12.5
Total discharge current (8/20 $\mu$ s) ( $I_{Total}$ )	kA	80	80
Voltage protection level module +/- ( $U_p$ )	kV	3.8	5.4
Voltage protection level module (+PE)/(-PE) ( $U_p$ )	kV	3.8	5.4
Response time ( $t_a$ )	ns	25	25
Short circuit current rating $I_{SCPV}$	kA	20	20
Residual current mode +/-PE, -/PE ( $I_{PE}$ )	$\mu$ A AC	500	500
Residual current mode +/-PE, -/PE ( $I_{PE}$ )	$\mu$ A DC	10	10

**Other technical data**

Fault indication	Red indication flag and remote contact			
Ambient temperature range	$^{\circ}$ C	-40...+80		
Protection degree	IP 20			
Wire size		stranded cable		solid cable
	$mm^2$	1 x 2.5...1 x 25		1 x 4...1 x 35
	AWG	1 x 13...1 x 4		1 x 11...1 x 2
Wire strip length	mm	14		
Screw torque	Nm	3		

**Remote status signalling contact specification**

		<b>PVT1+T2</b>		<b>PVT1+T2</b>	
Contact configuration		1 CO (SPDT)		1 CO (SPDT)	
Rated current	A AC/DC	0.5/0.1		0.5/0.1	
Rated voltage	V AC/DC	250/30		250/30	
Wire size (07P.01)		solid cable	stranded cable	solid cable	stranded cable
	$mm^2$	1.5	1.5	1.5	1.5
	AWG	16	16	16	16

**Approvals** (according to type)



**SPD Type 3, Surge arrester for TT and TN-S system (with Neutral)**

**Single phase applications within socket outlets and 35 mm rail mounting**

- Protects electrical and electronic equipment sensitive to impulse overvoltage
- Varistor and spark gap (GDT) combination avoiding earth leakage current
- Conforms to EN 61643-11:2012

**7P.31.8.275.0005**

- Unipolar protection (L/N)
- IP 65 SPD
- LED indication of need to replace the SPD
- 2 wires, 150 mm long, for ease of connection

**7P.32.8.275.0005**

- "1+1" configuration: varistor + spark gap with very low  $U_p$  level
- IP 65 SPD
- LED indication of need to replace the SPD
- 3 wires, 150 mm long, for ease of connection

**7P.31.8.275.0005**



**7P.32.8.275.0005**



- SPD Type 3
- Unipolar protection suitable also for LED lamp protection
- IP 65

- SPD Type 3
- "1+1" configuration suitable also for LED lamp protection
- IP 65

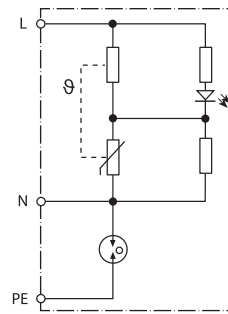
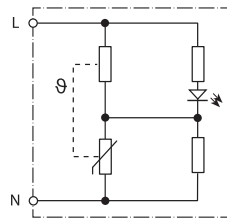

\* see diagram L7P page 29  
For outline drawing see page 24

**SPD specification**

Nominal voltage ( $U_N$ )	V AC	230	230
Maximum operating voltage ( $U_C$ )	V AC	275	275
Nominal discharge current (8/20 $\mu$ s) L-N, L(N)-PE ( $I_n$ )	kA	5/—	5/5
Maximum discharge current (8/20 $\mu$ s) L-N, N-PE ( $I_{max}$ )	kA	10/—	10/10
Test voltage of the combined generator L-N, L(N)-PE ( $U_{OC}$ )	kV	10/—	10/10
Voltage protection level L-N, L(N)-PE ( $U_p$ )	kV	1.6/—	1.65/1.5
Response time L-N, L(N)-PE ( $t_a$ )	ns	25/—	25/100
Short-circuit proof at maximum overcurrent protection - $I_{SSCR}$	$kA_{rms}$	1.5	1.5
Maximum overcurrent protection		16 A gL/gG, B16 A, C10 A	16 A gL/gG, B16 A, C10 A
<b>Other technical data</b>			
Ambient temperature range	$^{\circ}C$	-25...+80	-25...+80
Protection degree		IP 65	IP 65
<b>Approvals</b> (according to type)			

**SPD Type 3, Surge arrester for TT and TN-S system (with Neutral)**

**Single phase applications within socket outlets and 35 mm rail mounting**

- Protects electrical and electronic equipment sensitive to impulse overvoltage
- Varistor and spark gap (GDT) combination avoiding earth leakage current
- Conforms to EN 61643-11:2012

**7P.36.8.275.2003**

- Provides easy additional surge protection for 230 V sockets
- "Y" configuration: varistor + spark gap with very low  $U_p$  level
- Audible indication of need to replace varistor and jumper test point for SPD status
- 3-wires, 150 mm long, for connection to socket terminals

**7P.37.8.275.1003**

- "1+1" configuration: varistor + spark gap with very low  $U_p$  level
- Permits serial connection for optimized load protection up to 16 A
- Integral CO contact for remote signalling of varistor status - contact gold plated for reliable low level switching
- 17.5 mm L-N/N-PE protection
- Mounting on 35 mm DIN rail (EN 60715)

**7P.36.8.275.2003**



- SPD Type 3
- "Y" configuration
- Audible (buzzing) signalling of varistor fault

**7P.37.8.275.1003**



- SPD Type 3
- "1+1" configuration
- Series connection for protection of loads up to 16 A
- Remote signalling of varistor status by integral change-over relay contact

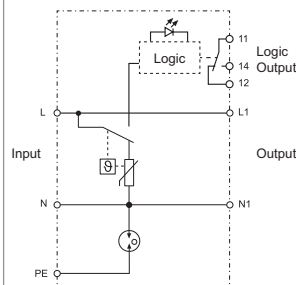
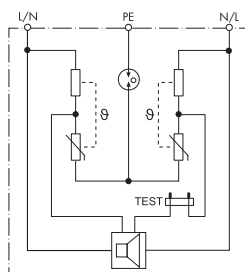

\* see diagram L7P page 29

For outline drawing see page 23, 24

**SPD specification**

Nominal voltage ( $U_N$ )	V AC	230	230
Maximum operating voltage L-N/N-PE ( $U_C$ )	V AC	275	275/255
Rated load current ( $I_L$ )	A	—	16
Nominal discharge current (8/20 $\mu$ s) L-N, L(N)-PE ( $I_n$ )	kA	3/3	3/3
Test voltage of the combined generator L-N, L(N)-PE ( $U_{OC}$ )	kV	6/6	6/6
Voltage protection level L-N, L(N)-PE ( $U_p$ )	kV	1.65/1.5	1/1.5
Response time L-N, L(N)-PE ( $t_a$ )	ns	25/100	25/100
Short-circuit proof at maximum overcurrent protection - $I_{SSCR}$	kA <sub>rms</sub>	1.5	5
Maximum overcurrent protection		16 A gL/gG, B16 A, C10 A	C16 A, 16 A gG
<b>Other technical data</b>			
Ambient temperature range	°C	-20...+70	-20...+70*
Protection degree		IP 20	IP 20
Wire size		—	solid cable   stranded cable
	mm <sup>2</sup>	—	0.5...4   0.5...4
	AWG	—	20...11   20...12
Wire strip length	mm	—	9
Screw torque	Nm	—	0.8
<b>Remote status signalling contact specification</b>			
Contact configuration		—	1 CO (SPDT)
Rated current	A AC	—	0.5
Rated voltage	V AC	—	230
Breaking capacity DC1: 24/110	A	—	2/0.3
Minimum switching load	mW (V/mA)	—	10 (5/5)
Contact material		—	AgNi + Au
<b>Approvals</b> (according to type)			

**SPD Type 2+3 with combination of coarse and fine suppression for 2 wires data lines and signalling network**

- Suitable for the protection of 2 wires data lines and telecommunication interface allowing continuity of the shield
- Permits serial connection optimizing the fine protection of longitudinal overvoltage (core-PG) and lateral overvoltage (core-core)
- Conform to EN 61643-21+A1,A2:2013, EN IEC61643-21+A1,A2:2012 C2,C3
- DIN rail mounting

**7P.62.9.009.0485**

- Suitable for the protection of RS485 data lines of inverter, PLC, energy meters or other interfaces

**7P.62.9.036.0005**

- Suitable for the protection of fire detection systems, telecommunications interfaces and 2-wire data lines

**7P.62.9.009.0485**



- SPD Type 2+3
- Protection of RS485 data lines, telecommunication and other Bus lines

**7P.62.9.036.0005**



- SPD Type 2+3
- Protection of fire detection systems, telecommunication and other data/Bus lines

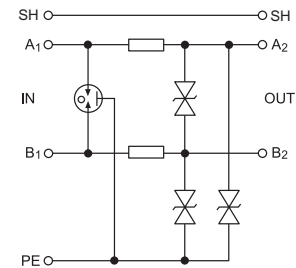
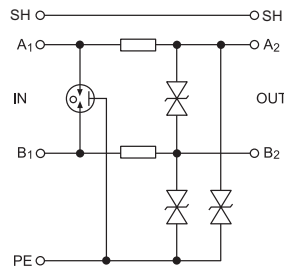

For outline drawing see page 24

**SPD specification**

Nominal voltage (U <sub>N</sub> )	V DC	6	24
Maximum operating voltage (U <sub>C</sub> )	V DC	8.5	36
Nominal load current (I <sub>L</sub> )	A	0.5	0.5
C2 nominal discharge current (8/20 μs) core-core (I <sub>n</sub> )	kA	5	5
C2 total discharge current (8/20 μs) cores-PE (C)	kA	10	10
C2 voltage protection level mode core-core @ I <sub>n</sub> (U <sub>p</sub> )	V	18	50
C2 voltage protection level mode core-PE @ I <sub>n</sub> (U <sub>p</sub> )	V	30	65
C3 voltage protection level mode core-core @ 1 kV/μs (U <sub>p</sub> )	V	12	45
C3 voltage protection level mode core-PE @ 1 kV/μs (U <sub>p</sub> )	V	15	45
Response time core-core/core-PE (t <sub>a</sub> )	ns	1/1	1
Serial resistance per core (R)	Ω	1.6	1.6
Threshold frequency core-core (f)	MHz	1	4

**Other technical data**

Range of operating temperature	°C	-40...+70			
Degree of protection		IP 20			
Wire size		solid cable	stranded cable	solid cable	stranded cable
	mm <sup>2</sup>	4	2.5	4	2.5
	AWG	12	14	12	14

**Approvals** (according to type)



**Data line SPD for Ethernet Cat. 6**

- Suitable for Ethernet, POE (Power over Ethernet) and dataline transmission system up to 250 MHz
- Protection of all pairs of conductors with minimum attenuation
- Aluminum chassis and RJ45 in metal screens
- Included accessories for simple installation near the equipment to be protected, LPZ boundary 2-3 (Type 3)
- Complies to EN 61643-21
- Mounting on 35 mm DIN rail

**7P.68.9.060.0600**



- Ethernet Cat 6 - 60 V
- Shielded RJ45 connectors

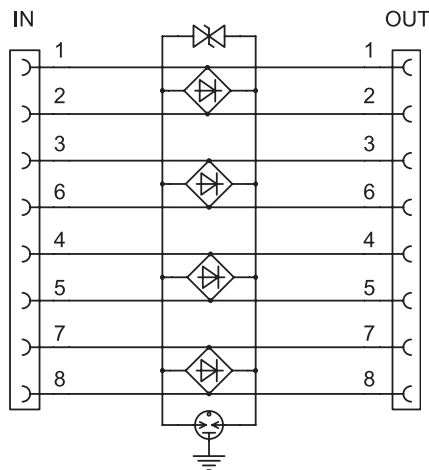

For outline drawing see page 24

**SPD specification**

Nominal voltage of system ( $U_N$ )	V DC	48
Maximum operating voltage ( $U_C$ )	V DC	60
Nominal current ( $I_L$ )	mA	500
C2 total nominal discharge current (8/20 $\mu$ s) line - PG ( $I_n$ )	kA	1.6
C2 nominal discharge current (8/20 $\mu$ s) line-line ( $I_n$ )	A	200
Voltage protection level line-line @ $I_n$ (C2) - ( $U_p$ )	V	130
Voltage protection level line-PG @ $I_n$ (C2) - ( $U_p$ )	V	350
Voltage protection level line-line @ 1 kV/ $\mu$ s (C3) - ( $U_p$ )	V	130
Insertion attenuation @ 250 MHz	dB	< 2
Response time	ns	1

**Other technical data**

Ambient temperature range	°C	-40...+80
Degree of protection		IP 20
Input-Output connection		RJ45/RJ45 shielded

**Approvals** (according to type)



## Ordering information

Example: 7P series, surge protection device, Type 2, three-phase ( $U_c = 275\text{ V}$ ), 1 varistor + 1 encapsulated spark gap, with remote status signalling contact,  $I_n = 20\text{ kA}$

**7 P . 2 4 . 8 . 2 7 5 . 1 0 2 0**

- Series**
- Type**
- 0 = Combined type 1 + 2 arresters MOV+GDT, leakage free
  - 1 = Type 1+2 high performance MOV
  - 2 = Type 2 surge arresters
  - 3 = Type 3 surge arresters
  - 4 = Type 2 surge arrester without leakage current
  - 6 = Data line SPD
- Circuit**
- 1 = Single phase (1 varistor)
  - 2 = Single phase (1 varistor + 1 spark-gap), protected poles (data line SPD)
  - 2 = Protected poles (Data line SPD)
  - 3 = Three-phase (3 varistors)
  - 4 = Three-phase (3 varistors + 1 spark-gap)
  - 5 = Three-phase (4 varistors)
  - 6 = 1 varistors + 1 spark-gap(7P.36)
  - 7 = Single phase (2 varistors) Type 2 (7P.27)
  - 7 = Single phase (1 varistor + 1 spark gap) Type 3, DIN rail mounting (7P.37)
  - 8 = Protected poles (Data line SPD)
  - 9 = N-PE spark-gap for three phase system
  - 0 = Spare module
- Supply version**
- 1 = N+PE connection (only for single spark gap replaceable module and 7P.09)
  - 8 = AC (50/60 Hz)
  - 9 = DC (PV application and Data line SPD)
- Supply voltage**
- 000 = N+PE connection for spark gap modules
  - 009 = 8.5 V DC Max ( $U_c$ ) SPD Data line SPD
  - 036 = 36 V DC Max ( $U_c$ ) SPD Data line SPD
  - 060 = 60 V DC Max ( $U_c$ ), Data line SPD
  - 075 = 75 V AC Max
  - 130 = 130 V AC Max
  - 440 = 440 V Max ( $U_c$ ) for SPD Type 2 (for  $U_N = 400\text{ V AC}$ )
  - 275 = 275 V Max for SPD Type 1+2 "Low  $U_p$ ", Type 2 ( $U_c$ ) (for  $U_N = 230\text{-}240\text{ V AC}$ ) and Type 3
  - 260 = 260 V Max ( $U_c$ ) for SPD Type 1+ 2 (for  $U_N = 230\text{-}240\text{ V AC}$ )
  - 255 = 255 V Max ( $U_c$ ) for SPD Type 1, N+PE (7P.09)
- Nominal discharge current**
- 100 = 100 kA ( $I_{imp}$  Type 1) only for 7P.09, N-PE GDT for 7P.04
  - 050 = 50 kA ( $I_{imp}$  Type 1 N-PE GDT for 7P.02)
  - 025 = 25 kA ( $I_{imp}$  Type 1+2)
  - 020 = 20 kA ( $I_n$  Type 2)
  - 015 = 15 kA ( $I_n$  Type 2)
  - 012 = 12.5 kA ( $I_{imp}$  Type 1+2)
  - 003 = 3 kA ( $I_n @ U_{oc}$  only for 7P.36 and 7P.37)
  - 005 = 5 kA ( $I_n @ U_{oc}$  for 7P.31, 7P.32 and 7P.62)
  - 006 = 6.25 kA ( $I_{imp}$  Type 1+2)
  - 007 = 7.5 kA ( $I_{imp}$  Type 1+2)
  - 107 = 7.5 kA ( $I_{imp}$  Type 1+2) with remote status signalling contact
  - 012 = 12.5 kA ( $I_{imp}$  Type 1+2)
  - 112 = 12.5 kA ( $I_{imp}$  Type 1+2) with remote status signalling contact
  - 485 = RS485 Modbus protocol (Data line SPD)
  - 600 = Ethernet Cat 6 (Data line SPD)
- Remote status signalling contact**
- 0 = Without remote status signalling contact (only some Type 2 SPD and Data line)
  - 1 = Built-in remote status signalling contact
  - 2 = Acoustic fault signalling (only for 7P.36)

### Supply voltage PV SPD

- UCPV  $\geq 1.2 U_{oc}$  STC**
- 000 = 1050 V DC UCPV SPD T1+2 (7P.13.9), 1020 V DC UCPV PV SPD T2 (7P.23.9)
  - 500 = 1500 V DC UCPV
  - 750 = 750 V DC UCPV

## Upside down mounting

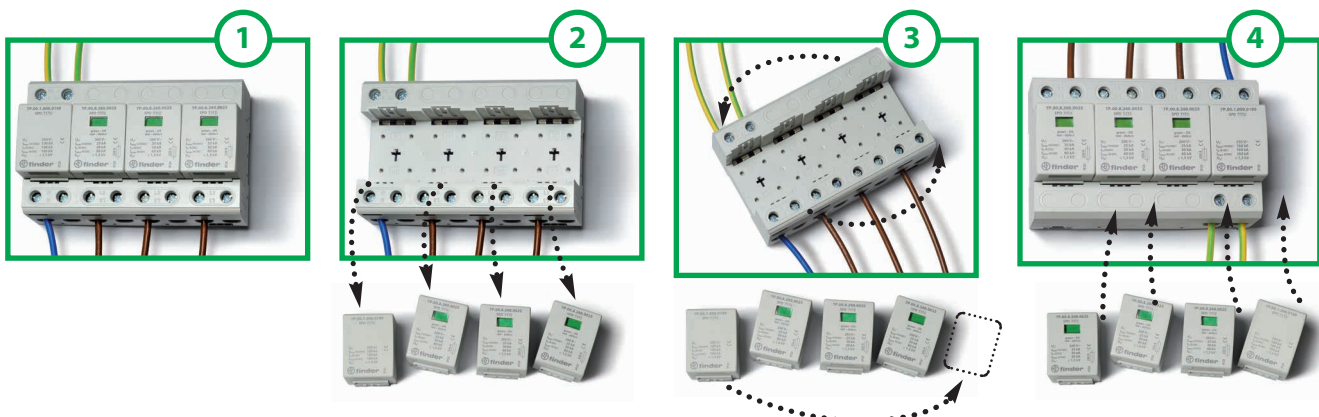

### Replaceable modules



Replacement varistor and modules		7P.00.8.260.0025	7P.00.9.500.0012	7P.00.1.000.0050	7P.00.1.000.0100
		Varistor + GDT	Varistor + GDT	Spark-Gap	Spark-Gap
Maximum operating voltage ( $U_C/U_{CPV}$ )	V AC/DC	260/—	—/500	255/—	255/—
Lightning Impulse current (10/350 $\mu$ s) ( $I_{imp}$ )	kA	25	12.5	50	100
Nominal discharge current (8/20 $\mu$ s) ( $I_n$ )	kA	30	30	50	100
Maximum discharge current (8/20 $\mu$ s) ( $I_{max}$ )	kA	60	60	100	100
Voltage protection level ( $U_p$ )	kV	1.5	1.8	1.5	1.5
Leakage current (@ 253 V AC) & $I_{pe}$ current	$\mu$ A	< 4	< 4	< 4	< 4
Response time ( $t_a$ )	ns	100	25	100	100
Maximum overcurrent protection		250 A gL/gG	—	—	—



Replacement varistor and modules		7P.00.8.275.0012	7P.00.1.255.0025	7P.10.8.275.0012	7P.10.1.000.0025
		Varistor + GDT	Spark-Gap	Varistor	Spark-Gap
Maximum operating voltage ( $U_C$ )	V AC/DC	275/—	255/—	275/—	255/—
Lightning Impulse current (10/350 $\mu$ s) ( $I_{imp}$ )	kA	12.5	25	12.5	25
Nominal discharge current (8/20 $\mu$ s) ( $I_n$ )	kA	30	30	30	40
Maximum discharge current (8/20 $\mu$ s) ( $I_{max}$ )	kA	60	60	60	60
Voltage protection level ( $U_p$ )	kV	1.5	1.5	1.5	1.5
Response time ( $t_a$ )	ns	100	100	25	100
Maximum overcurrent protection		160	160	160 A gL/gG	—



Replacement varistor modules		7P.20.8.075.0015	7P.20.8.130.0015	7P.20.8.275.0020	7P.20.8.440.0020	7P.40.8.275.0020
		Varistor	Varistor	Varistor	Varistor	Varistor + GDT
Maximum operating voltage ( $U_C$ )	V AC/DC	75/100	130/170	275/350	440/585	275/—
Nominal discharge current (8/20 $\mu$ s) ( $I_n$ )	kA	15	15	20	20	20
Maximum discharge current (8/20 $\mu$ s) ( $I_{max}$ )	kA	40	40	40	40	25
Voltage protection level ( $U_p$ )	kV	0.4	0.7	1.35	1.9	1.2
Response time ( $t_a$ )	ns	25	25	25	25	100
Maximum overcurrent protection		160 A gL/gG	160 A gL/gG	160 A gL/gG	125 A gL/gG	125 A gL/gG



Replacement varistor modules		7P.20.9.375.0020	7P.20.9.500.0015	7P.20.9.750.0015
		Varistor	Varistor	Varistor
Maximum operating voltage ( $U_C/U_{CPV}$ )	V AC/DC	—/375	—/510	—/750
Nominal discharge current (8/20 $\mu$ s) ( $I_n$ )	kA	20	15	15
Maximum discharge current (8/20 $\mu$ s) ( $I_{max}$ )	kA	40	40	40
Voltage protection level ( $U_p$ )	kV	1.8	2	3.2
Response time ( $t_a$ )	ns	25	25	25
Maximum overcurrent protection		—	—	—

Replacement modules		7P.20.1.000.0020	7P.40.1.000.0020
		Spark-Gap	Spark-Gap
Maximum operating voltage ( $U_C/U_{CPV}$ )	V AC/DC	255/—	255/—
Nominal discharge current (8/20 $\mu$ s) ( $I_n$ )	kA	20	20
Maximum discharge current (8/20 $\mu$ s) ( $I_{max}$ )	kA	40	40
Voltage protection level ( $U_p$ )	kV	1.5	1.5
Response time ( $t_a$ )	ns	100	100
Maximum overcurrent protection		—	—

Temporary Overvoltage (TOV)		7P.32, 7P.36, 7P.37
Transient OverVoltage 5 s L-N ( $U_{TOV}$ )	V	335
Transient OverVoltage 5 s L-PE ( $U_{TOV}$ )	V	400
Transient OverVoltage 200 ms L-PE ( $U_{TOV}$ )	V	1430



Outline drawings

Type 7P.09  
Screw terminal

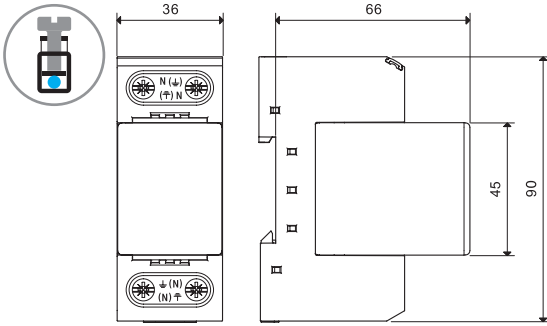

Type 7P.01  
Screw terminal

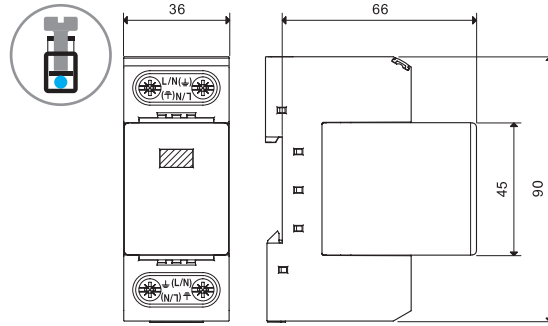

Type 7P.02  
Screw terminal

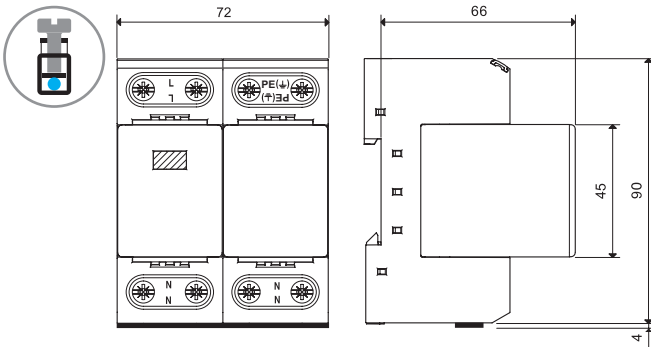

Type 7P.03  
Screw terminal

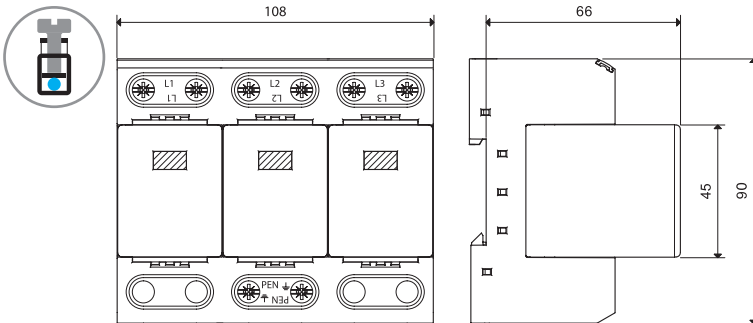

Type 7P.04  
Screw terminal

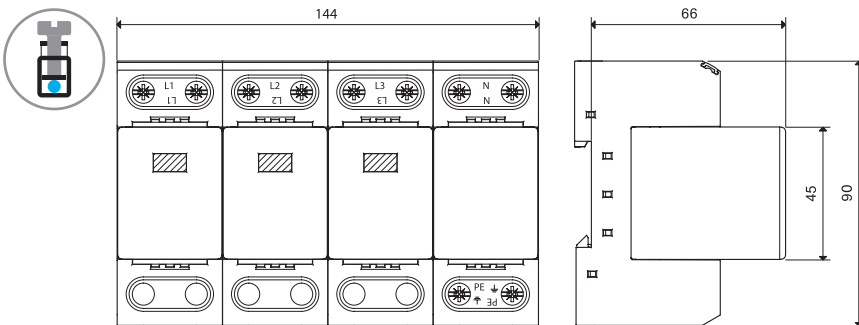

E



### Outline drawings

Type 7P02.8.275.1012  
Screw terminal

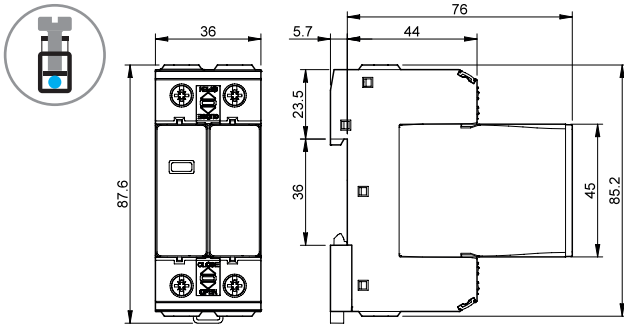

Type 7P04.8.275.1012  
Screw terminal

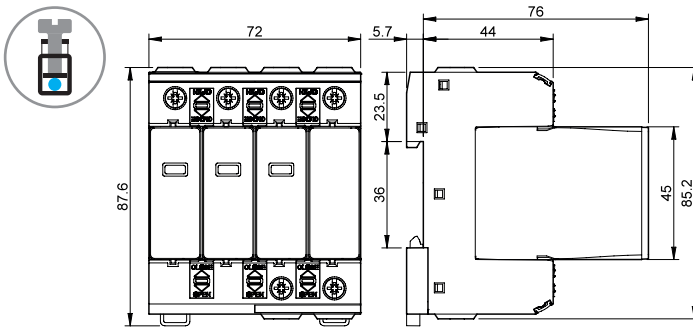

Type 7P05.8.275.1012  
Screw terminal

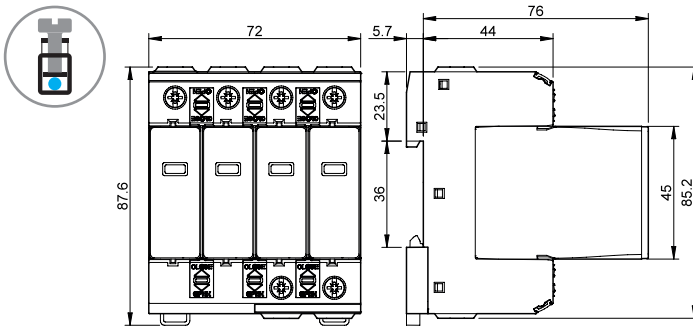

E

Outline drawings

Type 7P.05  
Screw terminal

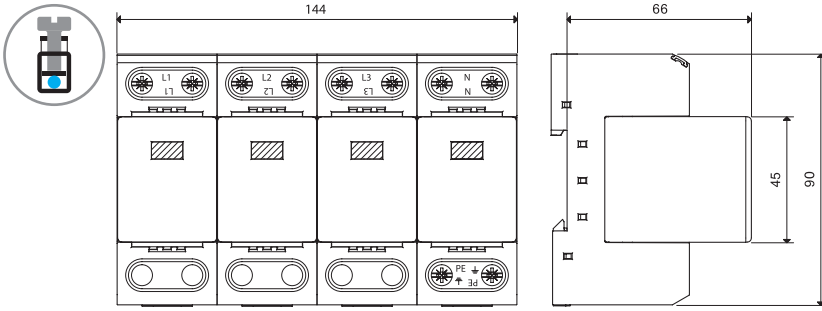

Type 7P.12  
Screw terminal

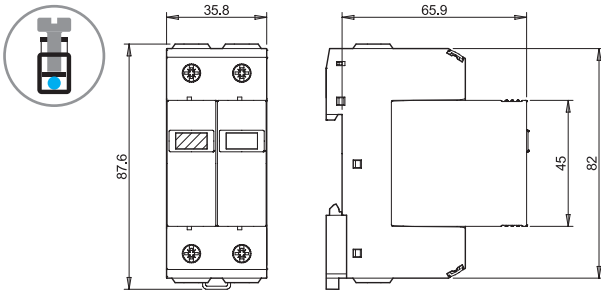

Type 7P.13  
Screw terminal

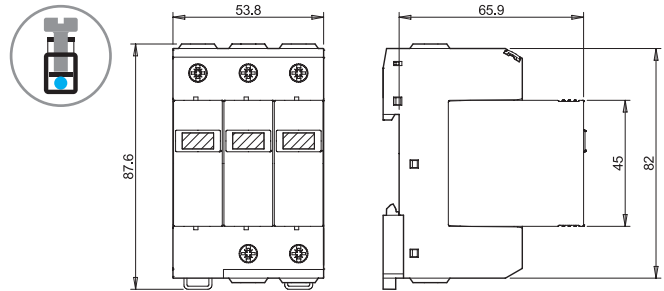

Type 7P.14  
Screw terminal

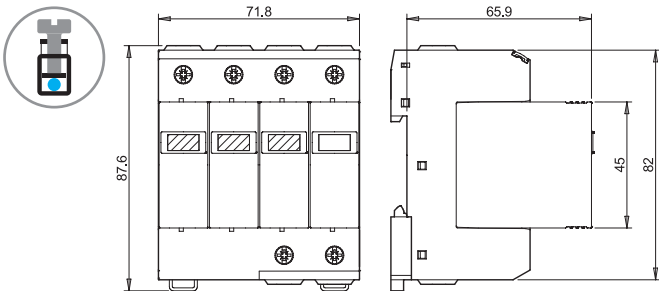

Type 7P.15  
Screw terminal

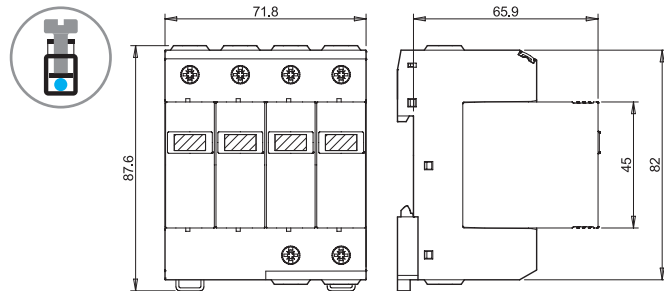

Type 7P.21  
Screw terminal

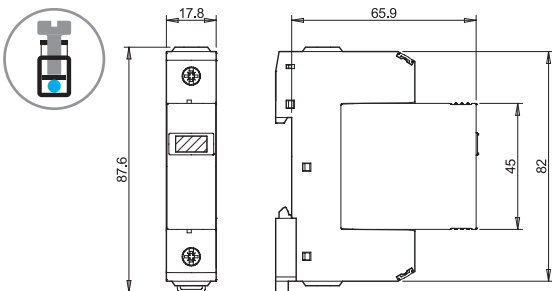

Types 7P.22 / 7P.27 / 7P.42  
Screw terminal

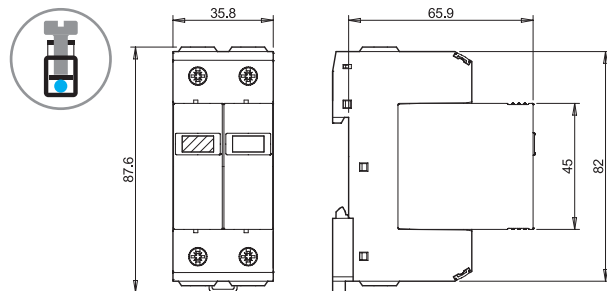

E

Outline drawings

Types 7P.23.8 / 7P.43  
Screw terminal

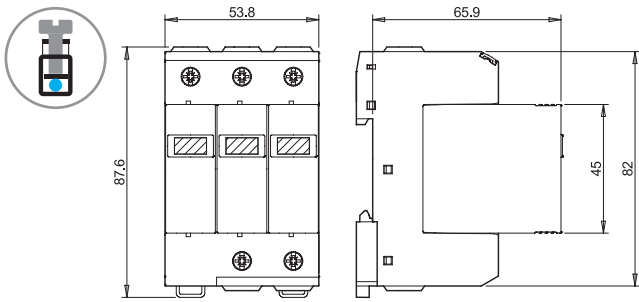

Types 7P.24 / 7P.44  
Screw terminal

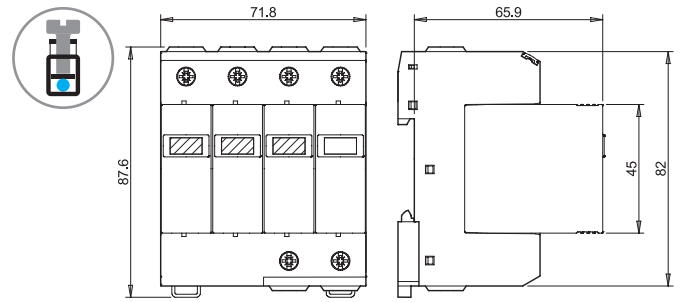

Type 7P.23.9  
Screw terminal

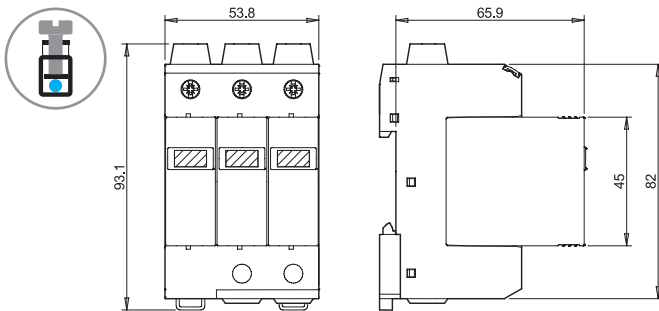

Types 7P.25 / 7P.45  
Screw terminal

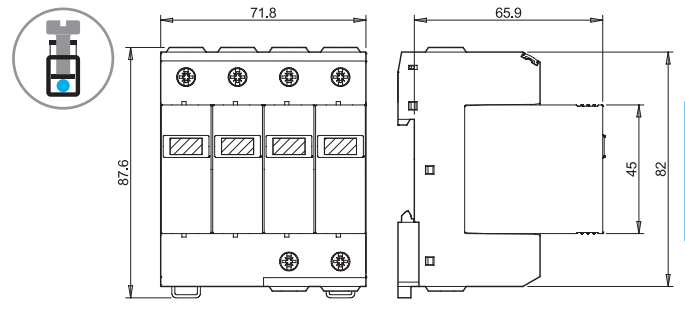

Type 7P.13.9.000.x006  
Screw terminal

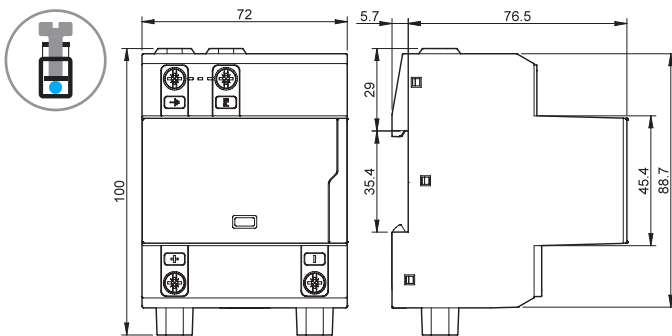

Type 7P.13.9.500.x006  
Screw terminal

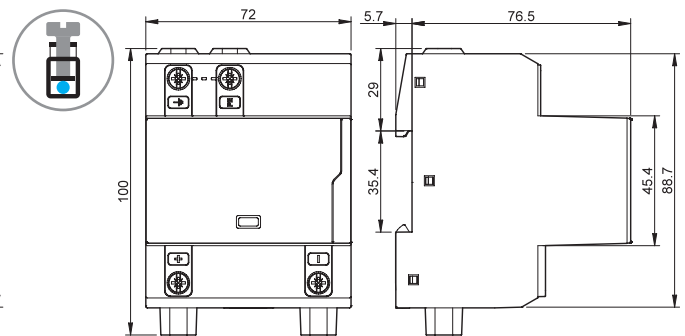

Type 7P.37.8.275.1003  
Screw terminal

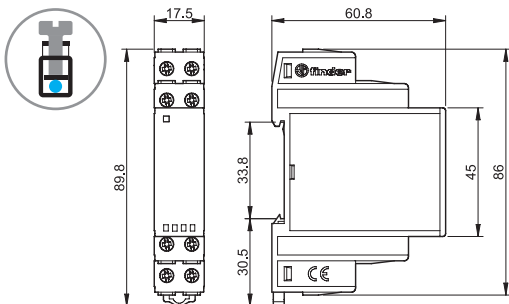

E

## Outline drawings

Type 7P.68.9.060.0600

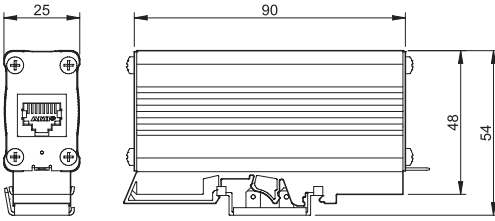

Types 7P.62.9.036.0005/7P.62.9.009.0485  
Screw terminal



E

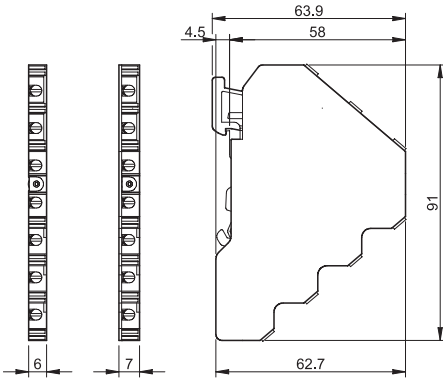

Type  
7P.36.8.275.2003

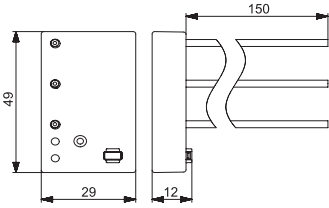

Types  
7P.31.8.275.0005/7P.32.8.275.0005

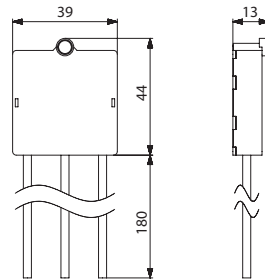

Type 7P.00  
Replaceable module

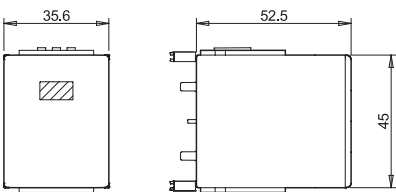

Type 7P.10/20  
Replaceable module

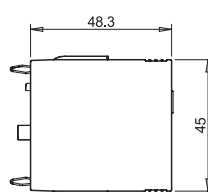

07P.01  
Connector

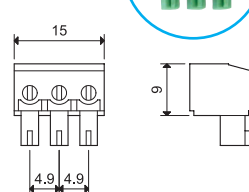

Installation example - SPD Type 1 + 2

TT-SINGLE PHASE SYSTEM - SPD UP-STREAM OF RCD

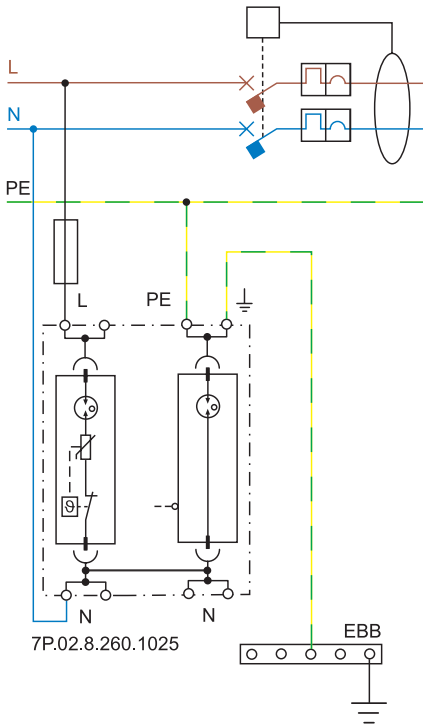

TT-THREE PHASE SYSTEM - SPD UP-STREAM OF RCD

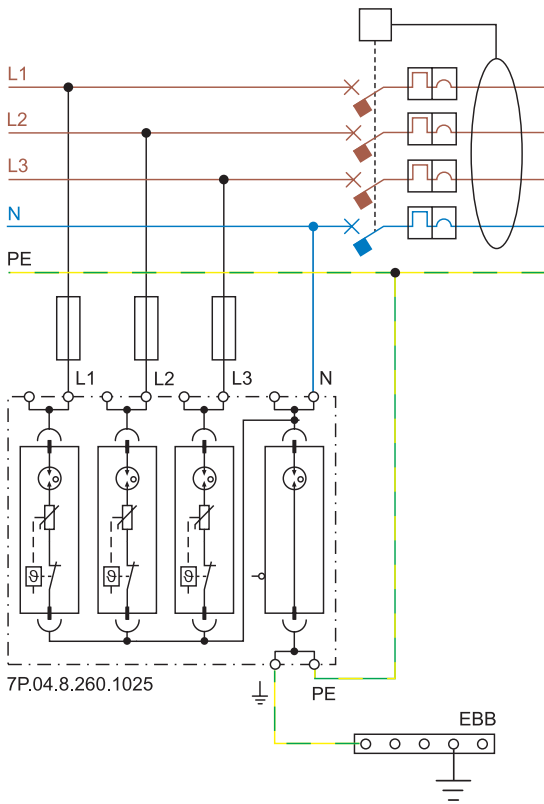

Wiring diagrams "V-shape" (fuse max = 125 A)

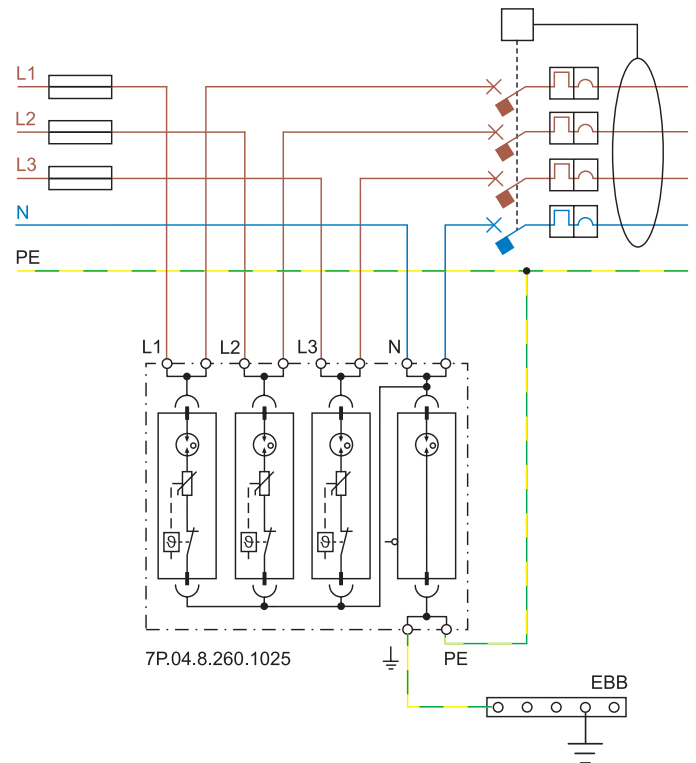

E

Installation example for SPD Type 1 + 2 and Type 2 - Single phase

TT-SINGLE PHASE SYSTEM - SPD UP-STREAM OF RCD

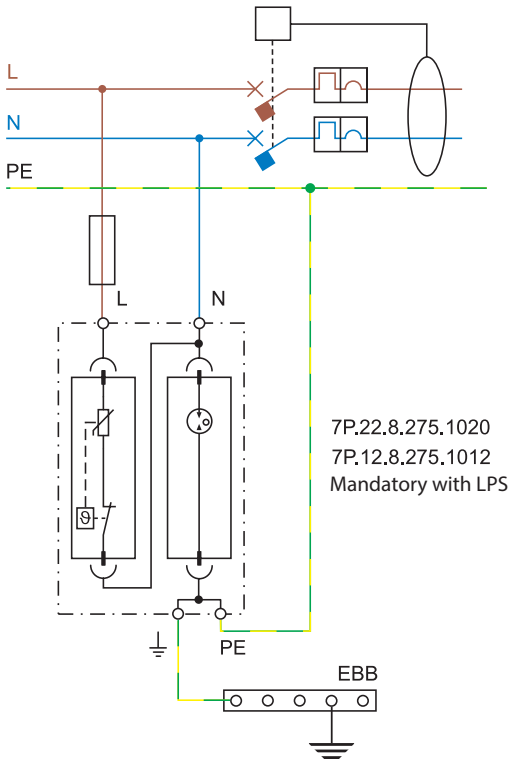

TT or TN-S SINGLE PHASE SYSTEM - SPD DOWN-STREAM OF RCD

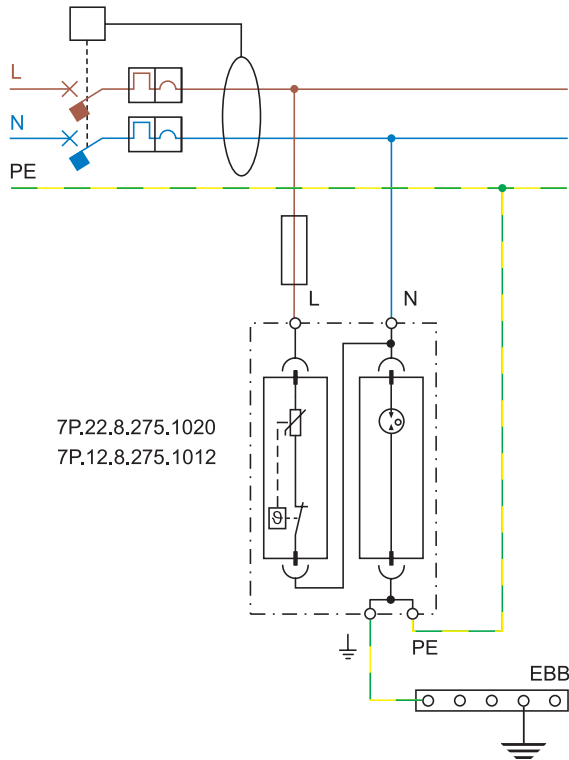

TN-S SINGLE PHASE SYSTEM - SPD DOWN-STREAM OF RCD

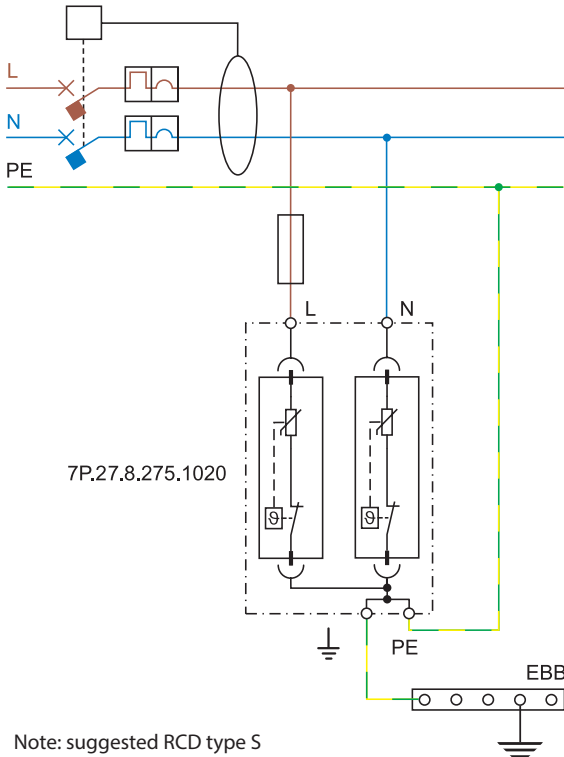

Note: suggested RCD type S

Installation example for SPD Type 3

TT or TN-S SINGLE PHASE SYSTEM - INCORPORATED IN SOCKET OUTLET

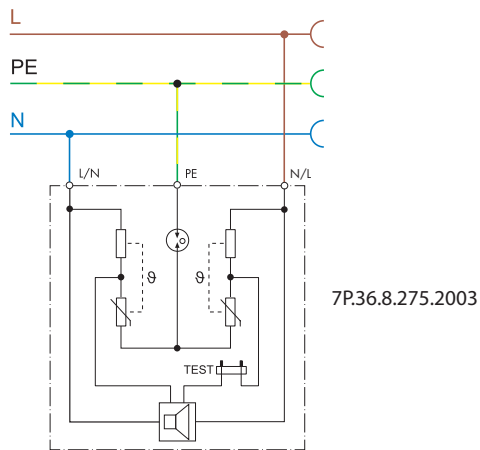

Installation example for SPD Type 1 + 2 and Type 2 - Three phase

TT-THREE PHASE SYSTEM - SPD UP-STREAM OF RCD

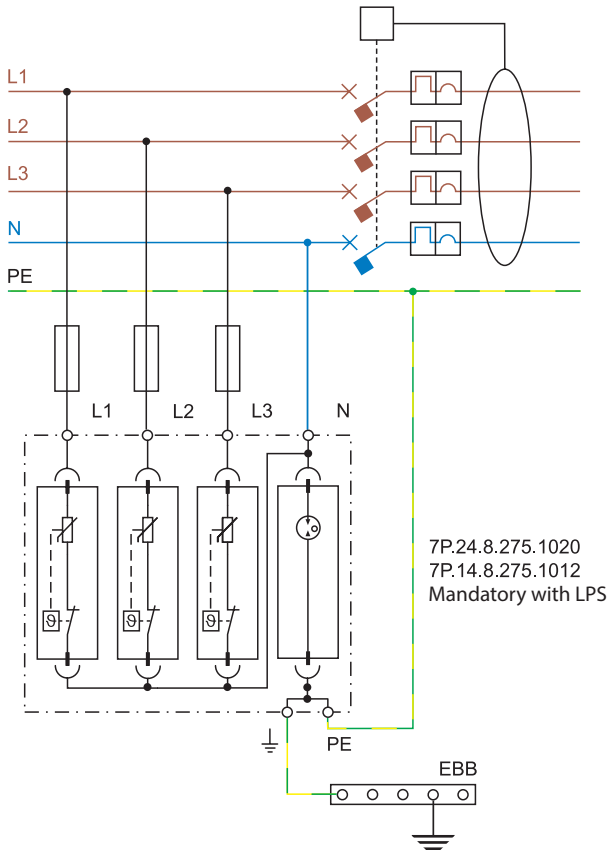

TT or TN-S THREE PHASE SYSTEM - SPD DOWN-STREAM OF RCD

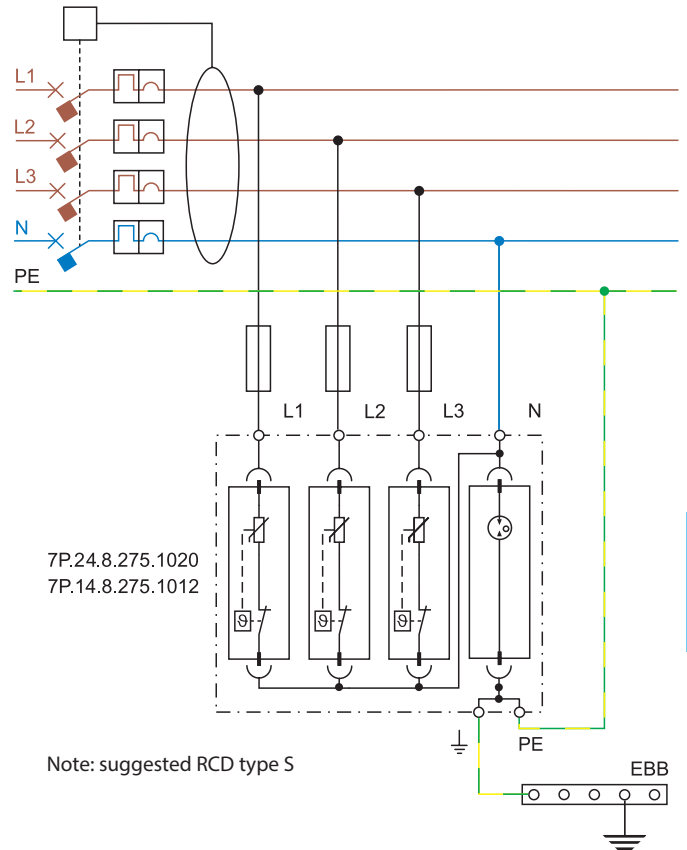

TN-S THREE PHASE SYSTEM - SPD DOWN-STREAM OF OVERCURRENT PROTECTION

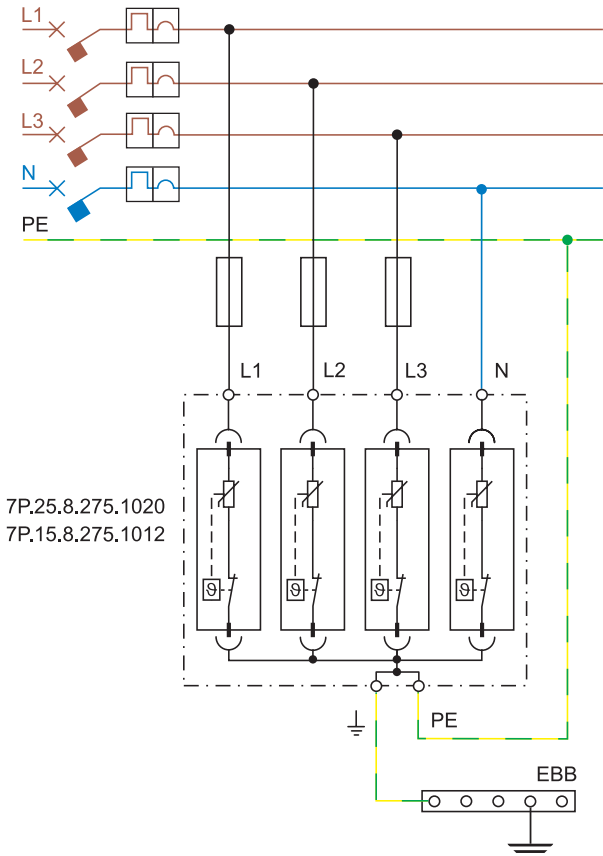

TN-C THREE PHASE SYSTEM - SPD UP-STREAM OF OVERCURRENT PROTECTION

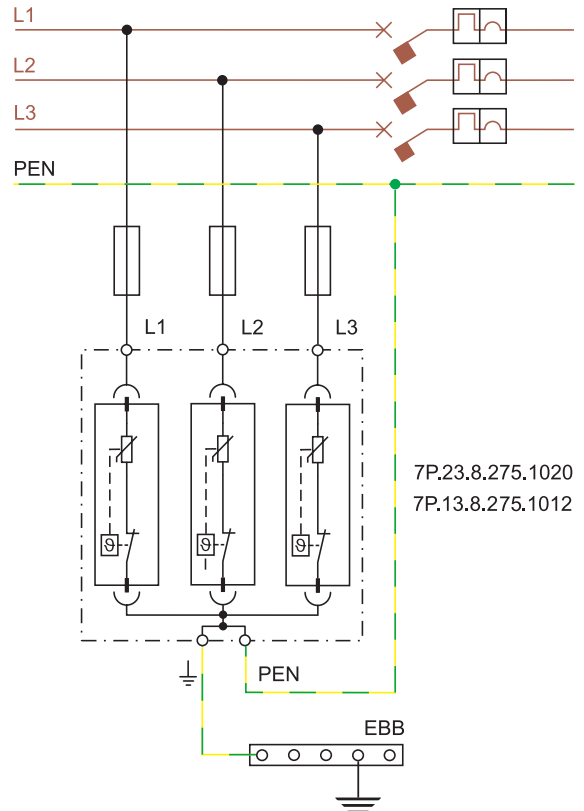

Installation example for SPD Type 3 - Single phase

TT or TN-S SINGLE PHASE SYSTEM - SPD DOWN-STREAM OF RCD  
Serial connection

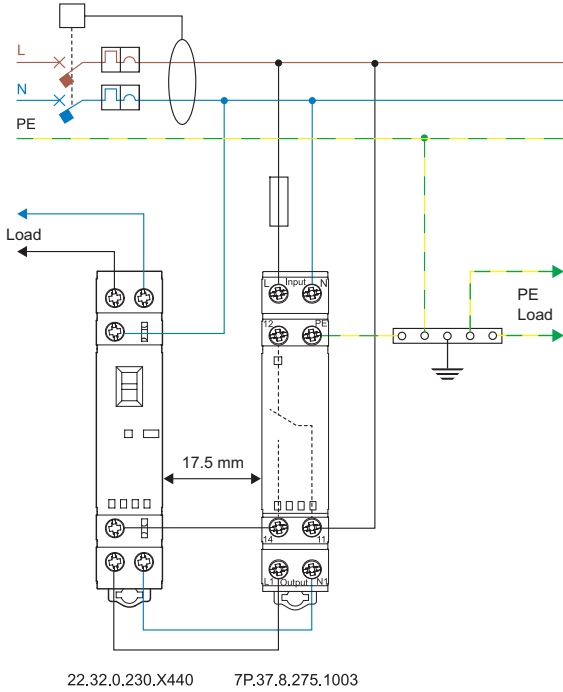

TT or TN-S SINGLE PHASE SYSTEM - SPD DOWN-STREAM OF RCD  
Serial connection + BUS line

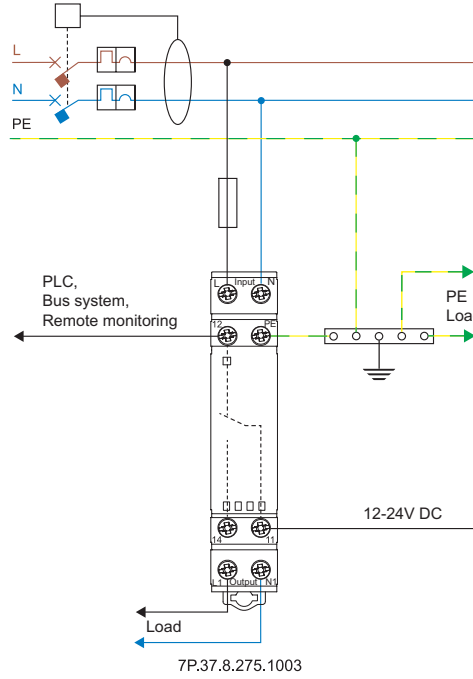

TT, TN-S SINGLE PHASE: parallel connection

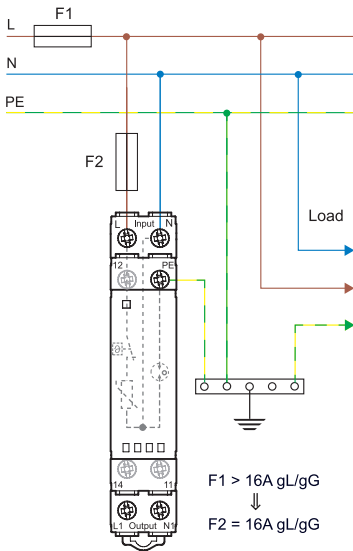

Function

Visual local LED signalling and remote signalling of varistor status

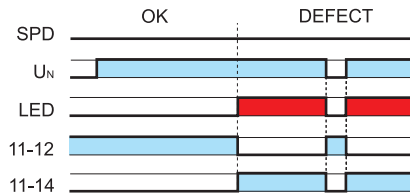



L7P Temperature/Current diagram for model 7P.37

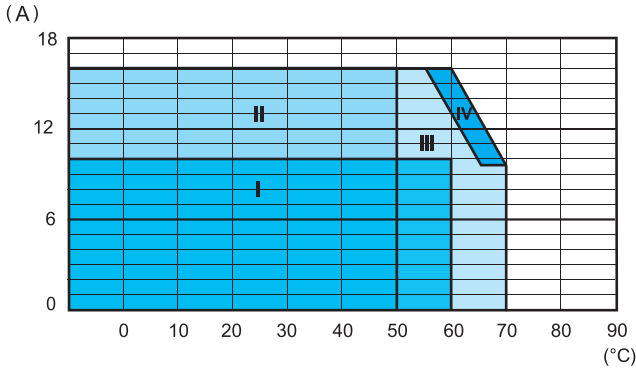

Zone I: SPD and other devices installed as a group (without gap)

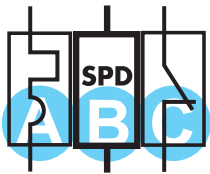

- A** MCB = B10A, C10A
- B** 7P.37.8.275.1003
- C** 22.32.0.xxx.x4x0

Zone II: SPD spaced, at least from one side, from components that generate heat during their operation (17.5 mm gap)

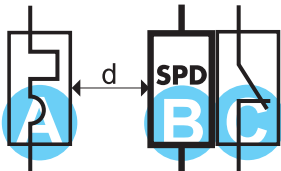

- A** MCB = B16A, C16A
- B** 7P.37.8.275.1003
- C** 22.32.0.xxx.x4x0
- d** 17.5 mm



- A** MCB = B16A, C16A
- B** 7P.37.8.275.1003

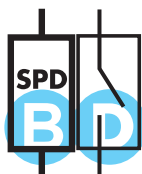

- B** 7P.37.8.275.1003
- D** 22.32.0.xxx.x3x0  
22.32.0.xxx.x4x0

Zone III: SPD spaced, on both side, from components that generate heat during their operation (20 mm gap)

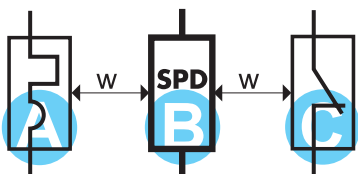

- A** MCB = B16A, C16A
- B** 7P.37.8.275.1003
- C** 22.32.0.xxx.x4x0
- w** 20 mm

Zone IV: SPD installed individually in free air (without significant influence from nearby components)



- B** 7P.37.8.275.1003

Installation examples - photovoltaic

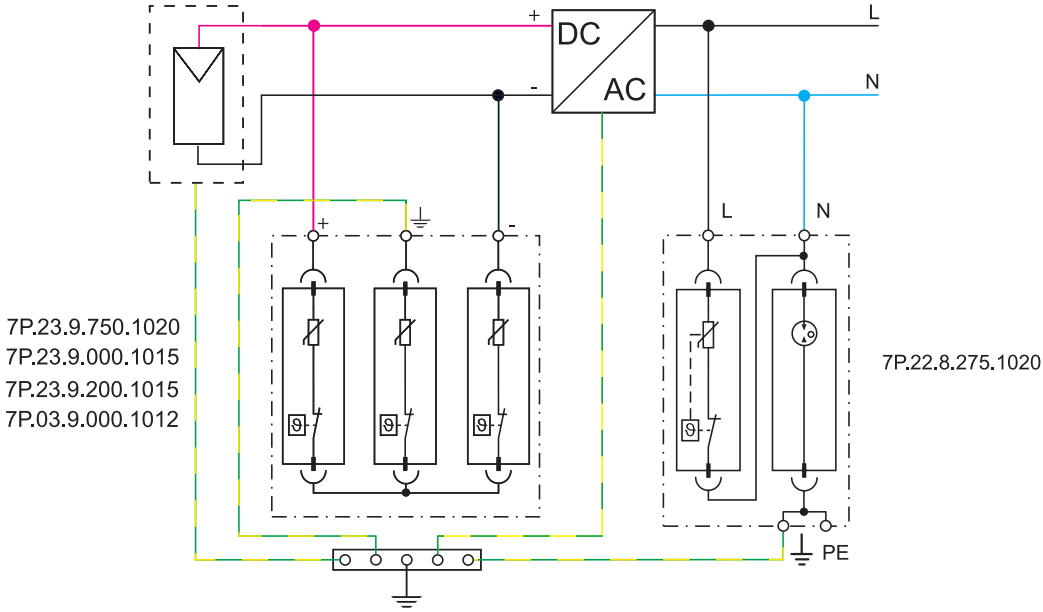

E

**SURGE VOLTAGE PROTECTORS**

Surge voltage protectors (such as Finder's Surge Protection Devices, SPD) are intended to be installed in electrical systems, to protect people and machines from surge voltages that can occur on the electrical supply line and which would otherwise have disastrous consequences. These surge voltages can be atmospheric (lightning) or can originate on the electrical system due to, for example: the opening and closing of large loads, short circuits, or the switching of large power factor correction capacitors. The SPD can be described as a switch that is in parallel with the electrical system's supply line - which it is protecting. At the nominal network voltage (e.g. 230 V) the SPD appears as an open switch, having a very high impedance (almost infinite). But, under an overvoltage condition its impedance rapidly falls to near 0 Ω. This effectively applies a short circuit across the supply lines and immediately "drains" the overvoltage to earth. In this way the supply line is protected wherever an SPD is installed. When the overvoltage has passed, the SPD impedance rises rapidly and resumes the state of an open switch again.

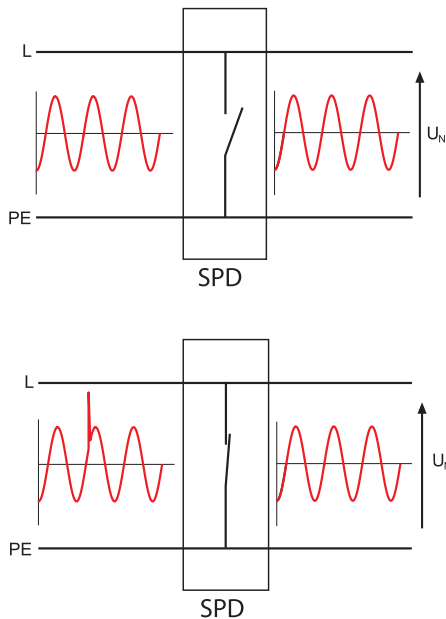

Figure 1: Ideal operation of an SPD

**SPD technologies**

Finder surge voltage protectors use either varistors or spark gaps.

**Varistor:** This can be considered as a variable resistance that at nominal voltage has a very high ohmic value. But the resistance rapidly falls to near zero as the voltage surges. In this way the varistor applies a near short circuit which clamps the surge voltage. The varistor is however subject to progressive degradation due to the small leakage current that occurs at the nominal voltage, and with the number of interventions. With every overvoltage that occurs the leakage current rises and accelerates the end of life for the device - which is ultimately indicated by the change from green to red in the signal-window.

**Spark gap:** This comprises two electrodes separated by air, or a gas. When a surge voltage occurs an electrical arc bridges the gap and a surge current flows to limit the surge voltage to a low and constant level. The arc extinguishes only when the surge current falls below about 10 ampere. The gas guarantees a constant level of breakdown voltage since the arc is struck in a protected environment; not exposed to pressure or humidity variations or impurities as would happen if it had occurred in air. There is however, a delay before the device arcs and the surge current is diverted, and this is dependent on the magnitude of the original voltage surge and on its rate of rise. Therefore, the voltage protection level can vary, although it is guaranteed to be less than  $U_p$ .

Component	Symbol	Leakage current	Energy dissipated	Response time	Voltage/Current characteristic
Ideal		0	High	Fast	
Spark gap		0	High	Medium	
Varistor		Very Low	Medium	Fast	

Figure 2: SPD component characteristics.

**Installation (Overvoltage) categories**

Choosing the SPD requires matching the Rated Impulse Voltage of the SPD with that of the equipment to be protected. This in turn relates to the Installation category (Overvoltage category). Installation categories are described within IEC 60664-1, which for a 230/400 V installation prescribes as follows:

- **Installation category I:** 1.5 kV for "particularly sensitive" equipment (e.g. electronic devices like PC or TV set);
- **Installation category II:** 2.5 kV for "user" equipment subject to "normal" impulse voltages (e.g. household electrical appliances, mobile items);
- **Installation category III:** 4 kV for equipment that are part of a fixed installation (e.g. switchboards, switches)
- **Installation category IV:** 6 kV for equipment installed at or near the origin of main incoming supply mains (e.g. energy meters).

**Lightning Protection Zones and installation considerations**

International standards refer to the various Lightning Protection Zones by the letters LPZ followed by an appropriate number.

- LPZ 0A: An external area, where a direct lightning strike is possible and where there is total exposure to the electromagnetic field induced by the lightning.
- LPZ 0B: An external area, but below a lightning conductor providing direct lightning strike protection. There remains total exposure to the electromagnetic field.
- LPZ 1: Area within a building – therefore protected from direct lightning strike. The electromagnetic field will be attenuated, depending on the degree of shielding. This zone has to be protected by SPD type 1 device(s) at its boundary with the LPZ 0A or 0B zone.
- LPZ 2: An area, typically a room, where the lightning current has been limited by preceding surge protectors. This zone has to be protected by SPD type 2 device(s) at its boundary with the LPZ 1 zone.
- LPZ 3: An area within a room where the lightning current has been limited by preceding surge protectors (typically the wiring after a socket or an area within a metal enclosure).

This zone has to be protected by SPD type 3 device(s) at its boundary with the LPZ 2 zone. On the following picture (Figure 3, representation is not binding) it is shown that the transition from a protection zone to the next is through the installation of SPD. SPD Type 1 must be connected upstream the system, at the point of delivery connection. As an alternative it is possible to use SPD Type 1+2. The grounding conductor must have a minimum section of 6 mm<sup>2</sup> for SPD Type 1, of 4 mm<sup>2</sup> for SPD Type 2, and 1.5 mm<sup>2</sup> for SPD Type 3 (If the building has an LPS, reference should be made to CEI 81-10/4 for the correct dimension of the cable).

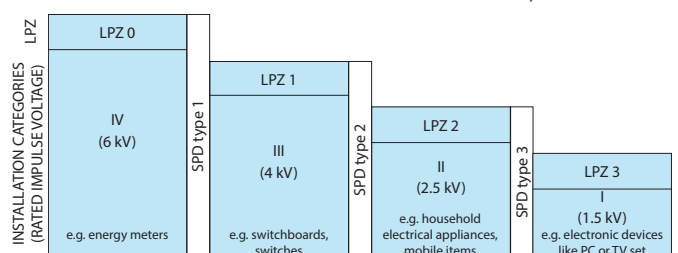

Figure 3: Typical relationship between Lightning Protection Zones, Installation Categories and SPD types

**Rated values and marking common to all SPD**

**[U<sub>C</sub>] Maximum operating voltage:** Under this voltage the SPD is guaranteed to appear as an "open switch". This voltage is normally at least equal to the nominal supply voltage (U<sub>N</sub>) +10%. For the Finder SPD, U<sub>C</sub> is specified as 275 V.

**[U<sub>p</sub>] Voltage protection level:** This is the highest voltage level seen across the SPD during its intervention. For example, for Finder SPD Type 2, this means that a 4 kV overvoltage would be limited by the SPD to a maximum 1.2 kV. Consequently, electronic devices such as PC, TV, stereo, etc. are protected - as their own internal protection will handle overvoltages U<sub>p</sub> to 1.5 kV.

To better understand this concept; imagine that the SPD is a switch in series a low resistance. In the case of an overvoltage the switch closes and all the current goes through the resistance. According to Ohm's law the voltage developed across the resistance will be this resistance x the current (V = R x I), and will be limited to < U<sub>p</sub>.

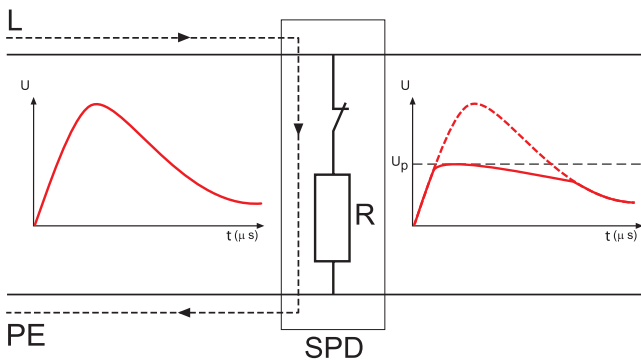

Figure 4: Overvoltage limiting

**Short circuit proof:** A further characteristic, not normally marked on the product but important for its correct installation, is the Short circuit proof at maximum overcurrent protection. This is the maximum short-circuit current that the SPD is able to withstand when it is installed with additional maximum overcurrent protection - such as a fuse rated in accordance with the value stated under the SPD specification. Consequently the maximum prospective short-circuit current of the system at the point of installation of the SPD must not exceed this value.

**Rated values and marking of SPD Type 1**

SPD Type 1 must be connected upstream the system, at the point of delivery of power energy. SPD protects building and people from the risk of direct lightning (fire and death) and are characterized by:

**[I<sub>imp</sub>10/350] Impulse current:** I<sub>imp</sub> corresponds to the peak value of a 10/350 μs current impulse waveform. This waveform represents a direct lightning strike and is used in tests to prove the performance of SPD type 1 devices.

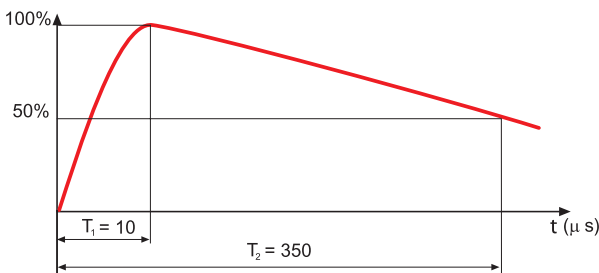

Figure 5: 10/350 μs current waveform

Comparison of the waveforms in figures 5 and 6 shows the much higher energy content controlled by the type 1 SPD.

**[I<sub>n</sub>8/20] Nominal discharge current:** The peak current (and waveform shape) through the SPD under conditions prescribed by EN 62305 to represent the surge current as a consequence of a lightning strike to the electric supply line.

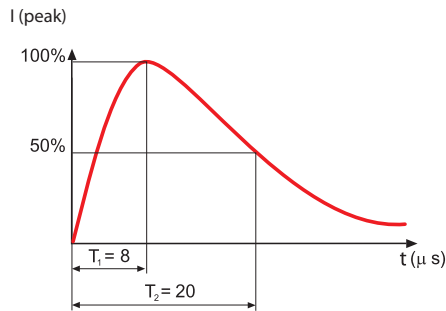

Figure 6: 8/20 μs current waveform

**Rated values and marking of SPD Type 2**

SPD Type 2 devices are designed to remove all the overvoltage from supply circuits that are not likely to be directly hit by lightning. SPD Type 2 are connected downstream SPD Type 1 or SPD Type 1+2, (minimum distance 1 m) and they protect machine and tools connected to the ground and reduce the risk of economic loss. SPD Type 2 are characterized by:

**[I<sub>n</sub>8/20] Nominal discharge current:** The peak current (and waveform shape) through the SPD under conditions prescribed by EN 62305 to represent the surge current as a consequence of a lightning strike to the electric supply line.

**[I<sub>max</sub>8/20] Maximum discharge current:** Peak value of the highest current of a 8/20 μs waveform that an SPD can discharge at least once without breaking.

**Rated values and marking of SPD Type 3**

SPD type 3 devices are used to protect the end user from overvoltage. They may be installed in supply networks where SDP types 1 and/or 2 already exist. They can be installed in fixed or mobile sockets and have the following characteristic parameters.

**U<sub>oc</sub>:** test voltage. This is the peak value of the no load voltage of the combined test-generator; this has a waveform of 1.2/50 μs (figure 7) and can supply at the same time current with waveform 8/20 μs (figure 6).

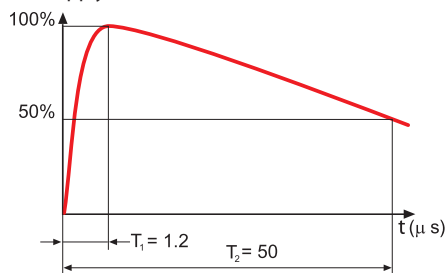
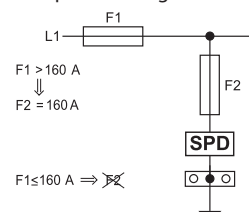

Figure 7: 1.2/50 μs voltage waveform

**Suggestion for the connection**

The correct connection of SPD requires a shortest as possible connection to the local equipotential bar, to which are connected PE cables of the equipment to be protected. From the local equipotential bar there is a connection to the EBB. The phase wiring remains appropriate to the load.



Short-circuit protection for the SPD is provided by the overcurrent protective devices (fuses type gL/gG) recommended.

In AC applications if the overcurrent protective devices F1 (which are part of the installation) have a rating smaller than or equal to the maximum recommended rating for the overcurrent protective devices for the SPD, then F2 (back up fuse), can be omitted.

7P.0X:

If  $F1 > 250 \text{ A}$ , then  $F2 = 250 \text{ A}$

If  $F1 \leq 250 \text{ A}$ , F2 can be omitted

7P.1X, 7P.2X:

If  $F1 > 160 \text{ A}$ , then  $F2 = 160 \text{ A}$

If  $F1 \leq 160 \text{ A}$ , F2 can be omitted

For DC applications the back up fuse must be always used.

### Coordination of SPD

Optimal protection from surges requires cascaded coordinated SPDs. Coordination has the purpose of splitting the energy associated with voltage across the SPDs and it is achieved by introducing an impedance between the SPDs, or alternatively, by connecting them using wires having the minimum length indicated in the figures below, in order to use the cable's own impedance.

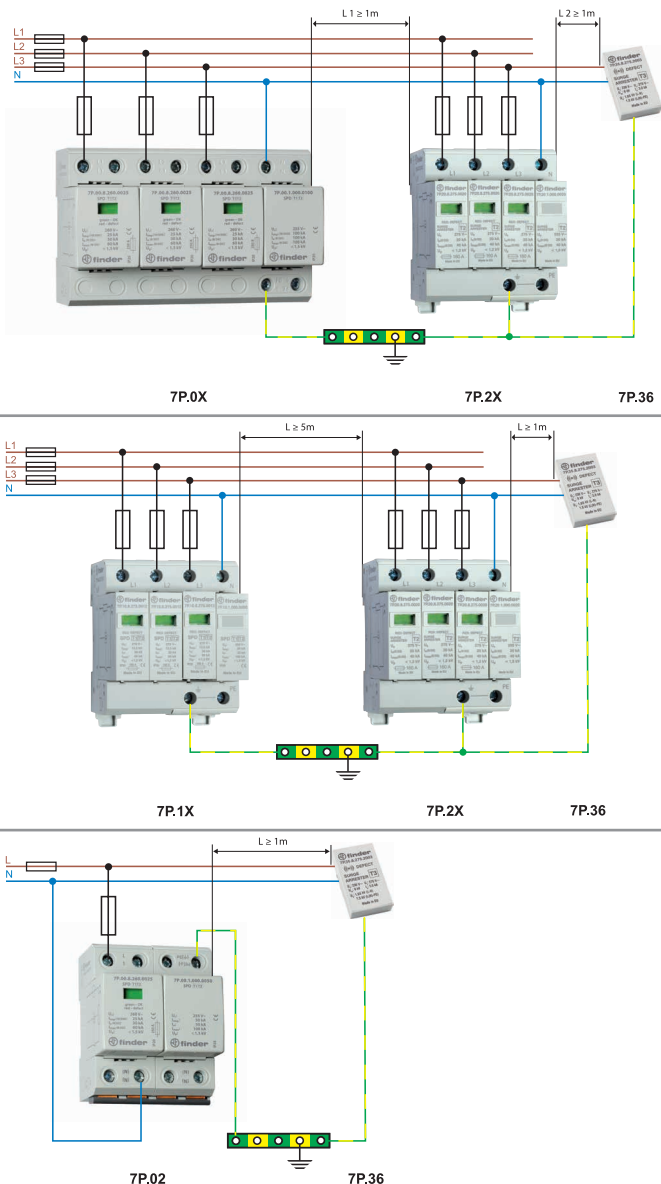

### V-shape connection

Using a V-shaped connection eliminates transferring downstream the inductive voltage generated by the surge current in the connecting wire to the SPD. This increases the protection to the system and equipment downstream. A limitation of this connection is that the nominal current for the downstream system is limited to 125 A, which is the maximum current permitted through the double SPD terminals.

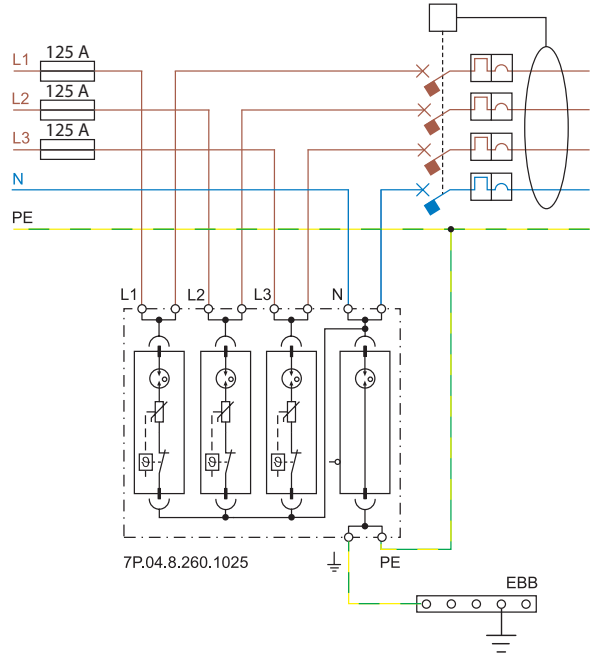

For systems where the rated current is greater than 125 A, it is necessary to connect the SPD in parallel with the equipment (E/I).

### Connecting cable

Depending on the type of connection, serial (V-shape) or parallel (T-shape), ensure that both the maximum cable lengths and minimum cross section of the connecting wires are respected in accordance with the information below (IEC 60634-5-534):

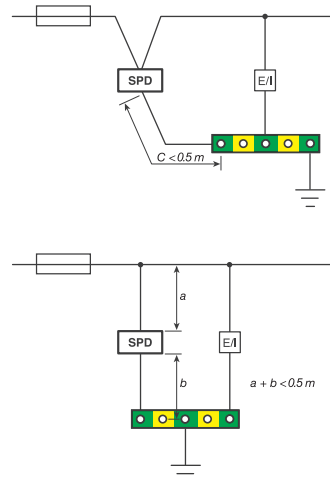

The section of the connecting wires (copper) must not be less than:  
 SPD Type 1: 16 mm<sup>2</sup> if it is subject to discharge a significant lightning current, 6 mm<sup>2</sup> otherwise

SPD Type 2: 6 mm<sup>2</sup>

SPD Type 3: 1.5 mm<sup>2</sup>

## PROTECTING PHOTOVOLTAIC (PV) SYSTEMS AGAINST LIGHTNING

## Installation characteristics

**[ $U_{OCSTC}$ ] PV voltage:** Open circuit voltage, measured under standardized test conditions, of the PV module, panel, array, or the DC side of the photovoltaic inverter. prEN 50539-12.

**[ $I_{SCPV}$ ] Short-circuit current:** Short-circuit current, measured under standardized test conditions, of the PV module, panel, array, or photovoltaic inverter. prEN 50539-12.

**[ $U_{CPV}$ ] SPD Maximum operating voltage:** Must be equal or greater than to 1.2 times  $U_{OCSTC}$  in all conditions of radiation and temperature. prEN 50539-11, prEN 50539-12.

**[ $I_{SCPV}$ ]:** Maximum prospective short-circuit current from the power system for which the SPD, in conjunction with the disconnectors specified, is rated. EN 50539-11.

## System installation

Photovoltaic systems are generally located external to a building and can be subjected to the direct or indirect effects of lightning.

Whilst the installation of photovoltaic panels on the roof does not, in itself, increase the risk of direct lightning, the only practical way to protect against the effects of a direct lightning strike would be the use of a lightning protection system (LPS).

The indirect effects of lightning can however, be mitigated by the appropriate use of Surge Protection Devices (SPD). These indirect effects occur when lightning strikes in proximity to the structure and where magnetic induction creates an overvoltage in the conductors – a danger to both people and equipment. In particular, the DC cables of a PV system would be exposed to the high conducted and radiated disturbances caused as a result of the lightning currents. In addition, overvoltages in PV systems are not only of atmospheric origin. It is also necessary to consider overvoltages due to switching on electrical networks connected to them. These overvoltages can also damage both the inverter and the PV panels, and this explains the need to protect the inverter on both DC and AC sides.

## Photovoltaic system on a building without a lightning protection system (LPS)

As an example, Figure 10 represents a simplified photovoltaic system placed on a building without lightning rod. In such a system, the protection against lightning must be considered at the following points of installation:

- DC input of the inverter
- AC output of the inverter
- Low voltage supply network

At the DC input to the inverter SPDs specific for photovoltaic systems must be installed, according to the PV system voltage. At the inverter AC output, type 2 surge arresters must be installed suitable for the type of system. At the point of connection to the LV supply network, install type 2 surge arresters suitable to the type of system (TT, TN). In more complex systems, it might be necessary to introduce additional SPDs. DC side: if the distance between the inverter and PV modules exceeds 10 m, it is necessary to replicate and install the SPD as close as possible to the PV modules.

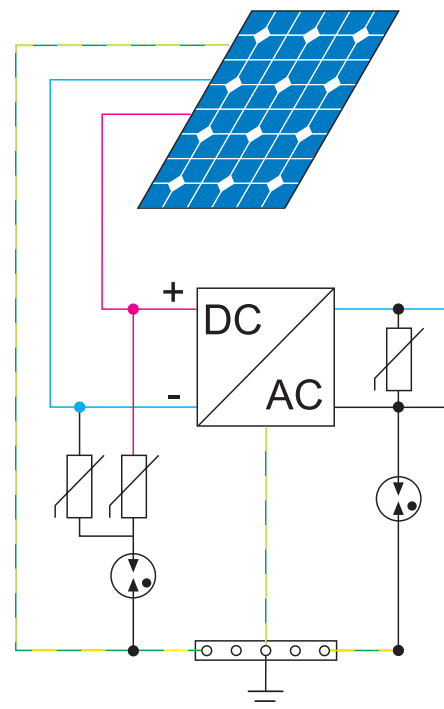

Figure 10: Example of a photovoltaic system located on a building without LPS, protected on the DC side by an SPD with  $U_{OCSTC} = 420$  V, and on the AC side by a 7P.22, specific for TT systems.

## Photovoltaic system on a building with a lightning protection system (LPS)

Where an LPS exists it is good practice to install the photovoltaic panels in the area protected by the lightning rod.

In addition it is necessary to realize a good equipotential bonding system, which must be positioned as close as possible to the entry point of LV supply into the structure. The LPS, the SPD and all metal parts have to be connected to this equipotential system.

SPD protection on the DC depends on the safety distance (referred in EN 50539-12:12-2012).

Note that under EN 62305 installation of a Type 1 SPD is mandatory at the point of delivery of the AC electricity supply, whether or not the building has LPS (with or without solar panels).

**SPD fuse protection**

Conforming to prEN 50539-11:2010, Finder SPDs are equipped with a thermal disconnecter able to safely disconnect a worn or damaged varistor up to a value of short-circuit current equal to the short-circuit current withstand value ( $I_{scpv}$ ), as specified in the technical data.

Ensure that the PV short circuit current  $I_{sc} < I_{scpv}$ .

Ensure that the PV short circuit current  $I_{sc} < I_{scpv}$  or increase the number of the strings.

**Insulation distances and wiring**

To conform with prEN 50539-11 insulation distances and minimum wiring cross section must be respected.

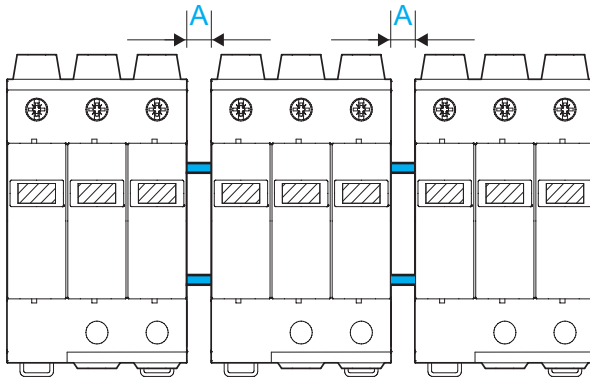

Insulation distances		Minimum Wiring [mm <sup>2</sup> ]	
$U_{CPV}(SPD) \geq 1.2 \times U_{OCSTC}$	A [mm]	+/- Poles	Ground
750 V DC	5	4	6
1000 V DC	5	4	6
1500 V DC	10	4	6

E





# Switch mode power supplies

78  
SERIES



Building automation



Elevators and lifts



Automation for blinds, grilles and shutters



Hoists and cranes



Panels for electrical distribution



Pump Control





**12 W Low profile Modular DC Power Supplies for electrical cabinets**

**Type 78.12...2400**

- Output 24 V DC, 12 W, 0.63 A

**Type 78.12...1200**

- Output 12 V DC, 12 W, 1.25 A

- Designed for SELV system (EN 60950)
- 17.5 mm (1 module) x 61 mm deep
- Low (< 0.4 W) stand-by power consumption
- Thermal protection: internal, with  $V_{out}$  shutdown - power OFF to reset
- Short circuit protection: Hiccup (auto-recovery) mode
- Overvoltage protection: Varistor
- Flyback topology
- Compliant with EN 60950-1 and EN 61204-3
- Parallel working for automatic redundancy - with OR diodes
- Dual Polarity and Series connection permissible
- 35 mm rail (EN 60715) mount

Screw terminal



For outline drawing see page 26

**Output specification**

		78.12...2400	78.12...1200
Output current (-20...+40 °C, 230 V AC input)	A	0.63	1.25
Rated current $I_N$ (50 °C, full input operating range)	A	0.50	1
Rated voltage	V	24	12
Rated power	W	12	12
Output power (-20...+40 °C, 230 V AC input)	W	15	15
Peak current capability for 3 ms*	A	2	2
Output voltage adjust	V	—	—
Voltage variation (from no-load to full-load)		< 1%	< 1%
Voltage ripple @ full load**	mV	< 200	< 200
Hold-up time @ full load:	with 100 V AC input	> 10	> 10
	with 260 V AC input	> 90	> 90

**Input specification**

		78.12...2400	78.12...1200
Nominal voltage ( $U_N$ )	V AC (50/60 Hz)	110...240	110...240
	V DC (not polarized)	220	220
Operating range	V AC (50/60 Hz)	100...265***	100...265***
	V DC	140...370	140...370
Max power consumption	VA	28.2	32
(@ 100 V AC, 50 Hz)	W	14.2	17.2
Stand-by power consumption	W	< 0.4	< 0.4
Power factor		0.50	0.53
Max current consumption (@ 88 V AC)	A	0.25	0.30
Max. inrush current (peak @ 265 V) for 3 ms	A	10	10

**Technical data**

		78.12...2400	78.12...1200
Efficiency (@ 230 V AC)	%	85	87
MTTF	h	> 400 · 10 <sup>3</sup>	> 400 · 10 <sup>3</sup>
Start-up delay	s	< 1	< 1
Dielectric strength between input/output	V AC	3000	3000
Dielectric strength between input/PE	V AC	—	—
Ambient temperature range****	°C	-20...+60	-20...+60
Protection category		IP 20	IP 20

**Approvals** (according to type)



**78.12...2400**



- 24 V DC, 12 W output
- SELV
- General use for 24 V DC load

**78.12...1200**



- 12 V DC, 12 W output
- SELV
- General use for 12 V DC load

\* (see diagrams P78)

\*\* peak to peak, 100 Hz component, with 100 V AC input

\*\*\* 88...100 V AC with output current limited to 80%  $I_N$

\*\*\*\* (see derating diagrams L78)

**12 W Low profile Modular DC Power Supplies for electrical cabinets**

**Type 78.12...2402**

- Output 24 V DC, 12 W, 0.5 A
- Modular LED driver for stripes and up to 12 W, TÜV certified following IEC61347-2-13
- Suitable for general use (15 W - 40 °C, 12 W - 50 °C)

**Type 78.12...2482**

- Output 24 V DC - 0.5 A, 12 W up to 50 °C
- 15 W up to 40 °C
- Power supply switching for OPTA PLR - 8A Series
- Designed for SELV system (EN 60950)
- 17.5 mm (1 module) x 61 mm deep
- Low (< 0.4 W) stand-by power consumption
- Thermal protection: internal, with V<sub>out</sub> shutdown - power OFF to reset
- Short circuit protection: Hiccup (auto-recovery) mode
- Overvoltage protection: Varistor
- Flyback topology
- Compliant with EN 60950-1 and EN 61204-3
- Parallel working for automatic redundancy - with OR diodes
- Dual Polarity and Series connection permissible
- 35 mm rail (EN 60715) mount

Screw terminal



F For outline drawing see page

**78.12...2402**



- 24 V DC, 12 W output
- SELV
- Modular LED driver with 24 V DC output

NEW

**78.12...2482**



- 24 V DC, 12 W output
- SELV
- Power supply for OPTA PLR, 8A series

\* (see diagrams P78)  
 \*\* peak to peak, 100 Hz component, with 100 V AC input  
 \*\*\* 88...100 V AC with output current limited to 80% I<sub>N</sub>  
 \*\*\*\* (see derating diagrams L78)

**Output specification**

Maximum continuous output current @ 40 °C, 230 V AC	LED driver	A	0.5	—
	General USE	A	0.63	0.63
Nominal current I <sub>N</sub> -20...40...50 °C, 230 V AC	LED driver (40 °C)	A	0.5	—
	General USE (50 °C)	A	0.5	0.5
Rated voltage		V	24	24
Rated power		W	12	12
Maximum power @ 40 °C, 230 V AC	LED driver	W	12	—
	General USE	W	15	15
Peak current capability for 3 ms*		A	2	2
Output voltage adjust		V	—	—
Voltage variation (from no-load to full-load)			< 1%	< 1%
Voltage ripple @ full load**		mV	< 200	< 200
Hold-up time @ full load:	with 100 V AC input ms		> 10 @ 110 V AC	> 10
	with 260 V AC input ms		> 90 @ 240 V AC	> 90

**Input specification**

Nominal voltage (U <sub>N</sub> )	V AC (50/60 Hz)	110...240	110...240
	V DC (not polarized)	220	220
Operating range	V AC (50/60 Hz)	100...265***	100...265***
	V DC	140...370	140...370
Max power consumption (@ 100 V AC, 50 Hz)	VA	28.2	28.2
	W	14.2	14.2
Stand-by power consumption	W	< 0.4	< 0.4
Power factor		0.50	0.50
Max current consumption (@ 100 V AC)	A	0.25	0.25
Max. inrush current (peak @ 265 V) for 3 ms	A	10	10

**Technical data**

Efficiency (@ 230 V AC)	%	85	85
MTTF	h	> 400 · 10 <sup>3</sup>	> 400 · 10 <sup>3</sup>
Start-up delay	s	< 1	< 1
Dielectric strength between input/output	V AC	3000	3000
Dielectric strength between input/PE	V AC	—	—
Ambient temperature range****	°C	-20...+40	-20...+40
Protection category		IP 20	IP 20

**Approvals** (according to type)



**25 W Low profile Modular DC Power Supplies for electrical cabinets**

**Type 78.25...2400**

- Output 24 V DC, 25 W
- 35 mm (2-module) x 61 mm deep

**Type 78.25...1200**

- Output 12 V DC, 25 W
- 35 mm (2-module) x 61 mm deep

- Low (< 0.4 W) stand-by power consumption
- Thermal protection: internal, with  $V_{out}$  shutdown - power OFF to reset
- Short circuit protection: Hiccup (auto-recovery) mode
- Overvoltage protection: Varistor
- Flyback topology
- Compliant with EN 60950-1 and EN 61204-3
- Parallel working for automatic redundancy - with OR diodes
- Dual Polarity and Series connection permissible
- 35 mm rail (EN 60715) mount

Screw terminal



For outline drawing see page 26

**Output specification**

Output current (-20...+40 °C, 230 V AC input)	A	1	2.1
Rated current $I_N$ (50 °C, full input operating range)	A	0.75	1
Rated voltage	V	24	12
Rated power	W	25	25
Output power (-20...+40 °C, 230 V AC input)	W	25	25
Peak current capability for 3 ms*	A	3	4
Output voltage adjust	V DC	—	—
Voltage variation (from no-load to full-load)		< 1%	< 1%
Voltage ripple @ full load**	mV	< 200	< 200
Hold-up time @ full load: with 100 V AC input ms		> 40	> 40
with 260 V AC input ms		> 100	> 100

**Input specification**

Nominal voltage ( $U_N$ )	V AC (50/60 Hz)	110...240	110...240
	V DC (not polarized)	220	220
Operating range	V AC (50/60 Hz)	100...265***	110...265***
	V DC	140...370	140...370
Max power consumption (@ 100 V AC, 50 Hz)	VA	56.4	56
	W	27.5	27.3
Stand-by power consumption	W	≤ 0.5	≤ 0.30
Power factor		0.50	0.50
Max current consumption (@ 88 V AC)	A	0.43	0.43
Max. inrush current (peak @ 265 V) for 3 ms	A	20	20
Replaceable input fuse		—	—

**Technical data**

Efficiency (@ 230 V AC)	%	89	89
MTTF	h	> 400 · 10 <sup>3</sup>	> 400 · 10 <sup>3</sup>
Start-up delay	s	< 1	< 1
Dielectric strength between input/output	V AC	2500	2500
Dielectric strength between input/PE	V AC	—	—
Ambient temperature range****	°C	-20...+60	-20...+60
Protection category		IP 20	IP 20

**Approvals** (according to type)



**78.25...2400**



• 24 V DC, 25 W output

**78.25...1200**



• 12 V DC, 25 W output

\* (see diagrams P78)

\*\* peak to peak, 100 Hz component, with 100 V AC input

\*\*\* 88...100 V AC with output current limited to 80%  $I_N$

\*\*\*\* (see derating diagrams L78)

**36 W High efficiency, low profile  
Modular DC Power Supplies for electrical  
cabinets**
**Type 78.36 - 2402**

- Output 24 V DC, 36 W

**Type 78.36 - 1202**

- Output 12 V DC, 36 W

- High efficiency (up to 90%)
- Designed for SELV system (EN 60950)
- Suitable for backup battery systems
- Low (< 0.4 W) stand-by power consumption
- Thermal protection: internal, with  $V_{out}$  shutdown - power OFF to reset
- Short circuit protection: Hiccup (auto-recovery) mode
- Overvoltage protection: Varistor
- Flyback topology
- ZVS (Zero-voltage-switching), quasi-resonant mode switching
- Compliant with UL 61010 and EN 61204-3
- Parallel working for automatic redundancy - with OR diodes
- Dual Polarity and Series connection permissible
- Compact dimensions: 70 mm (4-modules) wide, 61 mm deep
- 35 mm rail (EN 60715) mount

Screw terminal



For outline drawing see page 26

**Output specification**

Output current (-20...+40 °C, 230 V AC input)	A	1.7	3.3
Rated current $I_N$			
50 °C, input (100...265)V AC - (140...370)V DC	A	1.5	3
Max. output current (battery charge limitation)	A	1.9	3.3
Rated voltage	V	24	12
Rated power	W	36	36
Output power (-20...+40 °C, 230 V AC input)	W	40	40
Peak current capability for 3 ms*	A	6	12
Output voltage adjust	V	24 - 28	12 - 16
Voltage variation (from no-load to full-load)		< 1%	< 1%
Voltage ripple @ full load	mV	< 200	< 200
Hold-up time @ full load: with 110 V AC input ms		> 20	> 30
with 250 V AC input ms		> 100	> 150

**Input specification**

Nominal voltage ( $U_N$ )	V AC (50/60 Hz)	110...240	110...240
	V DC (not polarized)	220	220
Operating range	V AC (50/60 Hz)	100...250	100...250
	V DC	140...370	140...370
Max power consumption (@ 100 V AC, 50 Hz)	VA	67	67.5
	W	41	42
Stand-by power consumption (230 V)	W	<= 0.4	<= 0.3
Power factor		0.62	0.61
Max current consumption (@ 100 V AC)	A	0.6	0.65
Max. inrush current (peak @ 250 V) for 3 ms	A	10	10

**Technical data**

Efficiency (@ 230 V AC)	%	90	90
MTTF	h	> 600 · 10 <sup>3</sup>	> 600 · 10 <sup>3</sup>
Start-up delay	s	< 3	< 3
Dielectric strength between input/output	V AC	3000	3000
Ambient temperature range**	°C	-20...+70	-20...+70
Protection category		IP 20	IP 20

**Approvals** (according to type)

**NEW 78.36 - 2402**



- 24 V DC, 36 W output
- Output adjustable between 24-28 V
- SELV
- Suitable for battery charging

**NEW 78.36 - 1202**

- 12 V DC, 36 W output
- Output adjustable between 12-16 V
- SELV
- Suitable for battery charging

\* (see diagrams P78)

\*\* (see derating diagrams L78)

 suitable for battery charging (see details page 19)

**60 W High efficiency, low profile  
Modular DC Power Supplies for electrical  
cabinets**

**Type 78.50**

- Output 12 V DC, 50 W
- Designed for SELV system (EN 60950)
- Suitable for backup battery systems

**Type 78.60**

- Output 24 V DC, 60 W
- Designed for SELV system (EN 60950)
- Suitable for backup battery systems

- High efficiency (up to 91%)
- Low (< 0.3 W) stand-by power consumption
- Thermal protection: internal, with  $V_{out}$  shutdown - power OFF to reset
- Short circuit protection: Hiccup (auto-recovery) mode
- Overvoltage protection: Varistor
- Flyback topology
- ZVS (Zero-voltage-switching), quasi-resonant mode switching
- Compliant with EN 60950-1 and EN 61204-3
- Parallel working for automatic redundancy - with OR diodes
- Dual Polarity and Series connection permissible
- Compact dimensions: 70 mm (4-modules) wide, 61 mm deep
- 35 mm rail (EN 60715) mount

Screw terminal



For outline drawing see page 26

**78.50**

- 12 V DC, 50 W output
- Output adjustable between 12-16 V
- ZVS technology
- SELV

**78.60**

- 24 V DC, 60 W output
- Output adjustable between 24-28 V
- SELV
- Suitable for battery charging
- ZVS technology

\* (see diagrams P78)  
 \*\* peak to peak, 100 Hz component, with 100 V AC input  
 \*\*\* 88...100 V AC with output current limited to 80%  $I_N$   
 \*\*\*\* (see derating diagrams L78)  
 suitable for battery charging (see details page 19)

Output specification		78.50	78.60
Output current (-20...+40 °C, 230 V AC input)	A	4.6	2.8
Rated current $I_N$			
50 °C, input (100...265)V AC - (140...370)V DC	A	4.2	2.5
Rated voltage	V	12	24
Rated power	W	50	60
Output power (-20...+40 °C, 230 V AC input)	W	55	68
Peak current capability for 3 ms*	A	12	10
Output voltage adjust	V	12...16	24...28
Voltage variation (from no-load to full-load)		< 1%	< 1%
Voltage ripple @ full load**	mV	< 200	< 200
Hold-up time @ full load: with 100 V AC input	ms	> 30	> 20
with 260 V AC input	ms	> 150	> 130
Input specification		78.50	78.60
Nominal voltage ( $U_N$ )	V AC (50/60 Hz)	110...240	110...240
	V DC (not polarized)	220	220
Operating range	V AC (50/60 Hz)	88...265***	88...265***
	V DC	140...370	140...370
Max power consumption (@ 100 V AC, 50 Hz)	VA	86	105
	W	57	68
Stand-by power consumption	W	< 0.3	< 0.45
Power factor		0.65	0.65
Max current consumption (@ 88 V AC)	A	0.7	0.9
Max. inrush current (peak @ 265 V) for 3 ms	A	30	30
Input fuse		1.6 A - T	1.6 A - T
Technical data		78.50	78.60
Efficiency (@ 230 V AC)	%	90	91
MTTF	h	> 400 · 10 <sup>3</sup>	> 500 · 10 <sup>3</sup>
Start-up delay	s	< 1	< 1
Dielectric strength between input/output	V AC	3000	3000
Dielectric strength between input/PE	V AC	1500	1500
Ambient temperature range****	°C	-20...+70	-20...+70
Protection category		IP 20	IP 20
<b>Approvals</b> (according to type)			



**Industrial Switch Mode DC Power Supplies:  
110 W to 130 W**

**Type 78.1A**

- Output 24 V DC, 120 W

**Type 78.1B**

- Output 24 V DC, 110 W, compact size
- Secure electrical separation (SELV according to EN 60950)

**Type 78.1D**

- Output 24 V DC, 130 W
- Double stage active Power Factor Correction

- Fold-Back overload characteristics for Battery charging applications and parallel working for increased load current (78.1D)
- High efficiency (up to 93%)
- Low stand-by power consumption (down to 1 W)
- LLC (78.1B) or forward topology (78.1D)
- Thermal protection: internal with pre-alert alarm via LED and auxiliary contact, and with V<sub>out</sub> safety shutdown - power OFF to reset (78.1D)
- Overload indication: Pre-alert alarm via LED and auxiliary contact indication (78.1D)
- Boost current: Without time limit, with LED and auxiliary contact indication (78.1D)
- Overload protection: Fold-back mode (78.1D)
- Short circuit protection: Hiccup (auto-recovery) mode
- Input fuse: Easily replaceable plus spare
- Overvoltage protection: Varistor
- Compliant with EN 60950-1 and EN 61204-3
- Parallel working for increased load current (with OR diodes)
- Dual Polarity and Series connection permissible
- 35 mm rail (EN 60715) mount

**78.1A**



- 24 V DC, 120 W output
- Output adjustable between 24-28 V

**78.1B**



- 24 V DC, 110 W output
- Output adjustable between 24-28 V
- Compact size, low stand-by consumption

**78.1D**



- 24 V DC, 130 W output
- Output adjustable between 24-28 V
- Double stage with active PFC (Power Factor Correction)

Replaceable fuse + spare



Thermal protection with LED indication



(depending on type)

Auxiliary contact signalling



- \* (see diagrams P78)
- \*\* peak to peak, 100 Hz component, with 120 V AC input (see derating diagrams L78)
- \*\*\* suitable for battery charging (see details page 19)

For outline drawing see page 26, 27, 28

**Output specification**

Output current (-20...+50 °C, 230 V AC input)	A	6.0 (@40 °C)	5.0 (@40 °C)	5.4 (@50 °C)
Output current (-20...+50 °C, 120 V AC input)	A	4.5 (@40 °C)	4.5 (@40 °C)	5.4 (@50 °C)
Rated voltage	V	24	24	24
Rated power	W	120 (@40°C)	110 (@40°C)	130 (@50°C)
Max. output power (-20...+40 °C, 230 V AC input)	W	140	120	130
Peak current capability for 5 ms*	A	10	10	10
Output voltage adjust	V DC	24...28	24...28	24...28
Voltage variation (from no-load to full-load)		< 2%	< 3%	< 1%
Voltage ripple @ full load**	mV	< 500	< 300	< 100
Hold-up time @ full load:	with 120 V AC input ms	> 25	> 20	> 20
	with 250 V AC input ms	> 110	> 90	> 20

**Input specification**

Nominal voltage (U <sub>N</sub> )	V AC (50/60 Hz)	120...240	120...240	110...240
	V DC	—	220	110...240
Operating range	V AC (50/60 Hz)	120...250	100...265	88...265
	V DC	—	140...275 (polarized)	95...275 (non-polarized)
Drop out DC Voltage	V	—	110	80
Max power consumption (@ minimum V AC operating range)	VA	195 (@50 Hz)	268 (@50 Hz)	145 (@50 Hz)
	W	134 (@50 Hz)	133 (@50 Hz)	145 (@50 Hz)
Stand-by power consumption	W	< 1.9	< 1.0	< 3.3
Power factor		0.69	0.5	0.998
Max current consumption	A	1.75 (@120 V AC)	1.75 (@115 V AC)	1.6 (@88 V AC)
Max. inrush current (peak @ 250 V) for 3 ms	A	13	12	12
Replaceable input fuse		—	3.15 A - T	2.5 A - T

**Technical data**

Efficiency (@ 230 V AC)	%	92	93	89
MTTF	h	> 500 · 10 <sup>3</sup>	> 500 · 10 <sup>3</sup>	> 400 · 10 <sup>3</sup>
Start-up delay	s	< 3	< 1	< 1
Dielectric strength between input/output	V AC	2000	2500 (SELV)	2500
Dielectric strength between input/PE	V AC	—	1500	1500
Ambient temperature range***	°C	-20...+60	-20...+70	-20...+70
Protection category		IP 20	IP 20	IP 20

**Approvals (according to type)**





**Industrial Switch Mode DC Power Supply:  
240 W**

**High efficiency PSU with high peak output  
current and low stand by power consumption**

**Type 78.2A**

- Output 24 V DC, 240 W

- High efficiency (up to 94%)
- Low stand-by power consumption
- LLC topology
- Thermal protection internal, power OFF to reset
- Boost current: Without time limit
- Short circuit protection: Hiccup (auto-recovery) mode
- Overvoltage protection: Varistor
- Compliant with EN 61204-3
- Parallel working for increased load current (with OR diodes)
- Dual Polarity and Series connection permissible
- 35 mm rail (EN 60715) mount

Screw terminal



For outline drawing see page 28

**Output specification**

Output current (-20...+40 °C, 230 V AC input)	A	11 (@30°C) / 10 (@40°C)
Output current (-20...+40 °C, 120 V AC input)	A	9
Rated voltage	V	24
Rated power	W	240 (@40°C)
Max. output power (-20...+30 °C, 230 V AC input)	W	260
Peak current capability for 5 ms*	A	25
Output voltage adjust	V DC	24...28
Voltage variation (from no-load to full-load)		< 3%
Voltage ripple @ full load**	mV	< 300
Hold-up time @ full load: with 100 V AC input ms		> 30
	with 250 V AC input ms	> 50

**Input specification**

Nominal voltage (U <sub>N</sub> )	V AC (50/60 Hz)	120 or 230
Operating range	V AC (50/60 Hz)	95...130 or 185...250
Drop out DC Voltage	V	—
Max power consumption	VA	361 (@ 50 Hz)
(@ minimum V AC operating range)	W	265 (@ 50 Hz)
Stand-by power consumption	W	≤ 3 @ 120 V ; ≤ 2.6 W @ 230 V
Power factor		0.73
Max current consumption	A	3.5 (@ 100 V AC)
Max. inrush current (peak @ 265 V) for 3 ms	A	14
Replaceable input fuse		—

**Technical data**

Efficiency (@ 230 V AC)	%	94
MTTF	h	> 400 · 10 <sup>3</sup>
Start-up delay	s	< 1
Dielectric strength between input/output	V AC	2000
Dielectric strength between input/PE	V AC	—
Ambient temperature range***	°C	-20...+60
Protection category		IP 20

**Approvals** (according to type)



**78.2A**



- 24 V DC, 240 W output
- Output adjustable between 24-28 V

- \* (see diagrams P78)
- \*\* peak to peak, 100 Hz component, with 100 V AC input
- \*\*\* (see derating diagrams L78)
- suitable for battery charging (see details page 19)

**Industrial Switch Mode DC Power Supply:  
240 W****Overload characteristics support parallel  
working for increased load current****Type 78.2E**

- Output 24 V DC, 240 W
- Double stage active Power Factor Correction
- High efficiency (up to 93%)
- Low stand-by power consumption
- Forward topology
- Thermal protection: internal with pre-alert alarm via LED and auxiliary contact, and with  $V_{out}$  safety shutdown - power OFF to reset
- Overload indication: Pre-alert alarm via LED and auxiliary contact indication
- Boost current: Without time limit, with LED and auxiliary contact indication
- Overload up to 20 A
- Short circuit protection: Hiccup (auto-recovery) mode
- Input fuse: Easily replaceable plus spare
- Overvoltage protection: Varistor
- Compliant with EN 60950-1 and 61204-3
- Parallel working for increased load current (with OR diodes)
- Dual Polarity and Series connection permissible
- 35 mm rail (EN 60715) mount

Screw terminal



F

For outline drawing see page 27

**Output specification**

Output current (-20...+40 °C, 230 V AC input)	A	10.8
Rated current $I_N$ (50 °C, full input operating range)	A	10
Rated voltage	V	24
Rated power	W	240
Output power (-20...+40 °C, 230 V AC input)	W	250
Peak current capability for 5 ms*	A	25
Output voltage adjust	V DC	24...28
Voltage variation (from no-load to full-load)		< 1%
Voltage ripple @ full load**	mV	< 100
Hold-up time @ full load: with 110 V AC input ms		> 20
with 260 V AC input ms		> 20

**Input specification**

Nominal voltage ( $U_N$ )	V AC (50/60 Hz)	110...240
	V DC	110...240
Operating range	V AC (50/60 Hz)	88...265
	V DC	90...275 (non-polarised)
Drop out DC Voltage	V	80
Max power consumption (@ minimum V AC operating range)	VA	275 (@ 50 Hz)
	W	274 (@ 50 Hz)
Stand-by power consumption (@ 88 V)	W	≤ 2.8
Power factor		0.995
Max current consumption	A	3.0 (@ 88 V AC)
Max. inrush current (peak @ 265 V) for 3 ms	A	12
Replaceable input fuse		3.15 A - T

**Technical data**

Efficiency (@ 230 V AC)	%	93
MTTF	h	> 400 · 10 <sup>3</sup>
Start-up delay	s	< 1
Dielectric strength between input/output	V AC	2500
Dielectric strength between input/PE	V AC	1500
Ambient temperature range***	°C	-20...+70
Protection category		IP 20

**Approvals** (according to type)**78.2E**

- 24 V DC, 240 W output
- Output adjustable between 24-28 V
- Double stage with active PFC (Power Factor Correction)

Replaceable fuse  
+ spareThermal protection  
with LED indicationAuxiliary contact  
signalling

\* (see diagrams P78)

\*\* peak to peak, 100 Hz component, with 110 V AC input

\*\*\* (see derating diagrams L78)

**KNX power supply with 30 V DC output - 640 mA**

- Output 30 V DC 640 mA, KNX Bus
- Diagnostic LEDs
- 72 mm wide (4 modules)
- 35 mm rail (EN 60715) mount
- Suitable for ETS 4 (or latest versions)

78.2K  
Screw terminal



**78.2K.1.230.3000**



- Thermal protection, overload protection and short-circuit protection
- Two power supplies can be installed 15 meters apart

For outline drawing see page 29

Output specification		
Output current	mA	640
Output voltage	V	30
Input specification		
Nominal voltage (U <sub>N</sub> )	V AC	230...240
Operating range	V AC	185 - 260
Stand-by power consumption	W	1.45
Power factor		0.62
Max current consumption	A	0.25
Technical data		
Minimum distance between power supplies	m	15
Dielectric strength between input/output	V AC	3000
Ambient temperature range	°C	-5/+45
Protection category		IP 20
<b>Approvals</b> (according to type)		<b>CE UK CA</b>

F

## Ordering information

Example: 78 series switch mode power supply, 36 W - 24 V DC output, supply voltage 110...240 V AC, embedded fuse and output voltage regulator.

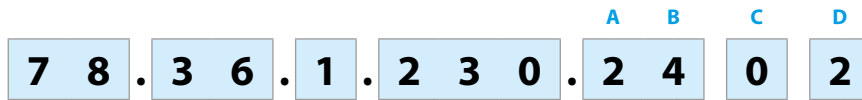

### Series

### Power

12 = 12 W output  
 25 = 25 W output  
 36 = 36 W output  
 50 = 50 W output  
 60 = 60 W output  
 1A = 120 W output  
 2A = 240 W output  
 1B = 110 W output  
 1D = 130 W output  
 2E = 240 W output  
 2K = KNX 640 mA

### Voltage conversion

1 = AC/DC input, DC output  
 1 = AC input, DC output (78.1A, 78.2A, 78.2K)

### Input voltage

230 = 110...240 V AC / 220V DC  
 230 = 110...240 V AC/DC  
 230 = 120...240 V AC / 220V DC  
 230 = 230...240 V AC (78.2K)  
 230 = 120 or 230 V AC adjustable (78.2A)

### D:

0 = Standard  
 2 = Embedded fuse + output voltage regulator (without output voltage regulator for 78.12)  
 3 = Replaceable fuse + output voltage regulator  
 4 = Fuse + regulator + positive logic contact  
 5 = Fuse + regulator + pre-alarm contact

### C:

0 = Standard  
 1 = Double stage, with PFC (Power Factor Correction)  
 8 = Power supply for OPTA PLR, 8A series

### AB:

12 = 12 V output  
 24 = 24 V output  
 30 = 30 V output KNX

### Codes

78.12.1.230.1200  
 78.12.1.230.2400  
 78.12.1.230.2402  
 78.12.1.230.2482  
 78.25.1.230.1200  
 78.25.1.230.2400  
 78.36.1.230.2402  
 78.36.1.230.1202  
 78.50.1.230.1202  
 78.60.1.230.2402  
 78.1A.1.230.2402  
 78.2A.1.230.2402  
 78.1B.1.230.2403  
 78.1D.1.230.2414  
 78.1D.1.230.2415  
 78.2E.1.230.2414  
 78.2E.1.230.2415  
 78.2K.1.230.3000

## Technical data

EMC specifications (according to EN 61204-3)		Reference standard	78.12, 78.25, 78.36	78.50, 78.60	78.1A	78.1B	78.1D	78.2A	78.2E
Electrostatic discharge	contact discharge	EN 61000-4-2	4 kV	4 kV	4 kV	4 kV	4 kV	4 kV	4 kV
	air discharge	EN 61000-4-2	8 kV	8 kV	8 kV	8 kV	8 kV	8 kV	8 kV
Radiated electromagnetic field	80...1000 MHz	EN 61000-4-3	6 V/m	10 V/m	10 V/m	10 V/m	10 V/m	10 V/m	10 V/m
	1...2.8 GHz	EN 61000-4-3	3 V/m	3 V/m	3 V/m	3 V/m	3 V/m	10 V/m	10 V/m
Fast transients (burst 5/50 ns, 5 and 100 kHz)	on supply terminals	EN 61000-4-4	2 kV	3 kV	2 kV	2 kV	3 kV	3 kV	3 kV
	Voltage pulses on supply terminals (surge 1.2/50 µs)	common mode	EN 61000-4-5	—	—	2 kV	2 kV	3 kV	2.5 kV
differential mode		EN 61000-4-5	2 kV	2 kV	4 kV *	4 kV *	4 kV*	4 kV	4 kV*
Radio-frequency common mode voltage (0.15...230 MHz)	on supply terminals	EN 61000-4-6	6 V	10 V	10 V	10 V	10 V	10 V	10 V
Short interruptions		EN 61000-4-11	5 cycles	6 cycles	5 cycles	5 cycles	6 cycles	5 cycles	5 cycles
Radio-frequency conducted emissions	0.15...30 MHz	EN 55022	class B	class B	class A	class B	class B	class A	class B
Radiated emissions	30...1000 MHz	EN 55022	class B	class B	class A	class A	class A	class A	class A
<b>Terminals</b>			<b>Max</b>			<b>Min...Max</b>			
Wire size (Solid cable, stranded cable)		mm <sup>2</sup>	1 x 4 / 2 x 2.5			1 x 0.5...1 x 4			
		AWG	1 x 12 / 2 x 14			1 x 20...1 x 12			
Wire size (Solid cable, stranded cable for 78.50, 78.60, 78.1A and 78.2A)		mm <sup>2</sup>	1 x 2.5			1 x 0.5...2.5			
		AWG	1 x 14			1 x 20...14			
Screw torque		Nm	0.8			0.5			
		Lb-in	7.1			7.1			
Wire strip length		mm	8			8			
<b>Other data</b>									
Power lost to the environment with rated output current		W	2 (78.12), 2.3 (78.25), 3.6 (78.36, 78.50), 5.4 (78.60)						
		W	10 (78.1A), 9 (78.1B), 13.2 (78.1D), 15.3 (78.2A), 16.8 (78.2E)						

\* input fuse may blow for surges higher than 2 kV

## Technical data for 78.2K

EMC specifications (according to EN 61204-3)		Reference standard	78.2K
Electrostatic discharge	contact discharge	EN 61000-4-2	4 kV
	air discharge	EN 61000-4-2	8 kV
Radiated electromagnetic field	80...1000 MHz	EN 61000-4-3	10 V/m
	1...2.8 GHz	EN 61000-4-3	3 V/m
Fast transients (burst 5/50 ns, 5 and 100 kHz)	HBES terminals	EN 61000-4-4	1 kV
	on supply terminals	EN 61000-4-4	2 kV
Voltage pulses on supply terminals (surge 1.2/50 µs)	DM supply terminals	EN 61000-4-5	1 kV
	CM supply terminals	EN 61000-4-5	2 kV
	HBES terminals	EN 61000-4-5	2 kV
Radio-frequency common mode voltage (0.15...230 MHz)	HBES terminals	EN 61000-4-6	10 V
	on supply terminals	EN 61000-4-6	10 V
Short interruptions	criterion A	EN 61000-4-11	10 cycles
Radio-frequency conducted emissions	0.15...30 MHz	EN 55022	class B
Radiated emissions	30...1000 MHz	EN 55022	class B
<b>Terminals</b>			<b>Max</b>
Wire size (Solid cable, stranded cable)		mm <sup>2</sup>	1 x 4 / 2 x 2.5
		AWG	1 x 12 / 2 x 14
Screw torque		Nm	0.8
Wire strip length		mm	9
<b>Other data</b>			
Power lost to the environment with rated output current		W	4.8

DM: differential mode  
CM: common mode

Output specification

L78-1 Output current v ambient temperature (78.12)

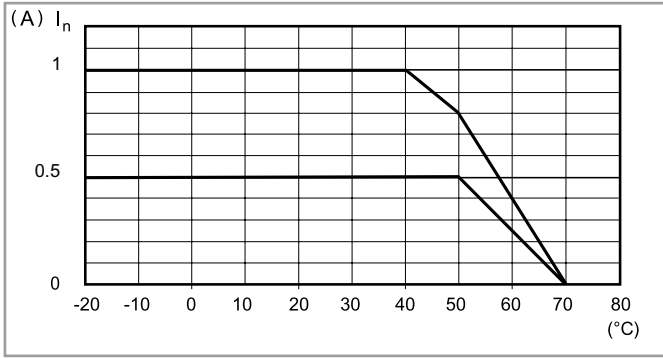

P78-1 Output peak current v time (78.12)

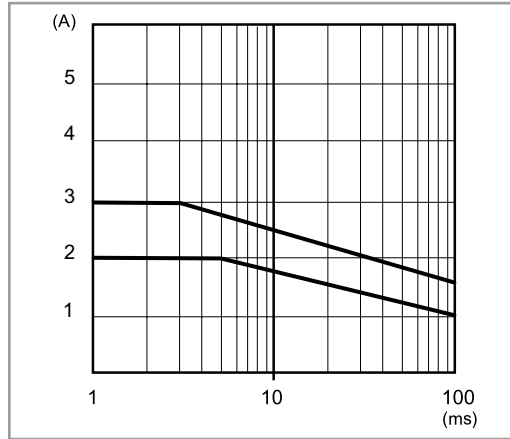

L78-2 Output current v ambient temperature (78.25)

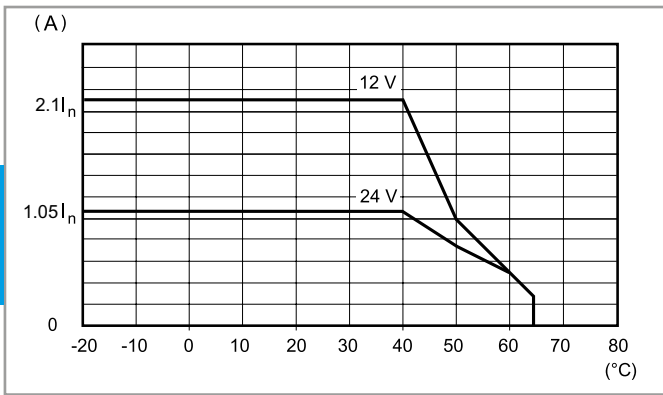

P78-2 Output peak current v time (78.25)

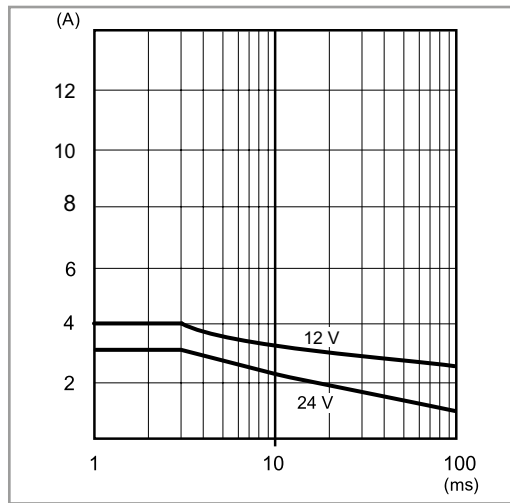

L78-3 Output current v ambient temperature (78.36) - 12 V

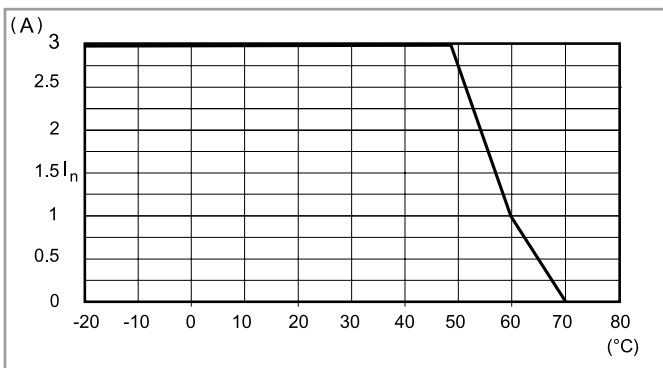

P78-3 Output peak current v time (78.36) - 12 V

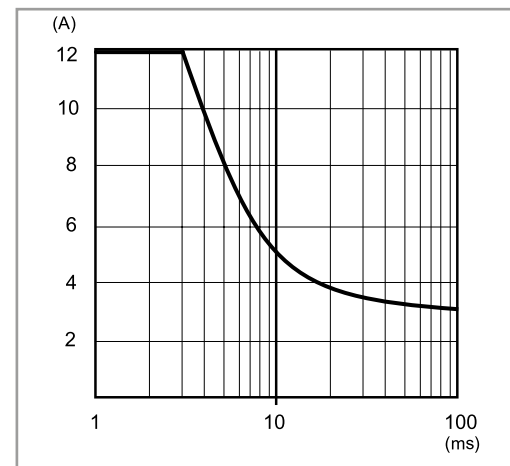

F

### Output specification

**L78-3 Output current v ambient temperature (78.36) - 24 V**

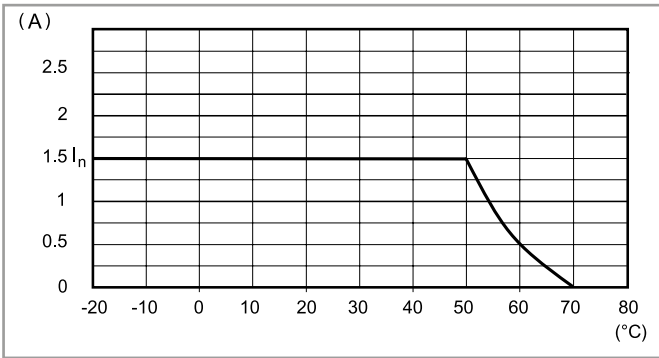

**P78-3 Output peak current v time (78.36) - 24 V**

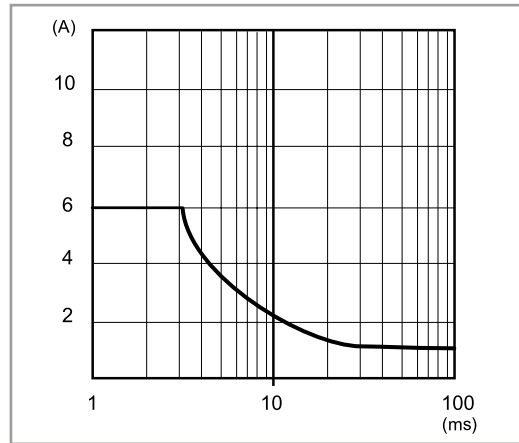

**L78-4 Output current v ambient temperature (78.60)**

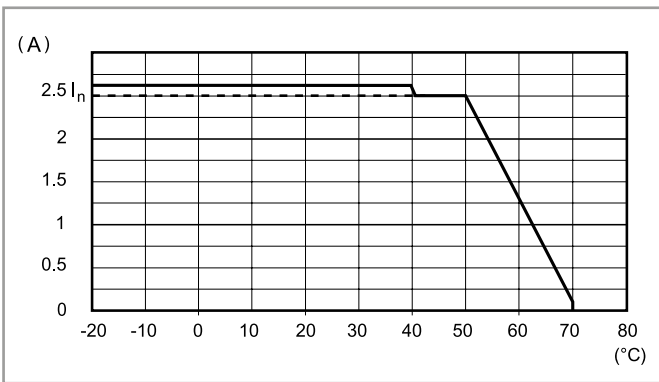

**P78-4 Output peak current v time (78.60)**

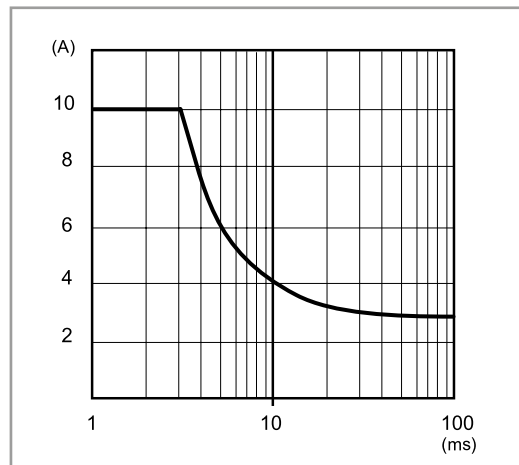

**L78-5 Output current v ambient temperature (78.50)**

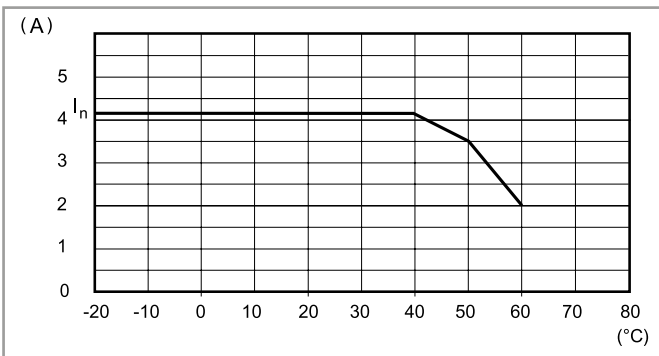

**P78-5 Output peak current v time (78.50)**

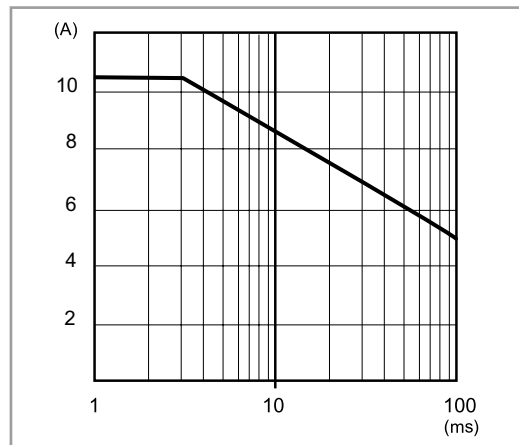

F

### Output specification

L78-7 Output current v ambient temperature (78.1A)

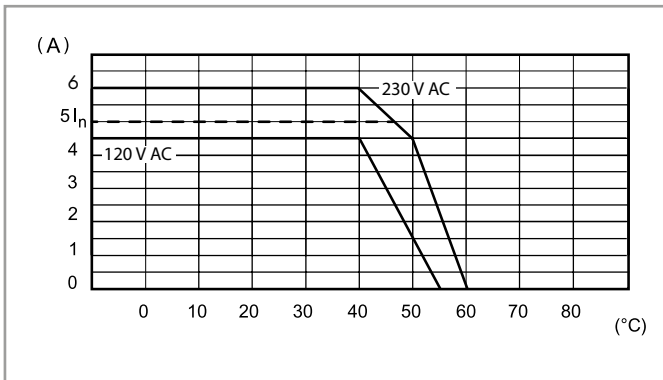

P78-7 Output peak current v time (78.1A)

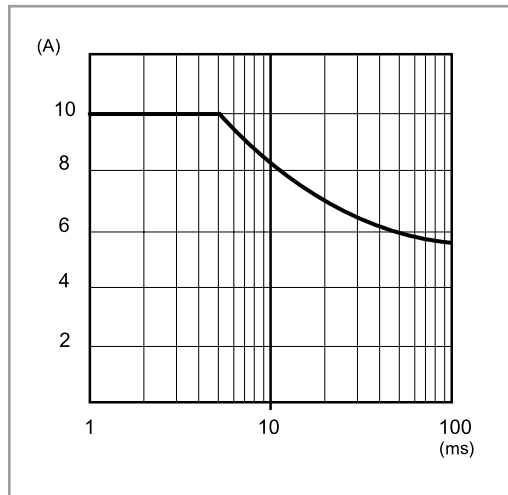

L78-8 Output current v ambient temperature (78.1B)

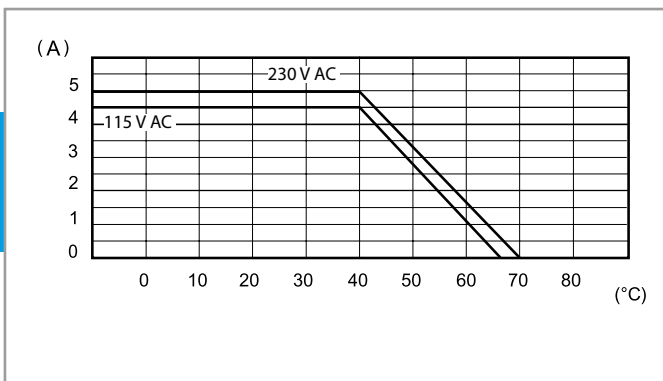

P78-8 Output peak current v time (78.1B)

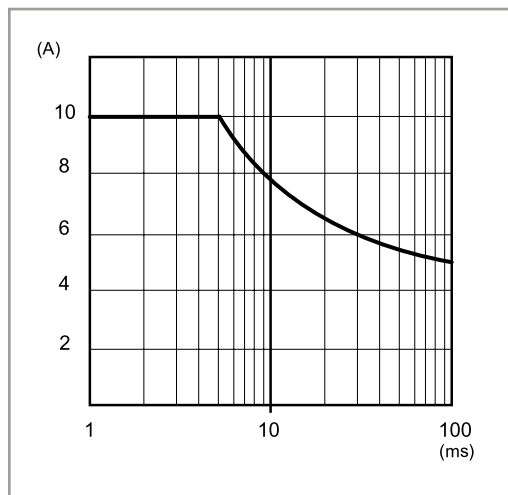

L78-9 Output current v ambient temperature (78.1D)

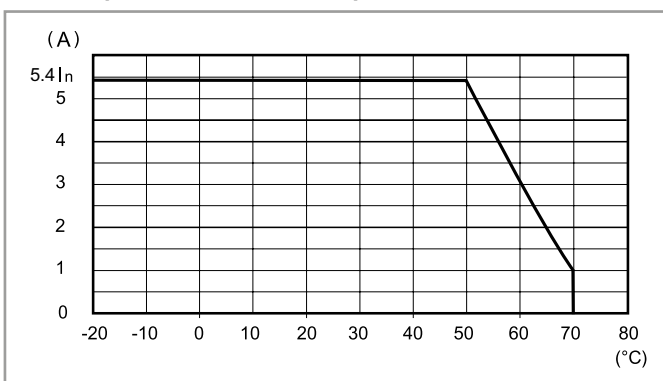

P78-9 Output peak current v time (78.1D)

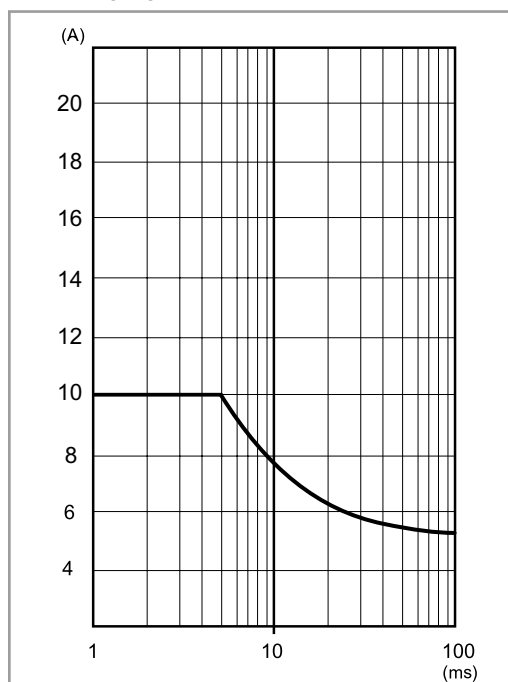



### Output specification

**L78-10 Output current v ambient temperature (78.2A)**

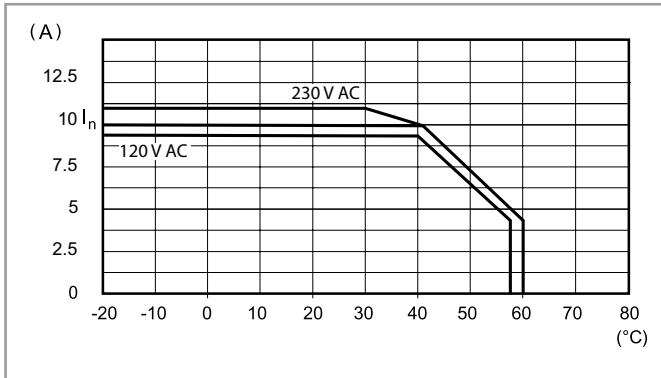

**P78-10 Output peak current v time (78.2A)**

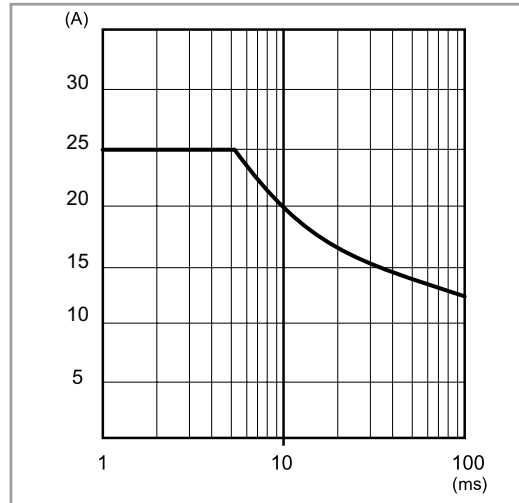

**L78-11 Output current v ambient temperature (78.2E)**

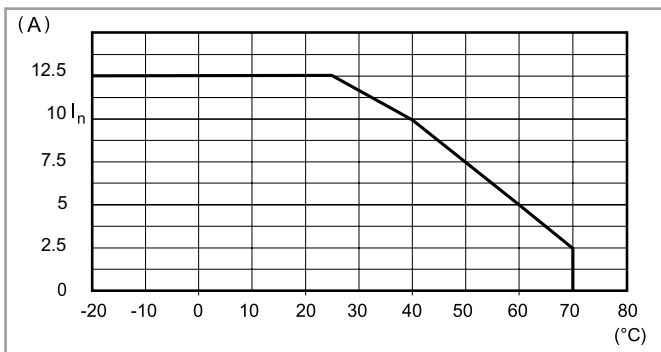

**P78-11 Output peak current v time (78.2E)**

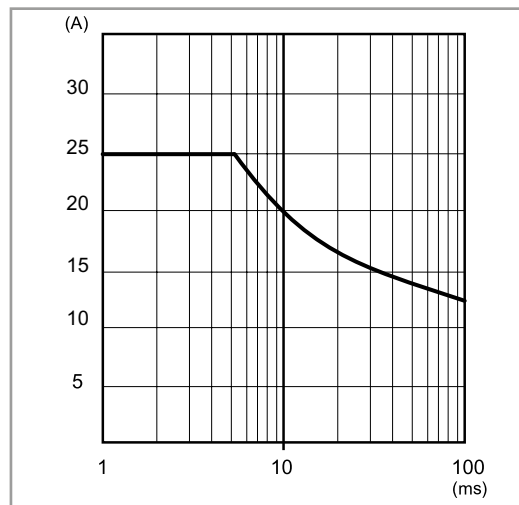

F

## Output specification

### FB78-5 Output voltage v output current (78.2E)

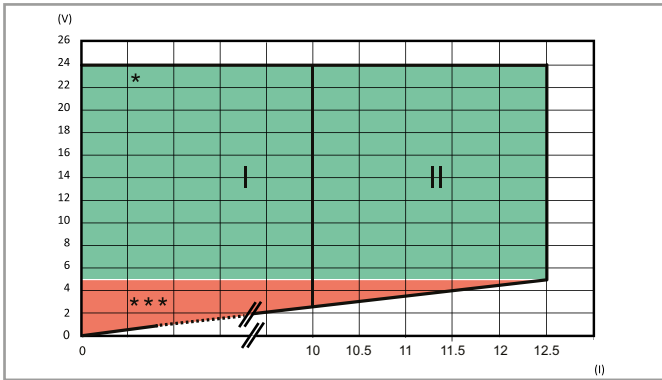

I: Output characteristic for temperature up to 50 °C

II: Output characteristic for temperature up to 25 °C

\* / \*\*\*: See LED table below

### FB78-6 Output voltage v output current (78.2K)

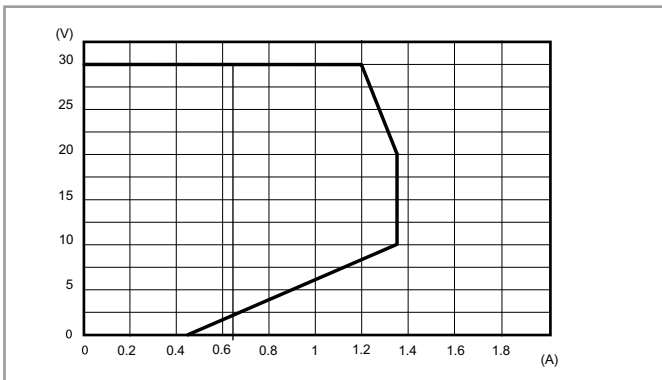

Overload diagram, KNX approved

## Hiccup mode

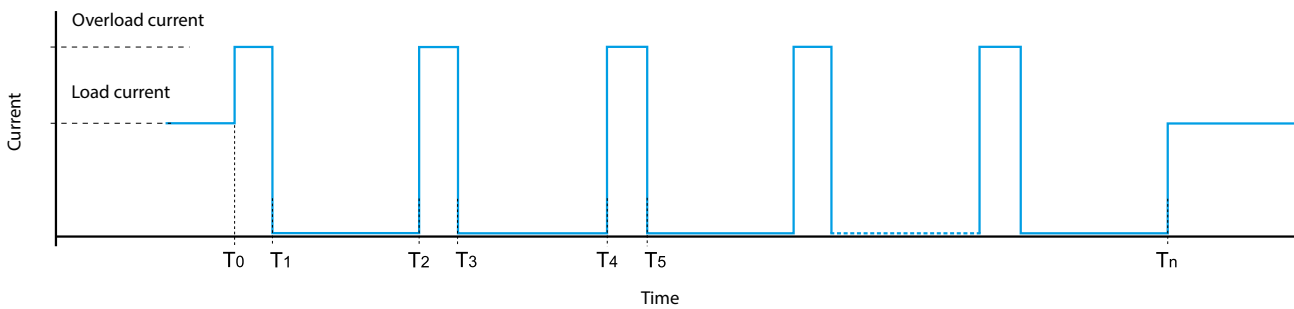

Under normal conditions, the 78 Series Power Supply supplies the current required by the load.

However, under abnormal conditions such as a short circuit or heavy overload ( $T_0$ ) the output voltage will be rapidly reduced to zero - followed by the current ( $T_1$ ). After approximately 2 seconds ( $T_1$  to  $T_2$ ), the power supply checks for the persistence of the anomaly over the time period  $T_2$  to  $T_3$  (30 to 100ms - dependent on the type of anomaly). If the anomaly persists, as shown above, the current is again reset to 0 A for a further 2 s ( $T_3$  to  $T_4$ ). This "hiccup" process is repeated until the anomaly is removed ( $T_n$ ), whereon the power supply then returns to normal working.

78.1B is able to handle this anomaly for 15 s. After this time it enters in protection mode, and a manual reset is necessary by removing and re-applying the supply voltage

## Fold-back technology and battery charging

**Fold-back technology** allows load current to be maintained under conditions of heavy overload. In case of heavy overload, the fold-back circuit will provide the output current and the output voltage, in accordance with the relevant "FB" diagram. In practice, when overcurrent is drawn by the load, the fold-back circuit reduces the output voltage supplying the current up to the maximal value, then it starts to work in hiccup mode. Also in case of short circuit, the power supply will work in hiccup mode. Both these conditions end when the anomaly is removed, and the power supply returns to normal working.

The fold-back mode allows the use of the power supply as a **battery charger**, in particular 78.36/50/60 for charging lead acid batteries (both standard and gel types) rated 7...24 Ah and 78.1D for charging lead batteries rated 17...38 Ah. In any case, it is necessary to verify that the charging characteristics of the batteries are compliant with the output characteristics of the power supply.

It is suggested to insert a diode in series between the + output and the + input of the battery (if not already installed in the battery unit).

### Back-up connection for mains interruption

When the mains is ON, the power supply is able to charge the battery and supply the load at the same time (the power supply must be rated minimum 110 % of the load). When the mains is OFF, the battery starts to supply the load.

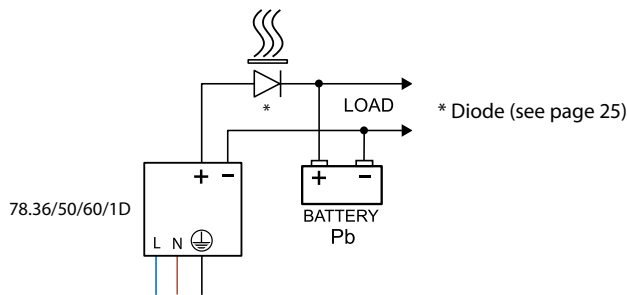

FB78-1 Output voltage v output current (78.50)

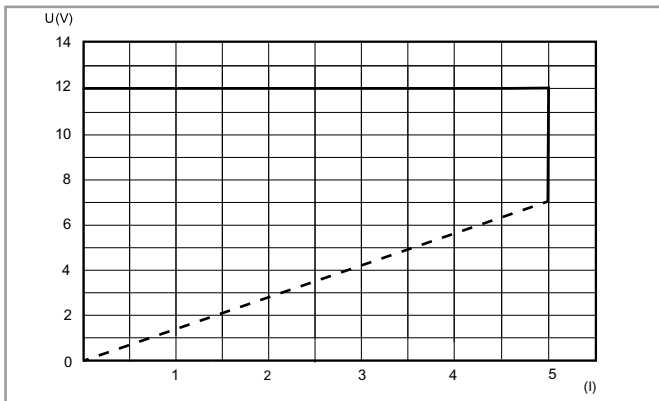

FB78-2 Output voltage v output current (78.60)

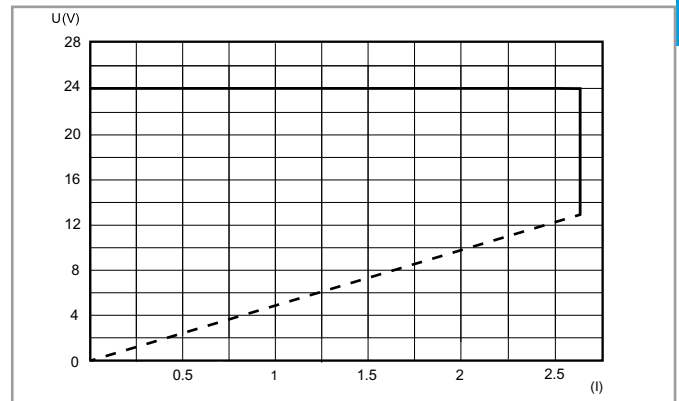

FB78-3 Output voltage v output current (78.1D)

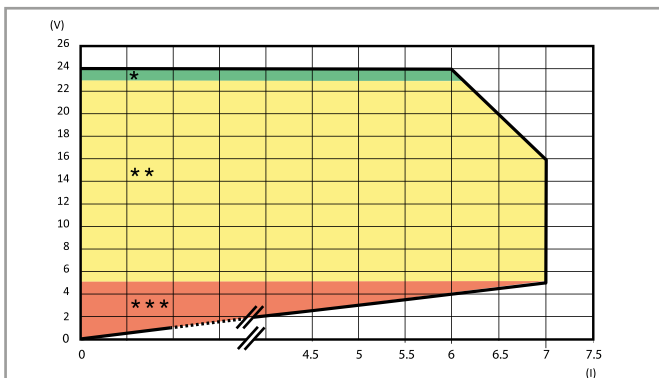

Fold-back characteristic for ambient temperature up to 50 °C

\* / \*\* / \*\*\*: See LED table below

**78.1D, 78.2E LED table**

**Feedback contact switching mode: Type 78.xx.x.xxx.24x4 ("positive logic")**

The NO contact closes when power is applied to the unit and remains closed unless there is a serious fault preventing the power supply unit from delivering output current. (Such as a broken fuse, power supply failure, short-circuit or thermal protection.)

This version is suitable, for example, for signalling to a remote PLC all those alarms representing a service interruption of the power supply output.

Type	Area	State	LED	Contact 13-14
78.1D.1.230.2414 78.2E.1.230.2414	*	OK	DC OK ALARM   OFF	
	**	Overload (78.1D only)	DC OK ALARM   OFF	
	***	Short circuit	DC OK ALARM   OFF	
		Thermal limit	DC OK ALARM	
		Thermal protection <sup>#</sup>	DC OK  OFF ALARM	

<sup>#</sup>Remove the supply voltage, following the intervention of the thermal protection, in order to reset the power supply.

**78.1D, 78.2E LED table**

**Feedback contact switching mode: Type 78.xx.x.xxx.24x5 ("pre-alarm")**

The NO contact closes when an anomaly happens (Overload, short circuit, thermal limit, thermal protection).

This version is suitable, for example, for activating visual or audible alarms, or to activate a cooling fan.











Type	Area	State	LED	Contact 13-14
78.1D.1.230.2415 78.2E.1.230.2415	*	OK	DC OK ALARM   OFF	
	**	Overload (78.1D only)	DC OK ALARM   OFF	
	***	Short circuit	DC OK ALARM   OFF	
		Thermal limit	DC OK ALARM	
		Thermal protection <sup>#</sup>	DC OK  OFF ALARM	

<sup>#</sup>Remove the supply voltage, following the intervention of the thermal protection, in order to reset the power supply.

**78.12, 78.25, 78.36, 78.50, 78.60, 78.1A, 78.2A, 78.1B LED table**

Type	State	LED
78.12.1.230.xx00 78.25.1.230.1200 78.25.1.230.2400 78.36.1.230.2402 78.50.1.230.1202 78.60.1.230.2402 78.1A.1.230.2402	OK	
	Short circuit	
	Thermal limit	OFF
78.2A.1.230.2402 78.1B.1.230.2403	OK	
	Short circuit	 15s OFF
	Thermal limit	OFF

LED table

Type	Area	State	LED	OUTPUT
78.2K.1.230.3000	CHECK START UP	$V_{out}$ OK	 • OFF • OFF	ON
		$V_{out}$ LOW < 29V	 • OFF • OFF	OFF
		$V_{out}$ HIGH > 33V	• OFF  • OFF	OFF
	NORMAL FUNCTION	$V_{out}$ OK $I_{out}$ > 0.9A	 • OFF 	ON
		$V_{out}$ < 29V $I_{out}$ > 0.9A	• OFF • OFF 	ON
	 Alarm condition: $T_{amb} > 45^{\circ}\text{C}$ @ $I_{nom}$ .	Pre-alarm: up to 60s	 • OFF 	ON
		Latched alarm	• OFF • OFF 	OFF

F

Wiring diagrams for 78.12, 78.25, 78.36, 78.50, 78.60

Basic connections

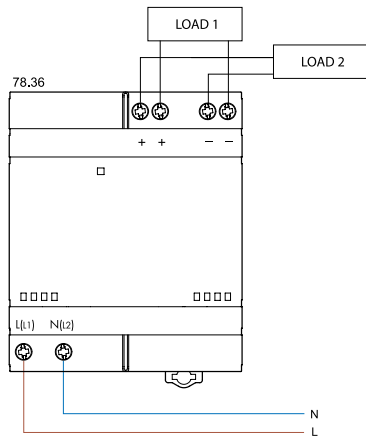
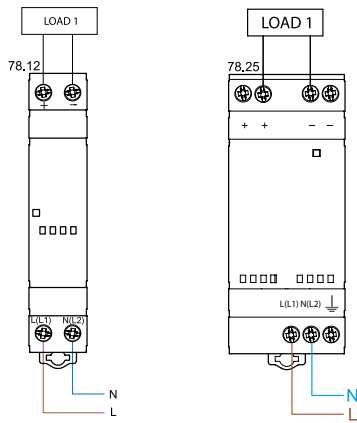

Basic connections

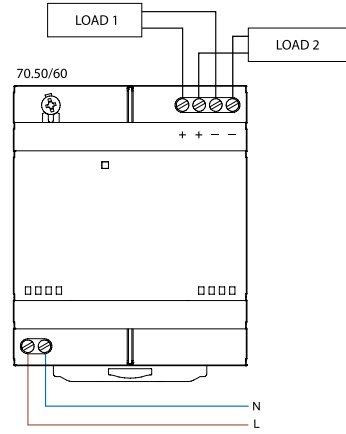

Dual polarity connection

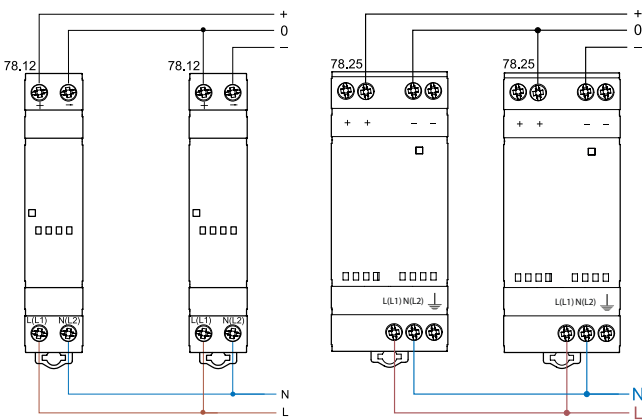

Dual polarity connection

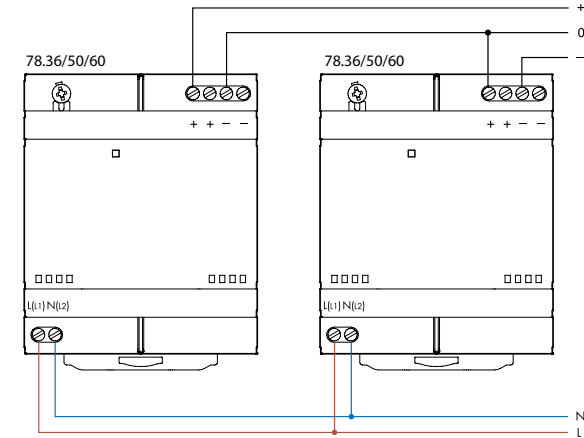

Series connection

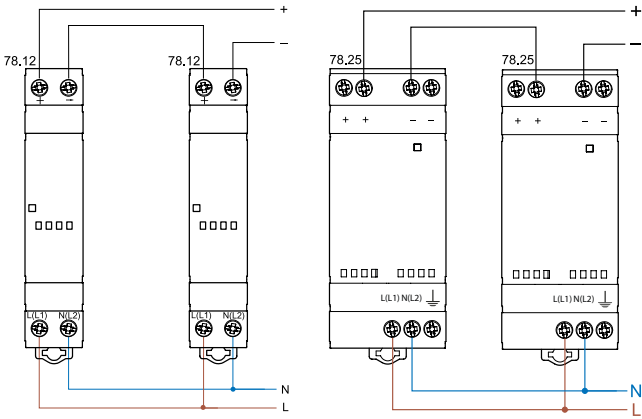

Series connection

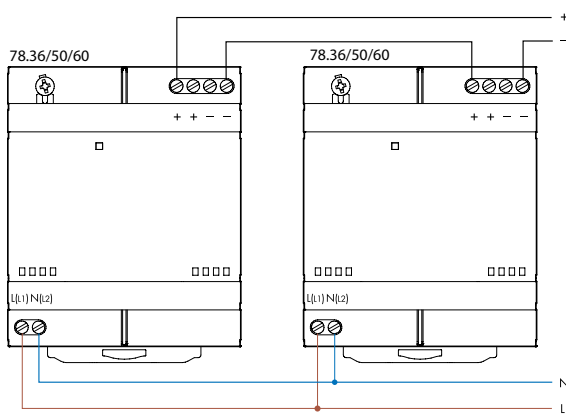

Parallel connection (78.50/60 only)

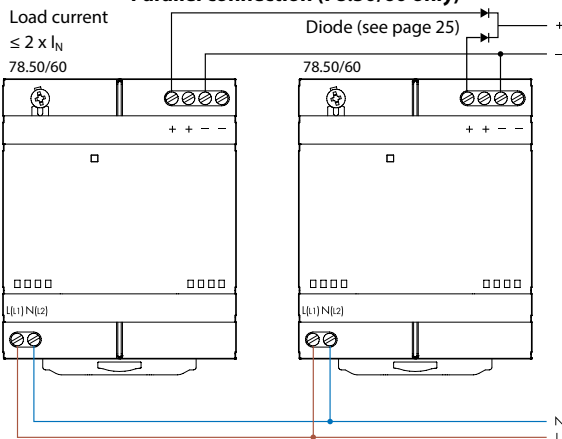

Manual redundancy

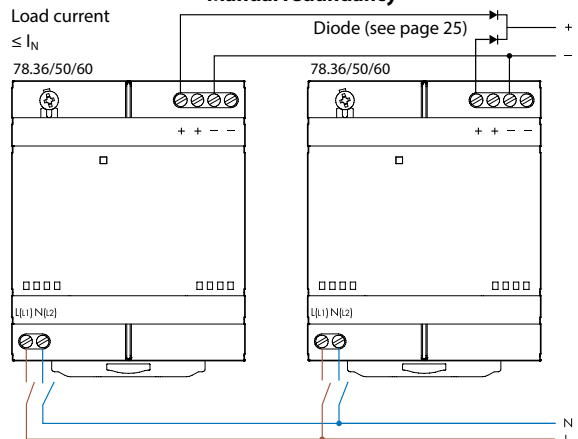

### Wiring diagrams for 78.12 OPTA

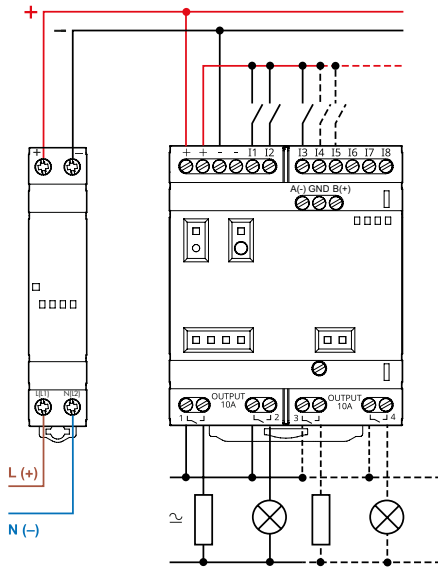

### Wiring diagrams for 78.1B & 78.1D

#### Basic connections

78.1B - Power supply connection

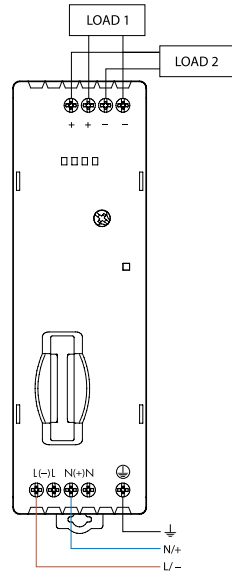

78.1D - Power supply connection

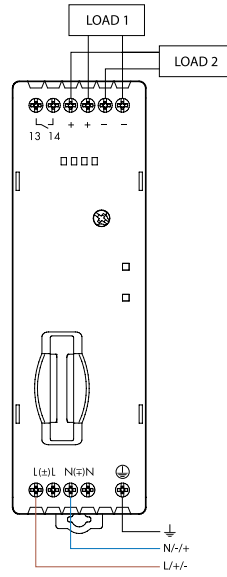

Dual polarity connection

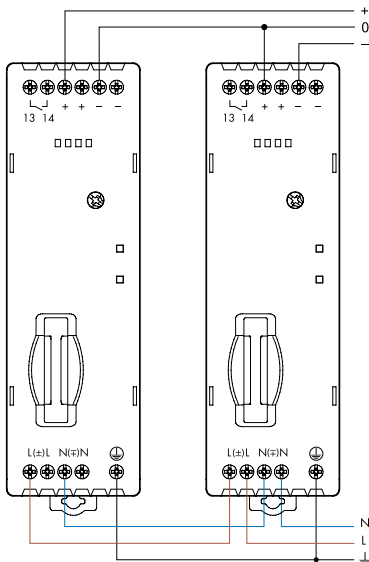

Parallel connection

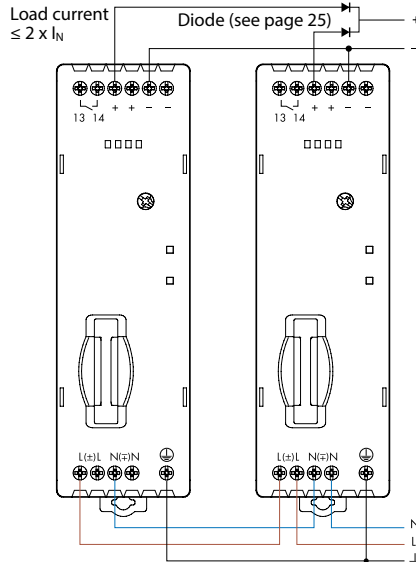

Series connection

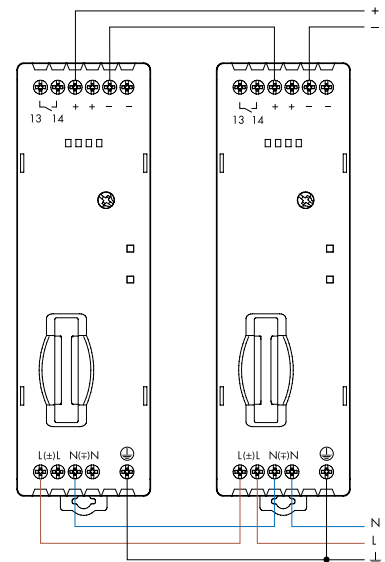

Wiring diagrams for 78.2E

Basic connections

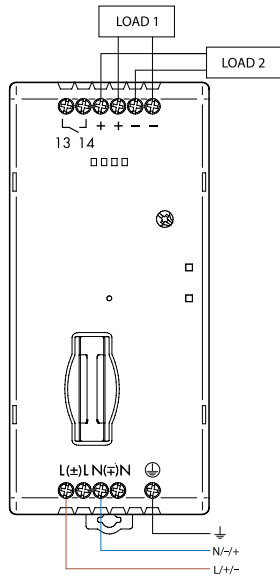

Dual polarity connection

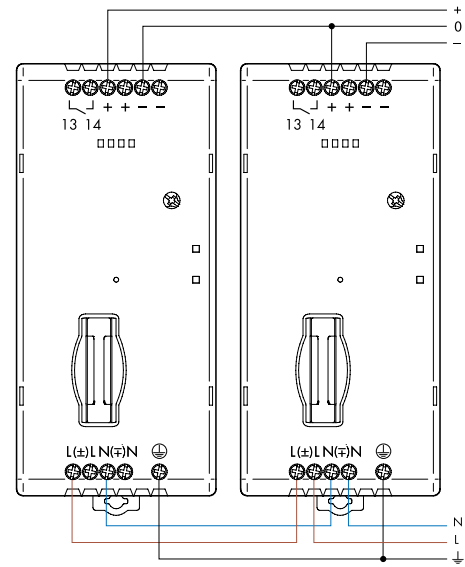

Parallel connection

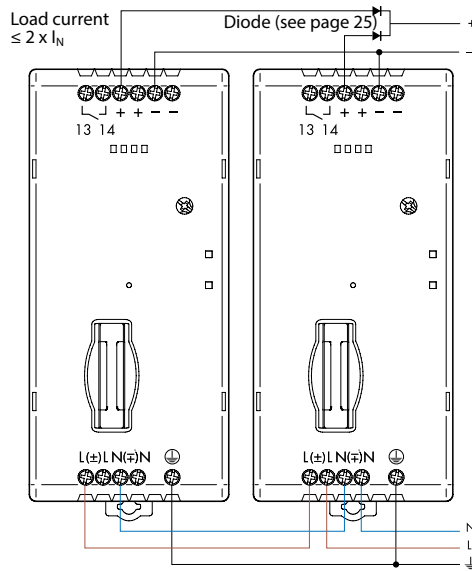

Series connection

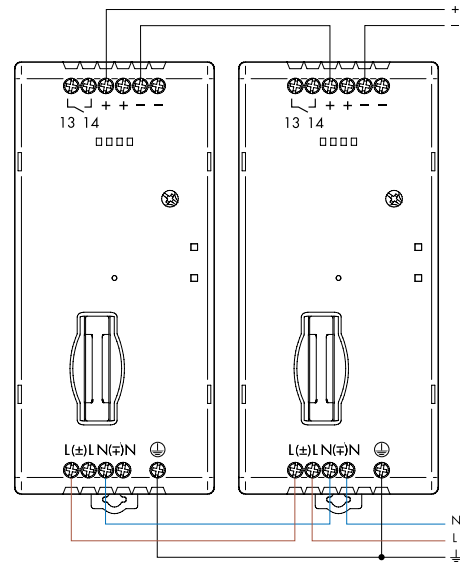

Wiring diagram for 78.1A

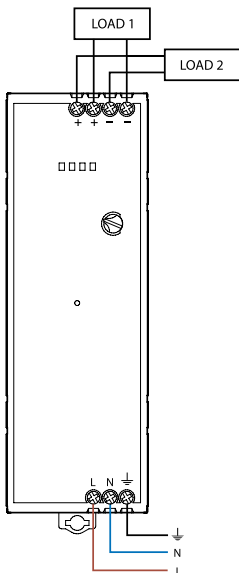

Wiring diagram for 78.2A

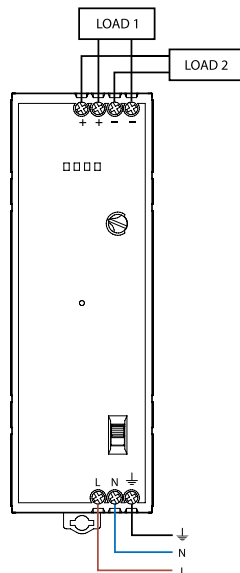

Wiring diagram for 78.2K

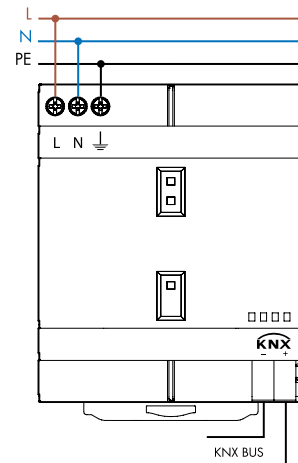



Diode(s)

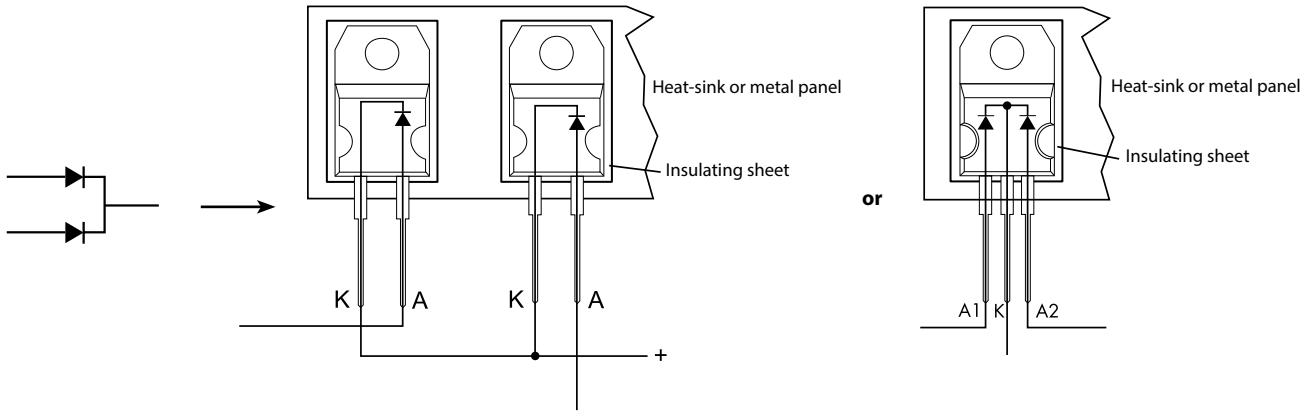

Diode for type 78.25, 78.36, 78.50, 78.60

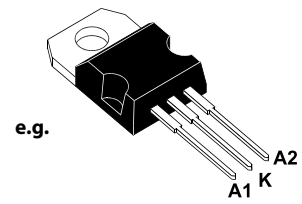
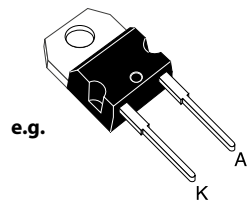

Diode for type 78.1B, 78.1D, 78.2E

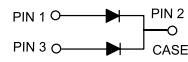
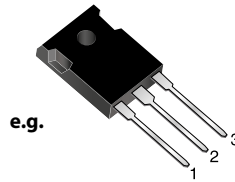

**TO-247AD**  
**MBR 4060PT**



Outline drawings

Type 78.12  
Screw terminal

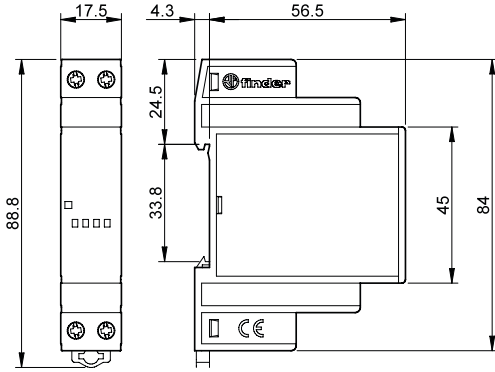

Type 78.25  
Screw terminal

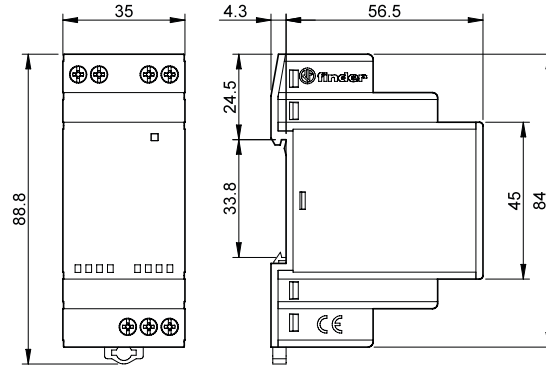

Types 78.36 / 78.50 / 78.60  
Screw terminal

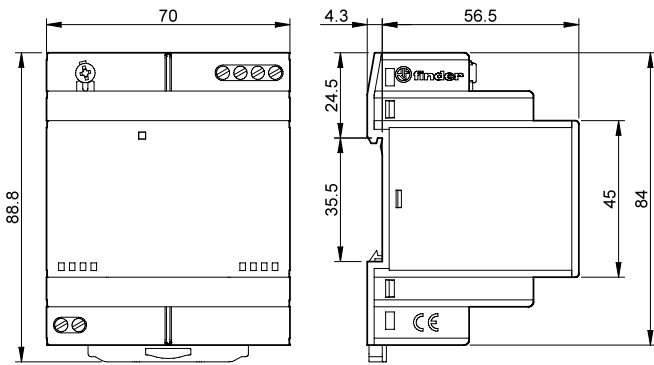

Type 78.1B  
Screw terminal

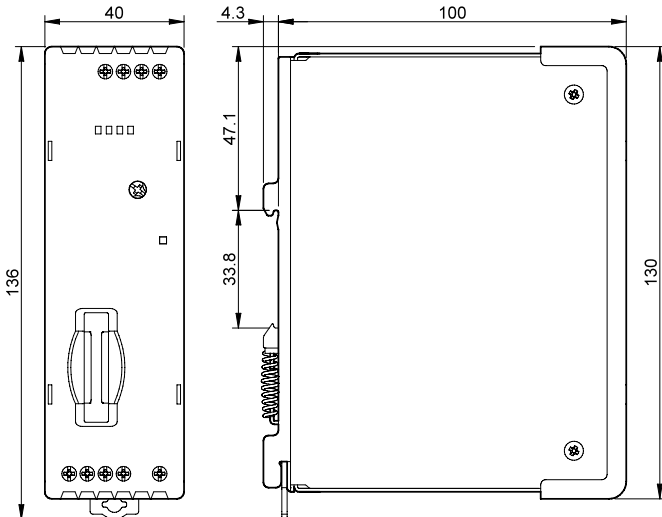

### Outline drawings

Type 78.1D  
Screw terminal

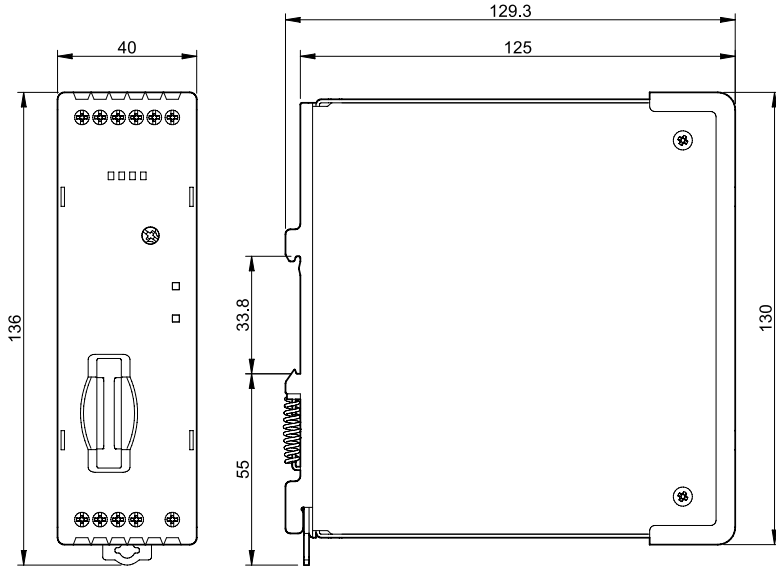

Type 78.2E  
Screw terminal

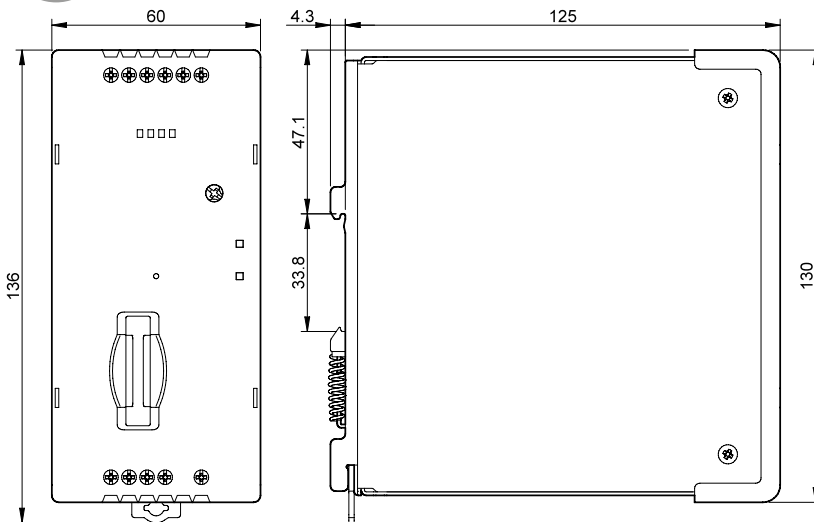

Outline drawings

Type 78.1A  
Screw terminal

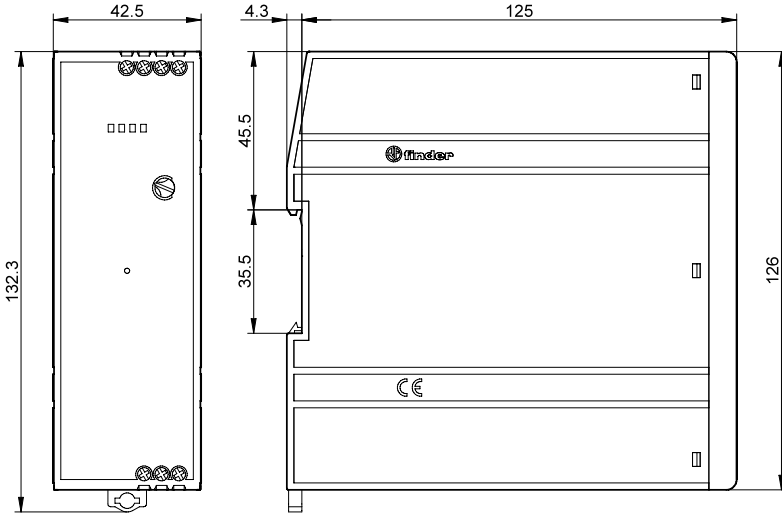

Type 78.2A  
Screw terminal

F

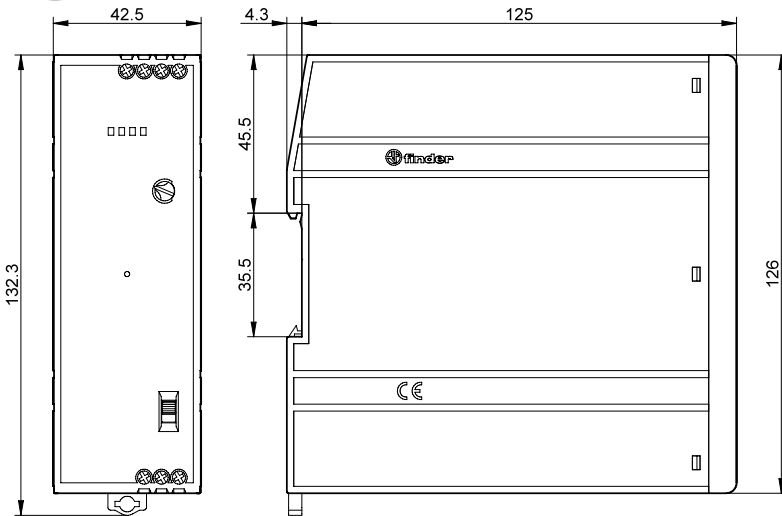

## Outline drawings

Type 78.2K  
Screw terminal

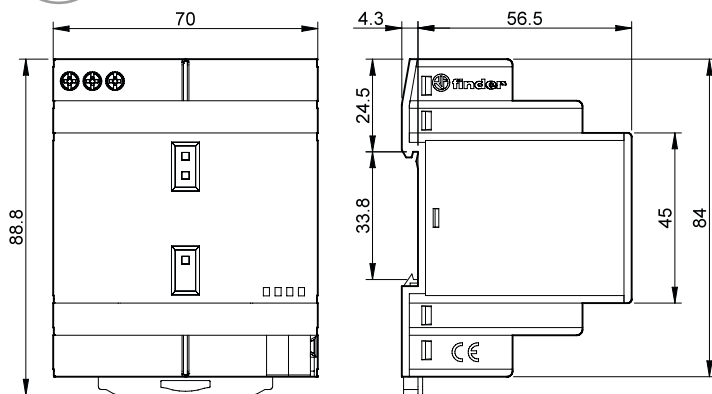

## Accessories

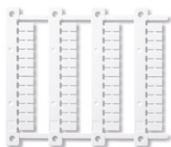

060.48

Sheet of marker tags (CEMBRE Thermal transfer printers), (48 tags), 6 x 12 mm

060.48



019.01

Identification tag, plastic, 1 tag, 17 x 25.5 mm (for 78.12/25/36/50/60)

019.01

F



# Panel Thermo-Hygrostat and Thermostats

7T  
SERIES



Drying kilns



Industrial refrigeration



Road / tunnel lighting



Industrial furnaces and ovens



Automatic car-washes



Panels for electrical distribution



Control panels



Forced-air ventilators







**Panel Thermo-Hygrostat**

- Small, compact size (17.5 mm wide)
- Electronic control
- 4 functions
- Nominal voltage 110...240 V AC/DC
- Temperature ranges from +10 ° to +60°C
- Humidity range up to 90%
- LED status indication contact ON
- 35 mm rail (EN 60715) mount

**Panel thermostat**

- Small, compact size (17.5 mm wide)
- Snap action themostatic Bimetal sensor
- Wide temperature setting range
- Long electrical life
- 35 mm rail (EN 60715) mount

**NEW 7T.51**



- Thermo-Hygrostatic control
- Nominal voltage 110...240 V AC/DC

**7T.81.0.000.240x**



- Heating control

**7T.81.0.000.230x**



- Ventilation control

\* Measured with 0.3 K/min  
\*\* Measured with 0.5 %/min

For outline drawing see page 6

**Contact specification**

Contact configuration		1 NO (SPST-NO)	1 NC (SPST-NC)	1 NO (SPST-NO)
Rated current/Maximum peak current	A	10/15	10/20	10/20
Rated voltage/ Maximum switching voltage	V AC	250/400	250/250	250/250
Rated load AC1	VA	2500	2500	2500
Rated load AC15 (230 V AC)	VA	500	250	250
Single phase motor rating AC3 (230 V AC)	kW	—	1.1	1.1
Breaking capacity DC1: 24/110/220 V	A	10/0.3/0.12	1/0.3/0.15	1/0.3/0.15
Minimum switching load	mW (V/mA)	500 (12/10)	500 (12/10)	500 (12/10)
Standard contact material		AgNi	AgNi	AgNi

**Coil specifications**

Nominal Voltage	V AC/DC	110...240	—	—
Rated Power	VA (50Hz)/W	1.8/0.44	—	—
Operating range	V AC/DC	88...264	—	—

**Temperature specifications \***

Setting range (ventilation)	°C	+10...+60	-20...+40	-20...+60	0...+60	-20...+40	-20...+60	0...+60
Switch differential	K	4 ± 2	7 ± 4			7 ± 4		
Setting accuracy full range	K	-1...+3	—			—		

**Humidity specifications \*\***

Setting range (humidity)	%	50...90	—			—		
Hysteresis	%	4 ± 2	—			—		
Setting accuracy	%	5	—			—		

**Technical data**

Electrical life at rated load AC1	cycles	100 · 10 <sup>3</sup>	100 · 10 <sup>3</sup>			100 · 10 <sup>3</sup>		
Ambient temperature range	°C	-25...+60	-45...+80			-45...+80		
Protection category		IP 20	IP 20			IP 20		

**Approvals** (according to type)



## Ordering information

Example: 7T Series, Thermo-Hygrostat for temperature and humidity control, 110...240 V AC/DC, Multifunction, 35 mm rail (EN 60715) mount.

**7 T . 5 1 . 0 . 2 3 0 . 4 3 6 0**

**Series**  
**Type**  
5 = Thermo-Hygrostatic control  
8 = Temperature control

**No. of contacts**  
1 = 1 contact

**Voltage type**  
0 = AC/DC (only 7T.51)  
0 = No operating voltage required (only 7T.81)

**Rated operating voltage**  
230 = 110...240 V (only 7T.51)  
000 = No operating voltage required

**Control function**  
60 = Multifunction (only 7T.51)  
01 = -20...+40 °C (only 7T.81)  
02 = -20...+60 °C (only 7T.81)  
03 = 0...+60 °C (only 7T.81)

**Contact configuration**  
3 = 1 NO contact  
4 = 1 NC contact

**Monitoring function**  
2 = Temperature control  
4 = Temperature and Humidity, adjustable

## Technical data

Insulation		7T.51	7T.81
Dielectric strength between open contacts	V AC	1000	500
Dielectric strength between supply and contact	V AC	2000	—
Other data			
Screw torque	Nm	0.5	0.5
Max. wire size		solid cable	stranded cable
	mm <sup>2</sup>	1 x 2.5	1 x 1.5
	AWG	1 x 12	1 x 16

## Functions 7T.51

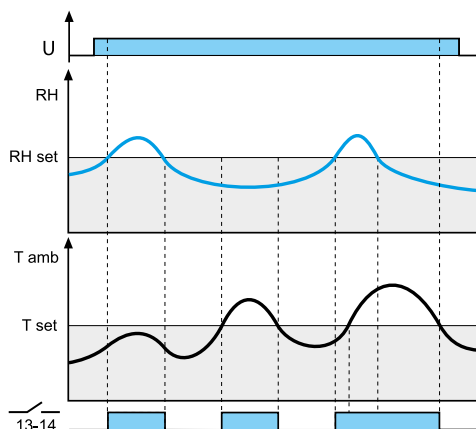

### HT: RH > RHset OR Tamb > Tset

Power is permanently applied to the thermo-hygrostat.  
The contact 13-14 closes if the ambient humidity (RH) is > of set humidity (RHset) OR if the ambient temperature (Tamb) is > of set temperature (Tset).

When contact is close, LED is ON

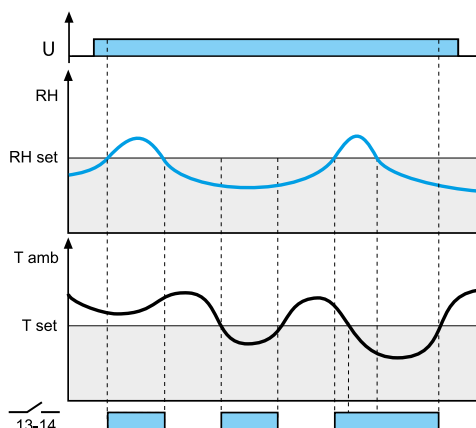

### TH: RH > RHset OR Tamb < Tset

The contact 13-14 closes if the ambient humidity (RH) is > of set humidity (RHset) OR if the ambient temperature (Tamb) is < of set temperature (Tset).

When contact is close, LED is ON

### Functions 7T.51

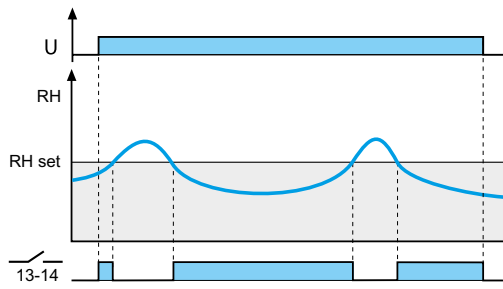

#### HL: $RH < RH_{set}$

The contact 13-14 closes if the ambient humidity (RH) is < of set humidity ( $RH_{set}$ )

When contact is close, LED is ON

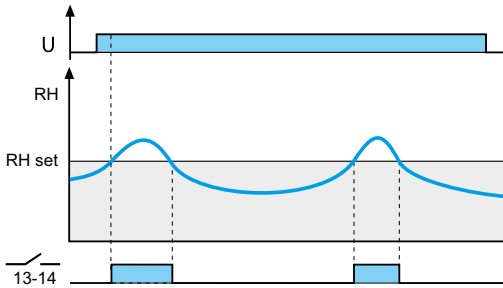

#### HM: $RH > RH_{set}$

The contact 13-14 closes if the ambient humidity (RH) is > of set humidity ( $RH_{set}$ )

When contact is close, LED is ON

### Functions 7T.81

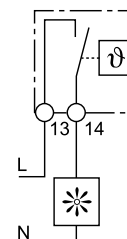
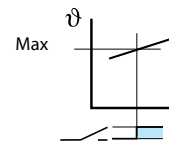
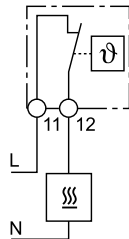
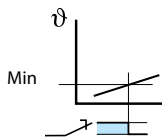

**Heating control** - Should the panel temperature fall below the (minimum) set temperature the contact will close to call for heat. The contact will open when this set temperature is exceeded.

**Ventilation control** - Should the panel temperature exceed the (maximum) set temperature then the contact will close to call for cooling. The contact will open when the temperature falls below this set temperature.

G

## Wiring diagrams

7T.51

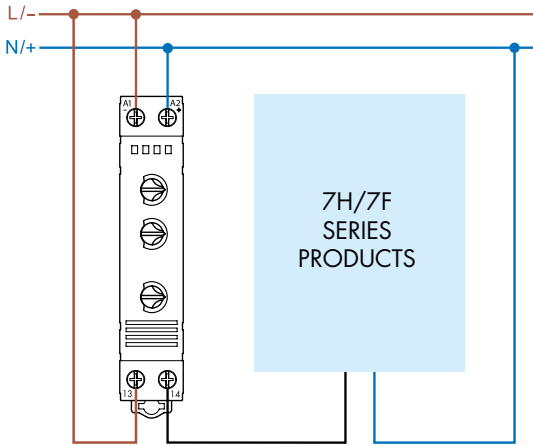

7T.81...230x

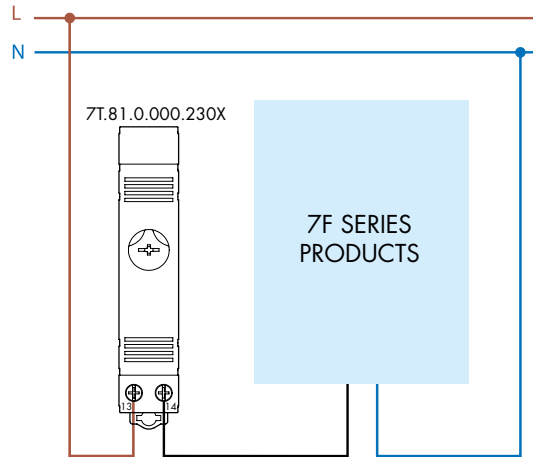

7T.81...240x

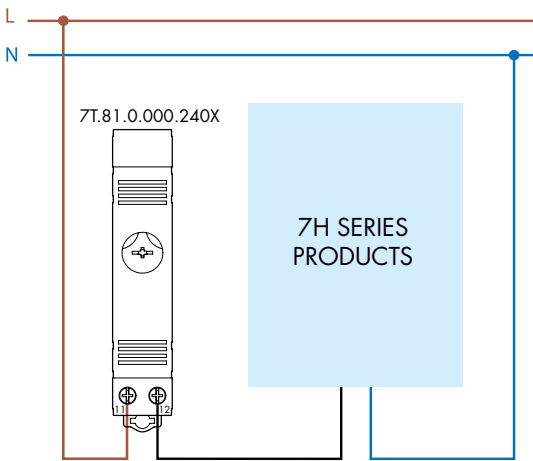

G

## Outline drawings

Type 7T.51

Screw terminal

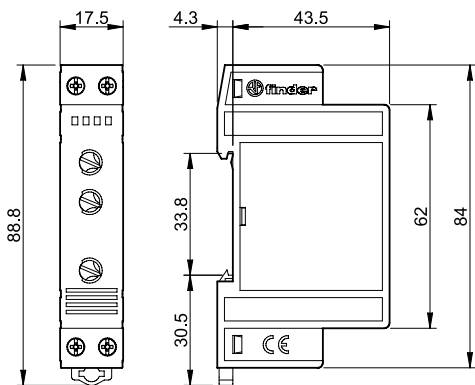

Type 7T.81

Screw terminal

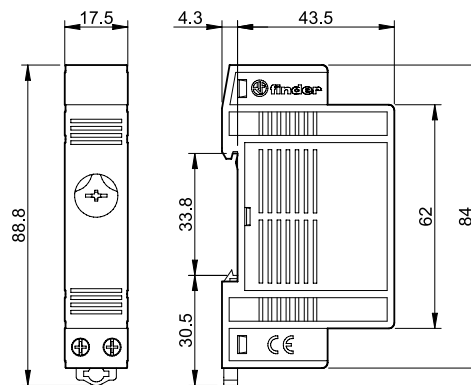

# Filter Fans (24...700)m<sup>3</sup>/h and Exhaust Filters

7F  
SERIES



Drying kilns



Textile machines



Machines  
for paper  
processing



Machines  
for ceramics



Wood-  
processing  
machines



Panels for  
electrical  
distribution



Control panels



Forced-air  
ventilators





**Filter Fans for electrical cabinets and enclosures 120 V or 230 V AC versions**

**Types 7F.20** for indoor use

**Types 7F.30** for outdoor use

- Very low acoustic noise
- Minimal depth within enclosure
- Nominal voltage: 120 or 230 V AC (50/60 Hz)
- Time-saving installation and maintenance
- Easily replaceable filter mat
- Filter Fan supplied in Reverse flow mode (7F.21 for indoor use, 7F.31 for outdoor use)
- Black colour RAL 9004 Available (only for 7F.20)

**NEW** 7F.20.8.xxx.1020  
7F.30.8.xxx.1020



- Nominal voltage 120 or 230 V AC
- Air volume 50/60 Hz: 24/29 m<sup>3</sup>/h
- Size 1

**NEW** 7F.20.8.xxx.2055  
7F.30.8.xxx.2055



- Nominal voltage 120 or 230 V AC
- Air volume 50/60 Hz: 55/63 m<sup>3</sup>/h
- Size 2

**NEW** 7F.20.8.xxx.3100  
7F.30.8.xxx.3100



- Nominal voltage 120 or 230 V AC
- Air volume 50/60 Hz: 100/115 m<sup>3</sup>/h
- Size 3

For outline drawing see page 14

**Fan data**

Air volume (free flow): 50/60 Hz	m <sup>3</sup> /h	24/29		55/63		100/115	
Air volume (with exhaust filter installed): 50/60 Hz	m <sup>3</sup> /h	14/16.5		40/45.5		75/85.5	
Noise level	dB (A)	27		42		42	
Life time at 40 °C	h	50 000		50 000		50 000	

**Electrical data**

Nominal voltage (U <sub>N</sub> )	V AC (50/60 Hz)	120	230	120	230	120	230
Operating range	AC	(0...1.1)U <sub>N</sub>		(0.8...1.1)U <sub>N</sub>		(0.8...1.1)U <sub>N</sub>	
Current consumption: 50/60 Hz	A	0.23/0.18	0.1/0.08	0.25/0.21	0.13/0.11	0.25/0.21	0.13/0.11
Rated power: 50/60 Hz	W	27/21	23/18	30/25	29/25	30/25	29/25

**Other data**

Housing, cover	Plastics according to UL94 V-0						
Filter mat (included)	G3 according to EN 779, filtering degree (80...90)%						
Filter material	Synthetic fibre with progressive construction, temperature resistant to +100 °C, self extinguishing, Class F1 (DIN 53438)						
Electrical connections	Push-in terminals						
Wire size (mm <sup>2</sup> )	min/max	0.7/2.5					
Wire size (AWG)	min/max	18/14					
Ambient temperature range	°C	-15...+55 (-30...+55 for 7F.30)					
Protection category according to EN 60529		IP 54					
Protection category according to NEMA (7F.20)		Type 12					
Protection category according to NEMA (7F.30)		Type 3R					

**Approvals** (according to type)



**Filter Fans for electrical cabinets and enclosures 120 V or 230 V AC versions**

**Types 7F.20 for indoor use**

**Types 7F.30 for outdoor use**

- Very low acoustic noise
- Minimal depth within enclosure
- Nominal voltage: 120 or 230 V AC (50/60 Hz)
- Time-saving installation and maintenance
- Easily replaceable filter mat
- Filter Fan supplied in Reverse flow mode (7F.21 for indoor use, 7F.31 for outdoor use)
- Black colour RAL 9004 Available (only for 7F.20)

**NEW** 7F.20.8.xxx.4250  
**NEW** 7F.30.8.xxx.4250



- Nominal voltage 120 or 230 V AC
- Air volume 50/60 Hz: 250/295 m<sup>3</sup>/h
- Size 4

**NEW** 7F.20.8.xxx.4400  
**NEW** 7F.30.8.xxx.4400



- Nominal voltage 120 or 230 V AC
- Air volume 50/60 Hz: 400/445 m<sup>3</sup>/h
- Size 4

G

For outline drawing see page 15

**Fan data**

Air volume (free flow): 50/60 Hz	m <sup>3</sup> /h	250/295	400/445
Air volume (with exhaust filter installed): 50/60 Hz	m <sup>3</sup> /h	195/228	270/300
Noise level	dB (A)	56	72
Life time at 40 °C	h	50 000	50 000

**Electrical data**

Nominal voltage (U <sub>N</sub> )	V AC (50/60 Hz)	120	230	120	230
Operating range	AC	(0.8...1.1)U <sub>N</sub>		(0.8...1.1)U <sub>N</sub>	
Current consumption: 50/60 Hz	A	0.35/0.40	0.2/0.22	0.6/1	0.3/0.49
Rated power: 50/60 Hz	W	42/48	46/50	72/120	69/112

**Other data**

Housing, cover	Plastics according to UL94 V-0			
Filter mat (included)	G3 according to EN 779, filtering degree (80...90)%	G4 according to EN 779, filtering degree (80...90)%		
Filter material	Synthetic fibre with progressive construction, temperature resistant to +100 °C, self extinguishing, Class F1 (DIN 53438)			
Electrical connections	Push-in terminals			
Wire size (mm <sup>2</sup> )	min/max	0.7/2.5		
Wire size (AWG)	min/max	18/14		
Ambient temperature range	°C	-15...+55 (-30...+55 for 7F.30)		
Protection category according to EN 60529	IP 54			
Protection category according to NEMA (7F.20)	Type 12			
Protection category according to NEMA (7F.30)	Type 3R			

**Approvals (according to type)**





**Filter Fans for electrical cabinets and enclosures 120 V or 230 V AC versions**

**Types 7F.20 for indoor use**

**Types 7F.30 for outdoor use**

- Very low acoustic noise
- Minimal depth within enclosure
- Nominal voltage: 120 or 230 V AC (50/60 Hz)
- Time-saving installation and maintenance
- Easily replaceable filter mat
- Filter Fan supplied in Reverse flow mode (7F.21 for indoor use, 7F.31 for outdoor use)
- Black colour RAL 9004 Available (only for 7F.20)

**NEW** 7F.20.8.xxx.5550  
**NEW** 7F.30.8.xxx.5550



- Nominal voltage 120 or 230 V AC
- Air volume 50/60 Hz: 550/605 m<sup>3</sup>/h
- Size 5

**NEW** 7F.20.8.xxx.5700  
**NEW** 7F.30.8.xxx.5700



- Nominal voltage 120 or 230 V AC
- Air volume 50/60 Hz: 660/700 m<sup>3</sup>/h
- Size 5

For outline drawing see page 15

**Fan data**

Air volume (free flow): 50/60 Hz	m <sup>3</sup> /h	550/605		660/700	
Air volume (with exhaust filter installed): 50/60 Hz	m <sup>3</sup> /h	400/440		430/470	
Noise level	dB (A)	75		72	
Life time at 40 °C	h	50 000		50 000	

**Electrical data**

Nominal voltage (U <sub>N</sub> )	V AC (50/60 Hz)	120	230	120	230
Operating range	AC	(0.8...1.1)U <sub>N</sub>		(0.8...1.1)U <sub>N</sub>	
Current consumption: 50/60 Hz	A	0.66/0.85	0.34/0.49	0.92/1.14	0.46/0.53
Rated Power: 50/60 Hz	W	75/102	76/116	110/140	106/120

**Other data**

Housing, cover	Plastics according to UL94 V-0, light grey (RAL 7035)			
Filter mat (included)	G4 according to EN 779, filtering degree (80...90)%	G3 according to EN 779, filtering degree (80...90)%		
Filter material	Synthetic fibre with progressive construction, temperature resistant to +100 °C, self extinguishing, Class F1 (DIN 53438)			
Electrical connections	Push-in terminals		Screw Terminal	
Wire size (mm <sup>2</sup> )	min/max	0.7/2.5		
Wire size (AWG)	min/max	18/14		
Ambient temperature range	°C	-15...+55 (-30...+55 for 7F.30)		
Protection category according to EN 60529	IP 54			
Protection category according to NEMA (7F.20)	Type 12			
Protection category according to NEMA (7F.30)	Type 3R			

**Approvals** (according to type)



**Filter Fans for electrical cabinets and enclosures 24 V DC versions**

**Types 7F.20 for indoor use**

**Types 7F.30 for outdoor use**

- Very low acoustic noise
- Minimal depth within enclosure
- Nominal voltage: 24 V DC
- Time-saving installation and maintenance
- Easily replaceable filter mat
- Filter Fan supplied in Reverse flow mode (7F.21 for indoor use, 7F.31 for outdoor use)
- Black colour RAL 9004 Available (only for 7F.20)

**NEW** 7F.20.9.024.1020  
**NEW** 7F.30.9.024.1020



- Nominal voltage 24 V DC
- Air volume 24 m<sup>3</sup>/h
- Rated power 3.6 W
- Size 1

**NEW** 7F.20.9.024.2055  
**NEW** 7F.30.9.024.2055



- Nominal voltage 24 V DC
- Air volume 55 m<sup>3</sup>/h
- Rated power 7 W
- Size 2

**NEW** 7F.20.9.024.3100  
**NEW** 7F.30.9.024.3100



- Nominal voltage 24 V DC
- Air volume 100 m<sup>3</sup>/h
- Rated power 7 W
- Size 3

For outline drawing see page 14

Fan data				
Air volume (free flow)	m <sup>3</sup> /h	24	55	100
Air volume (with exhaust filter installed)	m <sup>3</sup> /h	14	40	75
Noise level	dB (A)	37.5	46	45
Life time at 40 °C	h	50 000	50 000	50 000
Electrical data				
Nominal voltage (U <sub>N</sub> )	V DC	24	24	24
Operating range	DC	(0.8...1.1)U <sub>N</sub>	(0.8...1.1)U <sub>N</sub>	(0.8...1.1)U <sub>N</sub>
Current consumption	A	0.15	0.32	0.32
Rated power	W	3.6	7	7
Other data				
Housing, cover		Plastics according to UL94 V-0		
Filter mat (included)		G3 according to EN 779, filtering degree (80...90)%		
Filter material		Synthetic fibre with progressive construction, temperature resistant to 100 °C, self extinguishing, Class F1 (DIN 53438)		
Electrical connections		Push-in terminals		
Wire size (mm <sup>2</sup> )	min/max	0.7/2.5		
Wire size (AWG)	min/max	18/14		
Ambient temperature range	°C	-15...+55 (-30...+55 for 7F.30)		
Protection category according to EN 60529		IP 54		
Protection category according to NEMA (7F.20)		Type 12		
Protection category according to NEMA (7F.30)		Type 3R		
<b>Approvals</b> (according to type)				

**Filter Fans for electrical cabinets and enclosures 24 V DC versions**

**Types 7F.20 for indoor use**

**Types 7F.30 for outdoor use**

- Very low acoustic noise
- Minimal depth within enclosure
- Nominal voltage: 24 V DC
- Time-saving installation and maintenance
- Easily replaceable filter mat
- Filter Fan supplied in Reverse flow mode (7F.21 for indoor use, 7F.31 for outdoor use)
- Black colour RAL 9004 Available (only for 7F.20)

**NEW** 7F.20.9.024.4250  
7F.30.9.024.4250



- Nominal voltage 24 V DC
- Air volume 250 m<sup>3</sup>/h
- Rated power 43 W
- Size 4

For outline drawing see page 15

**Fan data**

Air volume (free flow)	m <sup>3</sup> /h	250
Air volume (with exhaust filter installed)	m <sup>3</sup> /h	195
Noise level	dB (A)	64
Life time at 40 °C	h	50 000

**Electrical data**

Nominal voltage (U <sub>N</sub> )	V DC	24
Operating range	DC	(0.8...1.1)U <sub>N</sub>
Current consumption	A	1.8
Rated power	W	43

**Other data**

Housing, cover	Plastics according to UL94 V-0	
Filter mat (included)	G3 according to EN 779, filtering degree (80...90)%	
Filter material	Synthetic fibre with progressive construction, temperature resistant to 100 °C, self extinguishing, Class F1 (DIN 53438)	
Electrical connections	Push-in terminals	
Wire size (mm <sup>2</sup> )	min/max	0.7/2.5
Wire size (AWG)	min/max	18/14
Ambient temperature range	°C	-15...+55 (-30...+55 for 7F.30)
Protection category according to EN 60529	IP 54	
Protection category according to NEMA (7F.20)	Type 12	
Protection category according to NEMA (7F.30)	Type 3R	

**Approvals** (according to type)



## Ordering information

Example: Series 7F, Filter Fan for mounting in sidewalls, nominal voltage 230 V AC, size 1, air volume 24 m<sup>3</sup>/h, for indoor use.



- Series**
- Type**
- 20 = Filter Fan - for indoor use
  - 21 = Reverse flow Filter Fan - for indoor use
  - 30 = Filter Fan - for outdoor use
  - 31 = Reverse flow Filter Fan - for outdoor use

- Supply version**
- 8 = AC (50/60 Hz)
  - 9 = DC

- Operating voltage**
- 024 = 24 V DC
  - 120 = 120 V AC
  - 230 = 230 V AC

- Enclosure cut-out**
- 1 = Size 1 (92<sup>+1.0</sup> x 92<sup>+1.0</sup>) mm
  - 2 = Size 2 (125<sup>+1.0</sup> x 125<sup>+1.0</sup>) mm
  - 3 = Size 3 (177<sup>+1.0</sup> x 177<sup>+1.0</sup>) mm
  - 4 = Size 4 (223<sup>+1.0</sup> x 223<sup>+1.0</sup>) mm
  - 5 = Size 5 (291<sup>+1.0</sup> x 291<sup>+1.0</sup>) mm

- Nominal air volume (free flow)**
- 020 = 24 m<sup>3</sup>/h
  - 055 = 55 m<sup>3</sup>/h
  - 100 = 100 m<sup>3</sup>/h
  - 250 = 250 m<sup>3</sup>/h
  - 400 = 400 m<sup>3</sup>/h
  - 550 = 550 m<sup>3</sup>/h
  - 700 = 700 m<sup>3</sup>/h

- Colour**
- Empty = Grey RAL 7035 (7F.20)
  - Grey RAL 7000 (7F.30)
  - 0 = Black RAL 9004 (only for 7F.20)

G

### Filter Fans - All versions

Standard indoor versions	Standard outdoor versions	Reverse flow indoor versions	Reverse flow outdoor versions	
7F.20.8.120.1020	7F.30.8.120.1020	7F.21.8.120.1020	7F.31.8.120.1020	Filter Fan, Size 1
7F.20.8.120.2055	7F.30.8.120.2055	7F.21.8.120.2055	7F.31.8.120.2055	Filter Fan, Size 2
7F.20.8.120.3100	7F.30.8.120.3100	7F.21.8.120.3100	7F.31.8.120.3100	Filter Fan, Size 3
7F.20.8.120.4250	7F.30.8.120.4250	7F.21.8.120.4250	7F.31.8.120.4250	Filter Fan, Size 4
7F.20.8.120.4400	7F.30.8.120.4400	7F.21.8.120.4400	7F.31.8.120.4400	Filter Fan, Size 4
7F.20.8.120.5550	7F.30.8.120.5550	7F.21.8.120.5550	7F.31.8.120.5550	Filter Fan, Size 5
7F.20.8.120.5700	7F.30.8.120.5700	7F.21.8.120.5700	7F.31.8.120.5700	Filter Fan, Size 5
7F.20.8.230.1020	7F.30.8.230.1020	7F.21.8.230.1020	7F.31.8.230.1020	Filter Fan, Size 1
7F.20.8.230.2055	7F.30.8.230.2055	7F.21.8.230.2055	7F.31.8.230.2055	Filter Fan, Size 2
7F.20.8.230.3100	7F.30.8.230.3100	7F.21.8.230.3100	7F.31.8.230.3100	Filter Fan, Size 3
7F.20.8.230.4250	7F.30.8.230.4250	7F.21.8.230.4250	7F.31.8.230.4250	Filter Fan, Size 4
7F.20.8.230.4400	7F.30.8.230.4400	7F.21.8.230.4400	7F.31.8.230.4400	Filter Fan, Size 4
7F.20.8.230.5550	7F.30.8.230.5550	7F.21.8.230.5550	7F.31.8.230.5550	Filter Fan, Size 5
7F.20.8.230.5700	7F.30.8.230.5700	7F.21.8.230.5700	7F.31.8.230.5700	Filter Fan, Size 5
7F.20.9.024.1020	7F.30.9.024.1020	7F.21.9.024.1020	7F.31.9.024.1020	Filter Fan, Size 1
7F.20.9.024.2055	7F.30.9.024.2055	7F.21.9.024.2055	7F.31.9.024.2055	Filter Fan, Size 2
7F.20.9.024.3100	7F.30.9.024.3100	7F.21.9.024.3100	7F.31.9.024.3100	Filter Fan, Size 3
7F.20.9.024.4250	7F.30.9.024.4250	7F.21.9.024.4250	7F.31.9.024.4250	Filter Fan, Size 4

Note:  
The technical features (air volume, dimensions and electrical parameters) for the Standard Filter Fans (7F.20 and 7F.30) and the Reverse flow versions (7F.21 and 7F.31) - are exactly the same.

**Exhaust Filters**

Types 7F.02 for indoor use

Types 7F.03 for outdoor use

The size of the Exhaust Filter should match the size of the Filter Fan to achieve the best ventilation within the cabinet

- Minimum depth within enclosure
- Time-saving installation and maintenance
- Easily replaceable filter mat
- Black colour RAL 9004 Available (only for 7F.02)

**NEW** 7F.02.0.000.1000  
7F.03.0.000.1000



- For Filter Fans 7F.20.x.xxx.1020 or 7F.30.x.xxx.1020
- Size 1

**NEW** 7F.02.0.000.2000  
7F.03.0.000.2000



- For Filter Fans 7F.20.x.xxx.2055 or 7F.30.x.xxx.2055
- Size 2

**NEW** 7F.02.0.000.3000  
7F.03.0.000.3000



- For Filter Fans 7F.20.x.xxx.3100 or 7F.30.x.xxx.3100
- Size 3

For outline drawing see page 14

**Other data**

Housing, cover

Plastics according to UL94 V-0

Filter mat (included)

G3 according to EN 779, filtering degree (80...90)%

Filter material

Synthetic fibre with progressive construction, temperature resistant to +100 °C, self extinguishing, Class F1 (DIN 53438)

Ambient temperature range

°C

-15...+ 55 (-30...+55 for 7F.03)

Protection category according to EN 60529

IP 54

Protection category according to NEMA (7F.20)

Type 12

Protection category according to NEMA (7F.30)

Type 3R

**Approvals** (according to type)



**Exhaust Filters**

Types 7F.02 for **indoor** use

Types 7F.03 for **outdoor** use

The size of the Exhaust Filter should match the size of the Filter Fan to achieve the best ventilation within the cabinet

- Minimum depth within enclosure
- Time-saving installation and maintenance
- Easily replaceable filter mat
- Black colour RAL 9004 Available (only for 7F.02)

**7F.02.0.000.4000**  
**NEW 7F.03.0.000.4000**



- For Filter Fans  
7F.20.x.xxx.4250,  
7F.20.8.xxx.4440 or  
7F.30.x.xxx.4250,  
7F.30.8.xxx.4400
- Size 4

**7F.02.0.000.5000**  
**NEW 7F.03.0.000.5000**



- For Filter Fans  
7F.20.x.xxx.5550,  
7F.20.8.xxx.5700 or  
7F.30.x.xxx.5550,  
7F.30.8.xxx.5700
- Size 5

For outline drawing see page 15

**Other data**

Housing, cover	Plastics according to UL94 V-0, light grey (RAL 7035)
Filter mat (included)	G3 according to EN 779, filtering degree (80...90)%
Filter material	Synthetic fibre with progressive construction, temperature resistant to +100 °C, self extinguishing, Class F1 (DIN 53438)
Ambient temperature range °C	-15...+ 55 (-30...+55 for 7F.03)
Protection category according to EN 60529	IP 54
Protection category according to NEMA (7F.20)	Type 12
Protection category according to NEMA (7F.30)	Type 3R
<b>Approvals</b> (according to type)	

### Ordering information

Example: Series 7F, Exhaust Filter for mounting in sidewalls, for indoor use, size 1.

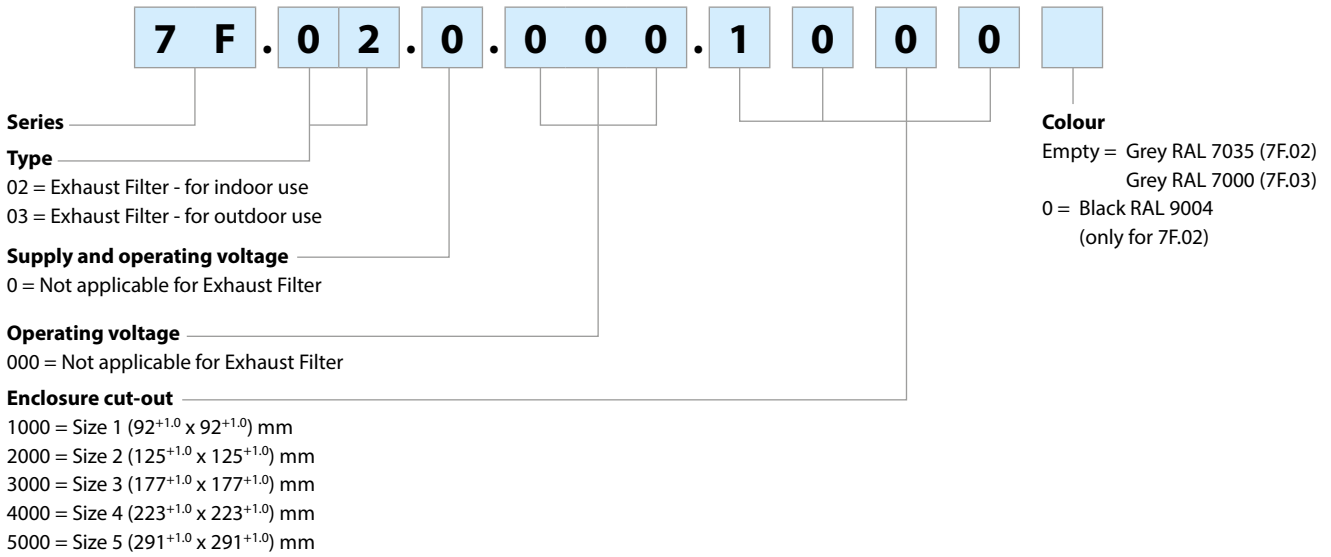

### Components

Standard Indoor Filter Fan	Standard Outdoor Filter Fan	Standard Indoor Exhaust Filter	Standard Outdoor Exhaust Filter	Filter mat	Size
7F.20.8.xxx.1020	7F.30.8.xxx.1020	7F.02.0.000.1000	7F.03.0.000.1000	07F.15	1
7F.20.8.xxx.2055	7F.30.8.xxx.2055	7F.02.0.000.2000	7F.03.0.000.2000	07F.25	2
7F.20.8.xxx.3100	7F.30.8.xxx.3100	7F.02.0.000.3000	7F.03.0.000.3000	07F.35	3
7F.20.8.xxx.4250	7F.30.8.xxx.4250	7F.02.0.000.4000	7F.03.0.000.4000	07F.45	4
7F.20.8.xxx.4400	7F.30.8.xxx.4400	7F.02.0.000.4000	7F.03.0.000.4000	07F.46 (07F.45 for 7F.0x-4000)	4
7F.20.8.xxx.5550	7F.30.8.xxx.5550	7F.02.0.000.5000	7F.03.0.000.5000	07F.56 (07F.55 for 7F.0x-5000)	5
7F.20.8.xxx.5700	7F.30.8.xxx.5700	7F.02.0.000.5000	7F.03.0.000.5000	07F.55	5
7F.20.9.024.1020	7F.30.9.024.1020	7F.02.0.000.1000	7F.03.0.000.1000	07F.15	1
7F.20.9.024.2055	7F.30.9.024.2055	7F.02.0.000.2000	7F.03.0.000.2000	07F.25	2
7F.20.9.024.3100	7F.30.9.024.3100	7F.02.0.000.3000	7F.03.0.000.3000	07F.35	3
7F.20.9.024.4250	7F.30.9.024.4250	7F.02.0.000.4000	7F.03.0.000.4000	07F.45	4

Spare Filter mats	07F.15	07F.25	07F.35	07F.45/46	07F.55/56
Protection category	IP54				

### Accessories



07F.80

Pressure compensation device, for pressure compensation in closed cabinets or enclosures	07F.80
Air interface area	cm <sup>2</sup> 7
Mounting	PG 29 thread with union nut
Torque	Nm 5 (max. 10)
Material	plastic according to UL94-V0
Dimensions (diameter/depth)	mm 65.5/30.5
Mounting position	upper part of cabinet sidewalls
Ambient temperature	°C -45...+70
Protection category	IP 55

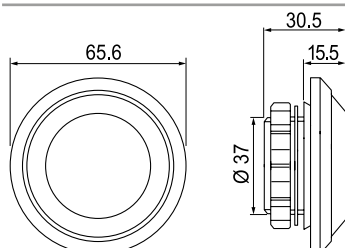

Unit package contains 2 pressure compensation devices



## Mounting instructions for Filter Fans

### Mounting arrangement of Filter Fans and Exhaust Filter

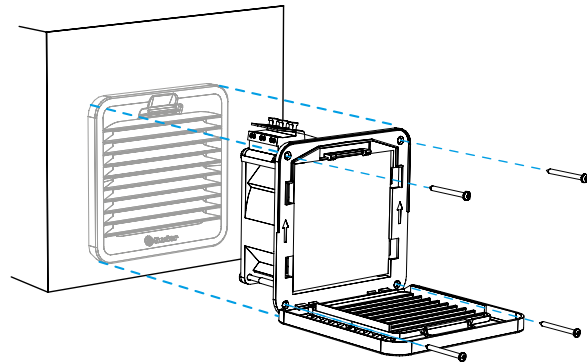
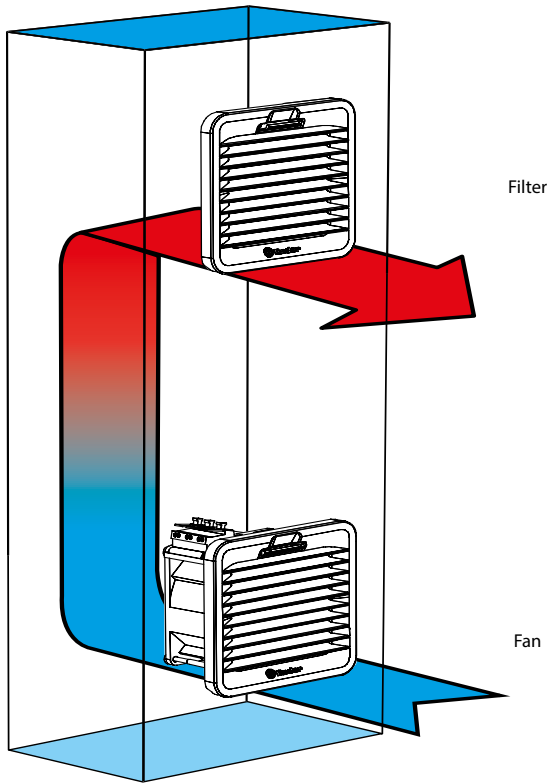

The installation with the only clips is optimized for 1.5 mm thick sheets; it is also possible with thicknesses from 1 to 2.5 mm. Fixing with screws (supplied) is recommended. Tightening torque 0.3 Nm.

## G

### Replacement of Filter mat

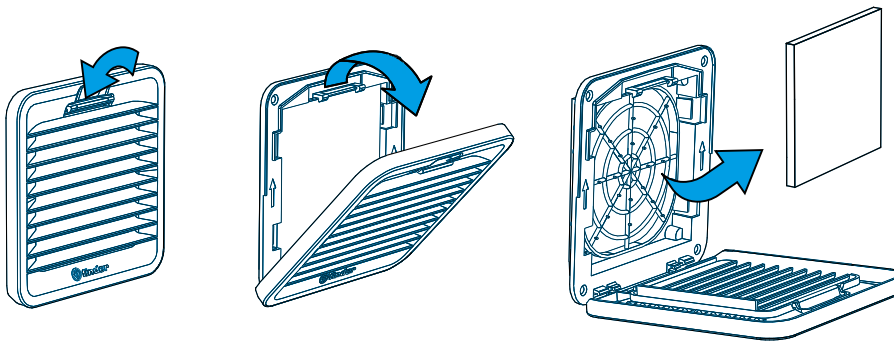



## Drilling template and mounting cut-outs for Filter Fans and Exhaust Filter

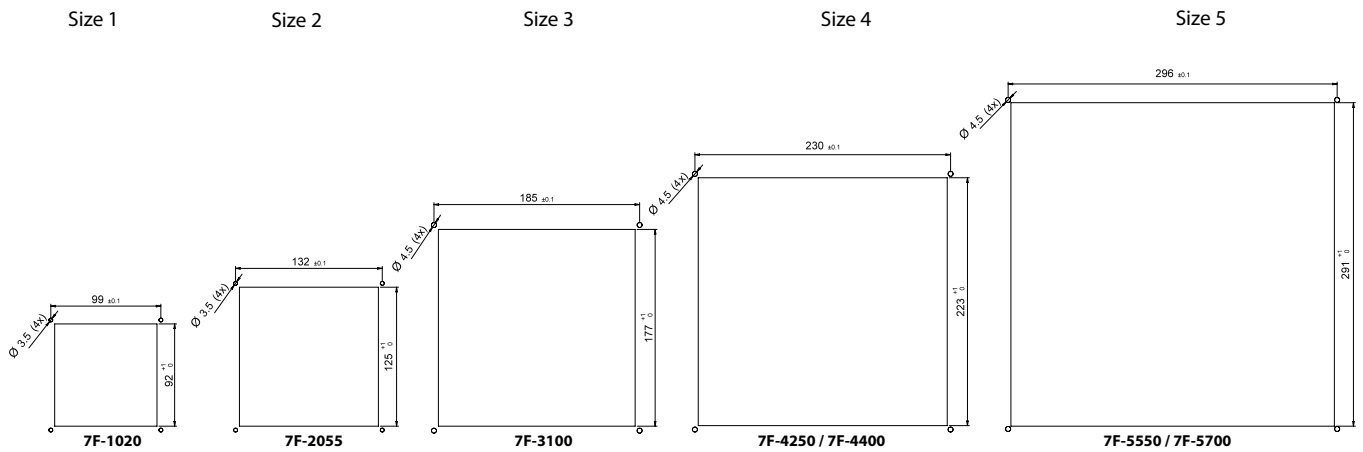

### Mounting and maintenance

1. Make the panel cut-out according to the size of the Filter Fan or Exhaust Filter in the sidewall of the cabinet as appropriate.  
A template of the panel cut-out is included in the packaging of the Filter Fan or Exhaust Filter.
2. Make the electrical connection.
3. Mount by simply snapping the side-located lugs on the Filter Fan or Exhaust Filter into the panel cut-out (without using screws for sidewall thickness of 1.2...2.4 mm).  
At other thickness it is recommended to mount the Filter Fan by the screws supplied (for size 1, the template shows the mounting cut-out only).
4. When screws are needed for the mounting, remove the plastic cover and fix the Filter Fan with the 4 screws supplied.  
Then insert the filter mat and snap the plastic cover to the mounting frame.
5. During maintenance or when replacing the filter mat remove the plastic cover, replace the filter mat and snap on the plastic cover.

Outline drawings

Type 7F.xx.x.xxx.1020

AC version

DC version

Type 7F.0x.0.000.1000

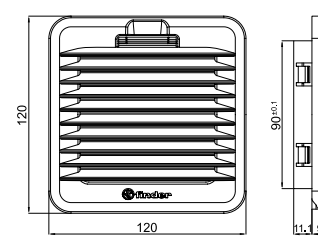
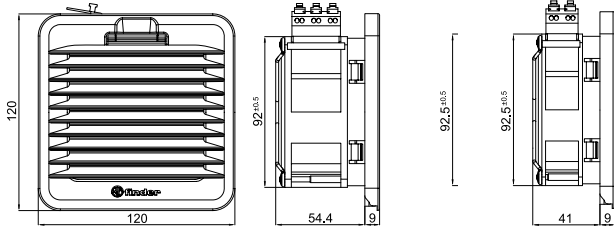

Type 7F.xx.x.xxx.2055

Type 7F.0x.0.000.2000

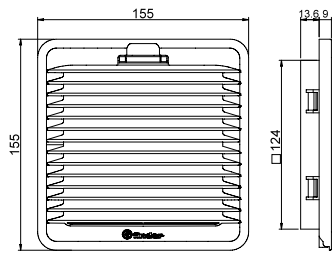
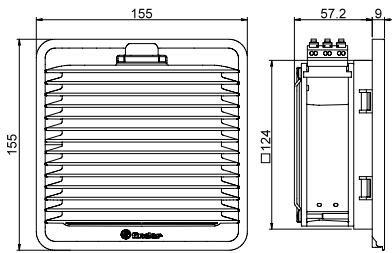

Type 7F.xx.x.xxx.3100

Type 7F.0x.0.000.3000

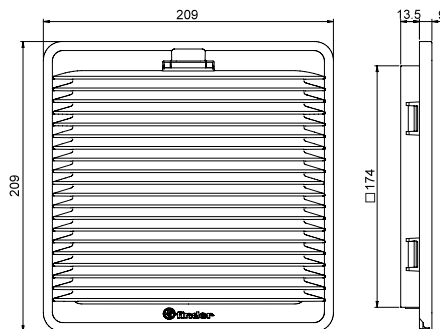
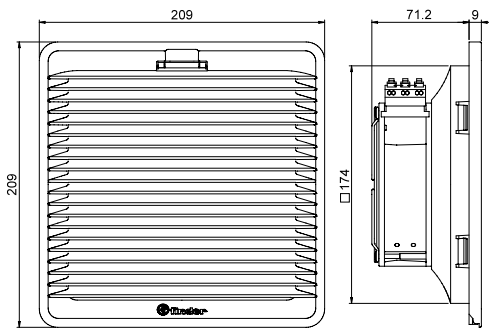

Type 7F.xx.x.xxx.4250

Type 7F.0x.0.000.4000

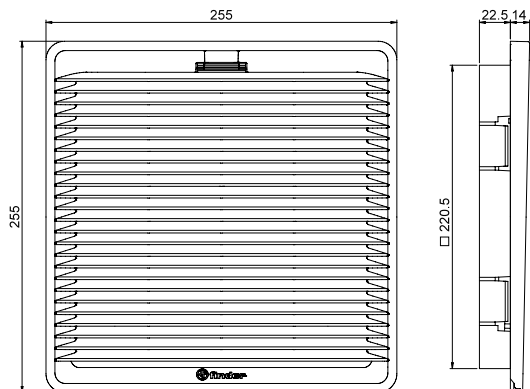
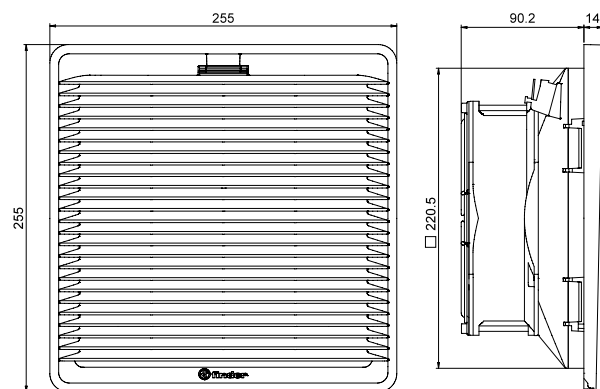

G

Outline drawings

Type 7F.xx.x.xxx.4400

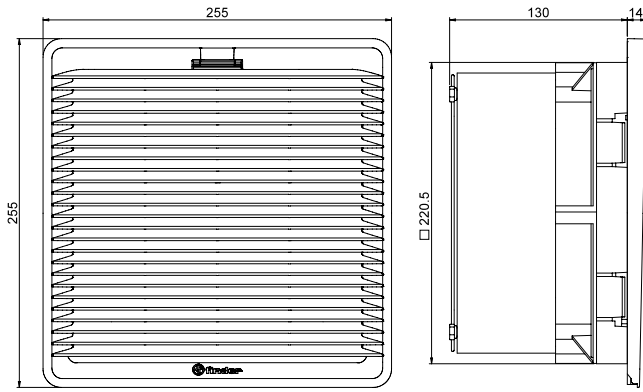

Type 7F.0x.0.000.4000

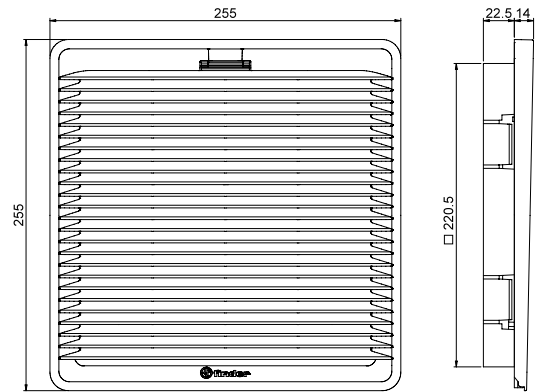

Type 7F.xx.x.xxx.5550

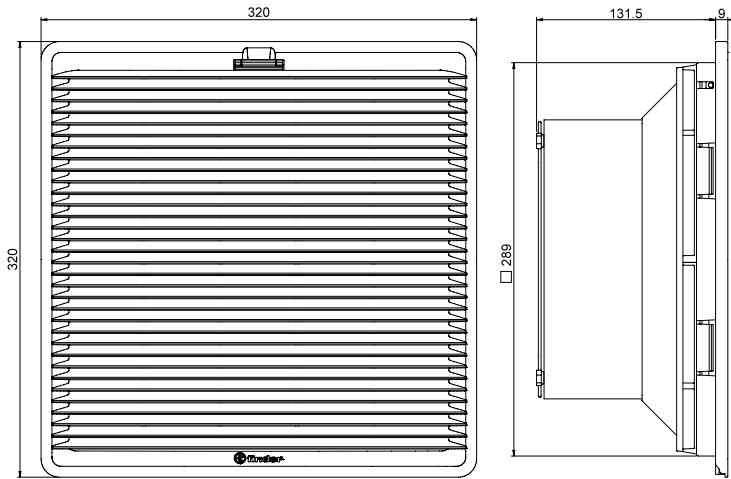

Type 7F.0x.0.000.5000

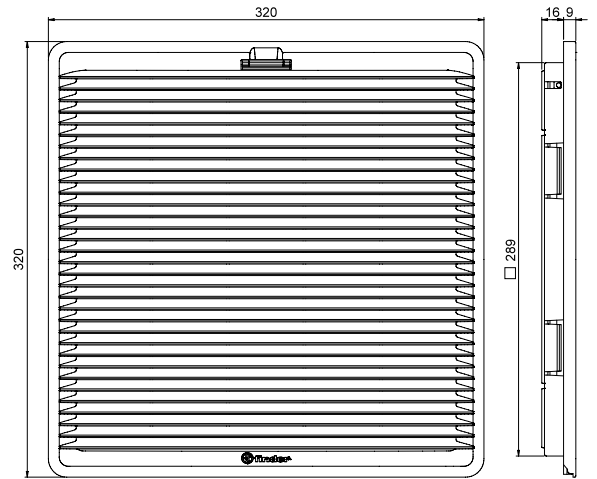

Type 7F.xx.x.xxx.5700

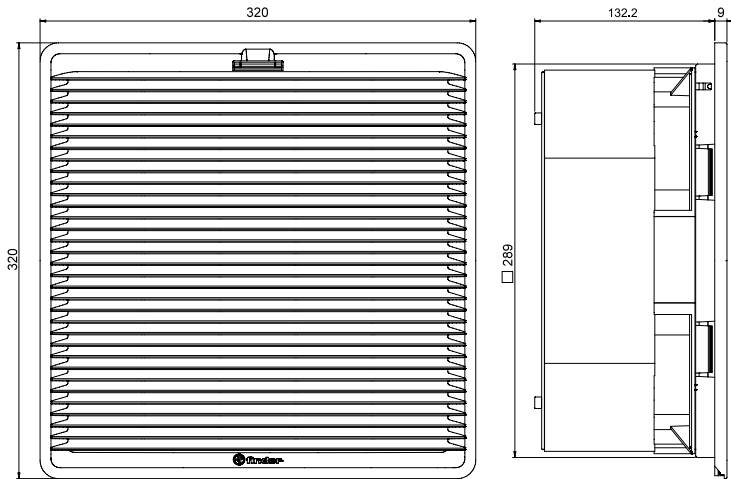

Type 7F.0x.0.000.5000

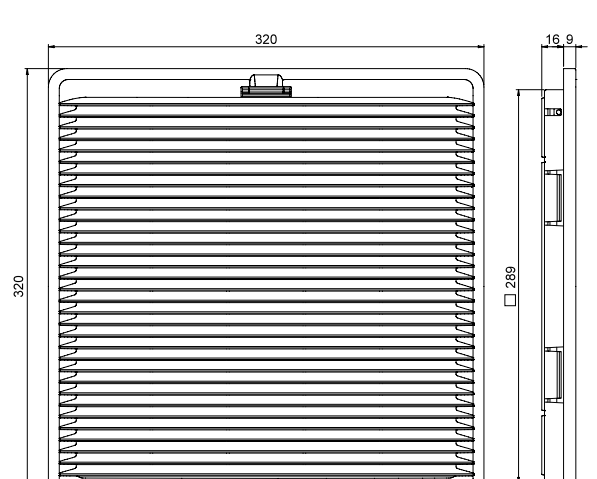

G

## Fan selection

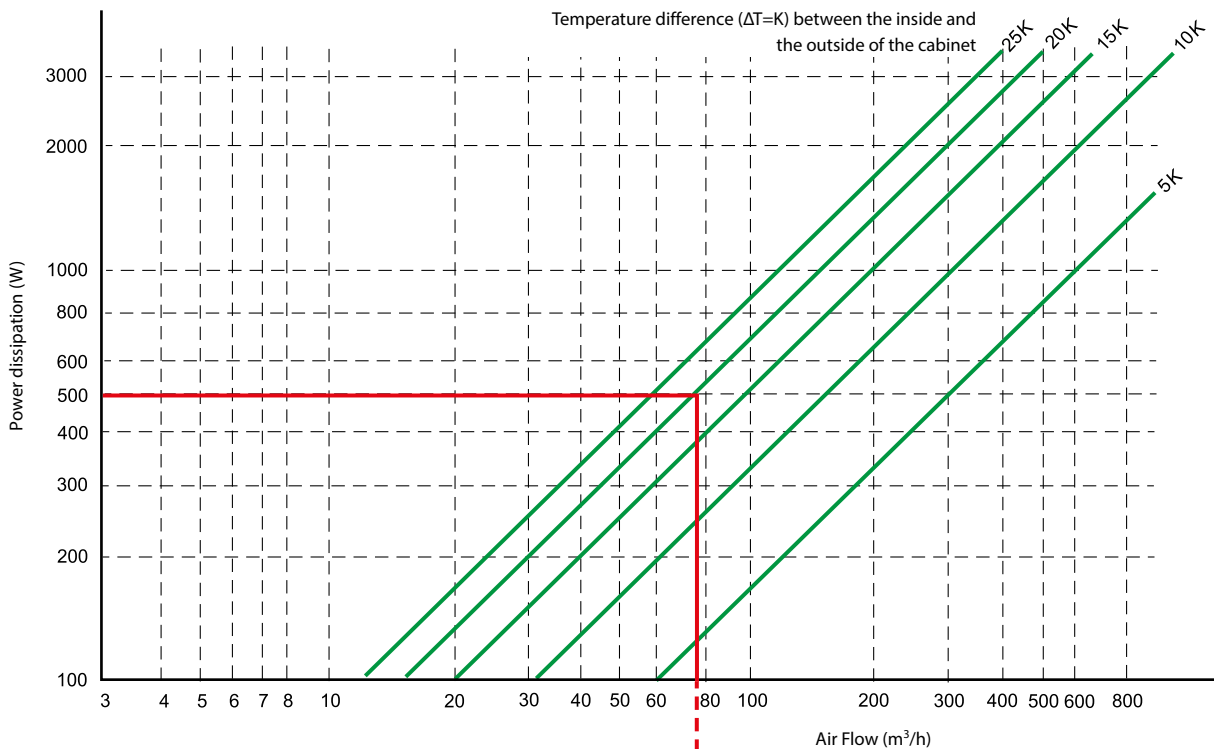

G

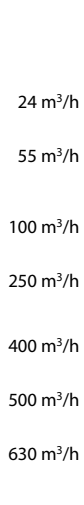

### Example

First, estimate the power dissipated within the cabinet. Then calculate the maximum difference between the internal and external temperature (green lines) by considering the difference between the maximum permitted internal temperature (as dictated by the temperature rating of the enclosed components, or specification) and the maximum temperature expected outside the cabinet.

The projection onto the X axis, of the intersection between the power (watts) and the appropriate green line, corresponds to the air flow rate in m<sup>3</sup>/h required to meet the maximum internal temperature limit. Extending this line vertically to intersect with the blue horizontal lines, indicates the most appropriate model of 7F fan to be fitted to the cabinet to provide the requisite air flow.

The example above considers a cabinet with an internal thermal power dissipation of 500 W, and assumes the maximum temperature difference between the inside and the outside of the cabinet to be 20K. The required air flow can be seen to be a little less than 80 m<sup>3</sup>/h.

It is suggested that this is increased by 10% to allow for the affects of a dirty filter.

And so, it can be seen that models of the 7F with 100 m<sup>3</sup>/h flow rate will provide the proper dissipation of heat under these circumstances.

## Application notes

### Filter Fan

The ball-bearing axial fan housing is made of aluminium and the rotor is made of plastic or metal (depending on the type).

### Filter classes

Within EN 779 are specified 9 filter classes, categorised into 4 coarse dust filters and 5 fine dust filters.

The coarse dust filters G1 - G4 are able to filter particles > 10 µm and the fine dust filters G5 - G9 are able to filter particles from (1...10)µm.

Filter classes	Example of particle	Particle size
G1 - G4 (EU1 - EU4)	Textile fibers, hair, sand, pollen, spores, insects, cement dust	> 10 µm
G5 - G9 (EU5 - EU9)	Pollen, spores, cement dust, tobacco smoke, oil smoke, soot	(1...10)µm

### Filtering degree (Am)

The degree of filtering (Am) is the percentages of dust, by weight, that is caught and retained by the filter.

### Filter mats

The quality of these filter mats has been independently tested, according to EN 779 and branded after passing the test.

The filter mats are to filter class G3 or G4 and have an average filtering degree of (80...90)%.

### Filter material

The filter material consists of a synthetic fiber with progressive construction which is moisture-resistant to 100% RH and temperature resistant to +100 °C.

According to the strict requirements of fire class F1, DIN 53438, these filter mats are self-extinguishing.

### Progressive construction at filter mats

The individual fibers of these filter mats are bonded by a special process to provide a progressive construction where the fiber size and spacing varies through the thickness of the filter mat.

This means that coarse dust particles are caught early and fine dust later through the thickness of the mat. In this way the entire depth of the filter mat is used.

### Flammability class of the housing and the cover

The plastic materials used comply with flammability class V-0, according to UL94.

### Filter Fan in "reverse flow" version

As supplied, the standard Filter Fan is in "Draw-In"- mode, which means that cool air is filtered and drawn into the cabinet. In some cases it may be required that the warm air is blown out of the cabinet.

In which case it is possible to get Filter Fans in "Exhaust Filter" mode version (7F.21 or 7F.31).

### Mounting of the pressure compensation device

In sealed cabinets and enclosures the internal pressure can vary due to changes in temperature. The pressure compensation device (07F.80) will relieve this internal/external pressure differential whilst maintaining a high level of protection - preventing the ingress of dust and moisture into the cabinet or the enclosure. The pressure compensation device is approved for use in cabinets and enclosures according to DIN EN 62208.

Drill a hole Ø 37<sup>+1.0</sup> mm in the housing wall and fix the pressure compensation device with the accompanying nut. It is important to ensure that the sealing ring is located on the outside. To ensure optimum pressure balance, it is recommended to fit 2 pressure compensation devices at the upper sides of the cabinet or enclosure.





# Panel Heaters

## 25 - 50 - 100 - 150 - 250 - 400 W

7H  
SERIES



Drying kilns



Hoists and cranes



Road / tunnel  
lighting



Plastic  
moulding  
machines



Automatic  
car-washes



Panels for  
electrical  
distribution



Control panels



Forced-air  
ventilators

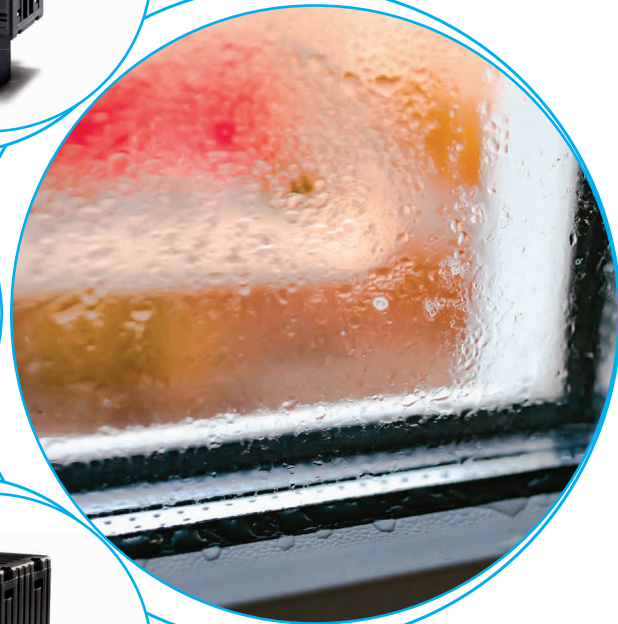





**Panel heaters**

**Type 7H.51.0.230.0025**

- Heating power 25 W

**Type 7H.51.0.230.0050**

- Heating power 50 W

- Nominal voltage (110...230)V AC/DC
- Safe touch
- PTC resistor, self regulating heating system
- Clip for 35 mm rail (EN 60715) mount

7H.51.0025/0050  
Screw terminal



**7H.51.0.230.0025**



- Heating power 25 W
- Nominal voltage (110...230)V AC/DC
- Safe touch

**7H.51.0.230.0050**



- Heating power 50 W
- Nominal voltage (110...230)V AC/DC
- Safe touch

\* At 20°C ambient temperature  
\*\* Except upper protection grille

For outline drawings see page 7

**Heating specification**

Heating power *	W	25	50
Heater		PTC resistor, self-regulating heating system	
Surface temperature**	°C	≤ 100	≤ 100
Housing		Plastic according to UL94 - V0, black	

**Supply specification**

Nominal voltage (U <sub>N</sub> )	V AC (50/60 Hz)/DC	110...230	110...230
Rated current	A	0.13	0.20
Operating range	V AC/DC	88...253	88...253

**Technical data**

Radiator		Alluminium profile	
Electrical connection		Screw terminals	
Fitting position		Vertical	
Ambient temperature	°C	-45...+50	-45...+50
Protection category		IP 20	IP 20

**Approvals** (according to type)



**Panel heaters**

**Type 7H.51.0.230.0100**

- Heating power 100 W

**Type 7H.51.0.230.0150**

- Heating power 150 W

- Nominal voltage (110...230)V AC/DC
- Safe touch
- PTC self regulating heating system
- Clip for 35 mm rail (EN 60715) mount

7H.51.0100/0150  
Screw terminal



**7H.51.0.230.0100**



- Heating power 100 W
- Nominal voltage (110...230)V AC/DC
- Safe touch

**7H.51.0.230.0150**



- Heating power 150 W
- Nominal voltage (110...230)V AC/DC
- Safe touch

G

\* At 20°C ambient temperature

\*\* Except upper protection grille

For outline drawings see page 8

**Heating specification**

Heating power *	W	100	150
Heater		PTC resistor, self-regulating heating system	
Surface temperature**	°C	≤ 80	≤ 80
Housing		Plastic according to UL94 – V0, black	

**Supply specification**

Nominal voltage (U <sub>N</sub> )	V AC (50/60 Hz)/DC	110...230	110...230
Rated current	A	0.45	0.70
Operating range	V AC/DC	88...253	88...253

**Technical data**

Radiator		Alluminium profile	
Electrical connection		Screw terminals	
Fitting position		Vertical	
Ambient temperature	°C	-45...+50	-45...+50
Protection category		IP 20	IP 20

**Approvals** (according to type)



**Panel heaters fan assisted**

**Type 7H.51.8.xxx.0250**

- Heating power 250 W

**Type 7H.51.8.xxx.0400**

- Heating power 400 W

- Nominal voltage 110 or 230 V AC
- Safe touch
- PTC resistor, self regulating heating system
- Fast wiring terminals
- Clip for 35 mm rail (EN 60715) mount

7H.51.0250/0400  
Push-in terminal



**NEW 7H.51.8.xxx.0250**



- Heating power 250 W
- Nominal voltage 110 or 230 V AC
- Fan assisted

**NEW 7H.51.8.xxx.0400**



- Heating power 400 W
- Nominal voltage 110 or 230 V AC
- Fan assisted

\* At 20°C ambient temperature  
\*\* Except upper protection grille

For outline drawings see page 8

Heating specification					
Heating power *	W	250		400	
Heater		PTC resistor, self-regulating heating system			
Surface temperature**	°C	≤ 30		≤ 30	
Air flow rate	m <sup>3</sup> /h	30			
Fan - Life time at 25 °C	h	50 000		50 000	
Housing		Plastic according to UL94 – V0, black			
Supply specification					
Nominal voltage (U <sub>n</sub> )	V AC (50/60 Hz)	110	230	110	230
Rated current	A	2	1	3	1.7
Operating range	V AC	88...121	184...253	88...121	184...253
Technical data					
Radiator		Alluminium profile			
Electrical connection		Screwless terminal			
Fitting position		Vertical			
Ambient temperature	°C	-40...+50		-40...+50	
Protection category		IP 20		IP 20	
<b>Approvals</b> (according to type)					

## Ordering information

Example: 7H series, Panel heaters, heating power 50 W, 110...230 V AC/DC.

**7 H . 5 1 . 0 . 2 3 0 . 0 0 5 0**

**Series**

**Type**

51 = Panel heaters safe touch

**Supply version**

0 = AC (50/60 Hz)/DC

8 = AC (50/60 Hz) only fan assisted version

**Supply voltage**

230 = 110...230 V

110 = 110 V only fan assisted version

230 = 230 V only fan assisted version

**Heater power**

0025 = 25 W

0050 = 50 W

0100 = 100 W

0150 = 150 W

0250 = 250 W

0400 = 400 W

## General data

Insulation		7H.51.0...025/050/100/150	7H.51.8...250/400
Rated voltage of power supply system	V AC	120/240	240
Rated insulations voltage	V AC	250	
Pollution degree		3	
Terminal insulation			
Dielectric strenght between L and N to metal clip on the housing	V AC (3s)	2500	
Overvoltage category		II	
Rated impulse voltage (1.2/50) $\mu$ s	kV	2.5	
Terminals		solid cable	stranded cable
Max. wire size (push-in terminals)	mm <sup>2</sup>	2 x 1.5	2 x 1.5
	AWG	2 x 16	2 x 16
Max. wire size (screw terminals)	mm <sup>2</sup>	1 x 2.5	1 x 1.5
	AWG	1 x 12	1 x 16
Screw torque	Nm	0.5	

## Wiring diagrams

### Fan assisted version

7T.81.0.000.240x

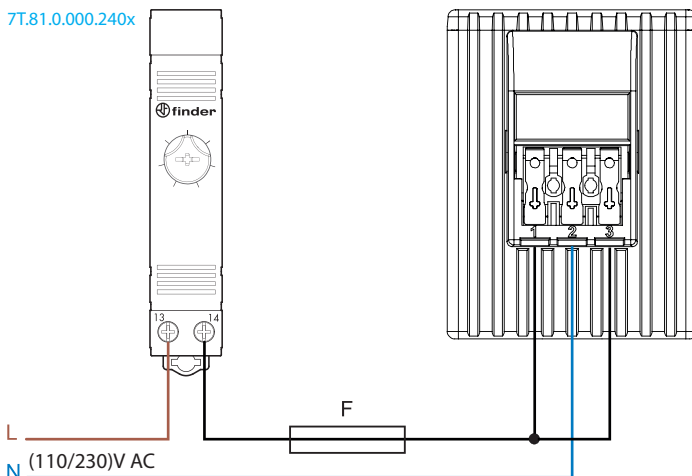

**NOTE:** Separate supply (L) terminals for the heater and the internal fan allow them to be powered independently.

So, dependent on the specific situation, the installer might wish the heating element to be controlled by an upstream thermostat but require the fan to run continuously (although the latter will significantly reduce the product's life).

1 = L (heater)

2 = N

3 = L (fan)

F = aM 10 A @110 V AC  
aM 6.3 A @230 V AC

## Wiring diagrams

NOT Fan assisted versions

AC version

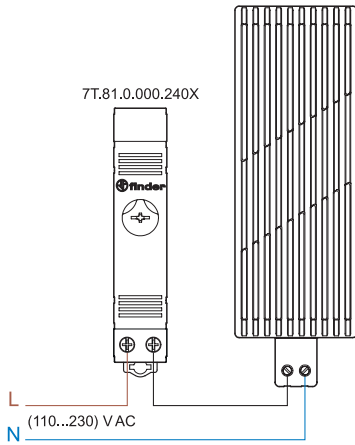

DC version

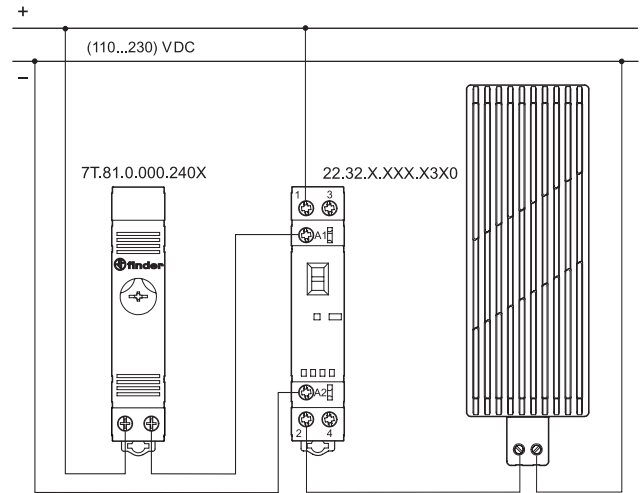

### SAFETY NOTE

For reasons of safety and performance, heaters must be mounted in the following way:

1. keep a distance of 100 mm. from components above and below and of 60 mm from side components
2. install vertically (cables below heater) in the bottom part of cabinet
3. do not mount heaters over easily inflammable materials
4. do not operate in corrosive ambient air

### WARNING

Do not cover the heater.

The 7H.51 Heater surface is very hot for 15-20 minutes after disconnecting.

During working and maintenance, don't touch it.

**Caution:** risk of burns, temperatur of the side less than +100 °C..

## Outline drawings

Type 7H.51.0025  
Screw terminal

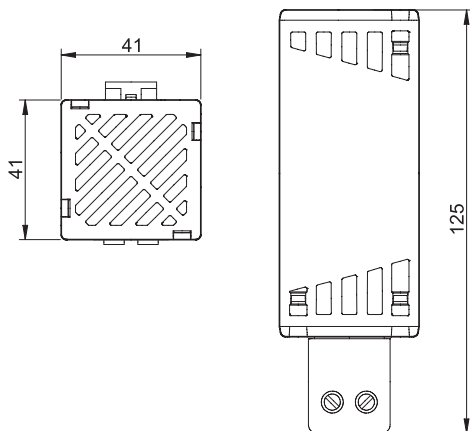

Type 7H.51.0050  
Screw terminal

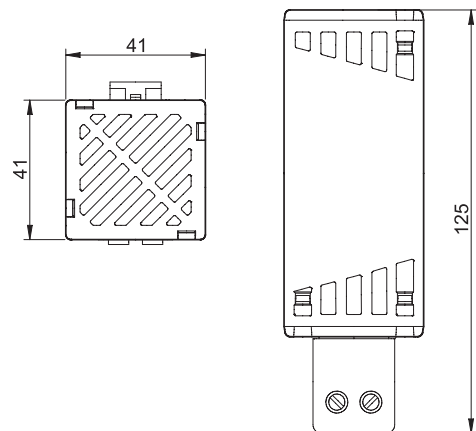

Outline drawings

Type 7H.51.0100  
Screw terminal



Type 7H.51.0150  
Screw terminal

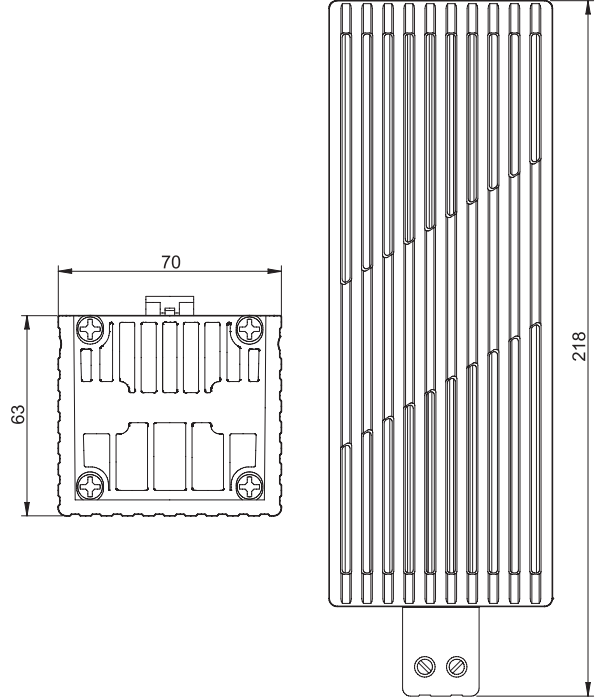
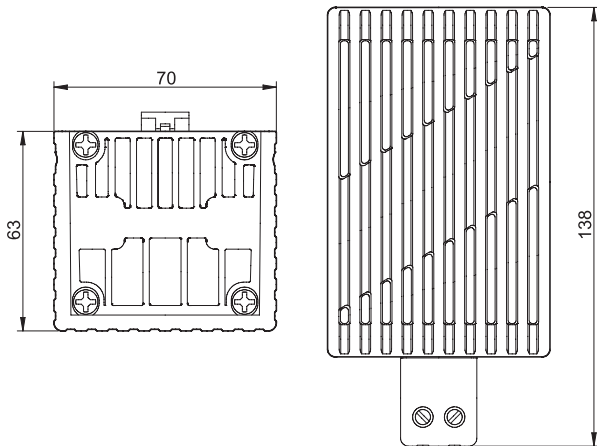

G

Types 7H.51.0250 / 0400  
Push-in terminal

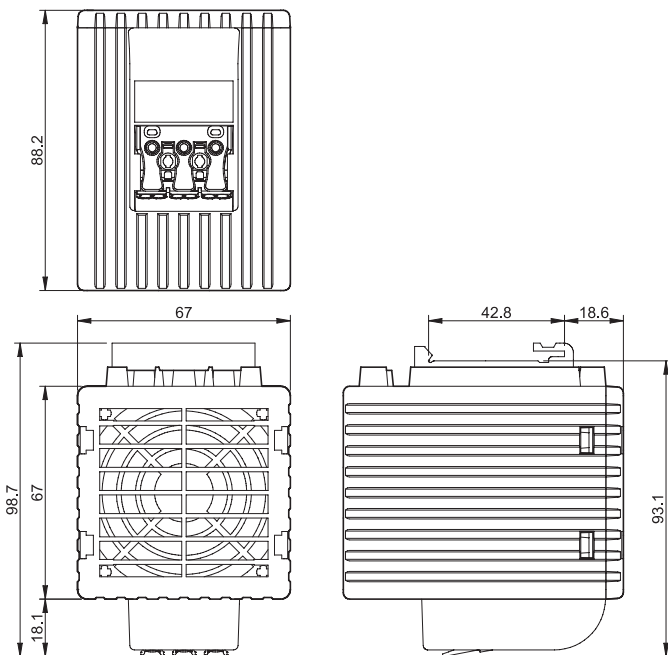

# LED panel light

7L  
SERIES



Panels for  
electrical  
distribution



Control panels







**LED light for electrical panels**

**Type 7L.43.0.xxx.0x00**

- 600 lumens

**Type 7L.46.0.xxx.0x00**

- 1200 lumens

- Direct magnetic mounting or through a screw-fixed metallic support
- Low power consumption
- Radiation angle 120°
- Colour temperature 5000 K
- Push-in terminals for the connection to a single unit
- Plug-in terminals for the connection to a single or multiple units (up to 7 lamps)
- Design by Minelli - Fossati

**7L.43.0.xxx.0x00**



- 600 lumens, 6 W
- Without ON/OFF switch or movement detector

**NEW 7L.46.0.xxx.0x00**



- 1200 lumens, 9 W
- Without ON/OFF switch or movement detector

For outline drawing see page 8

**Lamp Data**

Type of lamp LED, viewing angle 120°, Light colour: daylight white, colour temperature: 5000 K

Luminous flux	lm	600	1200
---------------	----	-----	------

Life time	h	60 000	
-----------	---	--------	--

**Electrical Data**

Operating voltage	V AC (50/60 Hz)/DC	12...48 - 110...240	
-------------------	--------------------	---------------------	--

Operating range	V AC/DC	9.6...52.8 - 88...264	
-----------------	---------	-----------------------	--

Nominal current @230 V AC	mA	39	54
---------------------------	----	----	----

Nominal current @24 V DC	mA	200	300
--------------------------	----	-----	-----

Rated power of the lamp @230 V AC	W	6	9
-----------------------------------	---	---	---

Rated power of the lamp @24 V DC	W	6	9
----------------------------------	---	---	---

**General data**

Connection cable to the lamp	Sheathed cable 2 x 1.5 mm <sup>2</sup> , flexible with push-in or socket
------------------------------	--

Interconnectors from lamp to lamp	Sheathed cable 2 x 1.5 mm <sup>2</sup> , flexible with plug and socket
-----------------------------------	--

Socket and plug	2-pole with interlock
-----------------	-----------------------

Type of mounting	Magnetic or clip fixing
------------------	-------------------------

Housing	Plastic, transparent
---------	----------------------

Ambient temperature	°C	-30...+55
---------------------	----	-----------

Protection class	II
------------------	----

Protection category	IP 20
---------------------	-------

**Approvals** (according to type)



## LED light for electrical panels

## Type 7L.43.0.xxx.1x00

- 600 lumens

## Type 7L.46.0.xxx.1x00

- 1200 lumens

- Direct magnetic mounting or through a screw-fixed metallic support
- Low power consumption
- Radiation angle 120°
- Colour temperature 5000 K
- Push-in terminals for the connection to a single unit
- Plug-in terminals for the connection to a single or multiple units (up to 7 lamps)
- Design by Minelli - Fossati

## 7L.43.0.xxx.1x00



- 600 lumens, 6 W
- With ON/OFF switch

## 7L.46.0.xxx.1x00



- 1200 lumens, 9 W
- With ON/OFF switch

For outline drawing see page 9

## Lamp Data

Type of lamp

LED, viewing angle 120°, Light colour: daylight white, colour temperature: 5000 K

Luminous flux

lm

600

1200

Life time

h

60 000

## Electrical Data

Operating voltage

V AC (50/60 Hz)/DC

12...48 - 110...240

Operating range

V AC/DC

9.6...52.8 - 88...264

Nominal current @230 V AC

mA

39

54

Nominal current @24 V DC

mA

200

300

Rated power of the lamp @230 V AC

W

6

9

Rated power of the lamp @24 V DC

W

6

9

## General data

Connection cable to the lamp

Sheathed cable 2 x 1.5 mm<sup>2</sup>, flexible with push-in or socket

Interconnectors from lamp to lamp

Sheathed cable 2 x 1.5 mm<sup>2</sup>, flexible with plug and socket

Socket and plug

2-pole with interlock

Type of mounting

Magnetic or clip fixing

Housing

Plastic, transparent

Ambient temperature

°C

-30...+55

Protection class

II

Protection category

IP 20

Approvals (according to type)



**LED light for electrical panels**

**Type 7L.43.0.xxx.2x00**

- 600 lumens

**Type 7L.46.0.xxx.2x00**

- 1200 lumens

- Direct magnetic mounting or through a screw-fixed metallic support
- Low power consumption
- Radiation angle 120°
- Colour temperature 5000 K
- Push-in terminals for the connection to a single unit
- Plug-in terminals for the connection to a single or multiple units (up to 7 lamps)
- Design by Minelli - Fossati

**7L.43.0.xxx.2x00**



- 600 lumens, 6 W
- With movement detector

**7L.46.0.xxx.2x00**



- 1200 lumens, 9 W
- With movement detector

For outline drawing see page 10

**Lamp Data**

Type of lamp LED, viewing angle 120°, Light colour: daylight white, colour temperature: 5000 K

Luminous flux	lm	600	1200
Life time	h	60 000	
Light ON time after last detection	min	3	

**Electrical Data**

Operating voltage	V AC (50/60 Hz)/DC	12...48 - 110...240	
Operating range	V AC/DC	9.6...52.8 - 88...264	
Nominal current @230 V AC	mA	39	54
Nominal current @24 V DC	mA	200	300
Rated power of the lamp @230 V AC	W	6	9
Rated power of the lamp @24 V DC	W	6	9

**General data**

Connection cable to the lamp	Sheathed cable 2 x 1.5 mm <sup>2</sup> , flexible with push-in or socket
Interconnectors from lamp to lamp	Sheathed cable 2 x 1.5 mm <sup>2</sup> , flexible with plug and socket
Socket and plug	2-pole with interlock
Type of mounting	Magnetic or clip fixing
Housing	Plastic, transparent
Ambient temperature	°C -30...+55
Protection class	II
Protection category	IP 20

**Approvals** (according to type)



## Ordering information

Example: Series 7L, LED light with magnetic fixing, ON/OFF switch, supply voltage 12...48V AC/DC and push-in terminals.

7 L . 4 3 . 0 . 0 2 4 . 1 1 0 0

**Series** \_\_\_\_\_

**Type** \_\_\_\_\_  
 43 = LED lamp 600 lumens  
 46 = LED lamp 1200 lumens

**Supply version** \_\_\_\_\_  
 0 = AC (50/60 Hz)/DC

**Supply voltage** \_\_\_\_\_  
 024 = (12...48)V AC/DC  
 230 = (110...240)V AC/DC

**Connections**  
 1 = Push-in terminals for the connection to a single unit  
 2 = Plug-in terminals for the connection to a single or multiple units

**Switching**  
 0 = Without ON/OFF switch or movement detector  
 1 = Switching via ON/OFF switch  
 2 = Switching via movement detector

### All types

7L.43.0.024.0100	7L.46.0.024.0100
7L.43.0.024.0200	7L.46.0.024.0200
7L.43.0.024.1100	7L.46.0.024.1100
7L.43.0.024.1200	7L.46.0.024.1200
7L.43.0.024.2100	7L.46.0.024.2100
7L.43.0.024.2200	7L.46.0.024.2200
7L.43.0.230.0100	7L.46.0.230.0100
7L.43.0.230.0200	7L.46.0.230.0200
7L.43.0.230.1100	7L.46.0.230.1100
7L.43.0.230.1200	7L.46.0.230.1200
7L.43.0.230.2100	7L.46.0.230.2100
7L.43.0.230.2200	7L.46.0.230.2200

### Accessories



07L.11 (included in the box)



07L.12 (not included)

0 7 L . 1 1

Type

Sockets and plugs, coded, for connection to a 2-pole cable (2 x 1.5 mm<sup>2</sup>), e.g. H05VV-F, 2 x 1.5 mm<sup>2</sup>

11 = Socket, loose for output side

12 = Plug, loose for input side

### Outline drawings

Type 07L.11

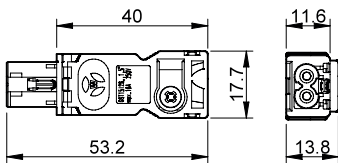

Type 07L.12

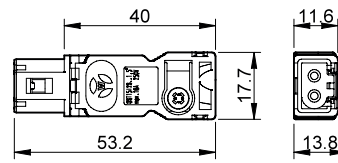

### Connections

Quick and simple wiring system via **push-in terminals** for the connection to a single unit, or via **plug-in terminals** for the connection to a single or multiple units.

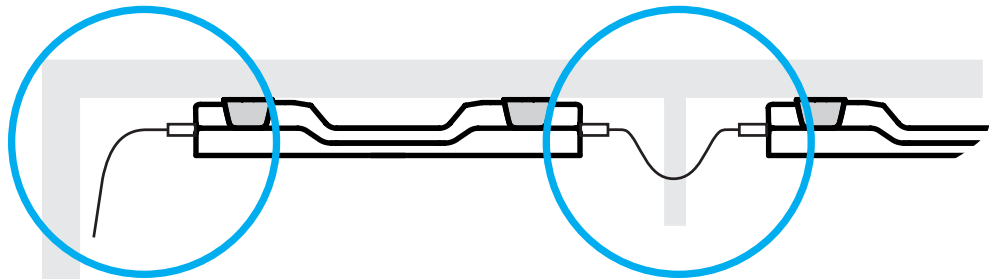

Multiple connection (up to 7 lamps)

G

Outline drawings

Types 7L.4x.0.xxx.0100/0200

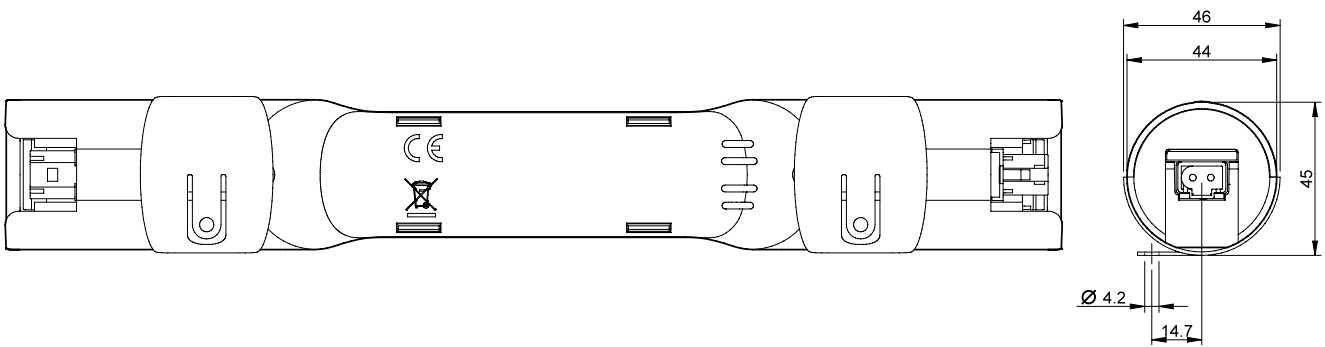
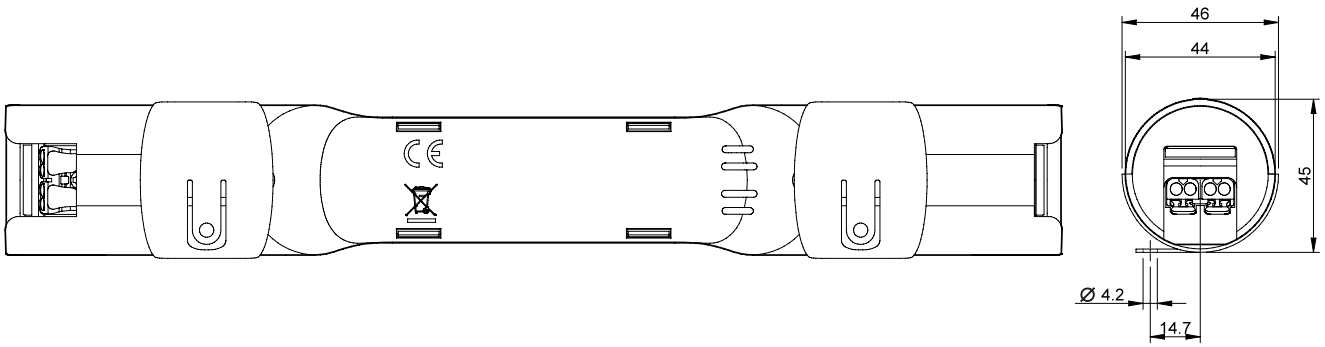

G

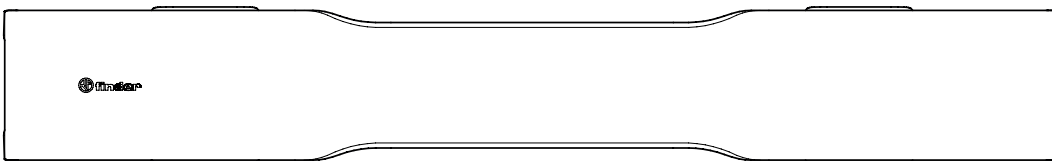
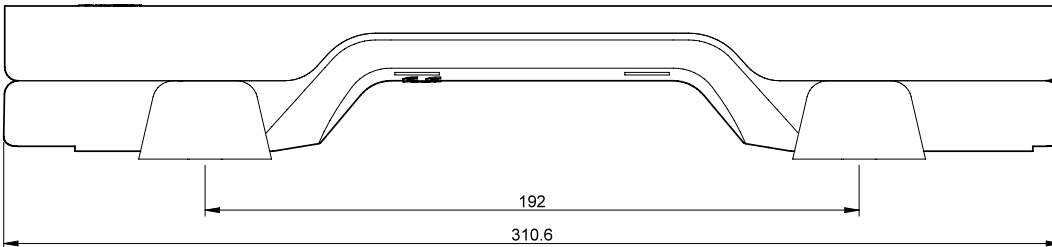

### Outline drawings

Types 7L.4x.0.xxx.1100 / 1200

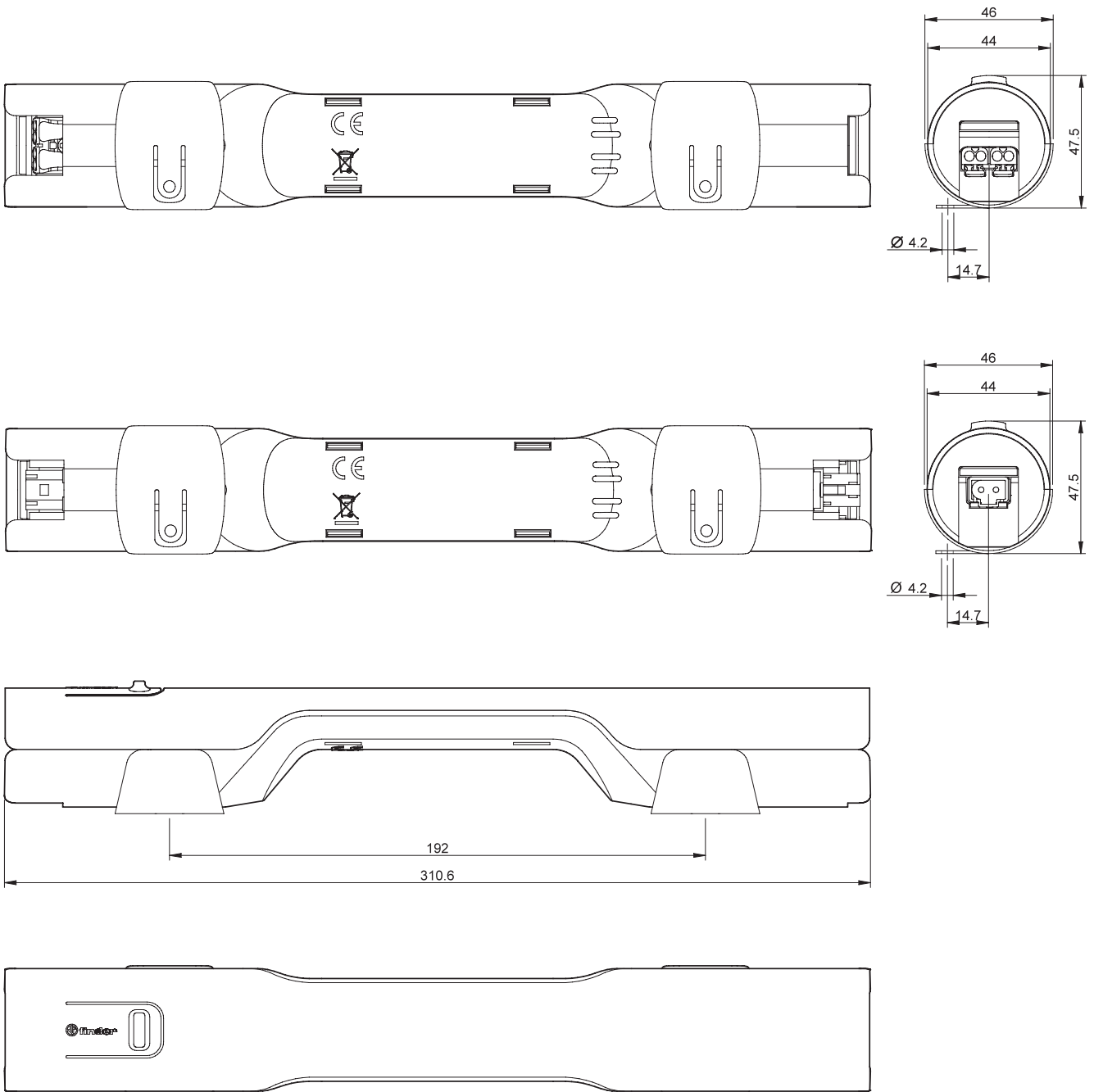

G

### Outline drawings

Types 7L.4x.0.xxx.2100 / 2200

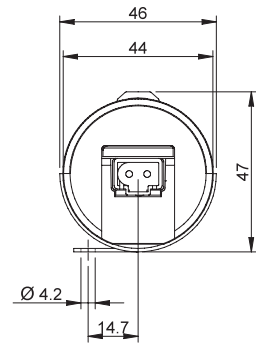
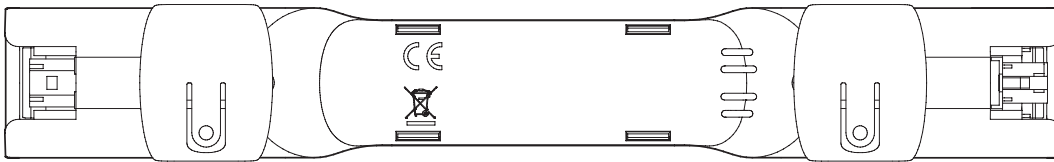
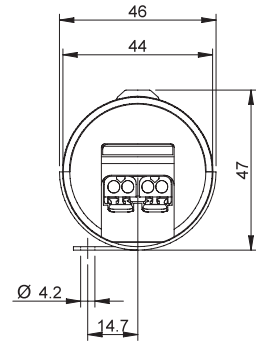
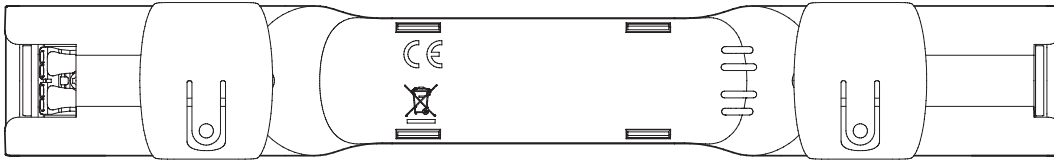

G

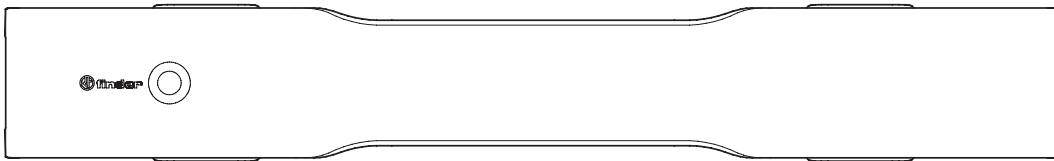
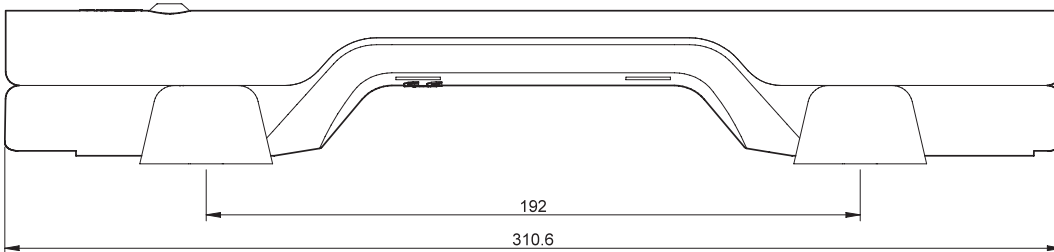



# Power outlets for electrical enclosures

7U  
SERIES



Panels for electrical distribution



Control panels

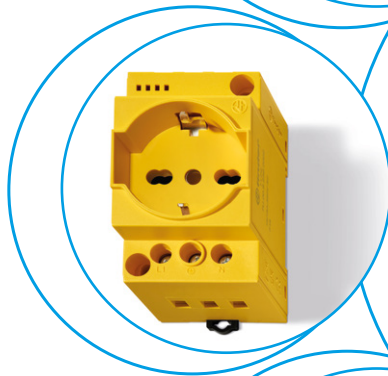



**Power outlets for electrical enclosures**

**Type 7U.00.8.230.00x0**

- Grey

**Type 7U.00.8.230.00x2**

- Yellow

- Available with or without voltage presence LED in socket
- Compatible with Schuko and Italian Bipasso
- Up to 16 A
- Panel or rail 35mm (EN 60715) mounting

7U.00

Screw terminals



**7U.00.8.230.00x0**



- Grey color RAL 7035
- Schuko + Italian Bipasso  
10/16 A

**7U.00.8.230.00x2**



- Yellow color RAL 1021  
(see Safety Notes)
- Schuko + Italian Bipasso  
10/16 A

For outline drawing see page 6

**Supply specifications**

Nominal voltage (U <sub>N</sub> )	V AC (50/60 Hz)	230	230
Nominal current (I <sub>N</sub> )	A	16	16
<b>Technical data</b>			
Electrical connection	Screw terminals		
Ambient temperature	°C	-40...+70	-40...+70
Environmental protection		II	II
Protection category		IP 20	IP 20
<b>Approvals (according to type)</b>			

**Power outlets for electrical enclosures**

**Type 7U.01.8.230.00x0**

- Grey

**Type 7U.01.8.230.00x2**

- Yellow

- Available with or without voltage presence LED in socket
- Compatible with French type
- Up to 16 A
- Panel or rail 35mm (EN 60715) mounting

7U.01

Screw terminals



**NEW 7U.01.8.230.00x0**



- Grey color RAL 7035
- French system 16 A

**NEW 7U.01.8.230.00x2**



- Yellow color RAL 1021 (see Safety Notes)
- French system 16 A

G

For outline drawing see page 6

**Supply specifications**

Nominal voltage (U <sub>N</sub> )	V AC (50/60 Hz)	230	230
Nominal current (I <sub>N</sub> )	A	16	16

**Technical data**

Electrical connection	Screw terminals		
Ambient temperature	°C	-40...+70	-40...+70
Environmental protection		II	II
Protection category		IP 20	IP 20

**Approvals** (according to type)



## Ordering information

Example: 7U Series, socket for the cabinet, grey color, schuko + Italian Bipasso, 230 V AC, with voltage presence LED.

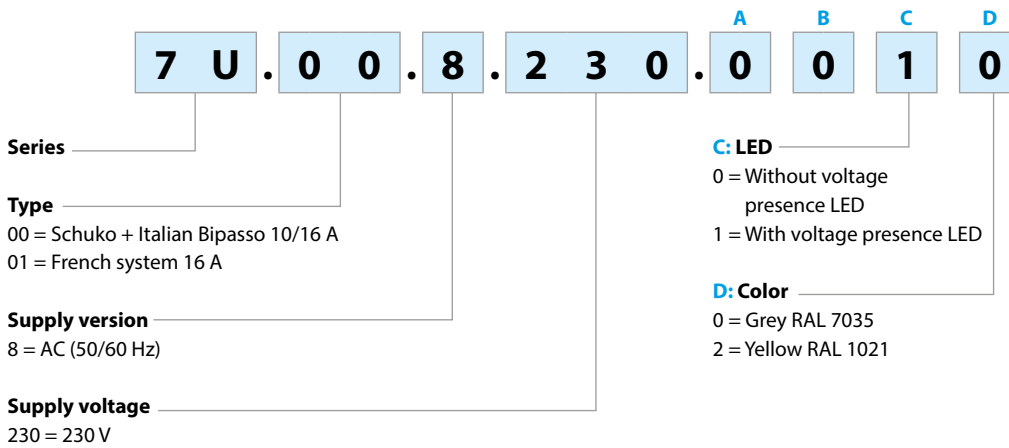

## General data

Terminal insulation		solid cable	stranded cable
Max. wire size	mm <sup>2</sup>	1 x 10 / 2 x 6	1 x 10 / 2 x 6
	AWG	1 x 8 / 2 x 10	1 x 8 / 2 x 10
Min. wire size	mm <sup>2</sup>	1 x 0.5	1 x 0.5
	AWG	1 x 20	1 x 20
Wire strip length	mm	9	
Screw torque	Nm	0.5	

## Wiring diagrams

### Type 7U.0x

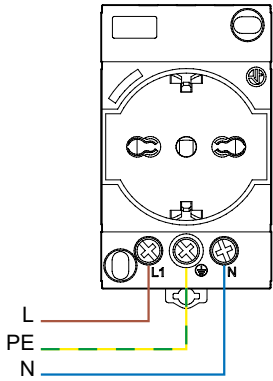

### Electric shock hazard

#### Safety notes

Any equipment within an electrical system that remains live after turning off at the main switch, must be marked in compliance with standards DIN VDE 0105-1 and IEC 204-1 / EN 60204-1 / DIN VDE 0113 Part 1, as well as the VBG 4 accident prevention regulations.

For these applications use the yellow power outlet.

## Outline drawing

Type 7U.0x  
Screw terminals

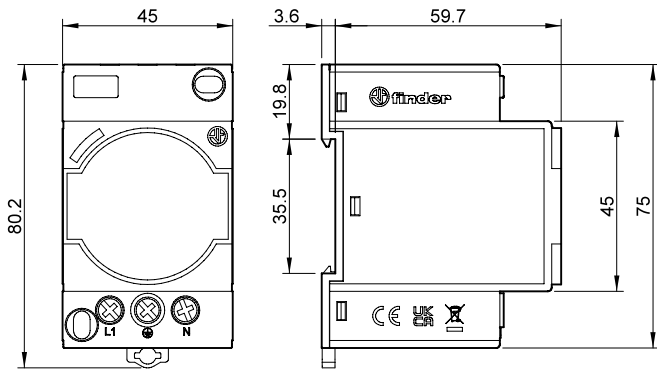

# High Current Terminal Blocks

9D  
SERIES



Panels for electrical distribution



Control panels



Cabinets junction boxes

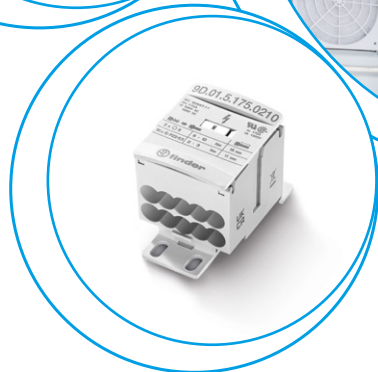
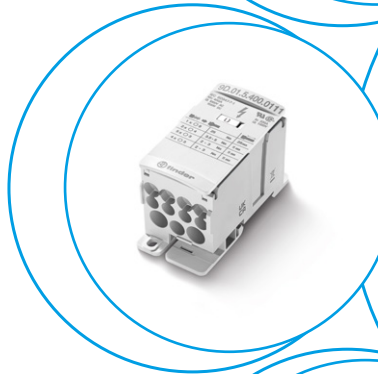





### High current distribution terminal blocks for electrical panels

**Type 9D.01.5.080.0304**  
- 80 A

**Type 9D.01.5.125.0206**  
- 125 A

**Type 9D.01.5.175.0210**  
- 175 A

#### 3 configurations available in a single product:

- Single, pole splitter: Split of main power input into 4, 6, 10 or 11 outputs
- Multiple, pole splitters: Splitting with increased number of outputs
- Grouping: Combining several inputs to make a single output (eg. solar applications)
- Reversible snap-on cover
- For use with Cu + AL cables
- Ratings, approvals and screw torque settings marked on cover
- Plastic material conforming to UL94 V0
- Ready to use Marking Kit (L1, L2, L3, N, PE, +, -) supplied with every block
- Adjacent units may be mechanically interlocked, if required
- 35 mm din rail (EN60715) mounting

For outline drawing see page 6

#### Current specification

Max current	A	80	125	175
Rated voltage	V AC/DC	1000/1500	1000/1500	1000/1500
Rated impulse voltage	kV	8	8	8
Short-time withstand current (I <sub>cw</sub> 1s)	A	1920	4200	6000
Short Circuit Current Rating (SCCR)	kA	100	100	100
Rated peak withstand current (I <sub>pk</sub> )	kA	27	30	30

#### Input wire specification (Solid/Stranded)

Number of input		3	1	2
Terminal diameter	Ømm	6.6	9.8	11.8
Min. wire size	mm <sup>2</sup>	2.5	10	10
	AWG	14	8	6
Max. wire size	mm <sup>2</sup>	16	35	70
	AWG	6	2	2/0
Wire input stripping length	mm	15	15	15
Tool		Posidriv - flat screwdriver	Allen Key	Allen Key
Tool dimension	mm	5.5/PZ2	4	5
Torque	Nm	1.5...2	3.5...5	6...10

#### Output wire specification (Solid/Stranded)

Number of outputs		4	1	6	10
Terminal diameter	Ømm	4.5	6.8	6.4	6.4
Min. wire size	mm <sup>2</sup>	2.5	6	2.5	2.5
	AWG	14	10	14	14
Max. wire size	mm <sup>2</sup>	6	16	16	16
	AWG	10	6	6	6
Wire output stripping length	mm	11	11	11	11
Tool		Posidriv - flat screwdriver	Allen Key	Posidriv - flat screwdriver	Posidriv - flat screwdriver
Tool dimension	mm	4/PZ1	3	5.5/PZ2	5.5/PZ2
Torque	Nm	0.8...12	2...3	2...3	2...3

#### General data

Ambient temperature	°C	-20...+70	-20...+70	-20...+70
Protection category	IEC	IP 20	IP 20	IP 10
Protection category	UL	NEMA 1	NEMA 1	NEMA 1

**Approvals** (according to type)



**NEW** 9D.01.5.080.0304



- 80 A
- 7 connections

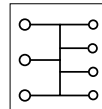

**NEW** 9D.01.5.125.0206



- 125 A
- 8 connections

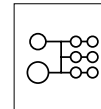

**NEW** 9D.01.5.175.0210



- 175 A
- 12 connections

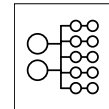

**High current distribution terminal blocks for electrical panels**

**Type 9D.01.5.250.0111**  
- 250 A

**Type 9D.01.5.400.0111**  
- 400 A

**3 configurations available in a single product:**

- Single, pole splitter: Split of main power input into 4, 6, 10 or 11 outputs
- Multiple, pole splitters: Splitting with increased number of outputs
- Grouping: Combining several inputs to make a single output (eg. solar applications)
- Reversible snap-on cover
- For use with Cu + AL cables
- Ratings, approvals and screw torque settings marked on cover
- Plastic material conforming to UL94 V0
- Ready to use Marking Kit (L1, L2, L3, N, PE, +, -) supplied with every block
- Adjacent units may be mechanically interlocked, if required
- 35 mm din rail (EN60715) mouting

For outline drawing see page 6

**NEW** 9D.01.5.250.0111



- 250 A
- 12 connections

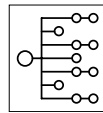

**NEW** 9D.01.5.400.0111



- 400 A
- 12 connections

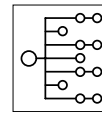

**Current specification**

Max current	A	250	400
Rated voltage	V AC/DC	1000/1500	1000/1500
Rated impulse voltage	kV	8	8
Short-time withstand current (I <sub>cw</sub> 1s)	A	11400	18000
Short Circuit Current Rating (SCCR)	kA	100	100
Rated peak withstand current (I <sub>pk</sub> )	kA	51	51

**Input wire specification (Solid/Stranded)**

Number of input		1	1
Terminal diameter	Ømm	15.3	15.3
Min. wire size	mm <sup>2</sup>	35	95
	AWG	2	3/0
Max. wire size	mm <sup>2</sup>	120	185
	AWG	250 Kcmil	400 Kcmil
Wire input stripping length	mm	28	28
Tool		Allen Key	Allen Key
Tool dimension	mm	6	8
Torque	Nm	19...21	25

**Output wire specification (Solid/Stranded)**

Number of outputs		2	5	4	2	5	4
Terminal diameter	Ømm	8.7	6.4	5.7	8.7	6.4	5.7
Min. wire size	mm <sup>2</sup>	2.5	2.5	2.5	2.5	2.5	2.5
	AWG	14	14	14	14	14	14
Max. wire size	mm <sup>2</sup>	35	16	10	35	16	10
	AWG	2	6	8	2	6	8
Wire output stripping length	mm	11			11		
Tool		Allen Key			Allen Key		
Tool dimension	mm	4	3		4	3	
Torque	Nm	3.5...5	2...3		3.5...5	2...3	

**General data**

Ambient temperature	°C	-20...+70		-20...+70	
Protection category	IEC	IP 10		IP 10	
Protection category	UL	NEMA 1		NEMA 1	

**Approvals (according to type)**



### Ordering information

Example: 9D Series, High current terminal block, nominal current 175 A, 12 connections.

**9 D . 0 1 . 5 . 1 7 5 . 0 2 1 0**

**Series**  
**Type**  
01 = Terminal blocks  
**Supply version**  
5 = Current  
**Maximum Current**  
080 = 80 A  
125 = 125 A  
175 = 175 A  
250 = 250 A  
400 = 400 A

**Number of inputs**  
01 = 1 input  
02 = 2 inputs (1+1)  
- 9D.01.5.125.0206  
2 inputs  
- 9D.01.5.175.0210  
03 = 3 inputs

**Number of output**  
04 = 4 outputs  
06 = 6 outputs  
10 = 10 outputs  
11 = 11 outputs

**All types**  
9D.01.5.080.0304  
9D.01.5.125.0206  
9D.01.5.175.0210  
9D.01.5.250.0111  
9D.01.5.400.0111

### Wiring examples\*

Single, pole splitter application. Main power input splits into three outputs.

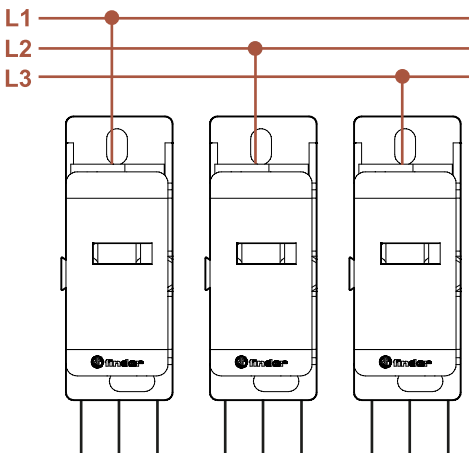

Multiple, pole splitter application: Main power input split into six outputs.

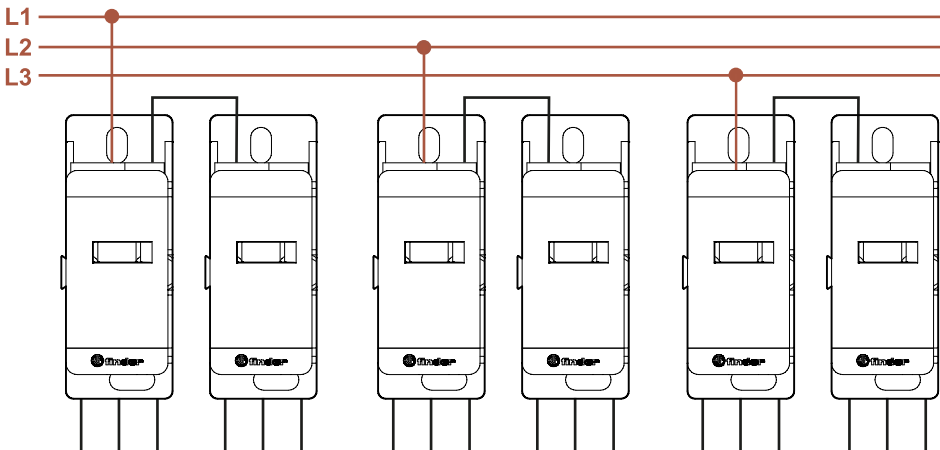

\* These are connection examples.  
The current capacity of each conductor must comply with the appropriate IEC, UL or CSA standard.

Outline drawings

Type 9D.01.5.080.0304

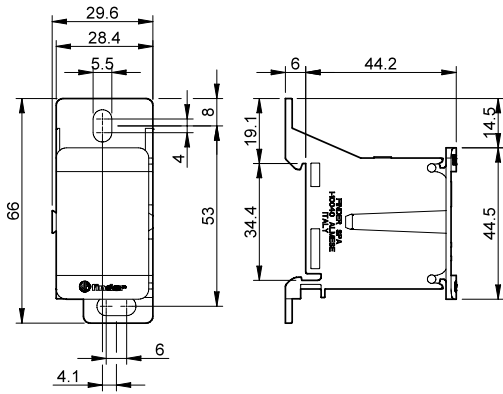

Type 9D.01.5.125.0206

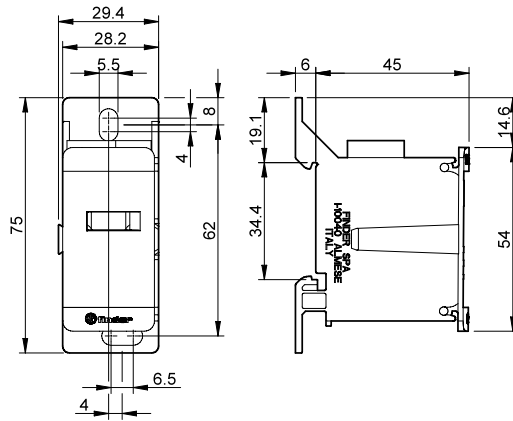

Type 9D.01.5.175.0210

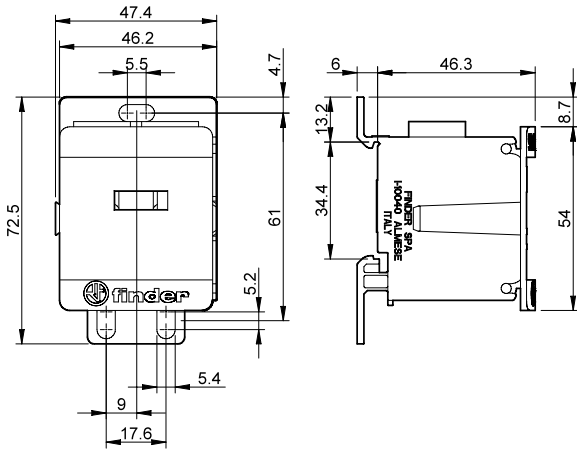

Type 9D.01.5.250.0111

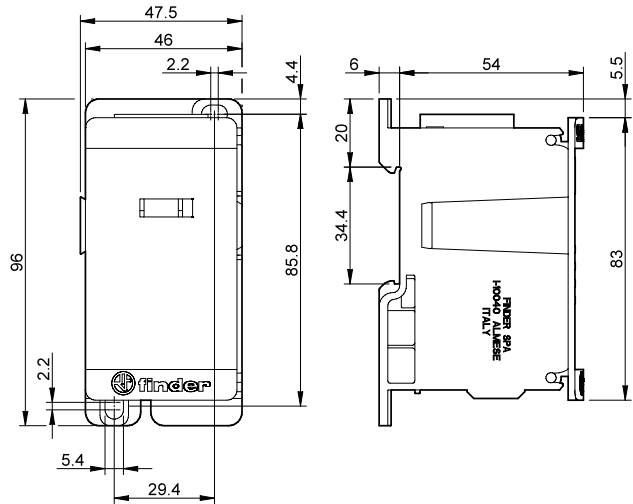

Type 9D.01.5.400.0111

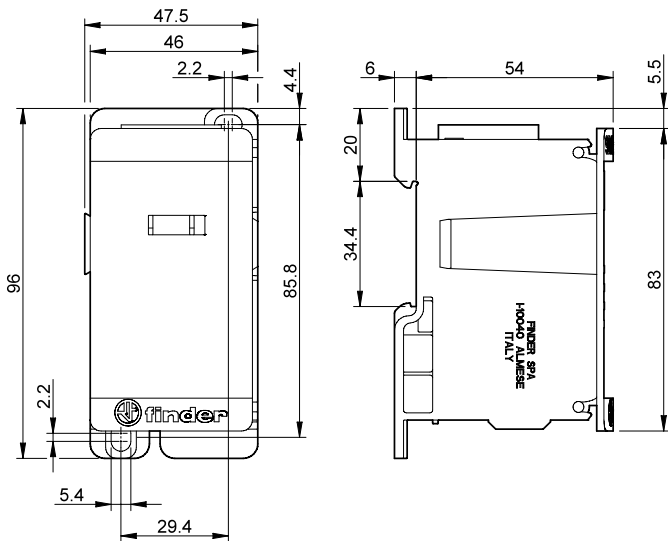

G

# Programmable Logic Relays

**8A**  
SERIES



Panels for electrical distribution



Packaging machines



Control and management of water



Control panels for pumps



Air Conditioner



Building automation



Forced-air ventilators





## Programmable Logic Relays (PLRs) with 8 input and 4 output relays

### Type 8A.04-8300

- Lite version with USB (type C port), ETH

### Type 8A.04-8310

- Plus version with USB (type C port), ETH and Modbus RS485

### Type 8A.04-8320

- Advanced version with USB (type C port), ETH, Modbus RS485, Wi-Fi and BLE
- 8 digital or analog (0...10V) input
- 4 relay output 10 A
- USB (type C port) port for programming, data logging and powering during configuration
- RJ45 port
- Connectivity (\*according to type):
  - USB
  - 1 Gbit Ethernet TCP/IP or Modbus TCP/IP
  - Modbus RS485\*
  - Wi-Fi + BLE\*
- LED status indicator for each output
- Programmable USER button
- Programming language via IDE as an option IEC-61131-3 (LD - SFC - FBD - ST - IL)
- 70 mm wide
- 35 mm rail (EN 60715) mount

8A.04

Screw terminal



For outline drawing see page 7

### Output specification

Contact configuration

Rated current/Maximum peak current A

Rated voltage/Maximum switching voltage V AC

Rated load AC1 VA

Rated load AC15 (230 V AC) VA

Breaking capacity DC1: 24/110/220 V A

Minimum switching load mW(V/mA)

Output operate/release time ms

Standard contact material

### Supply specification

Nominal voltage (U<sub>N</sub>) V DC

Rated power W

Operating range V DC

### Input circuit

Number of input

Type

Analog input type V

Analog input resolution

Input frequency kHz

Input voltage signal 0/signal 1

Maximum input voltage V DC

Input compatibility

Reverse polarity protection

### Technical data

Programm language

Minimum input signal ms

Electrical life at rated load in AC1 cycles

Ambient temperature range °C

Protection category

### Approvals (according to type)

## NEW 8A.04-8300



- Lite version
- USB Port
- RJ45 Port for ETH and Modbus TCP/IP

## NEW 8A.04-8310



- Plus version
- USB Port
- RJ45 Port for ETH and Modbus TCP/IP
- Modbus RS485 Port

## NEW 8A.04-8320



- Advanced version
- USB Port
- RJ45 Port for ETH and Modbus TCP/IP
- Modbus RS485 Port
- Wi-Fi/BLE internal module

# OPTA

Partnership with



## Ordering information

Example: 8A series, Lite PLR version, 4 NO (SPST) - 10 A, 8 digital/analog input, 12...24 V DC.

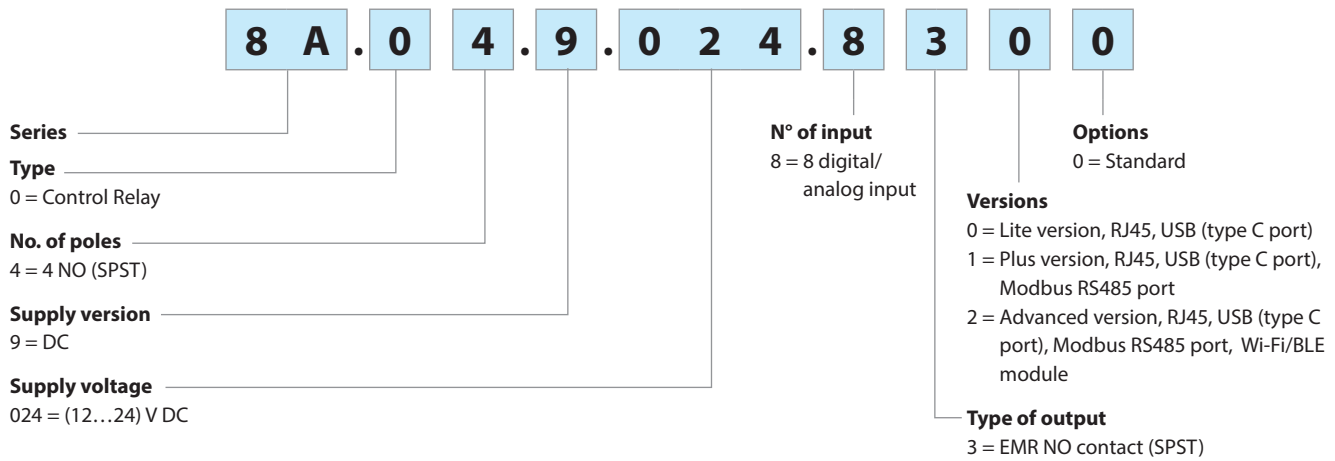



## Technical data

Insulation				
	between input and output circuit	V AC	4000	
	between open contacts	V AC	1000	
Insulation (1.2/50 μs) between input and output		kV	6	
EMC specifications				
Type of test		Reference standard		
Electrostatic discharge	contact discharge	EN 61000-4-2	4 kV	
	air discharge	EN 61000-4-2	8 kV	
Radio-frequency electromagnetic field (80 ÷ 1000 MHz)		EN 61000-4-3	10 V/m	
Fast transients (burst) (5-50 ns, 5 kHz) on Supply terminals		EN 61000-4-4	4 kV	
Surges (1.2/50 μs) on Supply terminals	common mode	EN 61000-4-5	4 kV	
	differential mode	EN 61000-4-5	4 kV	
	on input terminals	common mode	EN 61000-4-5	4 kV
	differential mode	EN 61000-4-5	4 kV	
Radio-frequency common mode (0.15 ÷ 80 MHz) on Supply terminals		EN 61000-4-6	10 V	
Radiated and conducted emission		EN 55022	class B	
Other data				
Power lost to the environment	without contact current	W	1.4	
	with rated current	W	3.2	
PLC to PLC communication and PLC to network communication (Ethernet)		<b>Ethernet:</b> – For Modbus TCP communication – As standard TCP/IP – RJ45 connector CAT5 cable, 2X LAN status led indicators <b>RS485:</b> – For Modbus RTU communication – For custom serial communication		
Wireless connectivity		Wi-Fi and Bluetooth® Low Energy		
Maximum program memory		1 MB internal		
External memory module		USB-C pendrive		
Data Logging		USB-C Stick + internal flash memory		
Flash memory		2MB int + 16MB Flash QSPI		
RESET button		YES		
USER button		Push button configurable for user purposes		
MCU		STMicroelectronics STM32H747XI Dual ARM® Cortex® M7/M4 IC: 1x ARM® Cortex® -M7 core up to 480 MHz 1x ARM® Cortex® -M4 core up to 240 MHz		
Secure element		ATECC608B		
Programming interface		USB-C + OTA via Web Editor (Cloud) + Ethernet		
RTC power reserve		10 days at 25 °C		
RTC accuracy		10 min/year @25 °C 37.5 min/year @ -10...+70 °C		
Cloud support		Arduino Cloud via Wi-Fi and Ethernet or the Cloud services		
Response time ON/OFF		ms	6/4	
Bounce time NO/NC		ms	3/6	
Terminals		Screw terminals		
Wire strip length		mm	9	
Screw torque		Nm	0.5	
Min. wire size		solid cable	stranded cable	
	mm²	0.5	0.5	
	AWG	20	20	
Max. wire size		solid cable	stranded cable	
	mm²	1 x 2.5 / 2 x 1.5	1 x 2.5 / 2 x 1	
	AWG	1 x 14 / 2 x 16	1 x 14 / 2 x 16	

Front view

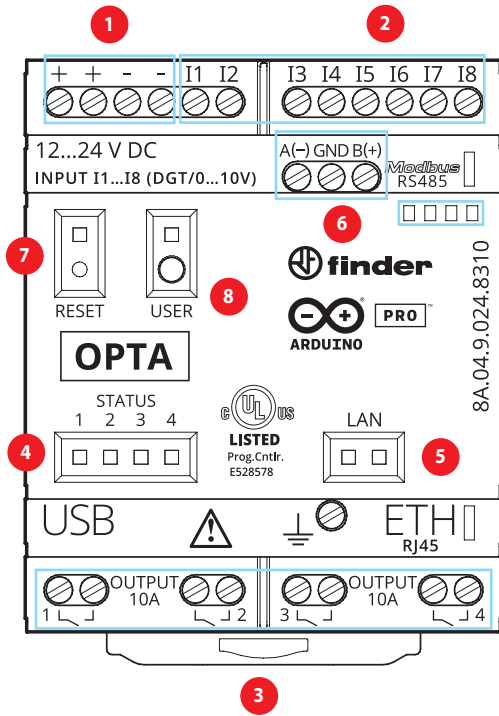

- 1 Supply terminals**  
12...24 V DC, Split terminals to facilitate wiring.
- 2 Input terminals**  
11...I8 digital/analog (0...10 V) input configurable via IDE.
- 3 Output terminals**  
1...4 Output relay, 10 A 250 V AC, NO contact.
- 4 LED Status**  
1...4 LED Status configurable via IDE.  
For example for 1...4 output relay LED ON = Contact CLOSE.
- 5 LED Ethernet port status**  
Status of ETH connection.
- 6 Modbus RS485 Port**  
Terminals for Modbus over RS485 protocol.
- 7 HARDWARE RESET**  
Button for hardware reset. BE CAREFUL. Press the 'RESET' button with the tip of a small non-metallic insulated tool.
- 8 Programmable USER button**  
Button configurable via IDE by user, according to application (ex. RUN/STOP, ON/OFF, BLE pair).

Contact specification

F 8A - Electrical life (AC) v contact current

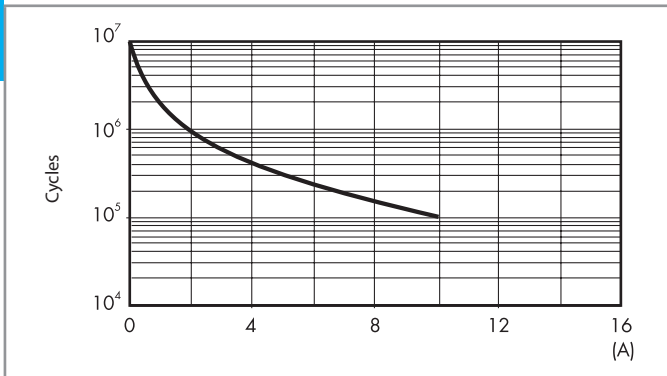

H 8A - Maximum DC1 breaking capacity

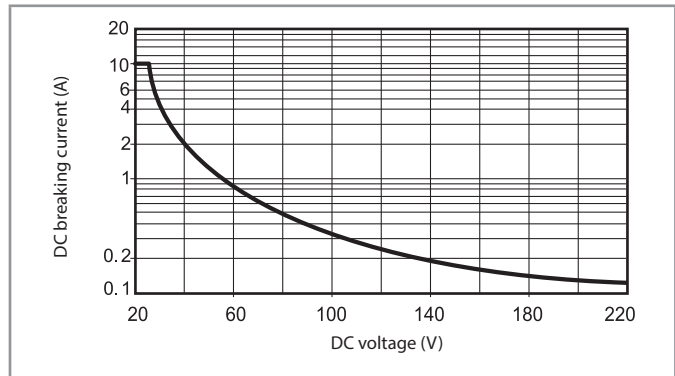

- When switching a resistive load (DC1) having voltage and current values under the curve, an electrical life of  $\geq 100 \cdot 10^3$  can be expected.
- In the case of DC13 loads, the connection of a diode in parallel with the load will permit a similar electrical life as for a DC1 load.  
Note: the release time for the load will be increased.

## Wiring diagrams

Type 8A.04-8300

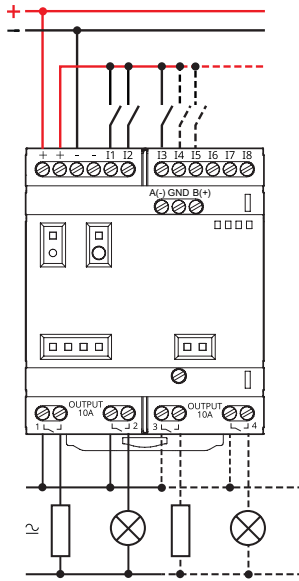

Type 8A.04-8310/8320

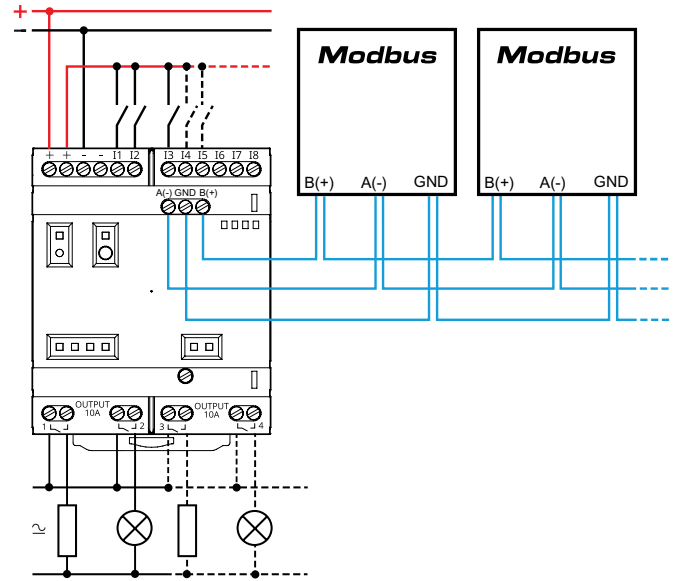

## Getting "Started Guide"

### Getting started - IDE

If you want to program your 8A.04 while offline you need to install the Arduino Desktop IDE. To connect the 8A.04 to your computer, you'll need a USB-C cable. This also provides power to the board, as indicated by the LED. <https://opta.findernet.com/en/tutorial/getting-started>

### Getting started - Arduino Web Editor

All Arduino boards, including this one, work out-of-the-box on the Arduino Web Editor, by just installing a simple plugin. The Arduino Web Editor is hosted online, therefore it will always be up-to-date with the latest features and support for all boards. Follow to start coding on the browser and upload your sketches onto your board. <https://opta.findernet.com/en/#software>

### Getting started - Arduino IoT Cloud

All Arduino IoT enabled products are supported on Arduino IoT Cloud which allows you to Log, graph and analyze sensor data, trigger events, and automate your home or business.

### Online resources

Now that you have gone through the basics of what you can do with the board you can explore the endless possibilities it provides by checking exciting projects on ProjectHub and the Arduino Library Reference <https://opta.findernet.com/en/>

### Board Recovery

All Arduino boards have a built-in bootloader which allows flashing the board via USB. In case a sketch locks up the processor and the board is not reachable anymore via USB it is possible to enter bootloader mode by double-tapping the reset button right after power up.

## Outline drawings

Type 8A.04-8300  
Screw terminal

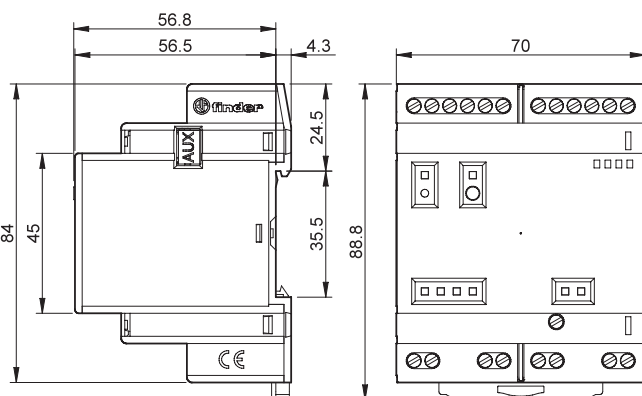

Type 8A.04-8310/8320  
Screw terminal

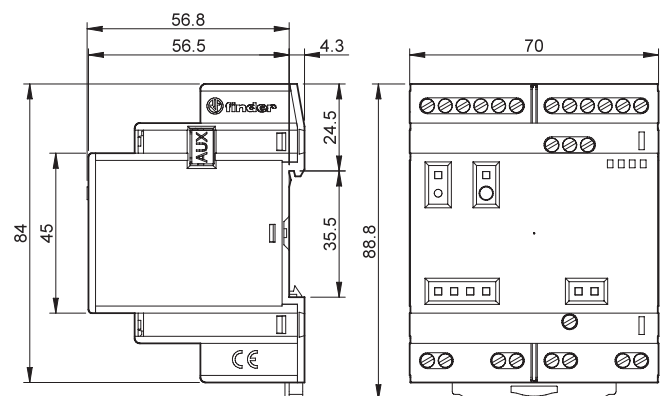



# Modular timers

## 1 - 6 - 8 - 16 A



Building automation



Elevators and lifts



Automation for blinds, grilles and shutters



Hoists and cranes



Panels for electrical distribution



Door and gate openers



80  
SERIES



**Multi-function and mono-function timer range**

**80.01 - Multi-function & multi-voltage**

**80.11 - On-delay, multi-voltage**

- 17.5 mm wide
- Six time scales from 0.1 s to 24 h
- High input/output isolation
- 35 mm rail (EN 60715) mount
- "Blade + cross" - both flat blade and cross head screw drivers can be used to adjust the range and function selectors, the timing trimmer, and to disengage the rail mounting clip
- New multi-voltage versions with "PWM clever" technology

**80.01**



- Multi-voltage
- Multi-function

**80.11**



- Multi-voltage
- Mono-function

80.01 / 80.11  
Screw terminal



- AI:** On-delay  
**DI:** Interval  
**SW:** Symmetrical flasher (starting pulse on)  
**BE:** Off-delay with control signal  
**CE:** On- and off-delay with control signal  
**DE:** Interval with control signal on

**AI:** On-delay

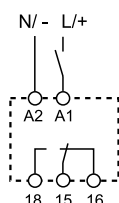

Wiring diagram  
(without control signal)

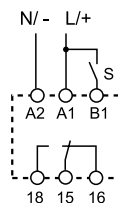

Wiring diagram  
(with control signal)

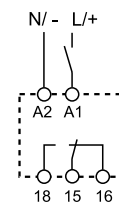

Wiring diagram  
(without control signal)

FOR UL RATINGS SEE:

"General technical information" page V

For outline drawing see page 9

**Contact specification**

Contact configuration		1 CO (SPDT)	1 CO (SPDT)
Rated current/Maximum peak current	A	16/30	16/30
Rated voltage/ Maximum switching voltage	V AC	250/400	250/400
Rated load AC1	VA	4000	4000
Rated load AC15 (230 V AC)	VA	750	750
Single phase motor rating (230 V AC)	kW	0.55	0.55
Breaking capacity DC1: 24/110/220 V	A	16/0.3/0.12	16/0.3/0.12
Minimum switching load	mW (V/mA)	500 (10/5)	500 (10/5)
Standard contact material		AgNi	AgNi

**Supply specification**

Nominal voltage (U <sub>N</sub> )	V AC (50/60 Hz)	12...240	24...240
	V DC	12...240	24...240
Rated power AC/DC	VA (50 Hz)/W	< 1.8/< 1	< 1.8/< 1
Operating range	V AC	10.8...265	16.8...265
	V DC	10.8...265	16.8...265

**Technical data**

Specified time range		(0.1...2)s, (1...20)s, (0.1...2)min, (1...20)min, (0.1...2)h, (1...24)h	
Repeatability	%	± 1	± 1
Recovery time	ms	100	100
Minimum control impulse	ms	50	—
Setting accuracy-full range	%	± 5	± 5
Electrical life at rated load in AC1	cycles	50 · 10 <sup>3</sup>	50 · 10 <sup>3</sup>
Ambient temperature range	°C	-20...+60	-20...+60
Protection category		IP 20	IP 20

**Approvals** (according to type)



**Mono-function timer range****80.21 - Interval, multi-voltage****80.41 - Off-delay with control signal, multi-voltage****80.91 - Asymmetrical flasher, multi-voltage**

- 17.5 mm wide
- Six time scales from 0.1 s to 24 h
- High input/output isolation
- 35 mm rail (EN 60715) mount
- "Blade + cross" - both flat blade and cross head screw drivers can be used to adjust the range and function selectors, the timing trimmer, and to disengage the rail mounting clip
- New multi-voltage versions with "PWM clever" technology

80.21 / 80.41 / 80.91

Screw terminal



FOR UL RATINGS SEE:

"General technical information" page V

For outline drawing see page 9

**Contact specification**

Contact configuration		1 CO (SPDT)	1 CO (SPDT)	1 CO (SPDT)
Rated current/Maximum peak current	A	16/30	16/30	16/30
Rated voltage/ Maximum switching voltage	V AC	250/400	250/400	250/400
Rated load AC1	VA	4000	4000	4000
Rated load AC15 (230 V AC)	VA	750	750	750
Single phase motor rating (230 V AC)	kW	0.55	0.55	0.55
Breaking capacity DC1: 24/110/220 V	A	16/0.3/0.12	16/0.3/0.12	16/0.3/0.12
Minimum switching load	mW (V/mA)	500 (10/5)	500 (10/5)	500 (10/5)
Standard contact material		AgNi	AgNi	AgNi

**Supply specification**

Nominal voltage ( $U_N$ )	V AC (50/60 Hz)	24...240	24...240	12...240
	V DC	24...240	24...240	12...240
Rated power AC/DC	VA (50 Hz)/W	< 1.8/< 1	< 1.8/< 1	< 1.8/< 1
Operating range	V AC	16.8...265	16.8...265	10.8...265
	V DC	16.8...265	16.8...265	10.8...265

**Technical data**

Specified time range		(0.1...2)s, (1...20)s, (0.1...2)min, (1...20)min, (0.1...2)h, (1...24)h		
Repeatability	%	± 1	± 1	± 1
Recovery time	ms	100	100	100
Minimum control impulse	ms	—	50	50
Setting accuracy-full range	%	± 5	± 5	± 5
Electrical life at rated load in AC1	cycles	50 · 10 <sup>3</sup>	50 · 10 <sup>3</sup>	50 · 10 <sup>3</sup>
Ambient temperature range	°C	-20...+60	-20...+60	-20...+60
Protection category		IP 20	IP 20	IP 20

**Approvals** (according to type)**80.21**

- Multi-voltage
- Mono-function

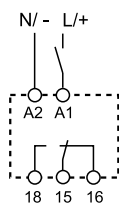
**DI:** IntervalWiring diagram  
(without control signal)**80.41**

- Multi-voltage
- Mono-function

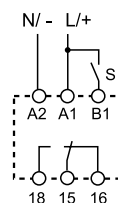
**BE:** Off-delay with control signalWiring diagram  
(with control signal)**80.91**

- Multi-voltage
- Mono-function

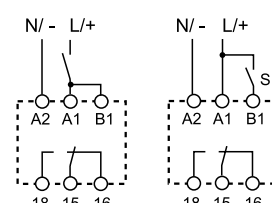
**LI:** Asymmetrical flasher  
(starting pulse on)**LE:** Asymmetrical flasher (starting pulse on) with control signalWiring diagram  
(without control signal)Wiring diagram  
(with control signal)



**Multi-function and multi-voltage solid-state output timer**

- 17.5 mm wide
- Six time scales from 0.1 s to 24 h
- High input/output isolation
- 35 mm rail (EN 60715) mount
- Multi-voltage output (24...240 V AC/DC), independent from the input voltage
- "Blade + cross" - both flat blade and cross head screw drivers can be used to adjust the range and function selectors, the timing trimmer, and to disengage the rail mounting clip
- Multi-voltage input with "PWM clever" technology

80.71  
Screw terminal



For outline drawing see page 9

**Output circuit**

Contact configuration	1 NO (SPST-NO)	
Rated current	A	1
Rated voltage	V AC/DC	24...240
Switching voltage range	V AC/DC	19...265
Rated load AC15	A	1
Rated load DC1	A	1
Minimum switching current	mA	0.5
Max. "OFF-state" leakage current	mA	0.05
Max. "ON-state" voltage drop	V	2.8

**Input circuit**

Nominal voltage (U <sub>N</sub> )	V AC (50/60 Hz)	24...240
	V DC	24...240
Rated power	VA (50 Hz)/W	1.3/1.3
Operating range	V AC	19...265
	V DC	19...265

**Technical data**

Specified time range	(0.1...2)s, (1...20)s, (0.1...2)min, (1...20)min, (0.1...2)h, (1...24)h	
Repeatability	%	± 1
Recovery time	ms	100
Minimum control impulse	ms	50
Setting accuracy-full range	%	± 5
Electrical life	cycles	100 · 10 <sup>6</sup>
Ambient temperature range	°C	-20...+50
Protection category	IP 20	

**Approvals** (according to type)



80.71



- Multi-voltage
- Multi-function

**AI:** On-delay  
**DI:** Interval  
**SW:** Symmetrical flasher (starting pulse on)  
**BE:** Off-delay with control signal  
**CE:** On- and off-delay with control signal  
**DE:** Interval with control signal on

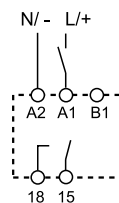

Wiring diagram  
(without control signal)

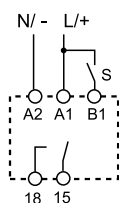

Wiring diagram  
(with control signal)

**Mono-function timer range****80.61 - Power off-delay (True off-delay), multi-voltage****80.82 - Star-delta, multi-voltage**

- 17.5 mm wide
- Rotary range selector, and timing trimmer
- Four time scales from 0.05s to 180 s (type 80.61)
- Six time scales from 0.1 s to 20min (type 80.82)
- High input/output isolation
- 35 mm rail (EN 60715) mount

80.61 / 80.82  
Screw terminal**80.61**

- Multi-voltage
- Mono-function

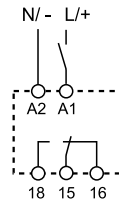
**BI:** Power off-delay (True off-delay)Wiring diagram  
(without control signal)**80.82**

- Multi-voltage
- Mono-function
- Transfer time can be regulated (0.05...1)s

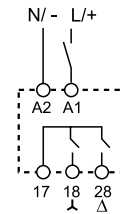
**SD:** Star-deltaWiring diagram  
(without control signal)

FOR UL RATINGS SEE:

"General technical information" page V

For outline drawing see page 9

**Contact specification**

Contact configuration		1 CO (SPDT)	2 NO (DPST-NO)
Rated current/Maximum peak current	A	8/15	6/10
Rated voltage/ Maximum switching voltage	V AC	250/400	250/400
Rated load AC1	VA	2000	1500
Rated load AC15 (230 V AC)	VA	400	300
Single phase motor rating (230 V AC)	kW	0.3	—
Breaking capacity DC1: 24/110/220 V	A	8/0.3/0.12	6/0.2/0.12
Minimum switching load	mW (V/mA)	300 (5/5)	500 (12/10)
Standard contact material		AgNi	AgNi

**Supply specification**

Nominal voltage (U <sub>N</sub> )	V AC (50/60 Hz)	24...240	24...240
	V DC	24...220	24...240
Rated power AC/DC	VA (50 Hz)/W	< 0.6/< 0.6	< 1.3/< 0.8
Operating range	V AC	16.8...265	16.8...265
	V DC	16.8...242	16.8...265

**Technical data**

Specified time range		(0.05...2)s, (1...16)s, (8...70)s, (50...180)s	(0.1...2)s, (1...20)s, (0.1...2)min, (1...20)min
Repeatability	%	± 1	± 1
Recovery time	ms	—	100
Minimum control impulse	ms	500 (A1-A2)	—
Setting accuracy-full range	%	± 5	± 5
Electrical life at rated load in AC1	cycles	100 · 10 <sup>3</sup>	60 · 10 <sup>3</sup>
Ambient temperature range	°C	-20...+60	-20...+60
Protection category		IP 20	IP 20

**Approvals** (according to type)

**Multi-function and multi-voltage**

- 17.5 mm wide
- Six time scales from 0.1 s to 24 h
- High input/output isolation
- 35 mm rail (EN 60715) mount
- "Blade + cross" - both flat blade and cross head screw drivers can be used to adjust the range and function selectors, the timing trimmer, and to disengage the rail mounting clip
- New multi-voltage versions with "PWM clever" technology

80.51.0.240.0000  
Screw terminal

80.51.0.240.P000  
Push-in terminal



FOR UL RATINGS SEE:

"General technical information" page V

For outline drawing see page 9

**Contact specification**

Contact configuration	
Rated current/Maximum peak current	A
Rated voltage/ Maximum switching voltage	V AC
Rated load AC1	VA
Rated load AC15 (230 V AC)	VA
Single phase motor rating (230 V AC)	kW
Breaking capacity DC1: 24/110/220 V	A
Minimum switching load	mW (V/mA)
Standard contact material	

**Supply specification**

Nominal voltage (U <sub>N</sub> )	V AC (50/60 Hz)
	V DC
Rated power AC/DC	VA (50 Hz)/W
Operating range	V AC
	V DC

**Technical data**

Specified time range	
Repeatability	%
Recovery time	ms
Minimum control impulse	ms
Setting accuracy-full range	%
Electrical life at rated load in AC1	cycles
Ambient temperature range	°C
Protection category	

**Approvals** (according to type)



- Multi-voltage (24...240) V AC/DC
- Multi-function

- AI:** On-delay
- DI:** Interval
- SW:** Symmetrical flasher (starting pulse on)
- BE:** Off-delay with control signal
- CE:** On- and off-delay with control signal
- DE:** Interval with control signal on

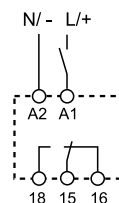

Wiring diagram  
(without control signal)

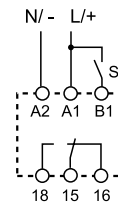

Wiring diagram  
(with control signal)

**Approvals** (according to type)



## Ordering information

Example: 80 series, modular timers, 1 CO (SPDT) - 16 A, supply rated at (12...240)V AC/DC.

**8 0 . 0 1 . 0 . 2 4 0 . 0 0 0 0**

### Series

#### Type

- 0 = Multi-function (AI, DI, SW, BE, CE, DE)
- 1 = On-delay (AI)
- 2 = Interval (DI)
- 4 = Off-delay with control signal (BE)
- 5 = Multi-function (AI, DI, SW, BE, CE, DE)
- 6 = Power off-delay (True off-delay) (BI)
- 7 = Multi-function with solid state output (AI, DI, SW, BE, CE, DE)
- 8 = Star-delta (SD)
- 9 = Asymmetrical flasher (LI, LE)

### Versions

- 0 = Standard
- P = Push-in (only for 80.51)

### Supply voltage

- 240 = (12...240)V AC/DC (80.01, 80.91)
- 240 = (24...240)V AC/DC (80.11, 80.21, 80.41, 80.51, 80.71, 80.82)
- 240 = (24...240)V AC, (24...220)V DC (80.61)

### Supply version

- 0 = AC (50/60 Hz)/DC

### No. of poles

- 1 = 1 CO (SPDT)
- 1 = 1 NO (SPST-NO), type 80.71 only
- 2 = 2 NO (DPST-NO), type 80.82 only

## Technical data

### Insulation

			80.01/11/21/41/51/82/91	80.61	80.71
Dielectric strength	between input and output circuit	V AC	4000	2500	2500
	between open contacts	V AC	1000	1000	—
Insulation (1.2/50 μs) between input and output		kV	6	4	4

### EMC specifications

Type of test		Reference standard	80.01/11/21/41/61/71/91	80.51/82
Electrostatic discharge	contact discharge	EN 61000-4-2	4 kV	4 kV
	air discharge	EN 61000-4-2	8 kV	8 kV
Radio-frequency electromagnetic field (80 ÷ 1000 MHz)		EN 61000-4-3	10 V/m	10 V/m
Fast transients (burst) (5-50 ns, 5 kHz) on Supply terminals		EN 61000-4-4	4 kV	4 kV
Surges (1.2/50 μs) on Supply terminals	common mode	EN 61000-4-5	4 kV	4 kV
	differential mode	EN 61000-4-5	4 kV	4 kV
	common mode	EN 61000-4-5	4 kV	4 kV
	differential mode	EN 61000-4-5	4 kV	4 kV
Radio-frequency common mode (0.15 ÷ 80 MHz) on Supply terminals		EN 61000-4-6	10 V	10 V
Radiated and conducted emission		EN 55022	class B	class A

### Other data

Current absorption on signal control (B1)			< 1 mA
Power lost to the environment	without contact current	W	1.4
	with rated current	W	3.2

### Terminals

			Screw terminals	Push-in terminals
Wire strip length		mm	10	10
Screw torque		Nm	0.8	—
Min. wire size			solid cable	solid cable
		mm <sup>2</sup>	0.5	0.75
		AWG	20	18
Max. wire size			solid cable	solid cable
		mm <sup>2</sup>	1 x 6 / 2 x 4	1 x 1.5 / 2 x 1.5
		AWG	1 x 10 / 2 x 12	1 x 16 / 2 x 16
Min. wire size			stranded cable	stranded cable
		mm <sup>2</sup>	0.5	0.75
		AWG	20	18
Max. wire size			stranded cable	stranded cable
		mm <sup>2</sup>	1 x 4 / 2 x 2.5	1 x 2.5 / 2 x 2.5
		AWG	1 x 12 / 2 x 14	1 x 14 / 2 x 14

Outline drawings

Types 80.01/80.51  
Screw terminal

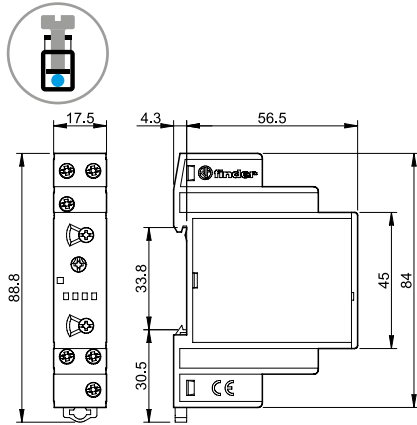

Type 80.51  
Push-in terminal

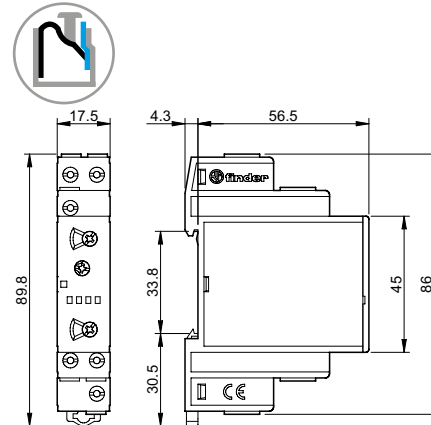

Types 80.11/80.21/80.61  
Screw terminal

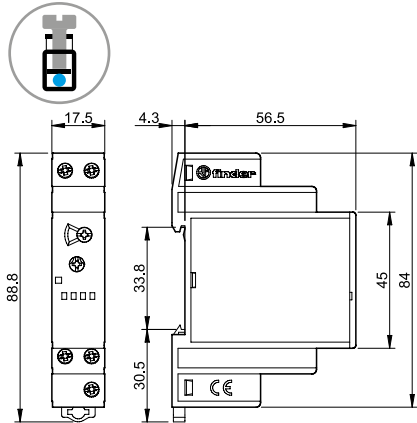

Type 80.41  
Screw terminal

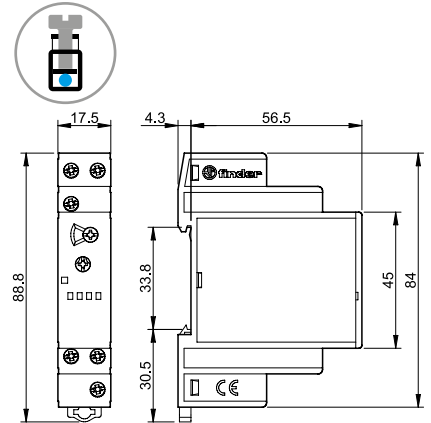

Type 80.91  
Screw terminal

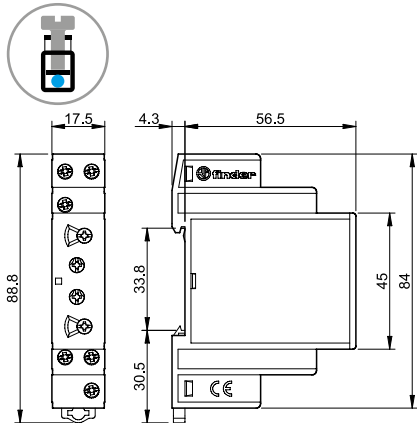

Type 80.71  
Screw terminal

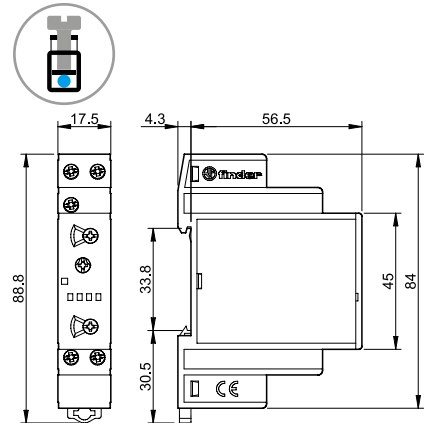

Type 80.82  
Screw terminal

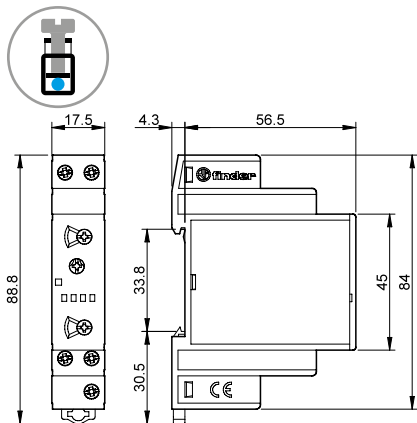

Functions

U = Supply voltage

S = Signal switch

= Output contact

LED*	Supply voltage	NO output contact	Contacts	
			Open	Closed
	OFF	Open	15 - 18	15 - 16
	ON	Open	15 - 18	15 - 16
	ON	Open (Timing in Progress)	15 - 18	15 - 16
	ON	Closed	15 - 16	15 - 18

\* The LED on type 80.61 is illuminated only when the supply voltage is applied to the timer; during the timing period the LED is not illuminated.

Without control signal = Start via contact in supply line (A1).

With control signal = Start via contact into control terminal (B1).

Wiring diagram

Without control signal

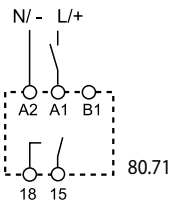
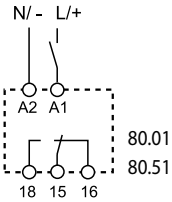

Type  
80.01  
80.51  
80.71

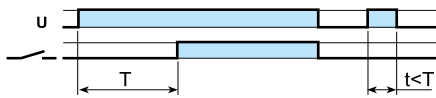

**(A1) On-delay.**

Apply power to timer. Output contacts transfer after preset time has elapsed. Reset occurs when power is removed.

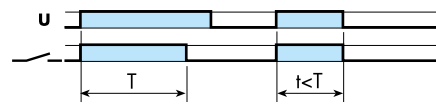

**(DI) Interval.**

Apply power to timer. Output contacts transfer immediately. After the preset time has elapsed, contacts reset.

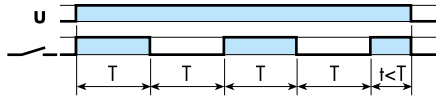

**(SW) Symmetrical flasher (starting pulse on).**

Apply power to timer. Output contacts transfer immediately and cycle between ON and OFF for as long as power is applied. The ratio is 1:1 (time on = time off).

With control signal

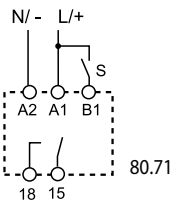
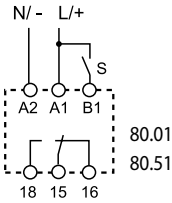

80.01  
80.51  
80.71

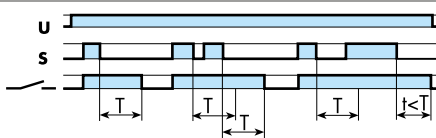

**(BE) Off-delay with control signal.**

Power is permanently applied to the timer. The output contacts transfer immediately on closure of the Signal Switch (S). Opening the Signal Switch initiates the preset delay, after which time the output contacts reset.

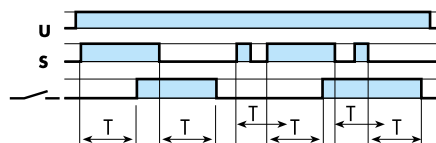

**(CE) On- and off-delay with control signal.**

Power is permanently applied to the timer. Closing the Signal Switch (S) initiates the preset delay, after which time the output contacts transfer. Opening the Signal switch initiates the same preset delay, after which time the output contacts reset.

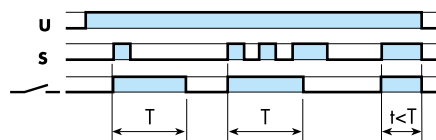

**(DE) Interval with control signal on.**

Power is permanently applied to the timer. On momentary or maintained closure of Signal Switch (S), the output contacts transfer, and remain so for the duration of the preset delay, after which they reset.

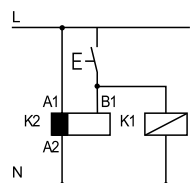

NOTE: The function must be set before energising the timer.

• Possible to control an external load, such as another relay coil or timer, connected to the control signal terminal B1.

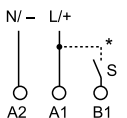

\* With DC supply, positive polarity has to be connected to B1 terminal (according to EN 60204-1).

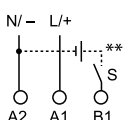

\*\* A voltage other than the supply voltage can be applied to the command Start (B1), example:

A1 - A2 = 230 V AC  
B1 - A2 = 12 V DC

## Functions

### Wiring diagram

<p>Without control signal</p> <p>80.11/21/61</p> <p>80.82</p>	<p><b>Type</b></p> <p><b>80.11</b></p> <p><b>80.21</b></p> <p><b>80.61</b></p> <p><b>80.82</b></p>		<p><b>(AI) On-delay.</b> Apply power to timer. Output contacts transfer after preset time has elapsed. Reset occurs when power is removed.</p> <p><b>(DI) Interval.</b> Apply power to timer. Output contacts transfer immediately. After the preset time has elapsed, contacts reset.</p> <p><b>(BI) Power off-delay (True off-delay).</b> Apply power to timer (minimum 500 ms). Output contacts transfer immediately. Removal of power initiates the preset delay, after which time the output contacts reset.</p> <p><b>(SD) Star-delta.</b> Apply power to timer. The star contact (Λ) closes immediately. After preset delay has elapsed the star contact (Λ) resets. After a further transfer time variable from (0.05...1)s the delta contact (Δ) closes and remains in that position, until reset on power off.</p>
<p>With control signal</p> <p>80.41</p>	<p><b>80.41</b></p>		<p><b>(BE) Off-delay with control signal.</b> Power is permanently applied to the timer. The output contacts transfer immediately on closure of the Signal Switch (S). Opening the Signal Switch initiates the preset delay, after which time the output contacts reset.</p>
<p>Without control signal</p> <p>80.91</p> <p>With control signal</p> <p>80.91</p>	<p><b>80.91</b></p>		<p><b>(LI) Asymmetrical flasher (starting pulse on).</b> Apply power to timer. Output contacts transfer immediately and cycle between ON and OFF for as long as power is applied. The ON (T<sub>1</sub>) and OFF (T<sub>2</sub>) times are independently adjustable.</p> <p><b>(LE) Asymmetrical flasher (starting pulse on) with control signal</b> Power is permanently applied to the timer. Closing Signal Switch (S) causes the output contacts to transfer immediately and cycle between ON (T<sub>1</sub>) and OFF (T<sub>2</sub>), until opened.</p>

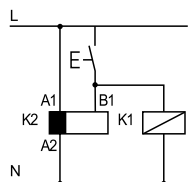

• Possible to control an external load, such as another relay coil or timer, connected to the control signal terminal B1.

\* With DC supply, positive polarity has to be connected to B1 terminal (according to EN 60204-1).

\*\* A voltage other than the supply voltage can be applied to the command Start (B1), example:

A1 - A2 = 230 V AC

B1 - A2 = 12 V DC

## Times scales

Rotary switch position series 80

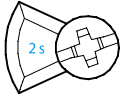

(0.1...2)s

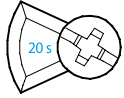

(1...20)s

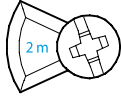

(0.1...2)min

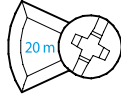

(1...20)min

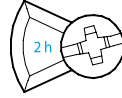

(0.1...2)h

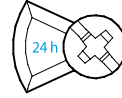

(1...24)h

## Accessories

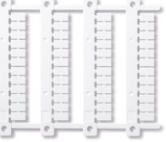

060.48

**Sheet of marker tags (CEMBRE Thermal transfer printers)** for relays types  
80.01/11/21/41/51/61/71 (48 tags), 6 x 12 mm

060.48



# Modular timers 16 A



Control panels



Milk processing plant



Punches, cleaners, planers and sanders



Hoists and cranes



Shipyards



Door and gate openers



81  
SERIES



**Multi-function and multi-voltage timer**

- One module 17.5 mm wide housing
- Seven functions (4 with supply start and 3 with control signal)
- Additional Reset function
- Six time ranges from 0.1 s to 10 h
- 35 mm rail (EN 60715) mounting

81.01

Screw terminal



**81.01**



- Multi-voltage (DC non polarized)
- Multi-function
- 35 mm rail (EN 60715) mounting

- AI:** On-delay  
**DI:** Interval  
**SW:** Symmetrical flasher (starting pulse on)  
**SP:** Symmetrical flasher (starting pulse off)  
**BE:** Off-delay with control signal  
**DE:** Interval with control signal on  
**EEb:** Interval with control signal off

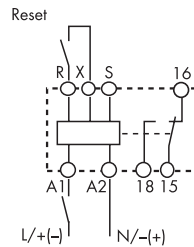

Wiring diagram  
(supply START)

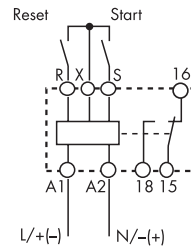

Wiring diagram  
(control signal)

For outline drawing see page 4

**Contact specification**

Contact configuration		1 CO (SPDT)
Rated current/Maximum peak current	A	16/30
Rated voltage/ Maximum switching voltage	V AC	250/400
Rated load AC1	VA	4000
Rated load AC15 (230 V AC)	VA	750
Single phase motor rating (230 V AC)	kW	0.55
Breaking capacity DC1: 24/110/220 V	A	16/0.3/0.12
Minimum switching load	mW (V/mA)	500 (10/5)
Standard contact material		AgNi

**Supply specification**

Nominal voltage ( $U_N$ )	V AC (50/60 Hz)	12...230
	V DC	12...230 (non polarized)
Rated power AC/DC	VA (50 Hz)/W	< 2/< 2
Operating range	V AC	10.8...250
	V DC	10.8...250

**Technical data**

Specified time range		(0.1...1)s, (1...10)s, (10...60)s, (1...10)min, (10...60)min, (1...10)h
Repeatability	%	± 1
Recovery time	ms	≤ 50
Minimum control impulse	ms	50
Setting accuracy-full range	%	± 5
Electrical life at rated load in AC1	cycles	100 · 10 <sup>3</sup>
Ambient temperature range	°C	-10...+50
Protection category		IP 20

**Approvals** (according to type)



### Ordering information

Example: 81 series, modular timer multi-voltage, 1 CO (SPDT) - 16 A, supply rated at (12...230)V AC/DC.

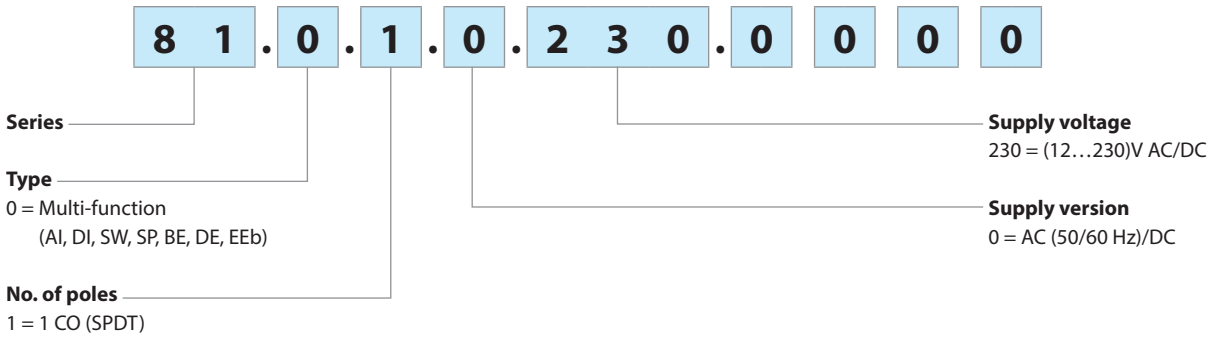

### Technical data

EMC specifications			
Type of test		Reference standard	
Electrostatic discharge	contact discharge	EN 61000-4-2	4 kV
	air discharge	EN 61000-4-2	8 kV
Radio-frequency electromagnetic field (80 ÷ 1000 MHz)		EN 61000-4-3	10 V/m
Fast transients (burst) (5-50 ns, 5 kHz) on Supply terminals		EN 61000-4-4	4 kV
Surges (1.2/50 µs) on Supply terminals	common mode	EN 61000-4-5	4 kV
	differential mode	EN 61000-4-5	4 kV
Radio-frequency common mode (0.15 ÷ 80 MHz) on Supply terminals		EN 61000-4-6	10 V
Radiated and conducted emission		EN 55022	class A
Other data			
Current absorption on signal control (B1)		< 1 mA (S-X)	< 1 mA (R-X)
Voltage potential on the input terminal R - X and S -X		Not galvanic separation from the supply voltage on A1 - A2	
Power lost to the environment	without contact current W	1.3	
	with rated current W	3.2	
Screw torque	Nm	0.8	
Max. wire size		solid cable	stranded cable
	mm <sup>2</sup>	1 x 6 / 2 x 4	1 x 4 / 2 x 2.5
	AWG	1 x 10 / 2 x 12	1 x 12 / 2 x 14

### Outline drawings

Type 81.01  
Screw Terminal

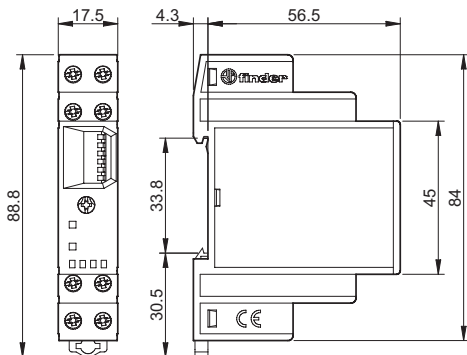

### Time range setting

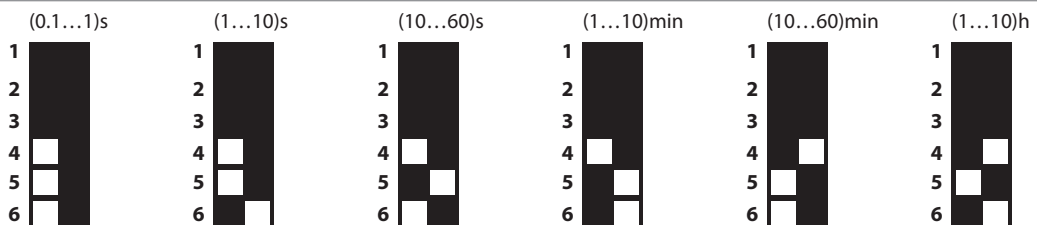

NOTE: time range and function must be set before energising the timer.

### Functions

- U** = Supply voltage
- S** = Signal switch
- R** = Reset
- = Output contact

LED (green)	LED (red)	Supply voltage	NO output contact	Contacts	
				Open	Closed
		OFF	Open	15 - 18	15 - 16
		ON	Open	15 - 18	15 - 16
		ON	Closed	15 - 16	15 - 18

Supply Start = Start via contact in supply line (A1).  
Control signal = Start via contact into control terminal (X-S).

### Wiring diagram

#### Supply START

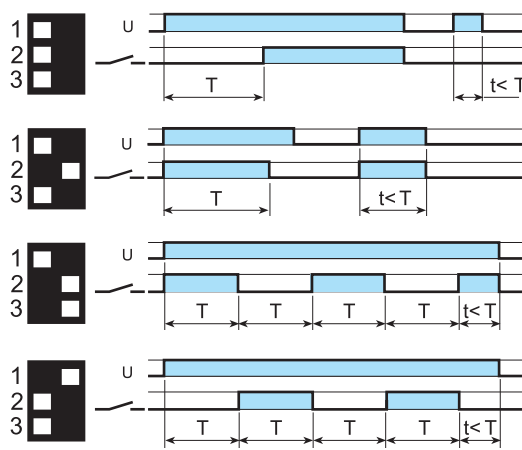
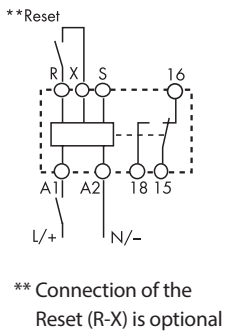

- (AI) On-delay.**  
Apply power to timer. Output contacts transfer after preset time has elapsed. Reset occurs when power is removed.
- (DI) Interval.**  
Apply power to timer. Output contacts transfer immediately. After the preset time has elapsed, contacts reset.
- (SW) Symmetrical flasher (starting pulse on).**  
Apply power to timer. Output contacts transfer immediately and cycle between ON and OFF for as long as power is applied. The ratio is 1:1 (time on = time off).
- (SP) Symmetrical flasher (starting pulse off).**  
Apply power to timer. First transfer of contact occurs after preset time has elapsed. The timer now cycles between OFF and ON as long as power is applied. The ratio is 1:1 (time on = time off).

#### Control signal

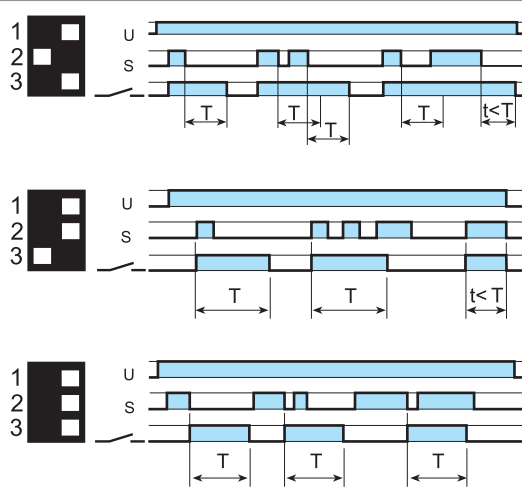
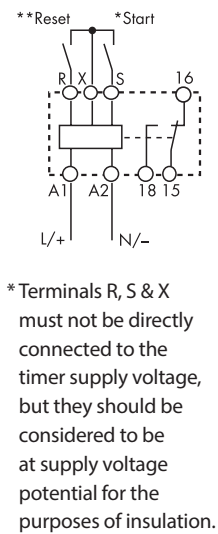

- (BE) Off-delay with control signal.**  
Power is permanently applied to the timer. The output contacts transfer immediately on closure of the Signal Switch (S). Opening the Signal Switch initiates the preset delay, after which time the output contacts reset.
- (DE) Interval with control signal on.**  
Power is permanently applied to the timer. On momentary or maintained closure of Signal Switch (S), the output contacts transfer, and remain so for the duration of the preset delay, after which they reset.
- (EEb) Interval with control signal off.**  
Power is permanently applied to the timer. On opening of the Signal Switch (S) the output contacts transfer, and remain so for the duration of the preset delay, after which they reset.

### RESET function (R)

For each and every function and time range, the timer is immediately reset when the reset switch is closed.

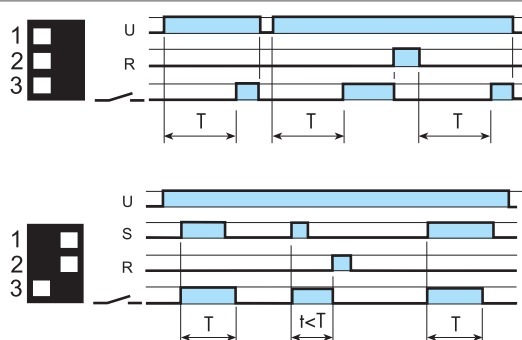

- Example:  
Supply START; ON delay function  
**Closing the external reset switch immediately resets the timer. Opening the reset switch re-initiates the timing function.**
- Example:  
Control signal; ON pulse function.  
**Closing the external reset switch terminates the interval time and resets the timer. To re-start, it is necessary to open the reset switch, before closing the control signal contact.**

## Accessories



019.01

**Identification tag**, for type 81.01, plastic, 1 tag, 17 x 25.5 mm

019.01

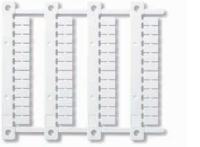

060.48

**Sheet of marker tags (CEMBRE Thermal transfer printers)** for type 81.01, plastic,  
48 tags, 6 x 12 mm

060.48

# Modular timers 8 - 10 - 12 - 16 A



Panels for electrical  
distribution



Automatic  
car-washes



Packaging  
machines



Pump control



Industrial  
refrigeration



Fountains

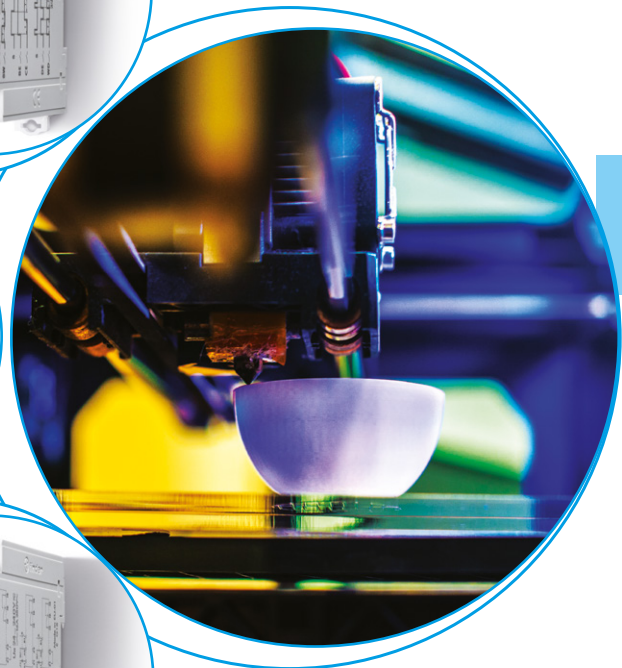

83  
SERIES





**Multi-function and Mono-function timer range**

**Type 83.01**

- Multi-function & multi-voltage
- 1 Pole

**Type 83.11**

- ON-delay, multi-voltage

**Type 83.21**

- Interval, multi-voltage
- 22.5 mm wide
- Eight time scales from 0.05 s to 10 days
- High input/output isolation
- Wide supply range (24...240)V AC/DC
- 35 mm rail (EN 60715) mount
- "Blade + cross" - both flat blade and cross head screw drivers can be used to adjust the range and function selectors, the timing trimmer, and to disengage the rail mounting clip
- Multi-voltage versions with "PWM clever" technology
- Complies with EN 45545-2:2013 (protection against fire of materials), EN 61373 (resistance against random vibrations and shock, Category 1, Class B), EN 50155 (resistance to temperature and humidity, T1 class)

**83.01**



- Multi-voltage
- Multi-function

- AI:** On-delay  
**DI:** Interval  
**GI:** Pulse delayed  
**SW:** Symmetrical flasher (starting pulse on)  
**BE:** Off-delay with control signal  
**CE:** On- and off-delay with control signal  
**DE:** Interval with control signal on  
**WD:** Watchdog (Retriggerable interval with control signal on)

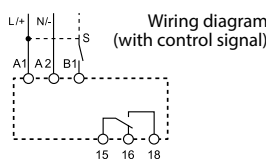
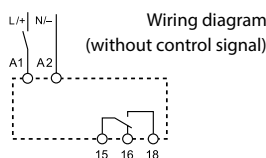

**83.11**



- Multi-voltage
- Mono-function

- AI:** On-delay

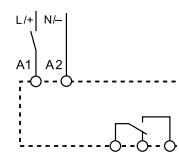

Wiring diagram (without control signal)

**83.21**



- Multi-voltage
- Mono-function

- DI:** Interval

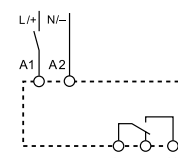

Wiring diagram (without control signal)

<sup>(1)</sup> Short term (10 min) + 70°C  
For outline drawing see page 9

**Contact specification**

Contact configuration		1 CO (SPDT)	1 CO (SPDT)	1 CO (SPDT)
Rated current/Maximum peak current	A	16/30	16/30	16/30
Rated voltage/ Maximum switching voltage	V AC	250/400	250/400	250/400
Rated load AC1	VA	4000	4000	4000
Rated load AC15 (230 V AC)	VA	750	750	750
Single phase motor rating (230 V AC)	kW	0.5	0.5	0.5
Breaking capacity DC1: 24/110/220 V	A	16/0.3/0.12	16/0.3/0.12	16/0.3/0.12
Minimum switching load	mW (V/mA)	300 (5/5)	300 (5/5)	300 (5/5)
Standard contact material		AgNi	AgNi	AgNi

**Supply specification**

Nominal voltage (U <sub>N</sub> )	V AC (50/60 Hz)	24...240	24...240	24...240
	V DC	24...240	24...240	24...240
Rated power AC/DC	VA (50 Hz)/W	< 1.5/< 2	< 1.5/< 2	< 1.5/< 2
Operating range	V AC	16.8...265	16.8...265	16.8...265
	V DC	16.8...265	16.8...265	16.8...265

**Technical data**

Specified time range		(0.05...1)s, (0.5...10)s, (0.05...1)min, (0.5...10)min, (0.05...1)h, (0.5...10)h, (0.05...1)d, (0.5...10)d		
Repeatability	%	± 1	± 1	± 1
Recovery time	ms	200	200	200
Minimum control impulse	ms	50	—	—
Setting accuracy-full range	%	± 5	± 5	± 5
Electrical life at rated load in AC1	cycles	50 · 10 <sup>3</sup>	50 · 10 <sup>3</sup>	50 · 10 <sup>3</sup>
Ambient temperature range	°C	-20...+60 <sup>(1)</sup>	-20...+60 <sup>(1)</sup>	-20...+60 <sup>(1)</sup>
Protection category		IP 20	IP 20	IP 20

**Approvals** (according to type)



**Mono-function and multi-function timer range**

**Type 83.41**

- Off-delay with control signal, multi-voltage

**Type 83.52**

- Multi-function & multi-voltage
- 2 Pole (timed + instantaneous options), external time setting potentiometer option, pause function option

**Type 83.62**

- Power off-delay, multi-voltage, 2 Pole

- 1 Pole
- 22.5 mm wide
- Time scales:  
Type 83.62 - 0.05 s to 3 minutes
- Eight time scales from 0.05 s to 10 days
- High input/output isolation
- Wide supply range (24...240)V AC/DC
- 35 mm rail (EN 60715) mount
- "Blade + cross" - both flat blade and cross head screw drivers can be used to adjust the range and function selectors, the timing trimmer, and to disengage the rail mounting clip
- Multi-voltage versions with "PWM clever" technology
- Complies with EN 45545-2:2013 (protection against fire of materials), EN 61373 (resistance against random vibrations and shock, Category 1, Class B), EN 50155 (resistance to temperature and humidity, T1 class)

<sup>(1)</sup> Short term (10 min) + 70°C  
For outline drawing see page 9

**83.41**



- Multi-voltage
- Mono-function

**BE:** Off-delay with control signal

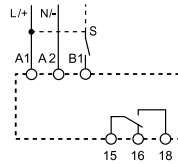

Wiring diagram  
(with control signal)

**83.52**



- Multi-voltage
- Multi-function
- Timing can be regulated using ext. Potentiometer
- 2 timed contacts or 1 timed + 1 instantaneous contact
- 3 functions with pause option

**AE:** On-delay with control signal  
**GE:** Pulse delayed with control signal on  
**IT:** Timing step  
**FE:** Interval with control signal on and off  
**EEa:** Interval with control signal off (retriggerable)  
**DEp:** Interval with control signal on and pause signal  
**BEp:** Off-delay with control signal and pause signal  
**SHp:** "Shower" function

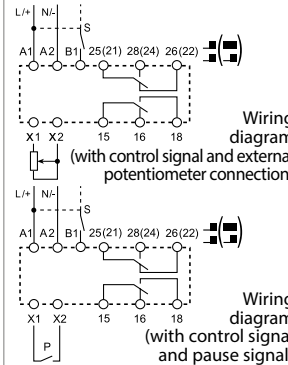

Wiring diagram  
(with control signal and external potentiometer connection)

Wiring diagram  
(with control signal and pause signal)

**83.62**



- Multi-voltage
- Mono-function
- 2 pole

**BI:** Power off-delay (True off-delay)

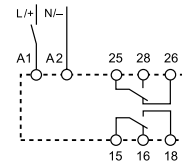

Wiring diagram  
(without control signal)

**Contact specification**

Contact configuration		1 CO (SPDT)	2 CO (DPDT)	2 CO (DPDT)
Rated current/Maximum peak current	A	16/30	12/30	8/15
Rated voltage/Maximum switching voltage	V AC	250/400	250/400	250/400
Rated load AC1	VA	4000	3000	2000
Rated load AC15 (230 V AC)	VA	750	750	400
Single phase motor rating (230 V AC)	kW	0.5	0.5	0.3
Breaking capacity DC1: 24/110/220 V	A	16/0.3/0.12	12/0.3/0.12	8/0.3/0.12
Minimum switching load	mW (V/mA)	300 (5/5)	300 (5/5)	300 (5/5)
Standard contact material		AgNi	AgNi	AgNi

**Supply specification**

Nominal voltage (U <sub>N</sub> )	V AC (50/60 Hz)	24...240	24...240	24...240
	V DC	24...240	24...240	24...220
Rated power AC/DC	VA (50 Hz)/W	< 1.5/< 2	< 2/< 2	< 1.5/< 2
Operating range	V AC	16.8...265	16.8...265	16.8...265
	V DC	16.8...265	16.8...265	16.8...242

**Technical data**

Specified time range		(0.05...1)s, (0.5...10)s, (0.05...1)min, (0.5...10)min, (0.05...1)h, (0.5...10)h, (0.05...1)d, (0.5...10)d		(0.05...2)s, (1...16)s, (8...70)s, (50...180)s
Repeatability	%	± 1	± 1	± 1
Recovery time	ms	200	200	—
Minimum control impulse	ms	50	50	500 ms (A1 - A2)
Setting accuracy-full range	%	± 5	± 5	± 5
Electrical life at rated load in AC1	cycles	50 · 10 <sup>3</sup>	60 · 10 <sup>3</sup>	100 · 10 <sup>3</sup>
Ambient temperature range	°C	-20...+60 <sup>(1)</sup>	-20...+60 <sup>(1)</sup>	-20...+60 <sup>(1)</sup>
Protection category		IP 20	IP 20	IP 20

**Approvals** (according to type)



**Mono-function and multi-function timer range**

**Type 83.82**

- Star-Delta, multi-voltage, star and delta output contacts

**Type 83.91**

- Asymmetrical flasher, multi-voltage, 1 Pole

- 22.5 mm wide
- Time scales:  
Type 83.82/83.91 - 0.05 s to 10 days
- Wide supply range (24...240)V AC / DC
- 35 mm rail (EN 60715) mount
- Complies with EN 45545-2:2013 (protection against fire of materials), EN 61373 (resistance against random vibrations and shock, Category 1, Class B), EN 50155 (resistance to temperature and humidity, T1 class)

\* (0.05...1)s, (0.5...10)s, (0.05...1)min, (0.5...10)min, (0.05...1)h, (0.5...10)h, (0.05...1)d, (0.5...10)d

\*\* 0.05 s, 0.2 s, 0.3 s, 0.45 s, 0.6 s, 0.75 s, 0.85 s, 1 s

<sup>(1)</sup> Short term (10 min) + 70°C  
For outline drawing see page 9

**Contact specification**

Contact configuration		2 NO (DPST-NO)	1 CO (SPDT)
Rated current/Maximum peak current	A	16/30	16/30
Rated voltage/Maximum switching voltage	V AC	250/400	250/400
Rated load AC1	VA	4000	4000
Rated load AC15 (230 V AC)	VA	750	750
Single phase motor rating (230 V AC)	kW	0.5	0.5
Breaking capacity DC1: 24/110/220 V	A	16/0.3/0.12	16/0.3/0.12
Minimum switching load	mW (V/mA)	300 (5/5)	300 (5/5)
Standard contact material		AgNi	AgNi

**Supply specification**

Nominal voltage (U <sub>N</sub> )	V AC (50/60 Hz)	24...240	24...240
	V DC	24...240	24...240
Rated power AC/DC	VA (50 Hz)/W	< 1.5/< 2	< 1.5/< 2
Operating range	V AC	16.8...265	16.8...265
	V DC	16.8...265	16.8...265

**Technical data**

Specified time range		*	
Repeatability	%	± 1	± 1
Recovery time	ms	200	200
Minimum control impulse	ms	—	50
Setting accuracy-full range	%	± 5	± 5
Electrical life at rated load in AC1	cycles	50 · 10 <sup>3</sup>	50 · 10 <sup>3</sup>
Ambient temperature range	°C	-20...+60 <sup>(1)</sup>	-20...+60 <sup>(1)</sup>
Protection category		IP 20	IP 20

**Approvals** (according to type)

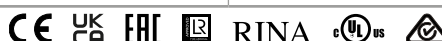

**83.82**



- Multi-voltage
- Mono-function
- 2 pole
- Transfer time can be regulated (0.05...1)s\*\*

**SD:** Star-delta

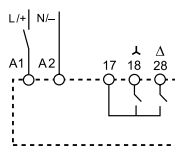

**83.91**



- Multi-voltage
- Multi-function

- LI:** Asymmetrical flasher (starting pulse on)
- LE:** Asymmetrical flasher (starting pulse on) with control signal
- PI:** Asymmetrical flasher (starting pulse off)
- PE:** Asymmetrical flasher (starting pulse off) with control signal

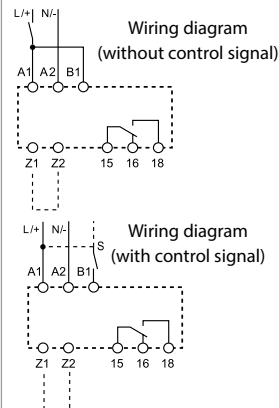

**Multi-function timer and IECEx - Ex - HazLoc multi-function modular timer**

**Type 83.02**

- Multi-function & multi-voltage
- 2 Pole (timed + instantaneous options), external time setting potentiometer option

**Type 83.02.0.240.0003**

- Multi-function & multi-voltage IECEx, Ex (Zone 2, Category 3), HazLoc (Cl I, Div.2) timer
- 2 Pole (timed + instantaneous options), external time setting potentiometer option
- 22.5 mm wide
- Eight time scales from 0.05 s to 10 days
- High input/output isolation
- Wide supply range (24...240)V AC/DC
- 35 mm rail (EN 60715) mount
- "Blade + cross" - both flat blade and cross head screw drivers can be used to adjust the range and function selectors, the timing trimmer, and to disengage the rail mounting clip
- Multi-voltage versions with "PWM clever" technology
- Complies with EN 45545-2:2013 (protection against fire of materials), EN 61373 (resistance against random vibrations and shock, Category 1, Class B), EN 50155 (resistance to temperature and humidity, T1 class)

<sup>(1)</sup> Short term (10 min) + 70°C  
For outline drawing see page 9

**Contact specification**

Contact configuration		2 CO (DPDT)
Rated current/Maximum peak current	A	12/30
Rated voltage/ Maximum switching voltage	V AC	250/400
Rated load AC1	VA	3000
Rated load AC15 (230 V AC)	VA	750
Single phase motor rating (230 V AC)	kW	0.5
Breaking capacity DC1: 24/110/220 V	A	12/0.3/0.12
Minimum switching load	mW (V/mA)	300 (5/5)
Standard contact material		AgNi

**Supply specification**

Nominal voltage (U <sub>N</sub> )	V AC (50/60 Hz)	24...240
	V DC	24...240
Rated power AC/DC	VA (50 Hz)/W	< 2/< 2
Operating range	V AC	16.8...265
	V DC	16.8...265

**Technical data**

Specified time range		(0.05...1)s, (0.5...10)s, (0.05...1)min, (0.5...10)min, (0.05...1)h, (0.5...10)h, (0.05...1)d, (0.5...10)d
Repeatability	%	± 1
Recovery time	ms	200
Minimum control impulse	ms	50
Setting accuracy-full range	%	± 5
Electrical life at rated load in AC1	cycles	60 · 10 <sup>3</sup>
Ambient temperature range	°C	-20...+60 <sup>(1)</sup>
Protection category		IP 20

**Approvals** (according to type)

**83.02**



- Multi-voltage
- Multi-function
- Timing can be regulated using ext. Potentiometer
- 2 timed contacts or 1 timed + 1 instantaneous contact

- AI:** On-delay
- DI:** Interval
- GI:** Pulse delayed
- SW:** Symmetrical flasher (starting pulse on)
- BE:** Off-delay with control signal
- CE:** On- and off-delay with control signal
- DE:** Interval with control signal on
- WD:** Watchdog (Retriggerable interval with control signal on)

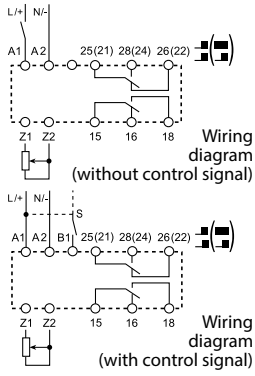

**NEW 83.02 - 0003**



- IECEx - Ex - HazLoc
- Multi-voltage and Multi-function
- Timing can be regulated using ext. Potentiometer
- 2 timed contacts or 1 timed + 1 instantaneous contact

- AI:** On-delay
- DI:** Interval
- GI:** Pulse delayed
- SW:** Symmetrical flasher (starting pulse on)
- BE:** Off-delay with control signal
- CE:** On- and off-delay with control signal
- DE:** Interval with control signal on
- WD:** Watchdog (Retriggerable interval with control signal on)

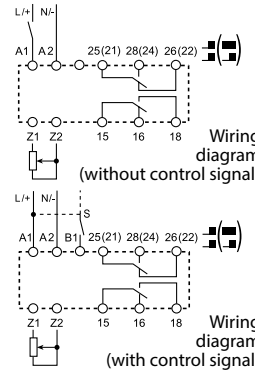

## Ordering information

Example: 83 series, modular timers, 1 CO (SPDT) - 16 A, supply rated at (24...240)V AC/DC.

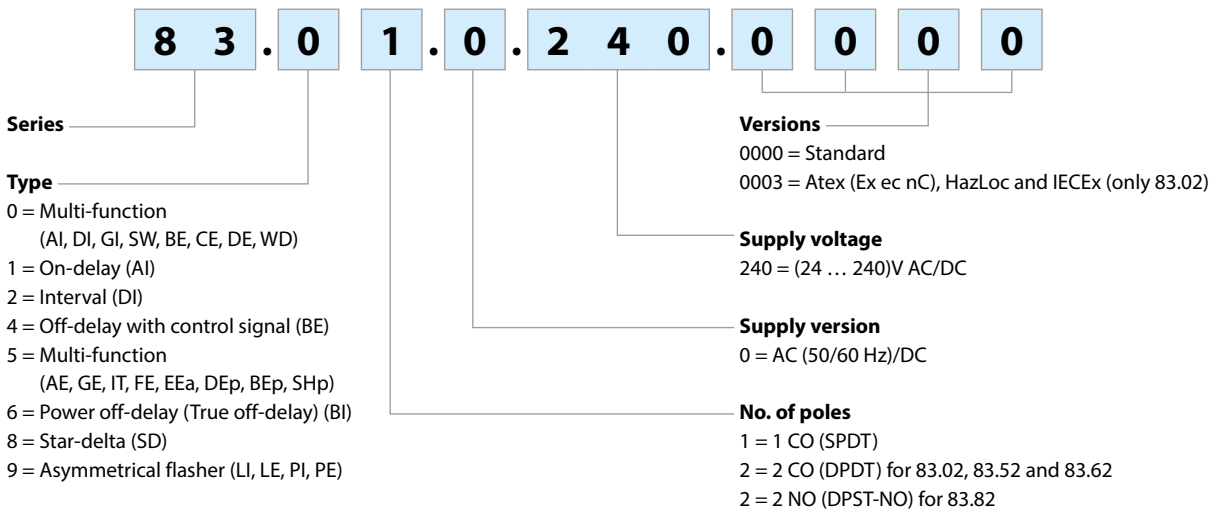

## Technical data

Insulation					
Dielectric strength	between input and output circuit	V AC	4000		
	between open contacts	V AC	1000		
Insulation (1.2/50 μs) between input and output		kV	6		
EMC specifications					
Type of test		Reference standard	83.01/02/52/11/21/41/82/91	83.62	
Electrostatic discharge	contact discharge	EN 61000-4-2	4 kV	4 kV	
	air discharge	EN 61000-4-2	8 kV	8 kV	
Radio-frequency electromagnetic field	(80 ÷ 1000 MHz)	EN 61000-4-3	10 V/m	10 V/m	
	(1000 ÷ 2700 MHz)	EN 61000-4-3	3 V/m	3 V/m	
Fast transients (burst) (5-50 ns, 5 and 100 kHz)	on Supply terminals	EN 61000-4-4	7 kV	6 kV	
	on control signal terminal (B1)	EN 61000-4-4	7 kV	6 kV	
Surges (1.2/50 μs) on Supply terminals	common mode	EN 61000-4-5	6 kV	6 kV	
	differential mode	EN 61000-4-5	6 kV	4 kV	
	on control signal terminal (B1)	common mode	EN 61000-4-5	6 kV	6 kV
		differential mode	EN 61000-4-5	4 kV	4 kV
Radio-frequency common mode	(0.15 ÷ 80 MHz)	EN 61000-4-6	10 V	10 V	
	on Supply terminals (80 ÷ 230 MHz)	EN 61000-4-6	10 V	10 V	
Radiated and conducted emission		EN 55022	class A	class A	
Other data					
Current absorption on control signal (B1)		< 1 mA			
- max cable length (capacity of ≤ 10 nF/100 m)		150 m			
- when applying a control signal to B1, which is different from the supply voltage at A1/A2		B1 is isolated from A1 and A2 by an opto-coupler, and can therefore be operated at a voltage other than the supply voltage. If using a control signal of between (24... 48)V DC and a supply voltage of (24...240)V AC, ensure that the signal - is connected to A2 and the + is applied to B1, and that L is applied to B1 and N to A2.			
External potentiometer for 83.02/52		Use a 10 kΩ / ≥ 0.25 W linear potentiometer. Maximum cable length 10 m. When using an external potentiometer, the timer automatically use its setting in place of the internal setting. Consider the voltage potential at the potentiometer to be the same as the timer supply voltage.			
Power lost to the environment	without contact current	W	1.4		
	with rated current	W	3.2		
Screw torque		Nm	0.8		
Max. wire size			solid cable	stranded cable	
			mm <sup>2</sup>	1 x 6 / 2 x 4	1 x 4 / 2 x 2.5
			AWG	1 x 10 / 2 x 12	1 x 12 / 2 x 14

Markings - Type 83.02...0003 - ATEX, IECEx and HazLoc versions

<b>ATEX (UL 23 ATEX 3005 X):</b>	II 3 G	
<b>IECEX (IECEX ULD 23.0013 X):</b>	Ex ec nC IIC T4 Gc	
<b>Haz.Loc. (E497395):</b>	Cl I, Div2, Gr A, B, C, D, T4 Cl I, Zn 2, AEx ec nC IIC T4 Ex ec nC IIC T4 Gc X	
Specific marking of explosion protection		
<b>II</b>	Component for surface plant (different from mines)	
<b>3</b>	Category 3: normal level of protection	
<b>G - Cl I</b>	Explosive atmosphere due to presence of combustible gas vapour or mist	
<b>Div 2 - Zn 2</b>	Hazardous explosive concentration presence just in case of fault	
<b>Ex ec - AEx ec</b>	Increased safety	
<b>Ex nC - AEx nC</b>	Sealed device	
<b>IIC - Gr A, B, C, D</b>	Gas group	
<b>T4</b>	Temperature class	
<b>Gc</b>	Device protection level	
<b>-20°C ≤ Ta ≤ +55°C</b> Ambient temperature range		
<b>UL 23 ATEX 3005 X - IECEx ULD 23.0013 X - E497395</b> UL - ULD: ID of the notified body which issues the type certificate 23: year of issue of the certificate 3005 - 0013: number of the type certificate E497395: UL file number X: special instruction for use		
<b>Zyy: production batch identification</b> Z: year, yy: week		

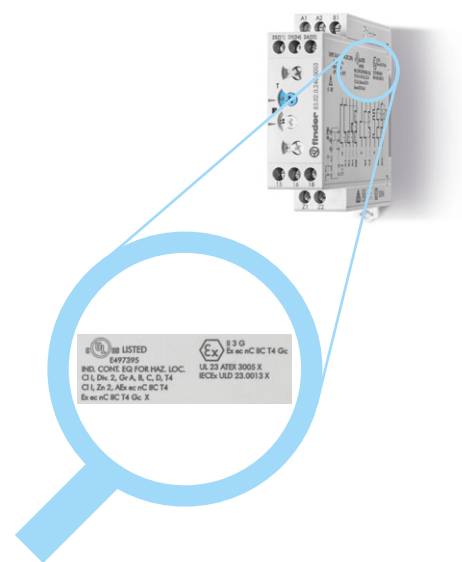

Outline drawings

Type 83.01  
Screw terminal

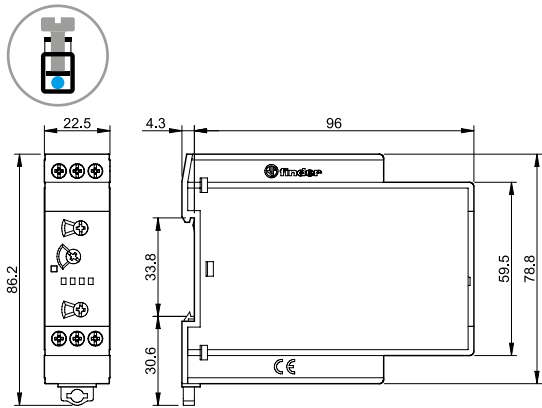

Types 83.02/52  
Screw terminal

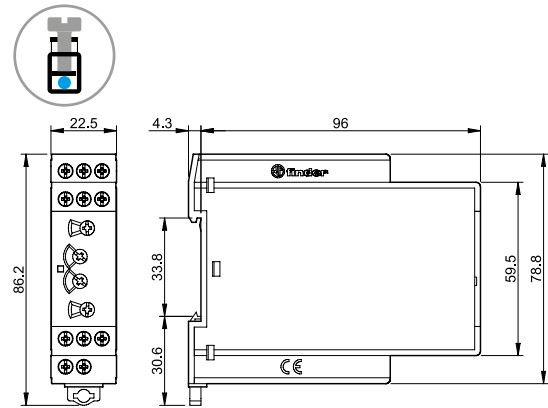

Type 83.11  
Screw terminal

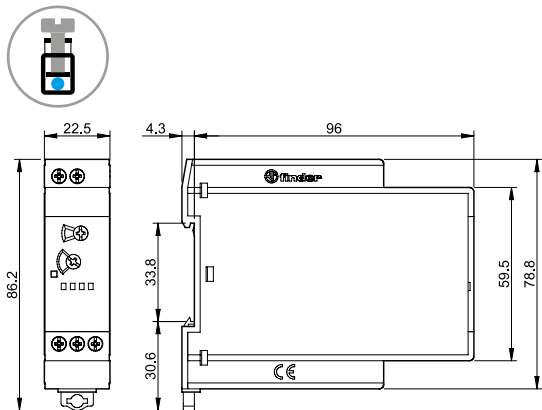

Type 83.21  
Screw terminal

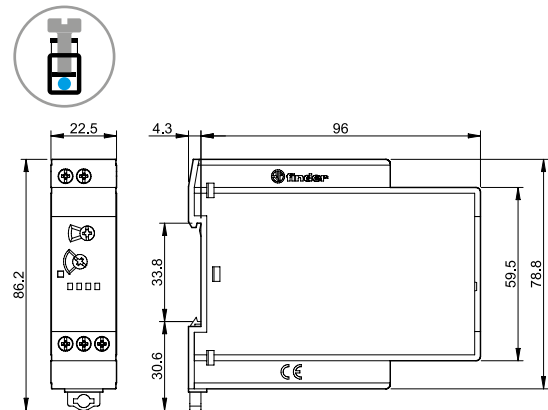

Type 83.41  
Screw terminal

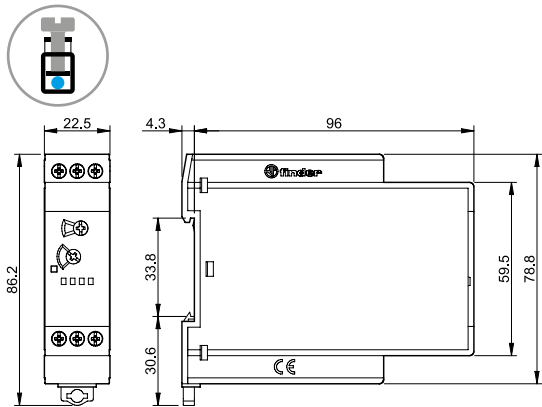

Type 83.62  
Screw terminal

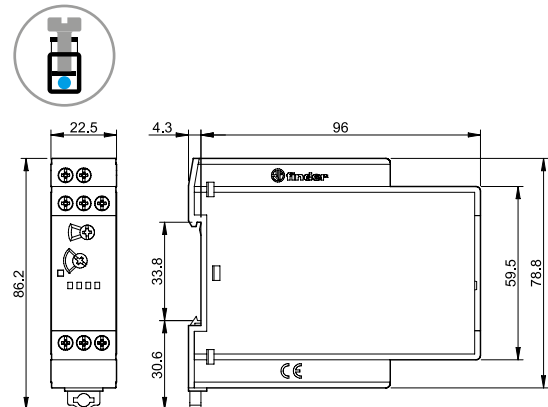

Type 83.82  
Screw terminal

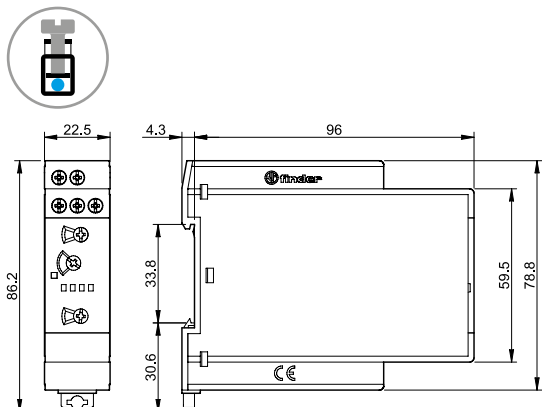

Type 83.91  
Screw terminal

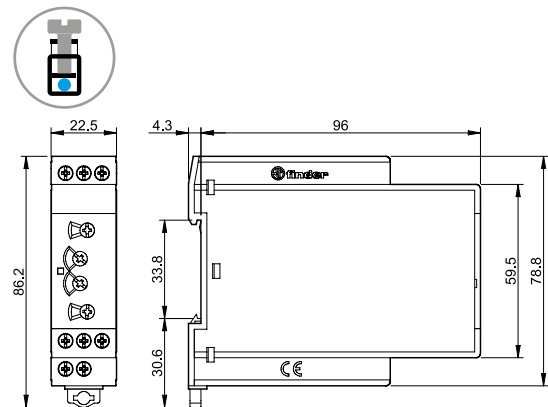

Accessories

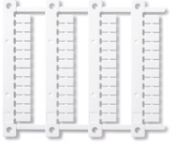

060.48

<b>Sheet of marker tags (CEMBRE Thermal transfer printers)</b> for relays types 83.01/11/21/41/62/82, plastic, 48 tags, 6 x 12 mm	060.48
---	--------



087.02.2

<b>Potentiometer</b> usable as external potentiometer for type 83.02/52 10 kΩ / 0.25 W linear, IP 66	087.02.2
---	----------

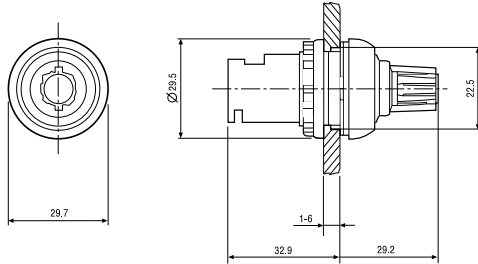
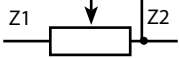

Functions

LED*	Supply voltage	NO output contact	Contacts	
			Open	Closed
	OFF	Open	15 - 18 25 - 28	15 - 16 25 - 26
	ON	Open	15 - 18 25 - 28	15 - 16 25 - 26
	ON	Open (Timing in Progress)	15 - 18 25 - 28	15 - 16 25 - 26
	ON	Closed	15 - 16 25 - 26	15 - 18 25 - 28

\* The LED on type 83.62 is illuminated when supply voltage is supplied to timer.

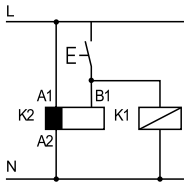

• Possible to control an external load, such as another relay coil or timer, connected to the control signal terminal B1.

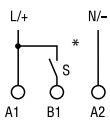

\* With DC supply, positive polarity has to be connected to B1 terminal (according to EN 60204-1).

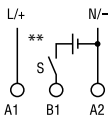

\*\* A voltage other than the supply voltage can be applied to the control signal (B1), example:  
A1 - A2 = 230 V AC  
B1 - A2 = 12 V DC



## Functions

### Wiring diagram

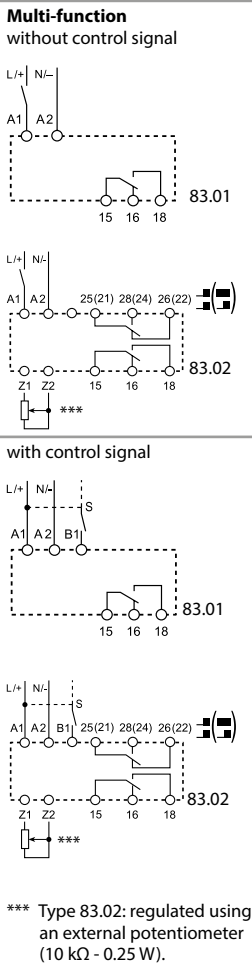

U = Supply voltage

S = Signal switch

= Output contact

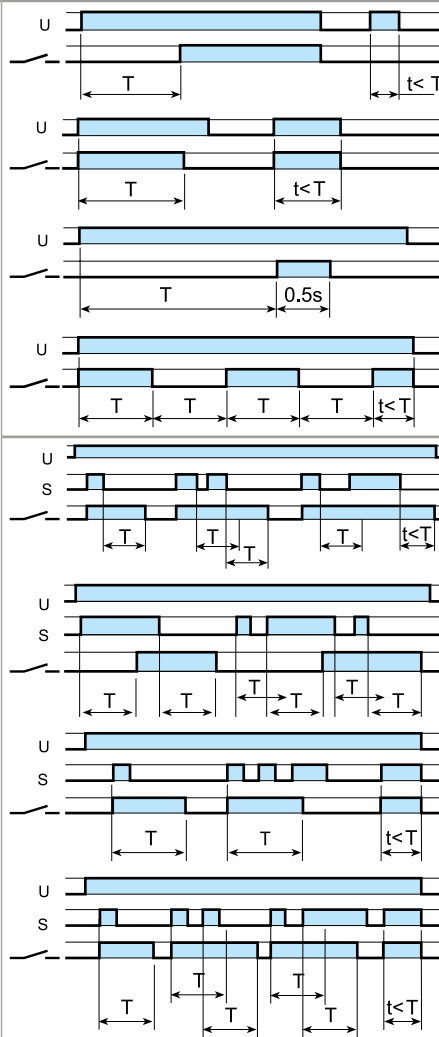

**(AI) ON-delay.**  
Apply power to timer. Output contacts transfer after preset time has elapsed. Reset occurs when power is removed.

**(DI) Interval.**  
Apply power to timer. Output contacts transfer immediately. After the preset time has elapsed, contacts reset.

**(GI) Pulse delayed.**  
Apply power to timer. Output contacts transfer after preset time has elapsed. Reset occurs after a fixed time of 0.5s.

**(SW) Symmetrical flasher (starting pulse ON).**  
Apply power to timer. Output contacts transfer immediately and cycle between ON and OFF for as long as power is applied. The ratio is 1:1 (time on = time off).

**(BE) OFF-delay with control signal.**  
Power is permanently applied to the timer. The output contacts transfer immediately on closure of the control signal (S). Opening the control signal initiates the preset delay, after which time the output contacts reset.

**(CE) ON- and OFF-delay with control signal.**  
Power is permanently applied to the timer. Closing the control signal (S) initiates the preset delay, after which time the output contacts transfer. Opening the control signal initiates the same preset delay, after which time the output contacts reset.

**(DE) Interval with control signal ON.**  
Power is permanently applied to the timer. On momentary or maintained closure of control signal (S), the output contacts transfer, and remain so for the duration of the preset delay, after which they reset.

**(WD) Watchdog (Retriggerable interval with control signal ON).**  
Power is permanently applied to the timer. On momentary or maintained closure of control signal (S), the output contacts transfer, and remain so for the duration of the preset delay, after which they reset; subsequent closures of control signal during the delay will extend the time. If the closure of the control signal (S) is longer than the preset time (T) then the output contacts reset.

NOTE: The timing function must be set when the timer is de-energised. Or for the 83.02/52, when the contact mode selector is in the OFF position.

### 83.02 type

Contact mode selector	Functions without control signal (example: AI)	Functions with control signal (example: BE)
2 timed contacts 	<p>Both output contacts (15-18 and 25-28) follow the timing function</p>	<p>Both output contacts (15-18 and 25-28) follow the timing function</p>
OFF 	<p>Both output contacts [15-18 and 25(21)-28(24)] stay permanently open</p>	<p>Both output contacts [15-18 and 25(21)-28(24)] stay permanently open</p>
1 timed + 1 instantaneous contact 	<p>The output contact 15-18 follows the timing function The output contact 21-24 follows the power supply (U)</p>	<p>The output contact 15-18 follows the timing function The output contact 21-24 follows the control signal (S)</p>

Functions

Wiring diagram

Multi-function with control signal

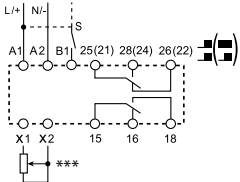

\*\*\* Regulated using an external potentiometer (10 kΩ - 0.25 W).

with control signal and pause signal

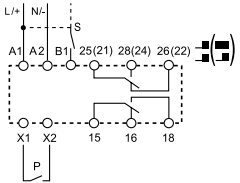

Type 83.52

U = Supply voltage S = Signal switch P = Pause switch = Output contact

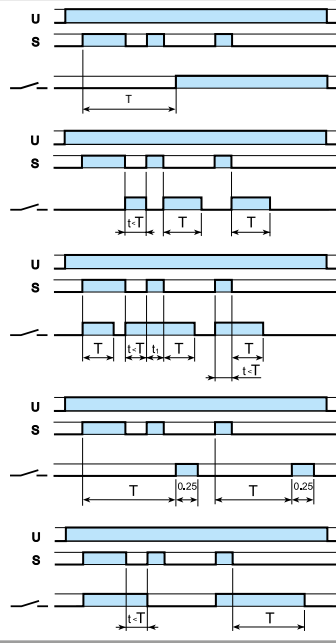

**(AE) ON-delay with control signal.**  
Power is permanently applied to the timer. Closing the Signal Switch (S) initiates the preset delay, after which times the output contacts transfer and remain so until the power is removed.

**(EEa) Interval with control signal OFF (retriggerable).**  
Power is permanently applied to the timer. On opening of the Signal Switch (S) the output contacts transfer, and remain so for the duration of the preset delay, after which they reset.

**(FE) Interval with control signal ON and OFF.**  
Power is permanently applied to the timer. Both the opening and the closing of the Signal Switch (S) initiates the transfer of the output contacts. In both instances the contacts reset after the preset delay has elapsed.

**(GE) Pulse delayed with control signal ON.**  
Power is permanently applied to the timer. Closing the Signal Switch (S) initiates the preset delay, after which the output contacts transfer. Reset occurs after a fixed time of 0.25 s.

**(IT) Timing step.**  
Closing the Signal Switch (S) the output contacts transfer and remain so, after S opening, for the duration of the preset delay, after which they reset. During the timing period it is possible to immediate open the contact with a further impulse on S.

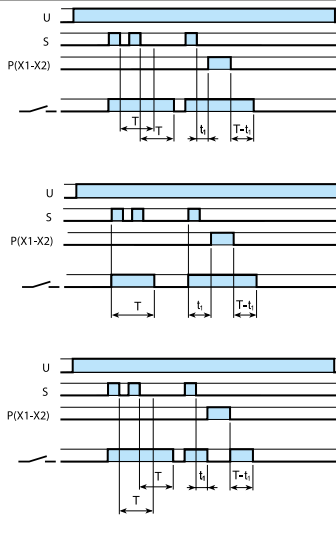

**(BEp) OFF-delay with control signal and pause signal.**  
Power is permanently applied to the timer. The output contacts transfer immediately on closure of the Signal Switch (S). Opening the signal switch initiates the preset delay, after which the output contacts reset. Closure of the pause switch (X1-X2) will immediately halt the timing process, but the elapsed time will be retained. The current state of the output contacts will be maintained. On opening of the pause switch, timing resumes from the retained value.

**(DEp) Interval with control signal ON and pause signal.**  
Power is permanently applied to the timer. On momentary or maintained closure of Signal Switch (S), the output contacts transfer, and remain so for the duration of the preset delay, after which they reset. Closure of the pause switch (X1-X2) will immediately halt the timing process, but the elapsed time will be retained. The current state of the output contacts will be maintained. On opening of the pause switch, timing resumes from the retained value.

**(SHp) "Shower" function (OFF-delay with control signal and pause signal).**  
Power is permanently applied to the timer. The output contacts transfer immediately on closure of the Signal Switch (S). Opening the signal switch initiates the preset delay, after which the output contacts reset. Closure of the pause switch (X1-X2) will immediately halt the timing process, but the elapsed time will be retained. During the pause, the output contacts 15-18 and 25-28 will be open. On opening of the pause switch, timing resumes from the retained value and the output contacts will take the previous condition.

83.52 type

Contact mode selector	Functions with control signal and pause signal (example: BEp)	Function SHp
2 timed contacts 	<p>Both output contacts (15-18 and 25-28) follow the timing function</p>	<p>Both output contacts (15-18 and 25-28) follow the timing function</p>
OFF 	<p>Both output contacts [15-18 and 25(21)-28(24)] stay permanently open</p>	<p>Both output contacts [15-18 and 25(21)-28(24)] stay permanently open</p>
1 timed + 1 instantaneous contact 	<p>The output contact 15-18 follows the timing function The output contact 21-24 follows the control signal (S)</p>	<p>The output contact 15-18 follows the timing function. The output contact 21-24 is always open, unless during the pause, when is closed</p>

## Functions

### Wiring diagram

		U = Supply voltage	S = Signal switch	= Output contact
<b>Mono-function without control signal</b>   83.11 83.21  83.62  83.82	<b>Type 83.11</b>			<b>(AI) ON-delay.</b> Apply power to timer. Output contacts transfer after preset time has elapsed. Reset occurs when power is removed.
	<b>83.21</b>			<b>(DI) Interval.</b> Apply power to timer. Output contacts transfer immediately. After the preset time has elapsed, contacts reset.
	<b>83.62</b>			<b>(BI) Power OFF-delay (True OFF-delay).</b> Apply power to timer (minimum 500 ms). Output contacts transfer immediately. Removal of power initiates the preset delay, after which time the output contacts reset.
	<b>83.82</b>			<b>(SD) Star-delta.</b> Apply power to timer. The star contact ( $\lambda$ ) closes immediately. After preset delay has elapsed the star contact ( $\lambda$ ) resets. After a further time (settable from 0.05 s to 1 s) the delta contact ( $\Delta$ ) closes and remains in that position, until reset on power off.
<b>with control signal (S)</b>   83.41	<b>83.41</b>			<b>(BE) OFF-delay with control signal.</b> Power is permanently applied to the timer. The output contacts transfer immediately on closure of the control signal (S). Opening the control signal initiates the preset delay, after which time the output contacts reset.
<b>Asymmetrical recycler without control signal</b>   83.91  Z1-Z2 open: <b>(LI)</b> function Z1-Z2 linked: <b>(PI)</b> function  <b>with control signal</b>   83.91  Z1-Z2 open: <b>(LE)</b> function Z1-Z2 linked: <b>(PE)</b> function	<b>83.91</b>			<b>(LI) Asymmetrical flasher (starting pulse ON) - (Z1-Z2 open).</b> Apply power to timer. Output contacts transfer immediately and cycle between ON and OFF for as long as power is applied. The ON and OFF times are independently adjustable.
				<b>(PI) Asymmetrical flasher (starting pulse OFF) - (Z1-Z2 linked).</b> Apply power to timer. Output contacts transfer after time T1 has elapsed and cycle between OFF and ON for as long as power is applied. The ON and OFF times are independently adjustable.
				<b>(LE) Asymmetrical flasher (starting pulse ON) with control signal - (Z1-Z2 open).</b> Power is permanently applied to the timer. Closing control signal (S) causes the output contacts to transfer immediately and cycle between ON and OFF, until opened.
				<b>(PE) Asymmetrical flasher (starting pulse OFF) with control signal - (Z1-Z2 linked).</b> Power is permanently applied to the timer. Closing the control signal (S) initiates delay T1 after which the output contacts transfer and continue to cycle between OFF and ON, until the control signal is opened.

## Times scales

Rotary switch position 83 series

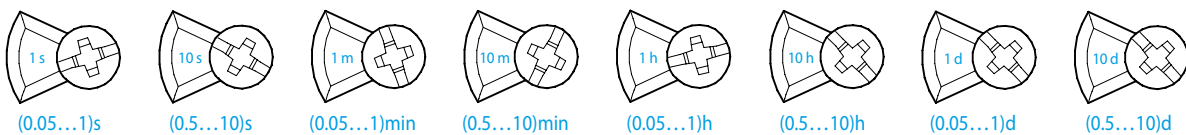



# SMARTimer, digital timer 16 A



Timers and  
lighting controls



Automatic  
car-washes



Labelling  
machines



Industrial  
furnaces  
and ovens



Punches,  
cleaners, planers  
and sanders



Discotheques,  
swimming pools  
and fountains



84  
SERIES



**Multi-function SMARTimer**

**Type 84.02**

- 1 CO (16 A) + 1 CO (16 A)
- 2 in 1: two independent channels
- Two supply version available: 12...24 V AC/DC and 110...240 V AC/DC (not polarized)
- Two programming modes: "Smart" mode via smartphone with NFC communication or "Classic" mode via the joystick
- Wide backlit display for easy reading all information during the programming phase and during normal operation
- Flexibility: possible to create new specific functions, mixing the 30 available functions on each channel
- High precision and possibility of choice in time set-up:
  - Time units: 0.1 seconds, seconds, minutes, hours
  - Set-time to 4 digits, anywhere between 000.1 second and 9999 hours
- Large display allows easy viewing: set time, current time, timing in progress, input command state, output state
- Two independent Start inputs - one per channel
- One common Reset input (select to apply to either, or both, channels)
- One common Pause input (select to apply to either, or both, channels)
- PIN to protect access to programming session
- Up or Down timing modes
- Type 84.02.0.024.0000: it's possible to directly connect timer input to proximity sensors (both PNP and NPN)
- 35 mm rail (EN 60715) mount

Screw terminal



For outline drawing see page 5

**84.02**



- 2 CO 16 A output contacts
- Digital Timer "Two in one": two totally independent programmable channels, in a single product

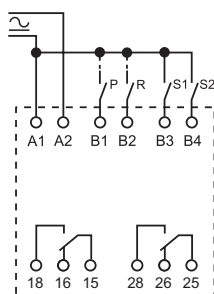

Wiring diagram

**Contact specification**

Contact configuration	2 CO (DPDT)	
Rated current/Maximum peak current	A	16/30
Rated voltage/Maximum switching voltage	V AC	250/400
Rated load AC1	VA	4000
Rated load AC15 (230 V AC)	VA	1000
Single phase motor rating (230 V AC)	kW	0.55
Breaking capacity DC1: 24/110/220 V	A	16/0.3/0.12
Minimum switching load	mW (V/mA)	300 (5/5)
Standard contact material	AgNi	

**Supply specification**

Nominal voltage (U <sub>N</sub> )	V DC/AC (50/60 Hz)	12...24	110...240
Rated power AC/DC	VA (50 Hz)/W	2.2/1.2	4/1.6
Operating range	V DC/AC	10...30	90...264

**Technical data**

Specified time range	0.1s...9999h	
Repeatability	%	± 0.05
Recovery time	ms	40*
Minimum control impulse	ms	40
Setting accuracy	%	± 0.05
Electrical life at rated load in AC1	cycles	100 · 10 <sup>3</sup>
Ambient temperature range	°C	-20...+50
Protection category	IP 20	

**Approvals (according to type)**



\* Applies where timer function is controlled by an input to B terminal(s). Where power-off is used to reset the timer, the recovery time can increase up to 500 ms, depending on supply voltage.

## Ordering information

Example: 84 series, SMARTimer, 2 CO - 16 A, supply rated at (110...240)V AC/DC.

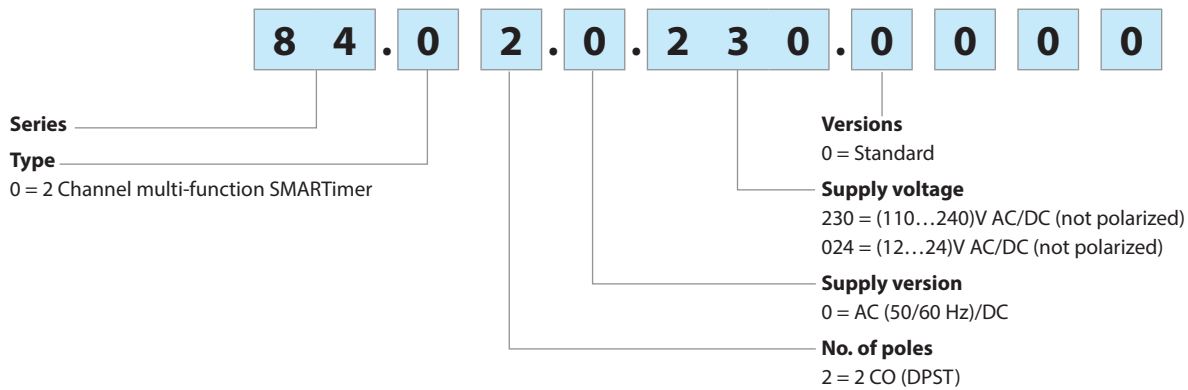

## Technical data

Insulation					
Dielectric strength	between input and output circuit	V AC	4000		
	between open contacts	V AC	1000		
	between input/output and display	V AC	2000		
Insulation (1.2/50 µs) between input and output		kV	6		
EMC specifications					
Type of test		Reference standard	84.02.0.230	84.02.0.024	
Electrostatic discharge	contact discharge	EN 61000-4-2	4 kV	4 kV	
	air discharge	EN 61000-4-2	8 kV	8 kV	
Radio-frequency electromagnetic field (80 ÷ 1000 MHz)		EN 61000-4-3	10 V/m	10 V/m	
Fast transients (burst) (5-50 ns, 5 kHz) on Supply terminals		EN 61000-4-4	4 kV	4 kV	
Surges (1.2/50 µs) on Supply terminals	common mode	EN 61000-4-5	4 kV	2 kV	
	differential mode	EN 61000-4-5	4 kV	1.5 kV	
	on start terminal (B1...B4)	common mode	EN 61000-4-5	4 kV	2 kV
	differential mode	EN 61000-4-5	3 kV	1 kV	
Radio-frequency common mode (0.15 ÷ 80 MHz) on Supply terminals		EN 61000-4-6	10 V	10 V	
Radiated and conducted emission		EN 55022	class B	class B	
Other data					
Current absorption on control terminals (B1...B4)			< 2.4 mA (0.230), < 5.5 mA (0.024)		
Power lost to the environment	without contact current	W	1.6		
	with rated current	W	3.6		
 Screw torque		Nm	0.8		
Max. wire size			solid cable	stranded cable	
		mm <sup>2</sup>	1 x 6 / 2 x 4	1 x 4 / 2 x 2.5	
		AWG	1 x 10 / 2 x 12	1 x 12 / 2 x 14	



## Outline drawing

Type 84.02  
Screw terminal

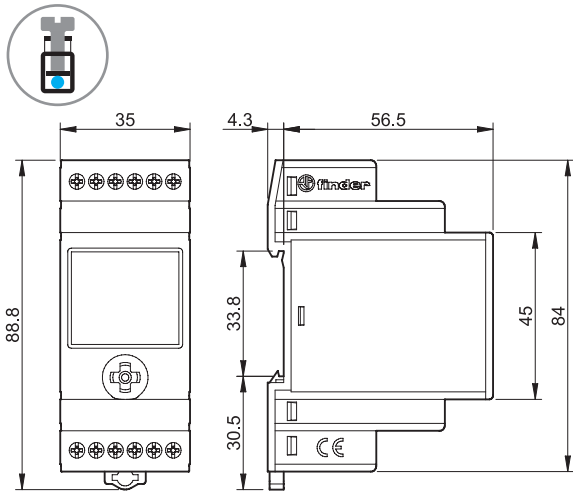

## Two programming modes

### “Smart”

Mode via smartphones with NFC communication using Finder toolbox Android App.



### “Classic”

Mode via the joystick

Android, Google Play and the Google Play logo are trademarks of Google Inc. Apple is a trademark of Apple Inc. App Store is a service mark of Apple Inc.

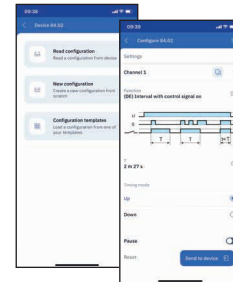

### Finder Toolbox for programming

Once the App FINDER Toolbox is downloaded and installed, you can read an existing program, or program your device with maximum flexibility, changing the smallest details and saving your program directly to your smartphone.

At this point you simply touch the time switch with the smartphone to transfer the data.

### Finder Toolbox for reference

Finder Toolbox provides all technical data sheets and news from Finder.

## Functions

### Wiring diagram

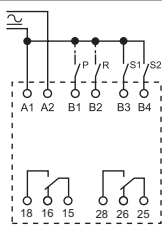

Type  
84.02

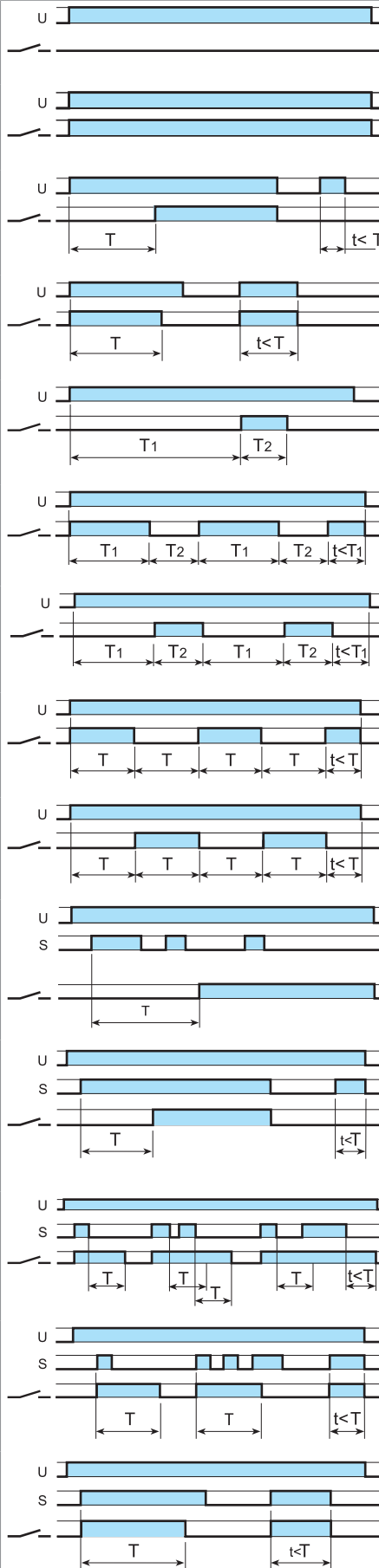

**(OFF) Relay OFF.**

The output contact stays permanently open.

**(ON) Relay ON.**

The output contact stays permanently closed.

**(AI) On-delay.**

Apply power to timer. Output contact transfers after preset time has elapsed. Reset occurs when power is removed.

**(DI) Interval.**

Apply power to timer. Output contact transfers immediately. After the preset time has elapsed, contact resets.

**(GI) Pulse delayed.**

Apply power to timer. Output contact transfers after time T1 has elapsed. Reset occurs after T2 time.

**(LI) Asymmetrical flasher (starting pulse on).**

Apply power to timer. Output contact transfers immediately and cycle between ON and OFF for as long as power is applied. The ON and OFF times are independently adjustable.

**(PI) Asymmetrical flasher (starting pulse off).**

Apply power to timer. Output contact transfers after time T1 has elapsed and cycle between OFF and ON for as long as power is applied. The ON and OFF times are independently adjustable.

**(SW) Symmetrical flasher (starting pulse on).**

Apply power to timer. Output contact transfers immediately and cycle between ON and OFF for as long as power is applied. The ratio is 1:1 (time on = time off).

**(SP) Symmetrical flasher (starting pulse off).**

Apply power to timer. First transfer of contact occurs after preset time has elapsed. The timer now cycles between OFF and ON as long as power is applied. The ratio is 1:1 (time on = time off).

**(AE) On-delay with control signal.**

Power is permanently applied to the timer. Closing the Signal Switch (S) initiates the preset delay, after which the output contact transfers and remains so until the power is removed.

**(AC) On-delay with maintained control signal.**

Power is permanently applied to the timer. Closing the Signal Switch (S) initiates the preset delay, after which the output contact transfers and remains so, until the Signal Switch (S) is opened. If the Signal Switch (S) opens during the timing, the function will reset.

**(BE) Off-delay with control signal.**

Power is permanently applied to the timer. The output contact transfers immediately on closure of the Signal Switch (S). Opening the Signal Switch initiates the preset delay, after which the output contact resets.

**(DE) Interval with control signal on.**

Power is permanently applied to the timer. On momentary or maintained closure of Signal Switch (S), the output contact transfers, and remain so for the duration of the preset delay, after which it resets.

**(DC) Interval with maintained control signal.**

Power is permanently applied to the timer. On closure of Signal Switch (S), the output contact transfers and remain so for the duration of the preset delay, unless the Signal Switch opens before the preset time has elapsed in which case the output contact resets immediately.

## Functions

### Wiring diagram

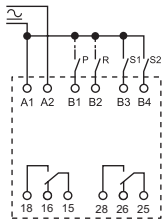

Type  
84.02

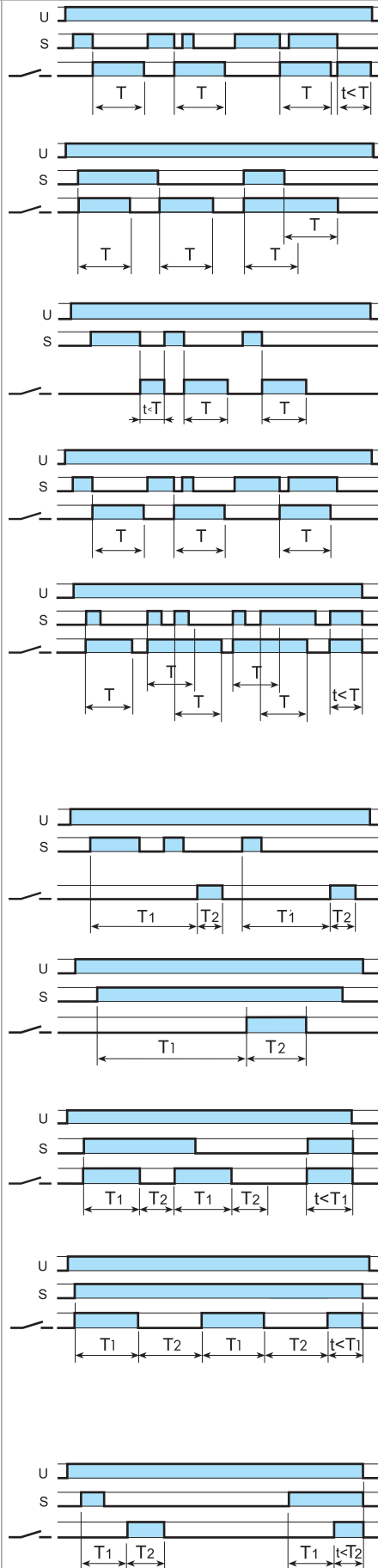

**(EE) Interval with control signal off.**

Power is permanently applied to the timer. On opening of the Signal Switch (S) the output contact transfers, and remain so for the duration of the preset delay, after which it resets.

**(FE) Interval with control signal on and off.**

Power is permanently applied to the timer. Both the opening and the closing of the Signal Switch (S) initiates the transfer of the output contact (or extends the time). In both instances the contact resets after the preset delay has elapsed.

**(EEa) Interval with control signal off (retriggerable).**

Power is permanently applied to the timer. On opening of the Signal Switch (S) the output contact transfers, and remain so for the duration of the preset delay, after which it resets.

**(EEb) Interval with control signal off.**

Power is permanently applied to the timer. On opening of the Signal Switch (S) the output contact transfers, and remain so for the duration of the preset delay, after which it resets.

**(WD) Watchdog**

**(retriggerable interval with control signal on).**

Power is permanently applied to the timer. On momentary or maintained closure of Signal Switch (S), the output contact transfers, and remain so for the duration of the preset delay, after which it resets; subsequent closures of Signal Switch during the delay will extend the time. If the closure of the Signal Switch (S) is longer than the preset time (T) then the output contact resets.

**(GE) Pulse delayed with control signal on.**

Power is permanently applied to the timer. Closing the Signal Switch (S) initiates T1 delay, after which the output contact transfers. Reset occurs after T2 time.

**(GC) Pulse delayed with maintained control signal.**

Power is permanently applied to the timer. On closure of Signal Switch (S), the output contact will transfer after time T1 has elapsed. Reset occurs after T2 time. If the Signal Switch (S) opens during T1 /T2, the timing function/output contact will reset.

**(LE) Asymmetrical flasher (starting pulse on) with control signal.**

Power is permanently applied to the timer. Closing Signal Switch (S) causes the output contact to transfer immediately and cycle between ON and OFF, until opened.

**(LC) Asymmetrical flasher (starting pulse on) with maintained control signal.**

Power is permanently applied to the timer. On closure of Signal Switch (S), the output contact transfers immediately and cycles between ON and OFF for as long as the control signal is applied. The ON and OFF times are independently adjustable. After the Signal Switch (S) is opened, the output contact resets.

**(PE) Asymmetrical flasher (starting pulse off) with control signal.**

Power is permanently applied to the timer. Closing the Signal Switch (S) initiates delay T1 after which the output contact transfers and continues to cycle between OFF and ON, until the Signal Switch is opened.

## Functions

### Wiring diagram

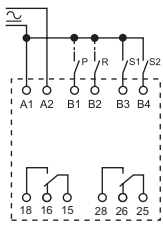

Type  
84.02

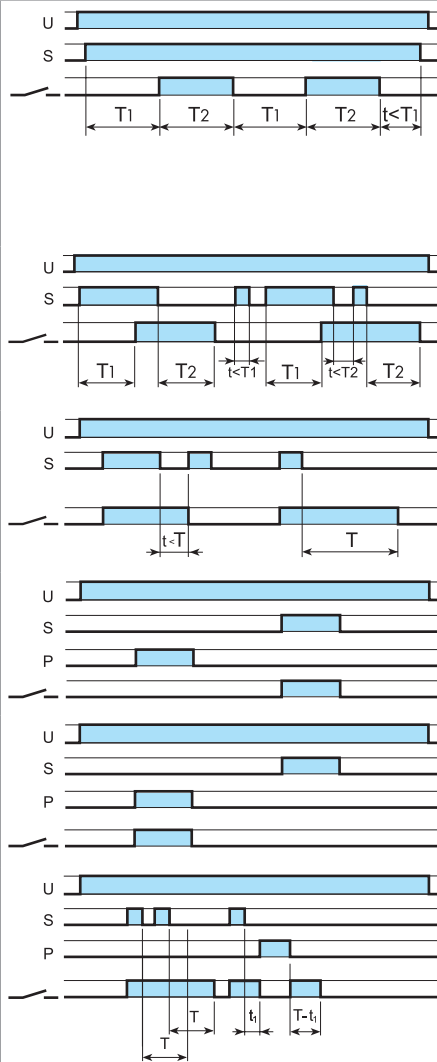

**(PC) Asymmetrical flasher (starting pulse off) with maintained control signal.**

Power is permanently applied to the timer. On closure of Signal Switch (S), the output contact transfers after time  $T_1$  has elapsed and cycles between OFF and ON for as long as the control signal is applied. The OFF and ON times are independently adjustable. After the Signal Switch (S) is opened, the output contact resets.

**(CEb) On and off independent delays with control signal.**

Power is permanently applied to the timer. Closing the Signal Switch (S) initiates the preset delay  $T_1$ , after which the output contact transfers. Opening the Signal switch initiates the preset delay  $T_2$ , after which the output contact resets.

**(IT) Timing step.**

Closing the Signal Switch (S) the output contact transfers and remains so after S opening, for the duration of the preset delay, after which it resets. During the timing period it is possible to immediately open the contact with a further impulse on S.

**(SS) Monostable controlled by Signal switch.**

The output contact follows the status of Signal Switch (S).

**(PS) Monostable controlled by Pause switch.**

The output contact follows the status of Pause Switch (P).

**(SHp) "Shower"  
(off-delay with control signal and pause signal).**

Power is permanently applied to the timer. The output contact transfers immediately on closure of the Signal Switch (S). Opening the signal switch initiates the preset delay, after which the output contact resets. Closure of the Pause Switch (P) will immediately halt the timing process, but the elapsed time will be retained. During the pause, the output contact will be open. On opening of the Pause Switch, timing resumes from the retained value and the output contact will take the previous condition.

## PAUSE and RESET options

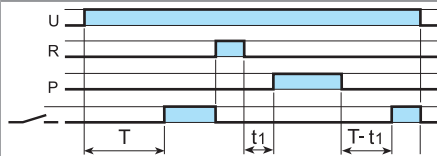

Ex. (AI) function

**(P) PAUSE option\***

Closure of the pause switch will immediately halt the timing process, but the elapsed time will be retained. The current state of the output contacts will be maintained. On opening of the pause switch, timing resumes from the retained value.

**(R) RESET option\***

For each and every function and time range, the timer is immediately reset when the reset switch is closed.

\* Select to apply to either, or both, channels.

## Interfacing the SMARTimer with proximity PNP-NPN sensors

### Wiring diagram

<p>With PNP sensors</p>		
<p>With NPN sensors</p>		<p>It is possible to directly connect the output of proximity sensors (either PNP or NPN types) to the inputs of the 24V version of the SMARTimer.</p>



# Miniature plug-in timers 7 - 10 A



Timers and  
lighting controls



Medical and  
dentistry



Drying kilns



Elevators  
and lifts



Panels for  
electrical  
distribution



Control panels



85  
SERIES





**Plug-in timer**

- 85.02 - 2 Pole 10 A**
- 85.03 - 3 Pole 10 A**
- 85.04 - 4 Pole 7 A**

- Multifunctions
- Seven time scales, from 0.05 s to 100 h
- 94 series sockets for 35 mm rail (EN 60715) mount with push-in and screw terminal

**85.02**



- 2 pole, 10 A
- AC/DC supply non polarized
- Plug-in for use with 94 series sockets

- AI:** On-delay
- DI:** Interval
- SW:** Symmetrical flasher (starting pulse on)
- GI:** Pulse delayed

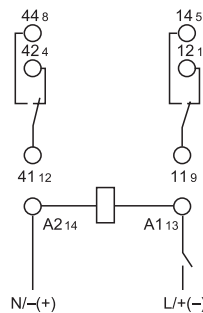

Wiring diagram (without control signal)

**85.03**

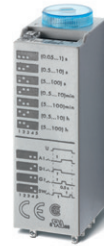

- 3 pole, 10 A
- AC/DC supply non polarized
- Plug-in for use with 94 series sockets

- AI:** On-delay
- DI:** Interval
- SW:** Symmetrical flasher (starting pulse on)
- GI:** Pulse delayed

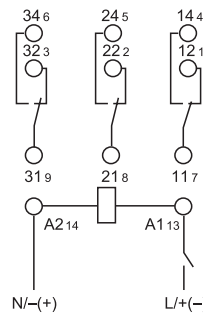

Wiring diagram (without control signal)

**85.04**

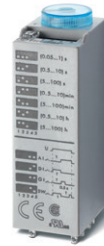

- 4 pole, 7 A
- AC/DC supply non polarized
- Plug-in for use with 94 series sockets

- AI:** On-delay
- DI:** Interval
- SW:** Symmetrical flasher (starting pulse on)
- GI:** Pulse delayed

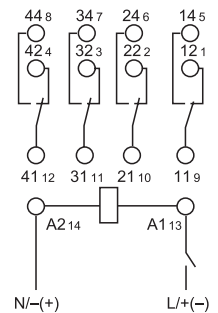

Wiring diagram (without control signal)

FOR UL RATINGS SEE:

"General technical information" page V

For outline drawing see page 4

**Contact specification**

Contact configuration		2 CO (DPDT)	3 CO (3PDT)	4 CO (4PDT)
Rated current/Maximum peak current	A	10/20	10/20	7/15
Rated voltage/Maximum switching voltage	V AC	250/400	250/400	250/250
Rated load AC1	VA	2500	2500	1750
Rated load AC15 (230 V AC)	VA	500	500	350
Single phase motor rating (230 V AC)	kW	0.37	0.37	0.125
Breaking capacity DC1: 24/110/220 V	A	10/0.25/0.12	10/0.25/0.12	7/0.25/0.12
Minimum switching load	mW (V/mA)	300 (5/5)	300 (5/5)	300 (5/5)
Standard contact material		AgNi	AgNi	AgNi

**Supply specification**

Nominal voltage (U <sub>N</sub> )	V AC (50/60 Hz)	230...240	230...240	230...240
	V AC/DC	12 - 24 - 48 - 110...125 (non polarized)		
Rated power AC/DC	VA (50 Hz)/W	2/2	2/2	2/2
Operating range	AC	(0.85...1.1)U <sub>N</sub>	(0.85...1.1)U <sub>N</sub>	(0.85...1.1)U <sub>N</sub>
	DC	(0.85...1.1)U <sub>N</sub>	(0.85...1.1)U <sub>N</sub>	(0.85...1.1)U <sub>N</sub>

**Technical data**

Specified time range		(0.05...1)s, (0.5...10)s, (5...100)s, (0.5...10)min, (5...100)min, (0.5...10)h, (5...100)h		
Repeatability	%	± 2	± 2	± 2
Recovery time	ms	≤ 20	≤ 20	≤ 20
Minimum control impulse	ms	—	—	—
Setting accuracy-full range	%	± 5	± 5	± 5
Electrical life at rated load in AC1	cycles	200 · 10 <sup>3</sup>	200 · 10 <sup>3</sup>	150 · 10 <sup>3</sup>
Ambient temperature range	°C	-20...+60	-20...+60	-20...+60
Protection category		IP 40	IP 40	IP 40

**Approvals** (according to type)



### Ordering information

Example: 85 series timer, 4 CO (4PDT), 24 V AC/DC supply voltage, AI, DI, GI, SW functions.



**Series** ————  
**Type** ————  
 0 = Multifunction (AI, DI, GI, SW)\*  
 \* AI = On-delay  
 DI = Interval  
 GI = Pulse delayed  
 SW = Symmetrical flasher  
 (starting pulse on)

**Supply voltage**  
 012 = 12 V AC/DC  
 024 = 24 V AC/DC  
 048 = 48 V AC/DC  
 125 = (110...125)V AC/DC  
 240 = (230...240)V AC  
**Supply version**  
 0 = AC (50/60 Hz)/DC  
 8 = AC (50/60 Hz) for 240 V only

**No. of poles** ————  
 2 = 2 pole - 10 A  
 3 = 3 pole - 10 A  
 4 = 4 pole - 7 A

### Technical data

Insulation				
Dielectric strength			<b>85.02, 85.03</b>	<b>85.04</b>
	between input and output circuit	V AC	2000	2000
	between open contacts	V AC	1000	1000
	between adjacent contacts	V AC	2000	1550
Insulation (1.2/50 μs) between input and output		kV	6	4
EMC specifications				
<b>Type of test</b>			<b>Reference standard</b>	
Electrostatic discharge	contact discharge		EN 61000-4-2	n.a.
	air discharge		EN 61000-4-2	8 kV
Radio-frequency electromagnetic field (80 ÷ 1000 MHz)			EN 61000-4-3	15 V/m
Fast transients (burst) (5-50 ns, 5 kHz) on Supply terminals			EN 61000-4-4	4 kV
Surges (1.2/50 μs) on Supply terminals	common mode		EN 61000-4-5	4 kV
	differential mode		EN 61000-4-5	2 kV
Radio-frequency common mode (0.15 ÷ 80 MHz) on Supply terminals			EN 61000-4-6	10 V
Power-frequency (50 Hz)			EN 61000-4-8	30 A/m
Radiated and conducted emission			EN 55022	class B
Other data				
Power lost to the environment	without contact current	W	1.6	
	with rated current	W	3.7 (85.02)	4.7 (85.03) 3.6 (85.04)

### Outline drawings

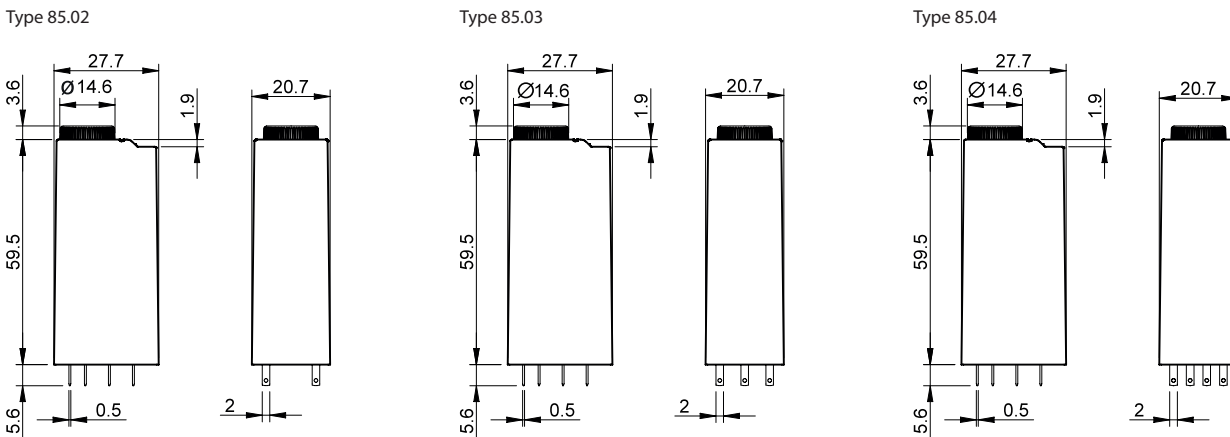

### Times scales

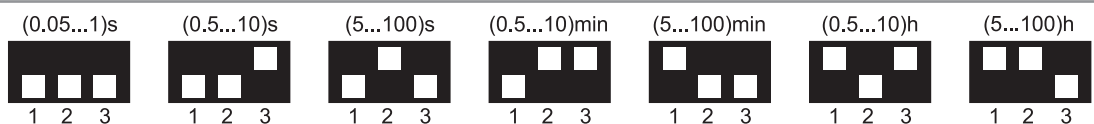

NOTE: time scales and functions must be set before energising the timer.

**Functions**

- U** = Supply voltage
- = Output contact

LED	Supply voltage	NO (SPDT-NO) output contact	Contacts	
			Open	Closed
	OFF	Open	x1 - x4	x1 - x2
	ON	Open	x1 - x4	x1 - x2
	ON	Open (Timing in Progress)	x1 - x4	x1 - x2
	ON	Closed	x1 - x2	x1 - x4

**Wiring diagram**

Type: 85.02, 85.03, 85.04

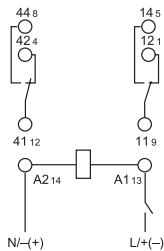

85.02

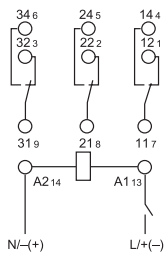

85.03

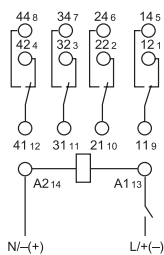

85.04

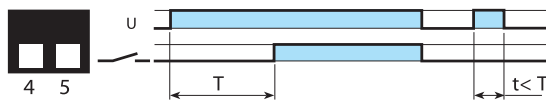

**(AI) On-delay.**

Apply power to timer.  
Output contacts transfer after preset time has elapsed.  
Reset occurs when power is removed.

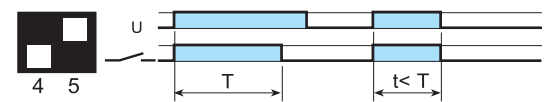

**(DI) Interval.**

Apply power to timer.  
Output contacts transfer immediately.  
After the preset time has elapsed, contacts reset.



**(GI) Pulse delayed.**

Apply power to timer. Output contacts transfer after preset time has elapsed. Reset occurs after a fixed time of 0.5 s.

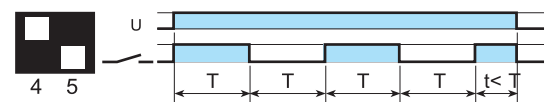

**(SW) Symmetrical flasher (starting pulse on).**

Apply power to timer.  
Output contacts transfer immediately and cycle between ON and OFF for as long as power is applied.  
The ratio is 1:1 (time on = time off).

- U** = Supply voltage
- S** = Signal switch
- U<sub>c</sub>** = Supply voltage to the timer
- 11-14** = Self-holding contact
- = Output contact

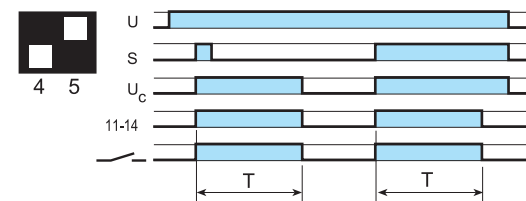

**Signal ON Pulse**

On momentary closure of Signal Switch (S) > 50 ms, the output contacts transfer and remain so (with self-holding on contact 11-14) for the duration of the preset delay, after which they reset.

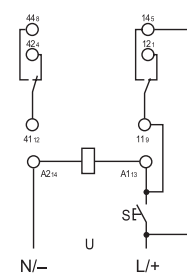

85.02

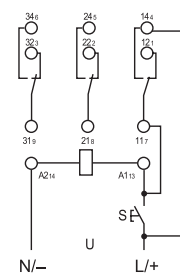

85.03

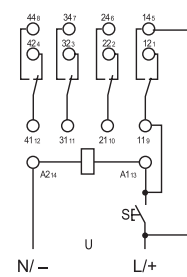

85.04

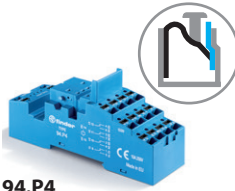

94.P4

Approvals  
(according to type):

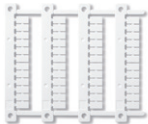

060.48

<b>Push-in terminal socket</b> panel or 35 mm (EN 60715) rail mount	<b>94.P3 Blue</b>	<b>94.P4 Blue</b>
For timer type	85.03	85.02, 85.04
<b>Accessories</b>		
Metal retaining clip		094.81
6-way jumper link		094.56
Identification tag		094.00.4
2-way jumper link		094.52.1
2-way jumper link		097.52
Marker tag holder		097.00
Sheet of marker tags for marker tag holder 097.00, 48 tags, 6 x 12 mm for CEMBRE thermal transfer printers		060.48
<b>Technical data</b>		
Rated values	10 A - 250 V	
Dielectric strength	2 kV AC	
Protection category	IP 20	
Ambient temperature	°C -40...+70	
Wire strip length	mm	8
Min. wire size for 94.P3 and 94.P4 sockets	solid wire	stranded wire
	mm <sup>2</sup>	0.5
	AWG	21
Max. wire size for 94.P3 and 94.P4 sockets	solid wire	stranded wire
	mm <sup>2</sup>	2 x 1.5 / 1 x 2.5
	AWG	2 x 18 / 1 x 14

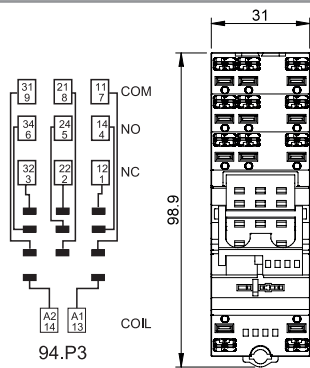

94.P3

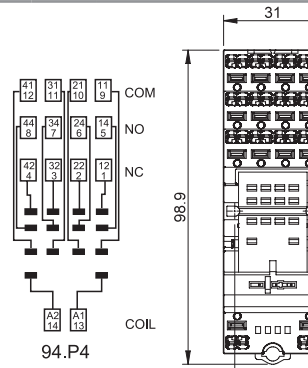

94.P4

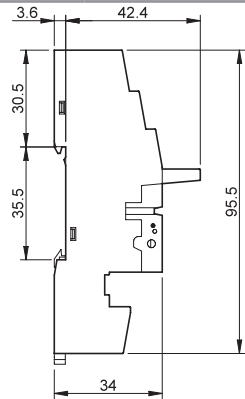

<b>6-way jumper link</b> for 94.P3 and 94.P4 sockets	094.56 (blue)
Rated values	10 A - 250 V

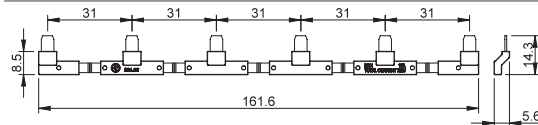

094.56

<b>2-way jumper link</b> for 94.P3 and 94.P4 sockets	094.52.1
Rated values	10 A - 250 V

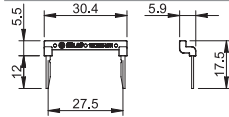

094.52.1

<b>2-way jumper link</b> for 94.P3 and 94.P4 sockets	097.52
Rated values	10 A - 250 V

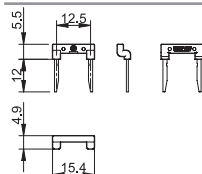

097.52

<b>Marker tag holder</b> for 94.P3 and 94.P4 sockets	097.00
--	--------

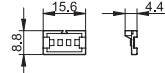

097.00



94.04

Approvals  
(according to type):

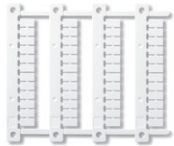

060.48

Screw terminal (Box clamp) socket panel or 35 mm (EN 60715) rail mount	94.02 Blue	94.02.0 Black	94.03 Blue	94.03.0 Black	94.04 Blue	94.04.0 Black
For timer type	85.02		85.03		85.04	
<b>Accessories</b>						
Metal retaining clip	094.81					
6-way jumper link	094.06	094.06.0	094.06	094.06.0	094.06	094.06.0
Identification tag	094.00.4					
Marker tag holder	097.00					
Sheet of marker tags marker tag holder 097.00, 48 tags, 6 x 12 mm for CEMBRE thermal transfer printers	060.48					
<b>Technical data</b>						
Rated values	10 A - 250 V					
Dielectric strength	2 kV AC					
Protection category	IP 20					
Ambient temperature	°C -40...+70					
Screw torque	Nm 0.5					
Wire strip length	mm 8					
Max. wire size for 94.02/03/04 sockets	solid wire			stranded wire		
	mm <sup>2</sup> 1 x 6 / 2 x 2.5			1 x 4 / 2 x 2.5		
	AWG 1 x 10 / 2 x 14			1 x 12 / 2 x 14		

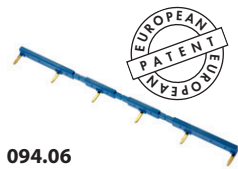
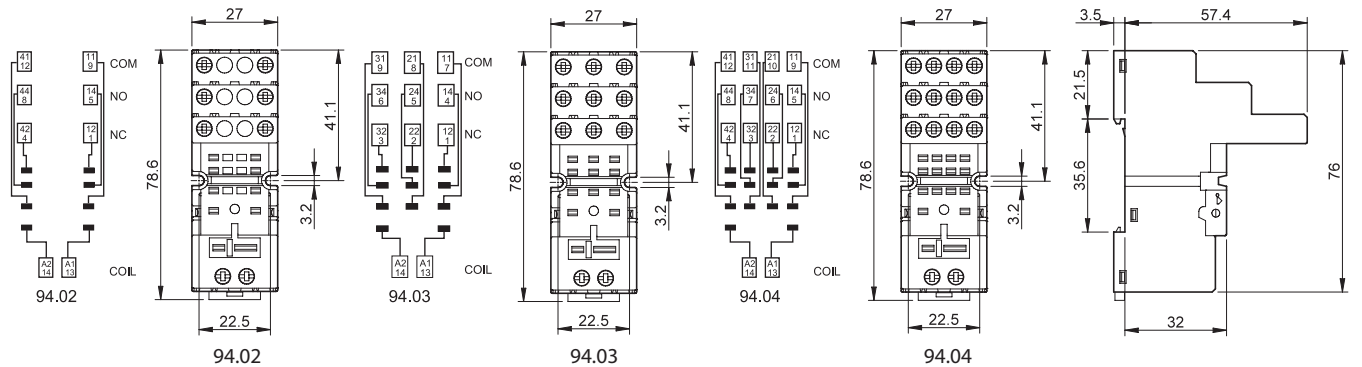

094.06

6-way jumper link for 94.02, 94.03 and 94.04 sockets	094.06 (blue)	094.06.0 (black)
Rated values	10 A - 250 V	

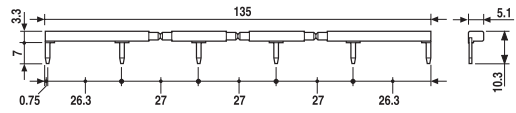



94.84.2

Approvals  
(according to type):



<b>Screw terminal (Box clamp) socket panel or 35 mm (EN 60715) rail mount</b>	<b>94.84.2</b>	<b>94.84.20</b>
For timer type	Blue	Black
	85.02, 85.04	
<b>Accessories</b>		
Metal retaining clip (supplied with socket - packaging code SMA)		094.81
6-way jumper link	094.06	094.06.0
Identification tag		094.80.3
<b>Technical data</b>		
Rated values	10 A - 250 V	
Dielectric strength	2 kV AC	
Protection category	IP 20	
Ambient temperature	°C -40...+70	
Screw torque	Nm	0.5
Wire strip length	mm	7
Max. wire size for 94.84.2 socket		
	mm <sup>2</sup>	solid wire      stranded wire
	AWG	1 x 6 / 2 x 2.5      1 x 4 / 2 x 2.5
	1 x 10 / 2 x 14	1 x 12 / 2 x 14

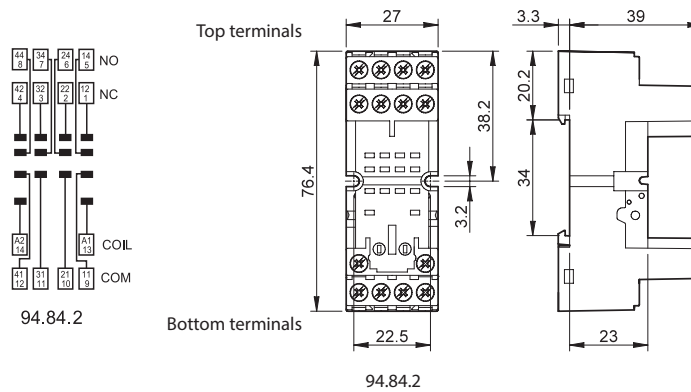

094.06



<b>6-way jumper link for 94.84.2 socket</b>	094.06 (blue)	094.06.0 (black)
Rated values	10 A - 250 V	

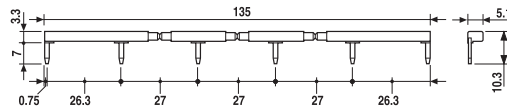



94.94.3

Approvals  
(according to type):



<b>Screw terminal (Box clamp) socket</b> panel or 35 mm rail mount	<b>94.92.3 (blue)</b>	<b>94.92.30 (black)</b>	<b>94.94.3 (blue)</b>	<b>94.94.30 (black)</b>
For timer type	85.02		85.04	
<b>Accessories</b>				
Metal retaining clip			094.81	
6-way jumper link	094.06	094.06.0	094.06	094.06.0
Identification tag			094.80.3	
<b>Technical data</b>				
Rated values	10 A - 250 V			
Dielectric strength	2 kV AC			
Protection category	IP 20			
Ambient temperature	°C	-25...+70		
Screw torque	Nm	0.5		
Wire strip length	mm	8		
Max. wire size for 94.92.3 and 94.94.3 sockets		solid wire		stranded wire
	mm <sup>2</sup>	1 x 6 / 2 x 2.5		1 x 4 / 2 x 2.5
	AWG	1 x 10 / 2 x 14		1 x 12 / 2 x 14

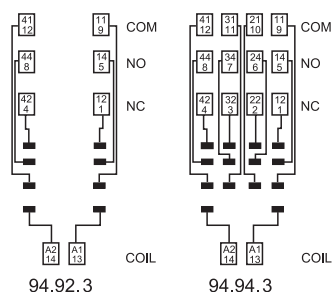



94.74

Approvals  
(according to type):



<b>Screw terminal (Plate clamp) socket</b> panel or 35 mm rail (EN 60715) mount	<b>94.72</b> <b>Blue</b>	<b>94.72.0</b> <b>Black</b>	<b>94.73</b> <b>Blue</b>	<b>94.73.0</b> <b>Black</b>	<b>94.74</b> <b>Blue</b>	<b>94.74.0</b> <b>Black</b>
For timer type	85.02		85.03		85.02, 85.04	

<b>Accessories</b>	
Metal retaining clip (supplied with timer)	094.81

<b>Screw terminal socket</b> panel or 35 mm rail (EN 60715) mount	<b>94.82</b> <b>Blue</b>	<b>94.82.0</b> <b>Black</b>
For timer type	85.02	

<b>Accessories</b>	
Metal retaining clip (supplied with timer)	094.81

**Technical data**

Rated values	10 A - 250 V	
Dielectric strength	2 kV AC	
Protection category	IP 20	
Ambient temperature	°C -40...+70	
Screw torque	Nm	0.5
Wire strip length	mm 8 (94.72, 94.73, 94.74)	9 (94.82)
Max. wire size for 94.72, 94.73, 94.74 and 94.82 sockets	solid wire	
	mm <sup>2</sup>	1 x 2.5 / 2 x 1.5
	AWG	1 x 14 / 2 x 16



94.82

Approvals  
(according to type):

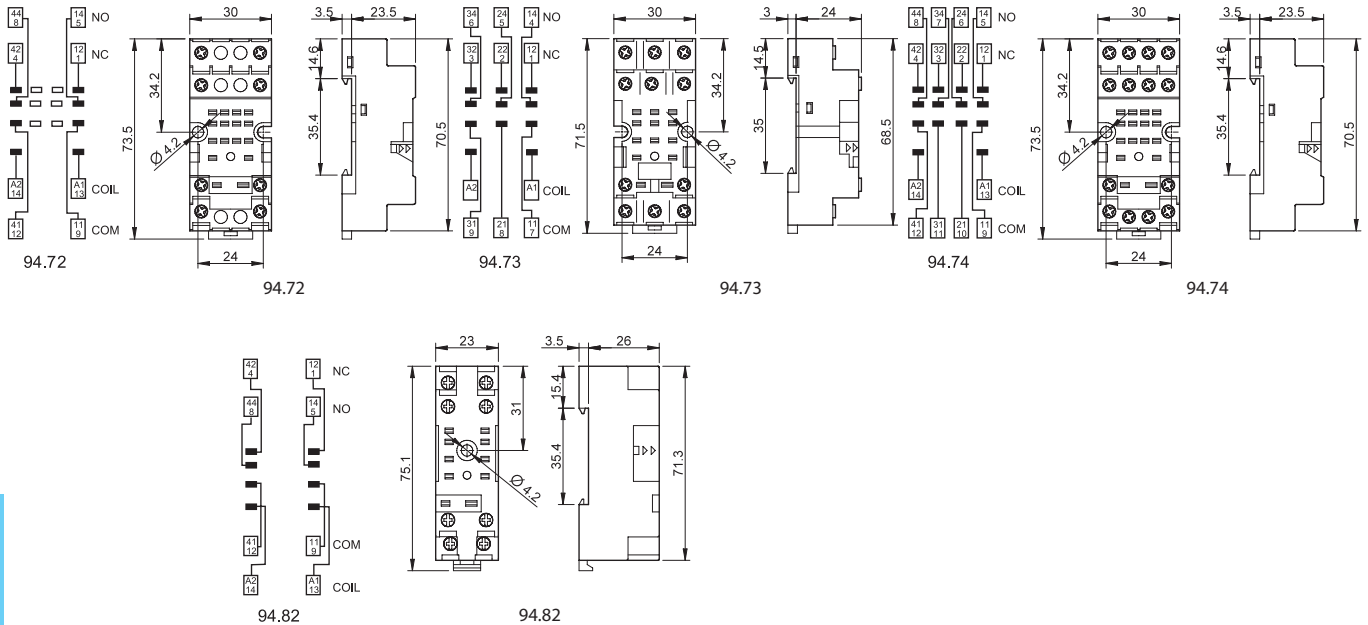



# Timer modules



Machines for ceramics



Machines for paper processing



Printing machines



Packaging machines



Wood-processing machines



Milk processing plant



Textile machines



86  
SERIES



Timer modules for use in conjunction with relay & socket.

**86.00 - Multi-function & multi-voltage timer module**

**86.30 - Bi-function & multi-voltage timer module**

- Timer module type 86.00 for 90, 92, 96 series sockets and type 86.30 for 90, 92, 94, 95, 96, 97 series sockets
- Wide supply voltage range:  
12...240 V AC/DC (86.00)  
12...24 V AC/DC or 230...240 V AC (86.30)
- LED indicator
- Atex versions available

**86.00**



- Time scale: from 0.05 s to 100 h
- Multi-function
- Plug-in for use with 90.02, 90.03, 92.03 and 96.04 sockets

**86.30**



- Time scale: from 0.05 s to 100 h
- Bi-function
- Plug-in for use with 90.02, 90.03, 92.03, 94.P3, 94.P4, 94.02, 94.03, 94.04, 95.P3, 95.P5, 95.03, 95.05, 96.02, 96.04, 97.P1, 97.P2, 97.01 and 97.02 sockets

- AI:** On-delay  
**DI:** Interval  
**SW:** Symmetrical flasher (starting pulse on)  
**BE:** Off-delay with control signal  
**CE:** On- and off-delay with control signal  
**DE:** Interval with control signal on  
**EE:** Interval with control signal off  
**FE:** Interval with control signal on and off

- AI:** On-delay  
**DI:** Interval

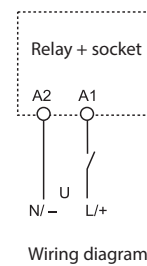
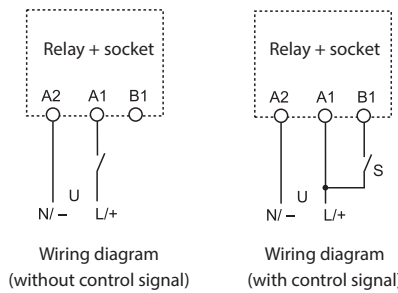

\* For Atex versions, refer to the "Other data" table on the page 4  
 For outline drawing see page 5

**Contact specification\***

Contact configuration	
Rated current/Maximum peak current	A
Rated voltage/Maximum switching voltage	V AC
Rated load AC1	VA
Rated load AC15 (230 V AC)	VA
Single phase motor rating (230 V AC)	kW
Breaking capacity DC1: 24/110/220 V	A
Minimum switching load	mW (V/mA)
Standard contact material	

See 56, 60 and 62 series relays  
 Note: Do not use with relays 62.3x.x012.x300 and 62.3x.x012.x600

See 40, 46, 55, 56, 60 and 62 series relays

**Supply specification\***

Nominal voltage (U <sub>N</sub> )	V AC (50/60 Hz)
	V DC
Rated power AC/DC	W
Operating range	V AC (50/60 Hz)
	DC

12...240	12...24	110...125	230...240
12...240	12...24	—	—
1.2	0.15		
10.2...265	9.6...33.6	88...137	184...265
10.2...265	9.6...33.6	—	—

**Technical data**

Specified time range	(0.05...1)s, (0.5...10)s, (5...100)s, (0.5...10)min, (5...100)min, (0.5...10)h, (5...100)h		
Repeatability	%	± 1	± 1
Recovery time	ms	≤ 50	≤ 50
Minimum control impulse	ms	50	—
Setting accuracy full range	%	± 5	± 5
Electrical life at rated load in AC1	cycles	See 56, 60 and 62 series relays	See 40, 46, 55, 56, 60 and 62 series relays
Ambient temperature range	°C	-20...+50	-20...+50
Protection category		IP 20	IP 20

**Approvals** (according to type)

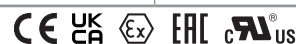

## Ordering information

Example: 86 series multi-function timer module, (12...240)V AC/DC supply voltage.

8 6 . 0 0 . 0 . 2 4 0 . 0 0 0 0

**Series**
**Type**

0 = Multi-function (AI, DI, SW, BE, CE, DE, EE, FE)

3 = Bi-function (AI, DI)

**No. of poles**

See 40, 46, 55, 56, 60 and 62 series relays

Poles for chosen relay/socket combination - according to chart below

**Supply voltage**

024 = (12...24)V AC/DC (86.30 only)

120 = (110...125)V AC (86.30 only)

240 = (12...240)V AC/DC (86.00 only)

240 = (12...48)V AC/DC

(86.00.0.240.0073 only)

240 = (230...240)V AC (86.30 only)

**Supply version**

0 = AC (50/60 Hz)/DC

8 = AC (50/60 Hz)

## Combinations

Number of poles	Relay type	Socket type	Timer module
1	40.31	95.P3/95.03	86.30
1	40.51/61	95.P5/95.05	86.30
1	46.61	97.P1/97.01	86.30
2	40.52/40.62	95.P5/95.05	86.30
2	46.52	97.P2/97.02	86.30
2	55.32	94.P4/94.02	86.30
2	56.32	96.02	86.30
2	60.12	90.02	86.00/86.30
2	62.32	92.03	86.00/86.30
3	55.33	94.P3/94.03	86.30
3	60.13	90.03	86.00/86.30
3	62.33	92.03	86.00/86.30
4	55.34	94.P4/94.04	86.30
4	56.34	96.04	86.00/86.30

## Other data Timer ATEX versions

Code available	Nominal voltage	Operating range	Use temperature
86.00.0.240.0073	12-48 V AC/DC	10.2...60 V AC/DC	-20...+50°C
86.30.0.024.0073	12-24 V AC/DC	9.6...33.6 V AC/DC	-20...+50°C

## Markings - ATEX versions - ATEX, II 3G Ex ec IIC Gc

MARKING	
	Specific marking of explosion protection
II	Component for surface plant (different from mines)
3	Category 3: normal level of protection
GAS	<b>G</b> Explosive atmosphere due to presence of combustible gas vapour or mist
	<b>Ex ec</b> Increased security
	<b>IIC</b> Gas group
	<b>Gc</b> Equipment Protection Level
-20 °C ≤ Ta ≤ +50 °C Ambient temperature	
<b>EPTI 17 ATEX 0264 U</b> EPTI: laboratory which issues the CE type certificate 17: year of issue of certificate 0264: number of CE type certificate	
<b>U: ATEX component</b>	

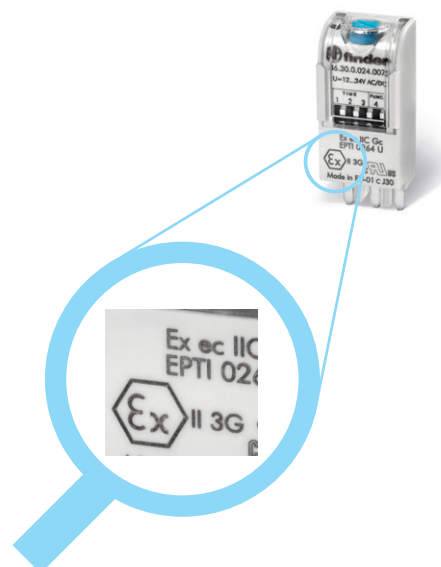

## Technical data

EMC specifications				
Type of test		Reference standard	86.00	86.30
Electrostatic discharge	contact discharge	EN 61000-4-2	4 kV	n.a.
	air discharge	EN 61000-4-2	8 kV	8 kV
Radio-frequency electromagnetic field (80 ÷ 1000 MHz)		EN 61000-4-3	10 V/m	10 V/m
Fast transients (burst) (5-50 ns, 5 kHz) on Supply terminals		EN 61000-4-4	4 kV	2 kV
Surges (1.2/50 µs) on Supply terminals	common mode	EN 61000-4-5	4 kV	2 kV
	differential mode	EN 61000-4-5	4 kV	1 kV
Radio-frequency common mode (0.15 ÷ 80 MHz) on Supply terminals		EN 61000-4-6	10 V	10 V
Radiated and conducted emission		EN55022	class B	class B
Other data		86.00	86.30	
Current absorption on signal control (B1)		mA	1	—
Power lost to the environment	without contact current	W	0.1 (12 V) - 1 (230 V)	0.2
	with rated current		See 56, 60 and 62 series relays	See 40, 46, 55, 56, 60, 62 series relays

## Times scales

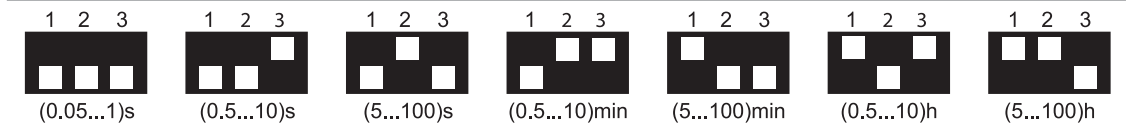

NOTE: Time scales and functions must be set before energising the timer.

To achieve the minimum time setting of 0.05 seconds it is necessary to use one of the functions with control signal. When setting very short times it may be necessary to take into account the operate time of the relay used.

## Outline drawings

Type 86.00

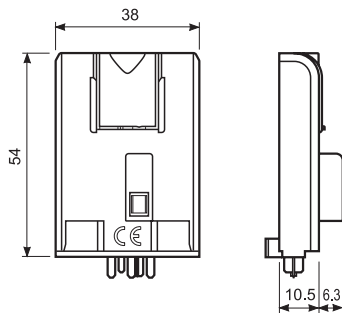

Type 86.30

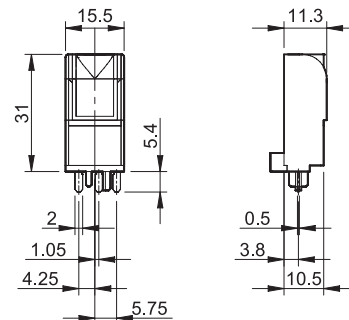

Functions

U = Supply voltage

S = Signal switch

— = Output contact

LED Type 86.00	LED Type 86.30	Supply voltage	NO output contact
		OFF	Open
		ON	Open
		ON	Open (Timing in Progress)
		ON	Closed

Without control signal = Start via contact in supply line (A1).  
With control signal = Start via contact into control terminal (B1).

Wiring diagram

Without control signal

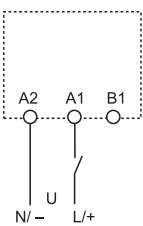

Type 86.00

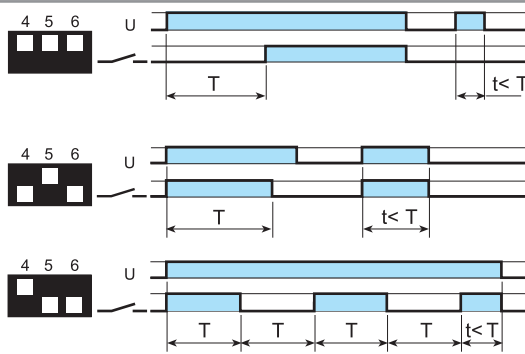

(AI) On-delay.

Apply power to timer. Output contacts transfer after preset time has elapsed. Reset occurs when power is removed.

(DI) Interval.

Apply power to timer. Output contacts transfer immediately. After the preset time has elapsed, contacts reset.

(SW) Symmetrical flasher (starting pulse on).

Apply power to timer. Output contacts transfer immediately and cycle between ON and OFF for as long as power is applied. The ratio is 1:1 (time on = time off).

With control signal

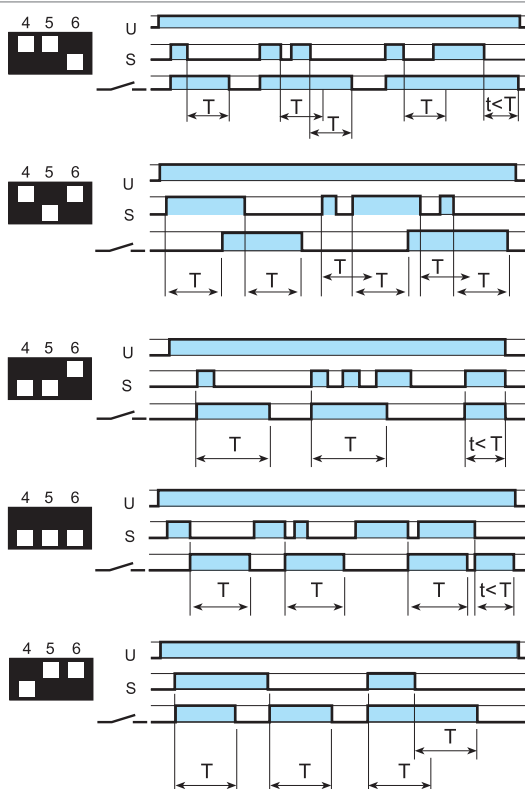
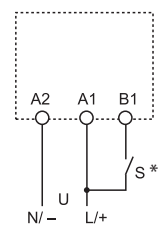

(BE) Off-delay with control signal.

Power is permanently applied to the timer. The output contacts transfer immediately on closure of the Signal Switch (S). Opening the Signal Switch initiates the preset delay, after which time the output contacts reset.

(CE) On- and off-delay with control signal.

Power is permanently applied to the timer. Closing the Signal Switch (S) initiates the preset delay, after which time the output contacts transfer. Opening the Signal switch initiates the same preset delay, after which time the output contacts reset.

(DE) Interval with control signal on.

Power is permanently applied to the timer. On momentary or maintained closure of Signal Switch (S), the output contacts transfer, and remain so for the duration of the preset delay, after which they reset.

(EE) Interval with control signal off.

Power is permanently applied to the timer. On opening of the Signal Switch (S) the output contacts transfer, and remain so for the duration of the preset delay, after which they reset.

(FE) Interval with control signal on and off.

Power is permanently applied to the timer. Both the opening and closing of the Signal Switch (S) initiates the transfer of the output contacts. In both instances the contacts reset after the delay period has elapsed.

\* With DC supply, positive polarity has to be connected to B1 terminal (according to EN 60204-1). Switch S should be exclusively used to provide the control signal to terminal B1. (Do not connect any other load at this point).

Wiring diagram

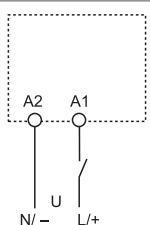

Type 86.30

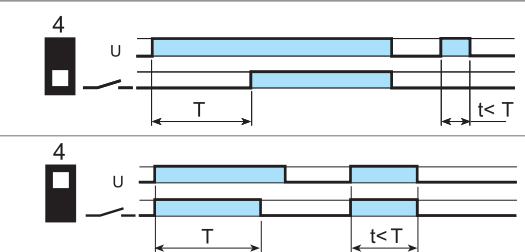

(AI) On-delay.

Apply power to timer. Output contacts transfer after preset time has elapsed. Reset occurs when power is removed.

(DI) Interval.

Apply power to timer. Output contacts transfer immediately. After the preset time has elapsed, contacts reset.



90.03

Approvals  
(according to type):



<b>Screw terminal (Box clamp) socket</b> panel or 35 mm rail (EN 60715) mount	<b>90.02</b> <b>Blue</b>	<b>90.02.0</b> <b>Black</b>	<b>90.03</b> <b>Blue</b>	<b>90.03.0</b> <b>Black</b>
For relay type	60.12		60.13	
<b>Accessories</b>				
Metal retaining clip	090.33			
6-way jumper link	090.06			
Identification tag	090.00.2			
Timer module	86.00, 86.30			
<b>Technical data</b>				
Double terminal A1 (for easy start connection)	—			
Rated values	10 A - 250 V			
Dielectric strength	2 kV AC			
Protection category	IP 20			
Ambient temperature	°C -40...+70			
Screw torque	Nm 0.6			
Wire strip length	mm 10			
Max. wire size for 90.02 and 90.03 sockets	solid wire		stranded wire	
	mm <sup>2</sup> 1 x 6 / 2 x 2.5		1 x 4 / 2 x 2.5	
	AWG 1 x 10 / 2 x 14		1 x 12 / 2 x 14	

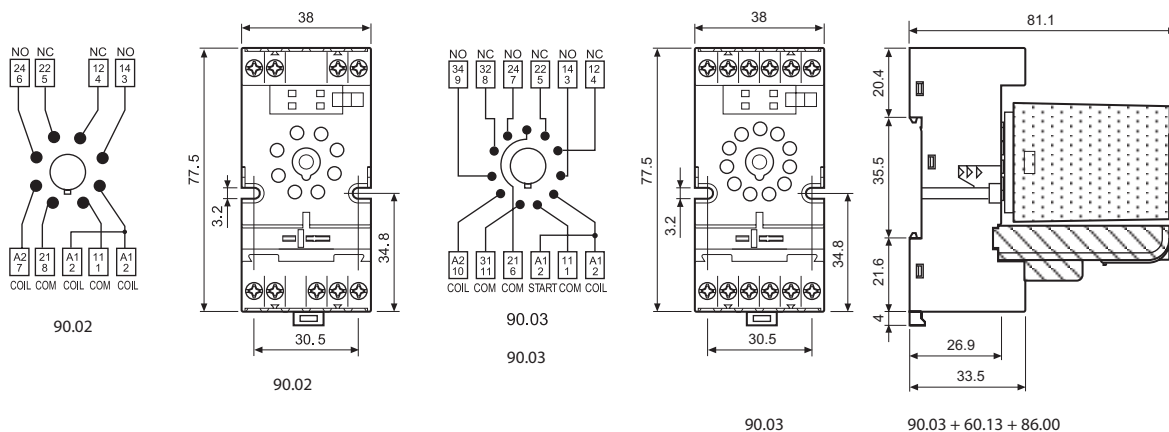

<b>6-way jumper link for 90.02 and 90.03 sockets</b>	<b>090.06</b>
Rated values	10 A - 250 V

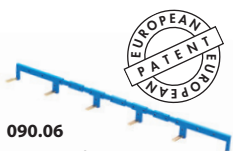

090.06

Approvals  
(according to type):

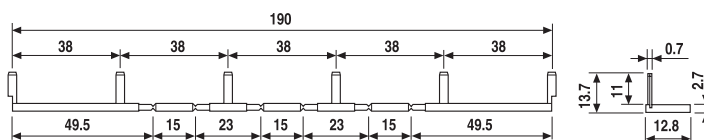



92.03  
Approvals  
(according to type):



<b>Screw terminal (Box clamp) socket</b> panel or 35 mm rail (EN 60715) mount	<b>92.03</b> <b>Blue</b>	<b>92.03.0</b> <b>Black</b>
For relay type	62.32, 62.33	
<b>Accessories</b>		
Metal retaining clip (supplied with socket - packaging code SMA)	092.71	
Identification tag	092.00.2	
Timer modules	86.00, 86.30	
<b>Technical data</b>		
Rated values	16 A - 250 V	
Dielectric strength	6 kV (1.2/50 μs) between coil and contacts	
Protection category	IP 20	
Ambient temperature	°C -40...+70 (see diagram L92)	
Screw torque	Nm	0.8
Wire strip length	mm 10	
Max. wire size for 92.03 socket	solid wire	stranded wire
	mm <sup>2</sup>	1 x 10 / 2 x 4
	AWG	1 x 8 / 2 x 12

L 92 - Rated current v ambient temperature

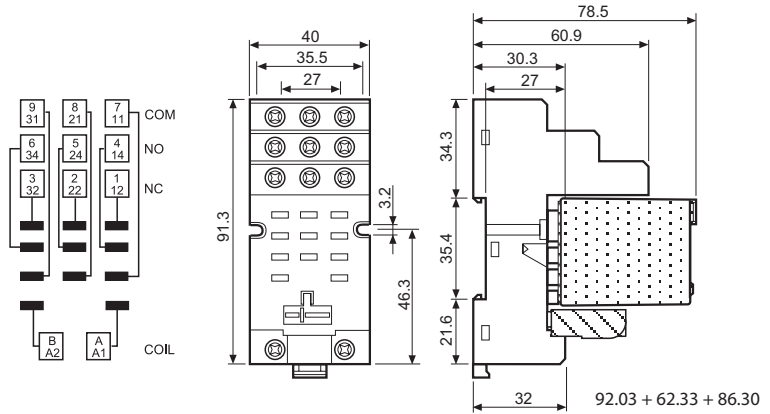
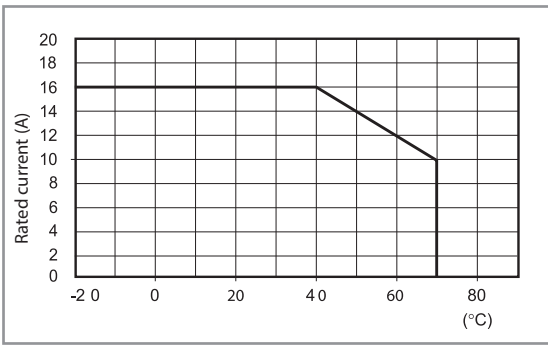



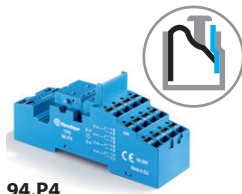

94.P4

Approvals  
(according to type):



Certain relay/socket combinations



094.91.3

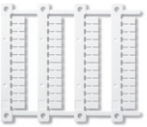

060.48

<b>Push-in terminal socket panel or 35 mm (EN 60715) rail mount</b>	<b>94.P3</b>	<b>94.P4</b>
For relay type	<b>Blue</b>	<b>Blue</b>
	55.33	55.32, 55.34
<b>Accessories</b>		
Metal retaining clip		094.71
Plastic retaining and release clip (supplied with socket - packaging code SPA)		094.91.3
6-way jumper link		094.56
Identification tag		094.00.4
2-way jumper link		094.52.1
2-way jumper link		097.52
Marker tag holder		097.00
Timer modules (see table below)		86.30
Sheet of marker tags for plastic retaining and release clip 094.91.3 and for marker tag holder 097.00, 48 tags, 6 x 12 mm for CEMBRE thermal transfer printers		060.48
<b>Technical data</b>		
Rated values	10 A - 250 V	
Dielectric strength	2 kV AC	
Protection category	IP 20	
Ambient temperature	°C -40...+70	
Wire strip length	mm 8	
Min. wire size for 94.P3 and 94.P4 sockets	solid wire	stranded wire
	mm <sup>2</sup> 0.5	0.5
Max. wire size for 94.P3 and 94.P4 sockets	AWG 21	21
	solid wire	stranded wire
mm <sup>2</sup>	2 x 1.5 / 1 x 2.5	2 x 1.5 / 1 x 2.5
AWG	2 x 18 / 1 x 14	2 x 18 / 1 x 14

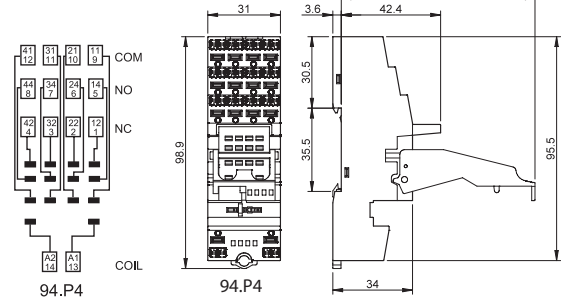
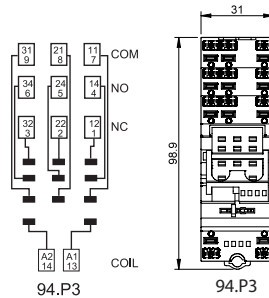

<b>6-way jumper link for 94.P3 and 94.P4 sockets</b>	094.56 (blue)
Rated values	10 A - 250 V

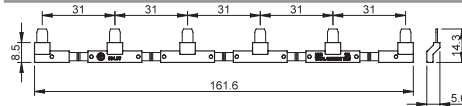

<b>2-way jumper link for 94.P3 and 94.P4 sockets</b>	094.52.1
Rated values	10 A - 250 V

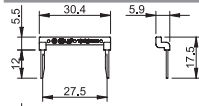

<b>2-way jumper link for 94.P3 and 94.P4 sockets</b>	097.52
Rated values	10 A - 250 V

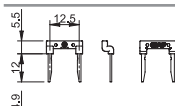

<b>Marker tag holder for 94.P3 and 94.P4 sockets</b>	097.00
--	--------

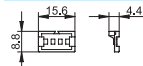

<b>86 series timer modules</b>	
(12...24)V AC/DC; Bi-function: AI, DI; (0.05 s...100 h)	86.30.0.024.0000
(110...125)V AC; Bi-function: AI, DI; (0.05 s...100 h)	86.30.8.120.0000
(230...240)V AC; Bi-function: AI, DI; (0.05 s...100 h)	86.30.8.240.0000

Approvals (according to type):

097.00



86.30



94.04

Approvals  
(according to type):



Certain relay/socket combinations



094.91.3

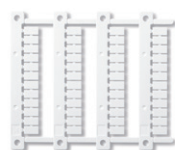

060.48

<b>Screw terminal (Box clamp) socket panel or 35 mm (EN 60715) rail mount</b>	<b>94.02</b>	<b>94.02.0</b>	<b>94.03</b>	<b>94.03.0</b>	<b>94.04</b>	<b>94.04.0</b>
	<b>Blue</b>	<b>Black</b>	<b>Blue</b>	<b>Black</b>	<b>Blue</b>	<b>Black</b>
For relay type	55.32		55.33		55.32, 55.34	
<b>Accessories</b>						
Metal retaining clip	094.71					
Plastic retaining and release clip (supplied with socket - packaging code SPA)	094.91.3	094.91.30	094.91.3	094.91.30	094.91.3	094.91.30
6-way jumper link	094.06	094.06.0	094.06	094.06.0	094.06	094.06.0
Identification tag	094.00.4					
Marker tag holder	097.00					
Timer modules (see table below)	86.30					
Sheet of marker tags for plastic retaining and release clip 094.91.3 and for marker tag holder 097.00, 48 tags, 6 x 12 mm for CEMBRE thermal transfer printers	060.48					
<b>Technical data</b>						
Rated values	10 A - 250 V					
Dielectric strength	2 kV AC					
Protection category	IP 20					
Ambient temperature	°C -40...+70					
Screw torque	Nm	0.5				
Wire strip length	mm	8				
Max. wire size for 94.02/03/04 sockets	mm <sup>2</sup>	solid wire		stranded wire		
		1 x 6 / 2 x 2.5		1 x 4 / 2 x 2.5		
	AWG	1 x 10 / 2 x 14		1 x 12 / 2 x 14		

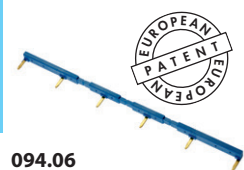
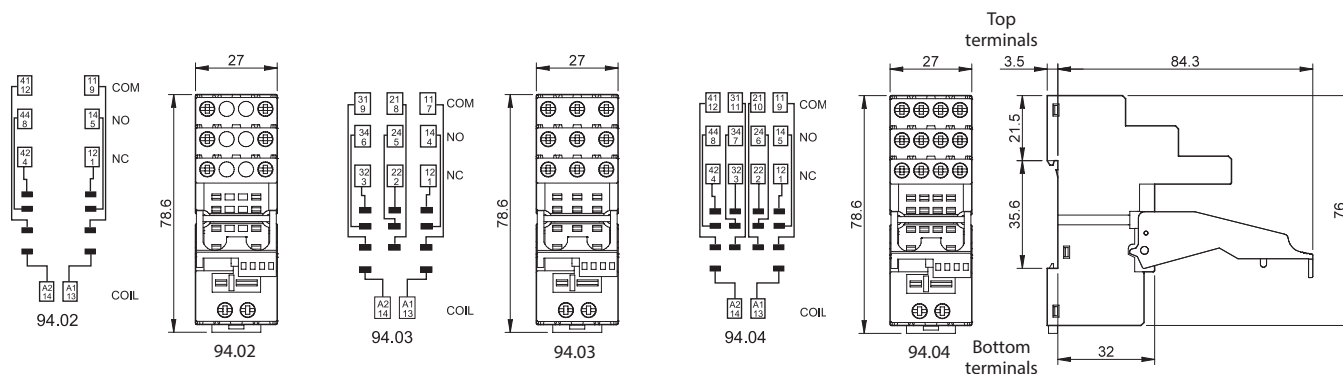

094.06

<b>6-way jumper link for 94.02, 94.03 and 94.04 sockets</b>	<b>094.06 (blue)</b>	<b>094.06.0 (black)</b>
Rated values	10 A - 250 V	

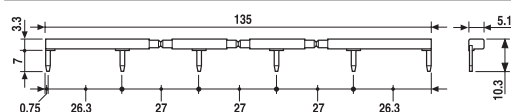

86.30

<b>86 series timer modules</b>		
(12...24)V AC/DC; Bi-function: AI, DI; (0.05 s...100 h)	86.30.0.024.0000	
(110...125)V AC; Bi-function: AI, DI; (0.05 s...100 h)	86.30.8.120.0000	
(230...240)V AC; Bi-function: AI, DI; (0.05 s...100 h)	86.30.8.240.0000	

Approvals (according to type):







**96.02**  
Approvals  
(according to type):



**96.04**  
Approvals  
(according to type):



**094.91.3**

Screw terminal (Box clamp) socket panel or 35 mm rail (EN 60715) mount	96.02 Blue	96.02.0 Black	96.04 Blue	96.04.0 Black
For relay type	56.32		56.34	
<b>Accessories</b>				
Metal retaining clip (supplied with socket - packaging code SMA)	094.71		096.71	
Plastic retaining and release clip (supplied with socket - packaging code SPA)	094.91.3	094.91.30	—	—
6-way jumper link	094.06	094.06.0	—	—
Identification tag	095.00.4		090.00.2	
Timer modules	86.30		86.00, 86.30	
<b>Technical data</b>				
Rated values	12 A - 250 V			
Dielectric strength	2 kV AC			
Protection category	IP 20			
Ambient temperature	°C -40...+70			
Screw torque	Nm	0.8		
Wire strip length	mm	8		
Max. wire size for 96.02/04 sockets		solid wire	stranded wire	
	mm <sup>2</sup>	1 x 6 / 2 x 2.5		1 x 4 / 2 x 2.5
	AWG	1 x 10 / 2 x 14		1 x 12 / 2 x 14

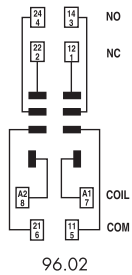

96.02

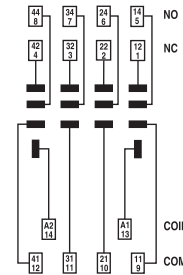

96.04

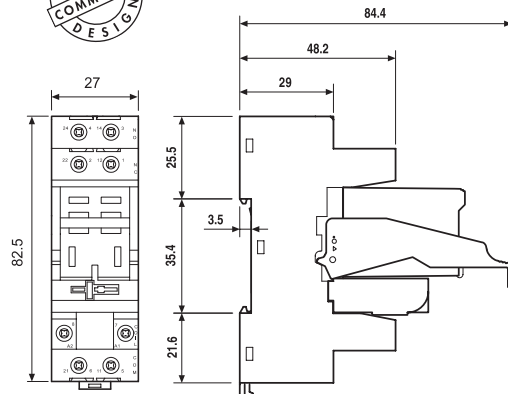

96.02

96.02 + 56.32 + 094.91.3 + 86.30

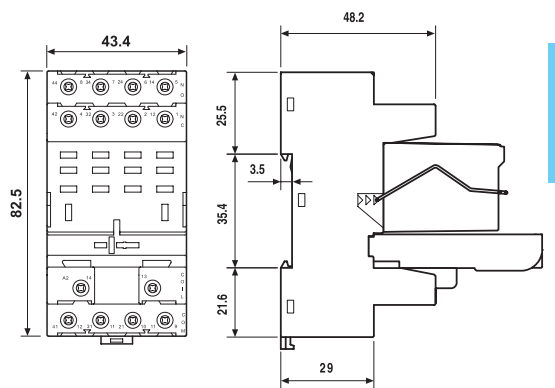

96.04

96.04 + 56.34 + 096.71 + 86.00

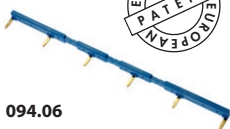

**094.06**



6-way jumper link for 96.02 socket	094.06 (blue)	094.06.0 (black)
Rated values	10 A - 250 V	

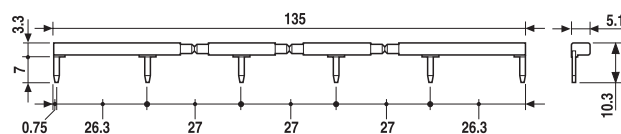



97.P2

Approvals  
(according to type):



097.01

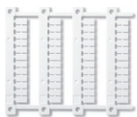

060.48

<b>Push-in terminal socket</b> panel or 35 mm rail (EN 60715) mount	<b>97.P1</b>	<b>97.P2</b>
For relay type	46.61	46.52
<b>Accessories</b>		
Plastic retaining and release clip (supplied with socket - packaging code SPA)		097.01
Metal retaining clip		097.71
Identification tag		095.00.4
8-way jumper link		097.58
2-way jumper link		097.52
2-way jumper link		097.42
Marker tag holder		097.00
Timer modules (see table below)		86.30
Sheet of marker tags for marker tag holder 097.00, 48 tags, 6 x 12 mm, for CEMBRE thermal transfer printers		060.48
<b>Technical data</b>		
Rated values	16 A-250 V AC	8 A-250 V AC
Dielectric strength	6 kV (1.2/50 μs) between coil and contacts	
Protection category	IP 20	
Ambient temperature	°C -40...+70 (see diagram L97)	
Wire strip length	mm 8	
Min. wire size for 97.P1 and 97.P2 socket	solid wire	stranded wire
	mm <sup>2</sup> 0.5	0.5
	AWG 21	21
Max. wire size for 97.P1 and 97.P2 socket	solid wire	stranded wire
	mm <sup>2</sup> 2 x 1.5 / 1 x 2.5	2 x 1.5 / 1 x 2.5
	AWG 2 x 18 / 1 x 14	2 x 18 / 1 x 14

L 97 - Rated current v ambient temperature

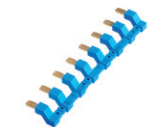
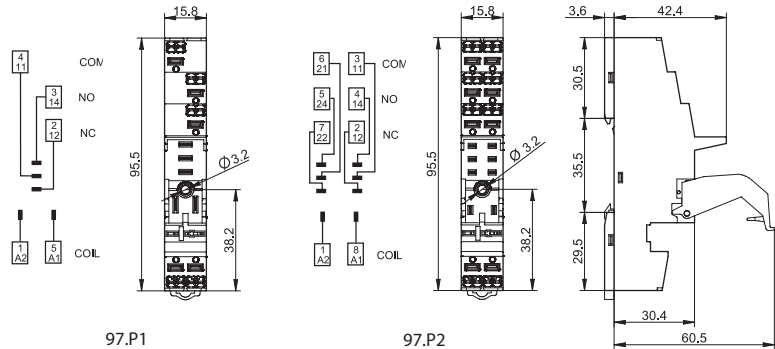
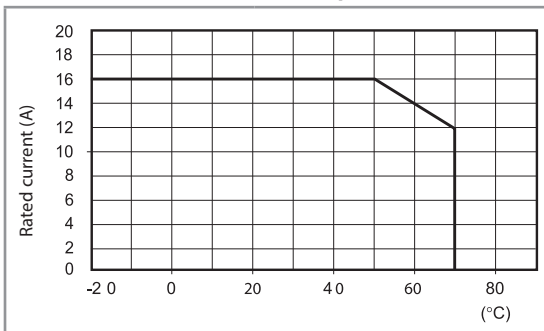

097.58

<b>8-way jumper link</b> for 97.P1 and 97.P2 sockets	097.58
Rated values	10 A - 250 V

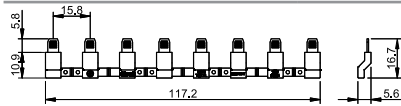

097.52

<b>2-way jumper link</b> for 97.P1 and 97.P2 sockets	097.52
Rated values	10 A - 250 V

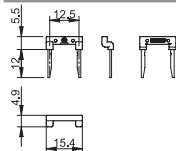

097.42

<b>2-way jumper link</b> for 97.P1 and 97.P2 sockets	097.42
Rated values	10 A - 250 V

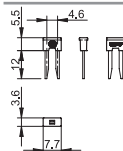

097.00

<b>Marker tag holder</b> for 95.P3 and 95.P5 sockets	097.00
--	--------

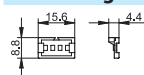

86.30

<b>86 series timer modules</b>	
(12...24)V AC/DC; Bi-function: AI, DI; (0.05 s...100 h)	86.30.0.024.0000
(110...125)V AC; Bi-function: AI, DI; (0.05 s...100 h)	86.30.8.120.0000
(230...240)V AC; Bi-function: AI, DI; (0.05 s...100 h)	86.30.8.240.0000

Approvals (according to type):

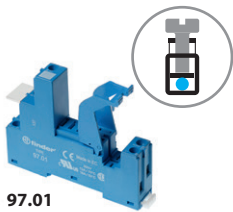

97.01

Approvals  
(according to type):



097.01

<b>Screw terminal socket</b>	<b>97.01</b>	<b>97.02</b>	
panel or 35 mm rail (EN 60715) mount	<b>Blue</b>	<b>Blue</b>	
For relay type	46.61	46.52	
<b>Accessories</b>			
Plastic retain and eject clip (supplied with socket - packaging code SPA)	097.01		
8-way jumper link	095.18 (blue)	095.18.0 (black)	
Identification tag	095.00.4		
Timer modules	86.30		
<b>Technical data</b>			
Rated current	16 A - 250 V AC	8 A - 250 V AC	
Dielectric strength	6 kV (1.2/50 μs) between coil and contacts		
Protection category	IP 20		
Ambient temperature	°C -40...+70 (see diagram L97)		
Screw torque	Nm	0.8	
Wire strip length	mm	8	
Max. wire size for 97.01 and 97.02 sockets	solid wire	stranded wire	
	mm <sup>2</sup>	1 x 6 / 2 x 2.5	1 x 4 / 2 x 2.5
	AWG	1 x 10 / 2 x 14	1 x 12 / 2 x 14

**L 97 - Rated current v ambient temperature**  
(for 46.61 relay / 97.01 socket combination)

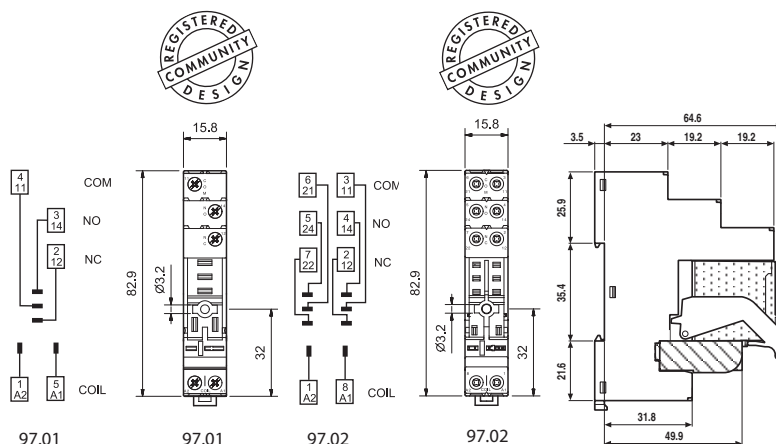
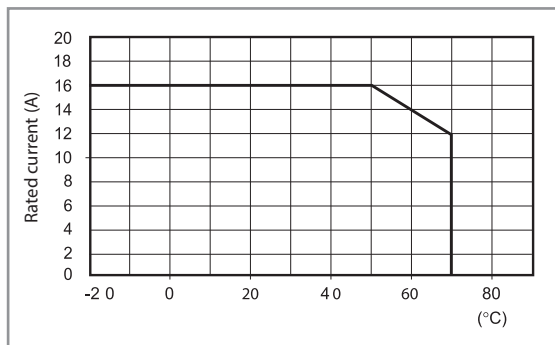

97.02 + 46.52 + 097.01  
+ 86.30



095.18

<b>8-way jumper link for 97.01 and 97.02 sockets</b>	095.18 (blue)	095.18.0 (black)
Rated values	10 A - 250 V	

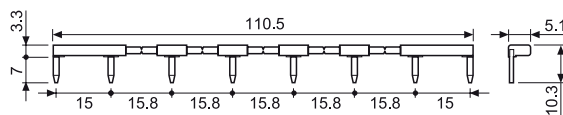





# Plug-in timers 8 A



Drying kilns



Industrial furnaces and ovens



Industrial washing machines



Hoists and cranes



Wood-processing machines



Medical and dentistry



88  
SERIES



**Multi-voltage and multi-function timer range  
Front panel or socket mount**

- 8 and 11 pin plug-in versions available
- Time scales from 0.05 s to 100 h
- "1 delayed contact + 1 instantaneous contact" version available (type 88.12)
- Front panel mounting fixing included
- 90 series sockets

**88.02**



- Multi-function
- 11 pin
- Plug-in for use with 90 series sockets

**88.12**



- Multi-function
- 8 pin, 2 timed contacts or 1 timed + 1 instantaneous contact
- Plug-in for use with 90 series sockets

**AI:** On-delay

**DI:** Interval

**GI:** Pulse delayed

**SP:** Symmetrical flasher (starting pulse off) without control signal

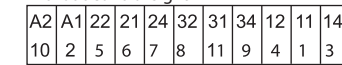

**BE:** Off-delay with control signal

**CEa:** On- and off-delay with control signal

**DE:** Interval with control signal on with control signal

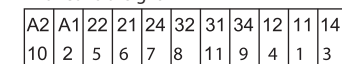

P = Pause  
S = Start  
R = Reset

**AI a:** On-delay (2 timed contacts)

**AI b:** On-delay (1 timed + 1 instantaneous contact)

**DI a:** Interval (2 timed contacts)

**DI b:** Interval (1 timed + 1 instantaneous contact)

**GI:** Pulse delayed

**SW:** Symmetrical flasher (starting pulse on)

without control signal

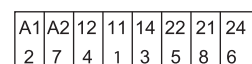

U~

For outline drawing see page 5

**Contact specification**

Contact configuration		2 CO (DPDT)	2 CO (DPDT)
Rated current/Maximum peak current	A	8/15	8/15
Rated voltage/ Maximum switching voltage	V AC	250/400	250/400
Rated load AC1	VA	2000	2000
Rated load AC15 (230 V AC)	VA	400	400
Single phase motor rating (230 V AC)	kW	0.3	0.3
Breaking capacity DC1: 24/110/220 V	A	8/0.3/0.12	8/0.3/0.12
Minimum switching load	mW (V/mA)	300 (5/5)	300 (5/5)
Standard contact material		AgNi	AgNi

**Supply specification**

Nominal voltage (U <sub>n</sub> )	V AC (50/60 Hz)	24...230	24...230
	V DC	24...230	24...230
Rated power AC/DC	VA (50 Hz)/W	2.5 (230 V)/1 (24 V)	2.5 (230 V)/1.5 (24 V)
Operating range	V AC	20.4...264.5	20.4...264.5
	V DC	20.4...264.5	20.4...264.5

**Technical data**

Specified time range		(0.05 s...5 h) - (0.05 s...10 h) - (0.05 s...50 h) - (0.05 s...100 h)
Repeatability	%	± 1
Recovery time	ms	300
Minimum control impulse	ms	50
Setting accuracy-full range	%	± 3
Electrical life at rated load AC1	cycles	100 · 10 <sup>3</sup>
Ambient temperature range	°C	-10...+55
Protection category		IP 40

**Approvals** (according to type)



**Multi-voltage and mono-function timer range**  
**Front panel or socket mount**

- Asymmetrical flasher The ON and OFF time are independently adjustable
- 8 pin plug-in
- Time scales from 0.05 s to 300 h
- 2 contacts
- Front panel mounting fixing included
- 90 series sockets

**88.92 - 0000**



- Mono-function
- 8 pin, 2 timed contacts
- Plug-in for use with 90 series sockets

**PI:** Asymmetrical flasher (starting pulse OFF)

without control signal

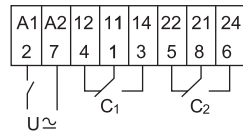

**88.92 - 0001**



- Mono-function
- 8 pin, 2 timed contacts
- Plug-in for use with 90 series sockets

**LI:** Asymmetrical flasher (starting pulse ON)

without control signal

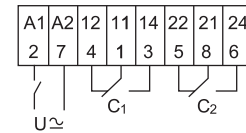

For outline drawing see page 5

**Contact specification**

Contact configuration		2 CO (DPDT)	2 CO (DPDT)
Rated current/Maximum peak current	A	8/15	8/15
Rated voltage/ Maximum switching voltage	V AC	250/400	250/400
Rated load AC1	VA	2000	2000
Rated load AC15 (230 V AC)	VA	400	400
Single phase motor rating (230 V AC)	kW	0.3	0.3
Breaking capacity DC1: 24/110/220 V	A	8/0.3/0.12	8/0.3/0.12
Minimum switching load	mW (V/mA)	300 (5/5)	300 (5/5)
Standard contact material		AgNi	AgNi

**Supply specification**

Nominal voltage (U <sub>N</sub> )	V AC (50/60 Hz)	12...240	12...240
	V DC	12...240	12...240
Rated power AC/DC	VA (50 Hz)/W	2.5 (230 V)/1.5 (24 V)	2.5 (230 V)/1.5 (24 V)
Operating range	V AC	10.8...264.5	10.8...264.5
	V DC	10.8...264.5	10.8...264.5

**Technical data**

Specified time range		See "Time Scale" page 6	See "Time Scale" page 6
Repeatability	%	± 1	± 1
Recovery time	ms	200	200
Minimum control impulse	ms	—	—
Setting accuracy-full range	%	± 1	± 1
Electrical life at rated load AC1	cycles	100 · 10 <sup>3</sup>	100 · 10 <sup>3</sup>
Ambient temperature range	°C	-10...+55	-10...+55
Protection category		IP 40	IP 40

**Approvals** (according to type)



### Ordering information

Example: 88 series multi-function timer, 2 CO (DPDT) 8 A contacts, (24...230)V AC (50/60 Hz) and (24...230)V DC supply.



**Series**

**Type**

- 0 = Functions AI, DI, GI, SP, BE, CEa, DE, 11 pin
- 1 = Functions AI a, AI b, DI a, DI b, GI, SW, 8 pin
- 9 = Functions LI, PI, 8 pin

**No. of poles**

2 = 2 pole

**Supply version**

0 = AC (50/60 Hz)/DC

**Special versions**

- 0 = Functions PI (starting pulse OFF) for 88.92
- 1 = Functions LI (starting pulse ON) for 88.92
- 2 = Standard

**Supply voltage**

- 230 = (24...230)V AC/DC for 88.02, 88.12
- 240 = (12...240)V AC/DC for 88.92

**Codes**

- 88.02.0.230.0002
- 88.12.0.230.0002
- 88.92.0.240.0000
- 88.92.0.240.0001

### Technical data

#### EMC specifications

Type of test	Reference standard	88.02/88.12	88.92
Electrostatic discharge	contact discharge	EN 61000-4-2	4 kV
	air discharge	EN 61000-4-2	8 kV
Radio-frequency electromagnetic field (80 ÷ 1000 MHz)	EN 61000-4-3	10 V/m	10 V/m
Fast transients (burst) (5-50 ns, 5 kHz) on Supply terminals	EN 61000-4-4	2 kV	—
Surges (1.2/50 µs) on Supply terminals	common mode	EN 61000-4-5	2 kV
	differential mode	EN 61000-4-5	1 kV
Radio-frequency common mode (0.15 ÷ 80 MHz) on Supply terminals	EN 61000-4-6	3 V	—

#### Other data

Power lost to the environment	without contact current W	3.4
	with rated current W	4.7

### Outline drawings

Types 88.02/12

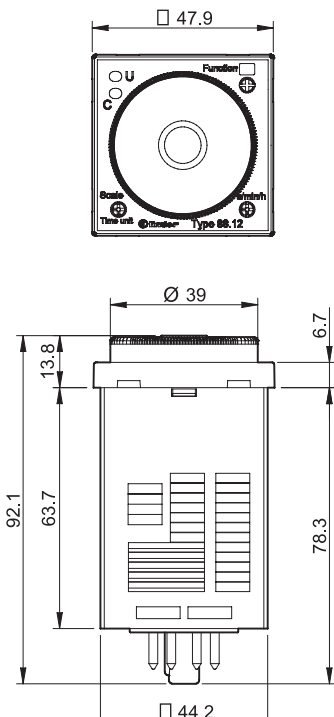

Type 88.92

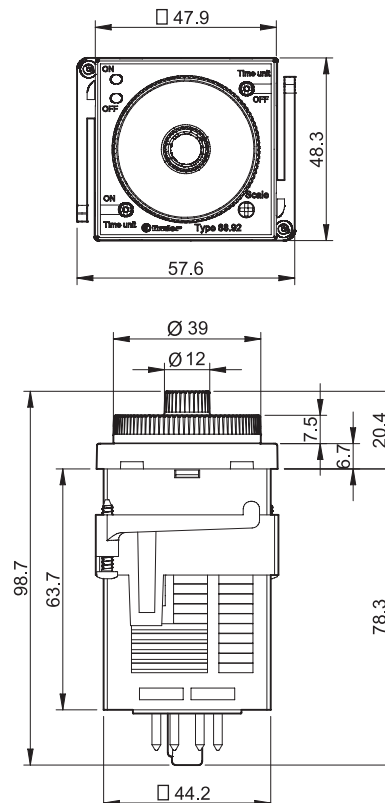

## Selection of: function, time scale and units

	88.02	88.12	88.92 - 0000	88.92 - 0001
<b>Function</b>	AI, DI, GI, SP, BE, CEa, DE	AI a, AI b, DI a, DI b, GI, SW	PI	LI
<b>Time scale</b>	0.5, 1, 5, 10		1.2, 3, 12, 30	
<b>Unit of time</b>	s (second), min (minute), h (hour), 10 h (10 hours)		s (second), 10 s (second x 10), min (minute), 10 min (minute x 10), h (hour), 10 h (hour x 10)	

## Time scales

### Full scale value for types 88.02, 88.12

D \ H	s	min	h	10 h
0.5	0.5 second	0.5 minute	0.5 hour	5 hour
1	1 second	1 minute	1 hour	10 hour
5	5 second	5 minute	5 hour	50 hour
10	10 second	10 minute	10 hour	100 hour

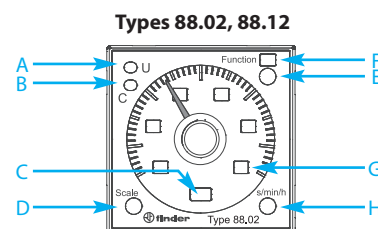

### Full scale value for type 88.92

H \ D-E	s	10 s	min	10 min	h	10 h
1.2	1.2 second	12 second	1.2 minute	12 minute	1.2 hour	12 hour
3	3 second	30 second	3 minute	30 minute	3 hour	30 hour
12	12 second	120 second	12 minute	120 minute	12 hour	120 hour
30	30 second	300 second	30 minute	300 minute	30 hour	300 hour

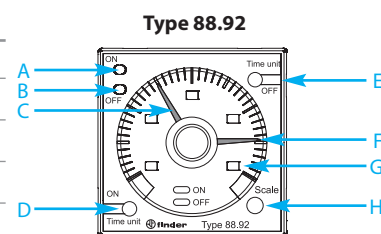

NOTE: time scales and functions must be set before energising the timer.

## LED/visual indication

### Types 88.02, 88.12

<b>A</b>	Yellow LED: power ON (U)
<b>B</b>	Red LED: timing in progress (C)
<b>C</b>	Unit of time selected
<b>D</b>	Time scale selector
<b>E</b>	Function selector
<b>F</b>	Function selected
<b>G</b>	Time scale selected
<b>H</b>	Unit of time selector

### Type 88.92

<b>A</b>	Red LED: pulse ON (T1)
<b>B</b>	Green LED: pulse OFF (T2)
<b>C</b>	Red timing regulator: T1 time setting
<b>D</b>	Unit of time selector: T1 (ON)
<b>E</b>	Unit of time selector: T2 (OFF)
<b>F</b>	Green timing regulator: T2 time setting
<b>G</b>	Time scale selected
<b>H</b>	Time scale selector

Functions for types 88.02, 88.12

	LED (yellow)	LED (red)	Supply voltage	NO output contact	Contact	
					Open	Closed
<b>U</b> = Supply Voltage	—	—	OFF	Open	x1 - x4	x1 - x2
<b>S</b> = Signal switch	—	—	ON	Open	x1 - x4	x1 - x2
<b>P</b> = Pause	■	—	ON	Open (timing in progress)	x1 - x4	x1 - x2
<b>R</b> = Reset	■	■	ON	Closed	x1 - x2	x1 - x4

Wiring diagram

Type 88.02

without control signal

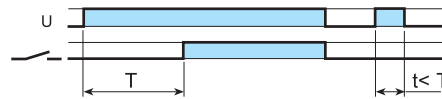
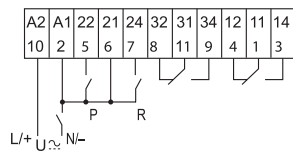

**(AI) On-delay.**

Apply power to timer. Output contacts transfer after preset time has elapsed. Reset occurs when power is removed.

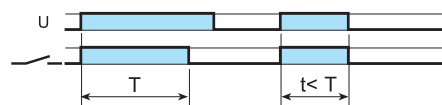

**(DI) Interval.**

Apply power to timer. Output contacts transfer immediately. After the preset time has elapsed, contacts reset.

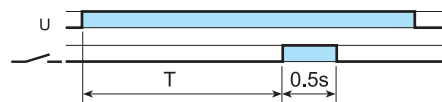

**(GI) Pulse delayed.**

Apply power to timer. Output contacts transfer after preset time has elapsed. Reset occurs after a fixed time of 0.5 s.

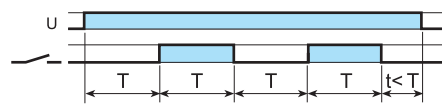

**(SP) Symmetrical flasher (starting pulse off).**

Apply power to timer. First transfer of contact occurs after preset time has elapsed. The timer now cycles between OFF and ON as long as power is applied. The ratio is 1:1 (time on = time off).

with control signal

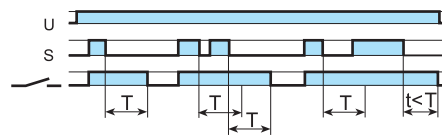
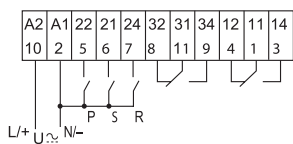

**(BE) Off-delay with control signal.**

Power is permanently applied to the timer. The output contacts transfer immediately on closure of the Signal Switch (S). Opening the Signal Switch initiates the preset delay, after which time the output contacts reset.

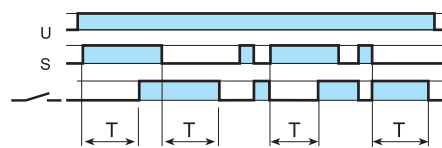

**(CEa) On- and off-delay with control signal.**

Power is permanently applied to the timer. Closing the Signal Switch (S) initiates the preset delay, after which time the output contacts transfer. Opening the Signal switch initiates the same preset delay, after which time the output contacts reset.

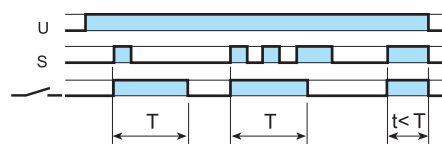

**(DE) Interval with control signal on.**

Power is permanently applied to the timer. On momentary or maintained closure of Signal Switch (S), the output contacts transfer, and remain so for the duration of the preset delay, after which they reset.

**RESET (R)**

A momentary closure of the reset switch (2-7) will reset the timer. Longer term closure of the reset switch will hold the timer in the reset state. This is applicable for all functions.

**PAUSE (P)**

Closure of the pause switch (2-5) will immediately halt the timing process, but the elapsed time will be retained, and the current state of the output contacts will be maintained.

On opening of the pause switch, timing resumes from the retained value. This is applicable for all functions.

Functions for type 88.12

Wiring diagram

Type 88.12

without control signal

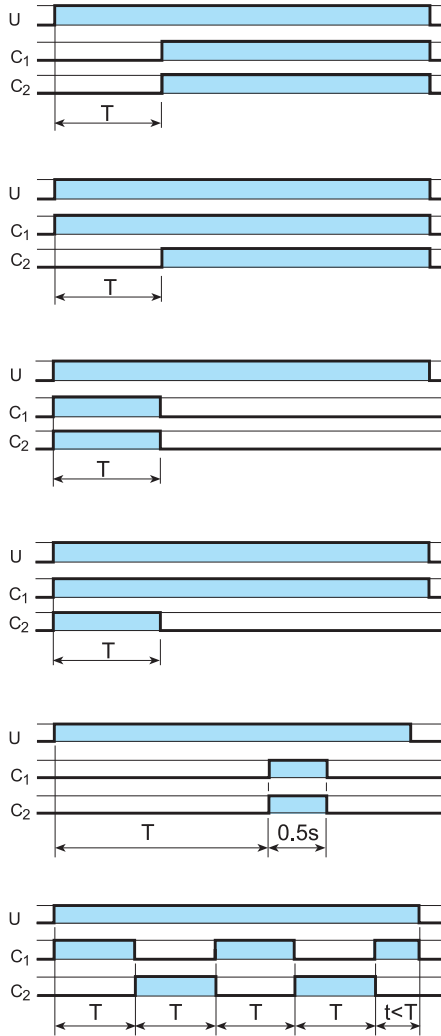
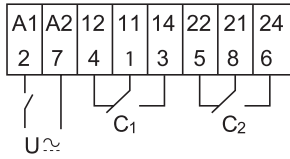

**(AI a) On-delay (2 timed contacts).**

Apply power to timer.  
Contacts (C<sub>1</sub> and C<sub>2</sub>) transfer after preset time has elapsed.  
Reset occurs when power is removed.

**(AI b) On-delay**

**(1 timed contact + 1 instantaneous contact).**

Apply power to timer. Output contact (C<sub>1</sub>) transfers immediately.  
Contact (C<sub>2</sub>) transfers after the preset time has elapsed.  
Reset occurs when power is removed.

**(DI a) Interval (2 timed contacts).**

Apply power to timer.  
Output contacts (C<sub>1</sub> and C<sub>2</sub>) transfer immediately.  
After preset time has elapsed, the contacts reset.

**(DI b) Interval (1 timed contact + 1 instantaneous contact).**

Apply power to timer. Output contacts (C<sub>1</sub> and C<sub>2</sub>) transfer immediately. After preset time has elapsed, the contact (C<sub>2</sub>) resets.  
Contact (C<sub>1</sub>) resets when power is removed.

**(GI) Pulse delayed.**

Apply power to timer. Output contacts transfer after preset time has elapsed. Reset occurs after a fixed time of 0.5 s.

**(SW) Symmetrical flasher (starting pulse on).**

Apply power to timer. Output contacts transfer immediately and cycle between ON and OFF for as long as power is applied.  
The ratio is 1:1 (time on = time off).

Functions for type 88.92

U = Supply Voltage

	LED ON (red)	LED OFF (green)	Supply voltage	Contact	
				Open	Closed
_____	_____	_____	OFF	11 - 14 21 - 24	11 - 12 21 - 22
_____	████████	_____	ON	11 - 12 21 - 22	11 - 14 21 - 24
_____	_____	████████	ON	11 - 14 21 - 24	11 - 12 21 - 22

Wiring diagram

Type 88.92

without control signal

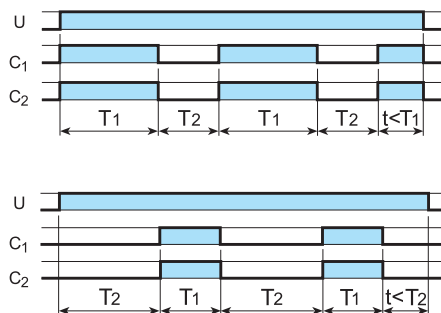
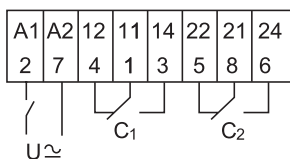

**(LI) Asymmetrical flasher (starting pulse ON).**

Apply power to timer. Output contacts transfer immediately and cycle between ON and OFF for as long as power is applied. The ON and OFF times are independently adjustable.

**(PI) Asymmetrical flasher (starting pulse OFF).**

Apply power to timer. Output contacts transfer after time T<sub>2</sub> has elapsed and cycle between OFF and ON for as long as power is applied. The ON and OFF times are independently adjustable.





90.21

Approvals  
(according to type):



Screw terminal (Box clamp) socket panel or 35 mm rail (EN 60715) mount	90.20 Blue	90.20.0 Black	90.21 Blue	90.21.0 Black
For timer type	88.12, 88.92		88.02	
<b>Technical data</b>				
Rated values	10 A - 250 V			
Dielectric strength	2 kV AC			
Protection category	IP 20			
Ambient temperature	°C -40...+70			
Screw torque	Nm 0.5			
Wire strip length	mm 10			
Max. wire size for 90.20 and 90.21 sockets	solid wire		stranded wire	
	mm <sup>2</sup> 1 x 6 / 2 x 2.5		1 x 6 / 2 x 2.5	
	AWG 1 x 10 / 2 x 14		1 x 10 / 2 x 14	

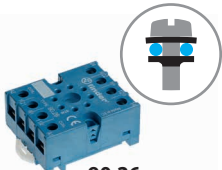
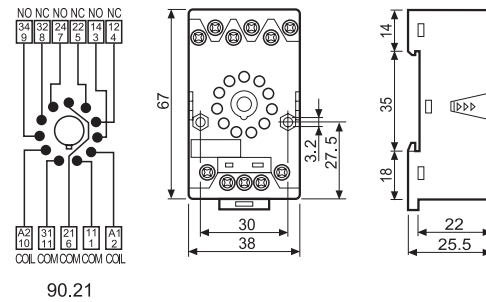
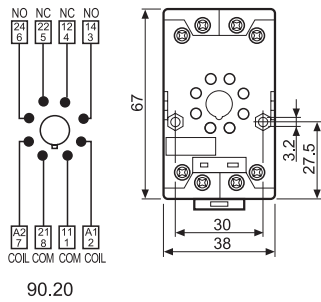

90.26

Approvals  
(according to type):



Screw terminal (Box clamp) socket panel or 35 mm rail (EN 60715) mount	90.26 Blue	90.26.0 Black	90.27 Blue	90.27.0 Black
For timer type	88.12, 88.92		88.02	
<b>Technical data</b>				
Rated values	10 A - 250 V			
Dielectric strength	2 kV AC			
Protection category	IP 20			
Ambient temperature	°C -40...+70			
Screw torque	Nm 0.8			
Wire strip length	mm 10			
Max. wire size for 90.26 and 90.27 sockets	solid wire		stranded wire	
	mm <sup>2</sup> 1 x 4 / 2 x 2.5		1 x 4 / 2 x 2.5	
	AWG 1 x 12 / 2 x 14		1 x 12 / 2 x 14	

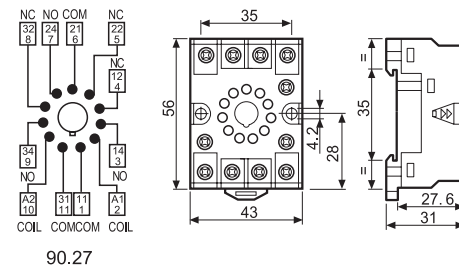
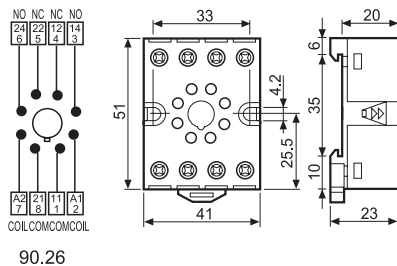



# Timed socket for 34 series



Hoists and cranes



Packaging machines



Traffic light controls



Bottling plant



Carousel warehouses



Control panels



Panels for electrical distribution



Labelling machines

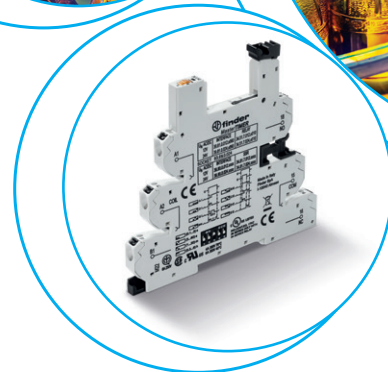
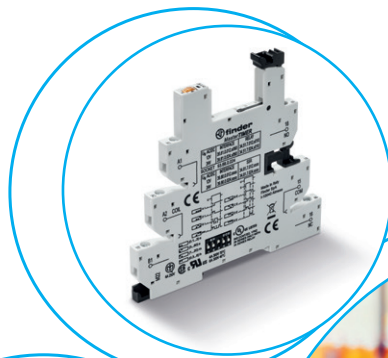

93  
SERIES



**Slim timed sockets for 34 series, 6.2 mm wide**

- Timer adjustment via top mounted rotary knob accessible after assembly
- Control signal terminal
- DIP-switch for selection of 4 time scales and 8 functions
- Output with fuse module option
- EMR and SSR: 12 to 24 V AC/DC supply
- Screw terminal and push-in terminal

93.68  
Screw terminals



93.69  
Push-in terminal

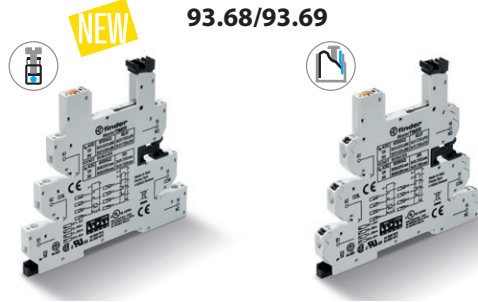

**93.68/93.69**

- Time scale: from 0.1 s to 6 h
- Multi-function
- For use with 34.51 (EMR) and 34.81 (SSR) relays
- Screw terminal and push-in terminal

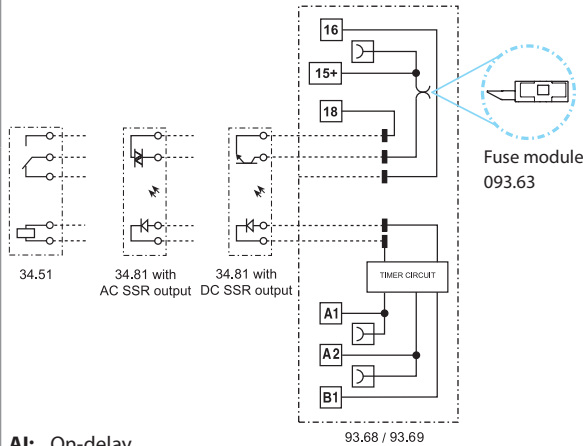

- A1:** On-delay
- D1:** Interval
- G1:** Pulse (0.5 s) delayed
- SW:** Symmetrical flasher (starting pulse on)
- BE:** Off-delay with control signal
- CE:** On- and off-delay with control signal
- DE:** Interval with control signal on
- EE:** Interval with control signal off

For outline drawing see page 5

**Contact specification**

Contact configuration	
Rated current/Maximum peak current	A
Rated voltage/ Maximum switching voltage	V AC
Rated load AC1	VA
Rated load AC15 (230 V AC)	VA
Single phase motor rating (230 V AC)	kW
Breaking capacity DC1: 24/110/220 V	A
Minimum switching load	mW (V/mA)
Standard contact material	

See 34.51 and 34.81 relays

**Supply specification**

Nominal voltage (U <sub>N</sub> )	V AC (50/60 Hz)/DC	12...24
Rated power AC/DC	VA/W	See coils specifications page 4
Operating range	V AC (50/60 Hz)/DC	9.6...26.4

**Technical data**

Specified time range		(0.1...3)s, (3...60)s, (1...20)min, (0.3...6)h
Repeatability	%	± 1
Recovery time	ms	≤ 50
Setting accuracy - full range	%	5
Electrical life at rated load in AC1	cycles	See 34.51 (EMR) and 34.81 (SSR) relays
Ambient temperature range	°C	-20...+50
Protection category		IP 20

**Approvals** (according to type)



## Ordering information

Example: type 93.68 multi-function timer module for 34 series relay, screw terminals, (12...24)V AC/DC supply voltage.

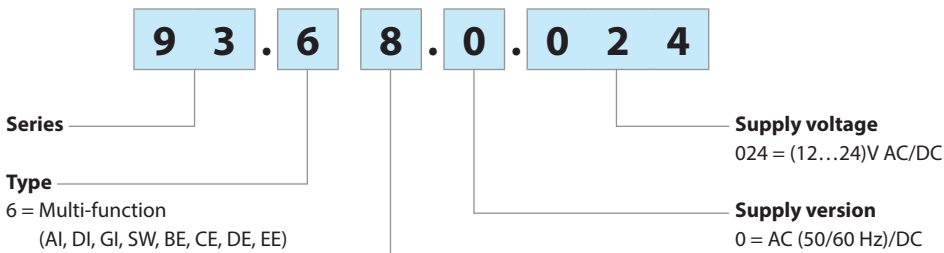

## Combinations

Output	Supply voltage	Type of relay	Type of socket, screw terminals
1 pole 6 A, electromechanical relay	12 V AC/DC	34.51.7.012.0010	93.68.0.024
1 pole 6 A, electromechanical relay	24 V AC/DC	34.51.7.024.0010	93.68.0.024
1 output 6 A/24 V DC, solid state relay	12 V AC/DC	34.81.7.012.9024	93.68.0.024
1 output 2 A/240 V AC, solid state relay	12 V AC/DC	34.81.7.012.8240	93.68.0.024
1 output 6 A/24 V DC, solid state relay	24 V AC/DC	34.81.7.024.9024	93.68.0.024
1 output 2 A/240 V AC, solid state relay	24 V AC/DC	34.81.7.024.8240	93.68.0.024
Output	Supply voltage	Type of relay	Type of socket, push-in terminals
1 pole 6 A, electromechanical relay	12 V AC/DC	34.51.7.012.0010	93.69.0.024
1 pole 6 A, electromechanical relay	24 V AC/DC	34.51.7.024.0010	93.69.0.024
1 output 6 A 24 V DC, solid state relay	12 V AC/DC	34.81.7.012.9024	93.69.0.024
1 output 2 A 240 V AC, solid state relay	12 V AC/DC	34.81.7.012.8240	93.69.0.024
1 output 6 A 24 V DC, solid state relay	24 V AC/DC	34.81.7.024.9024	93.69.0.024
1 output 2 A 240 V AC, solid state relay	24 V AC/DC	34.81.7.024.8240	93.69.0.024

Note: Although the timer socket covers both 12 and 24 V supplies, it must be combined with the appropriate 12 V or 24 V relay; resulting in a combination suitable for just a single supply voltage.

## Technical data

### EMC specifications

Type of test	Reference standard		
Electrostatic discharge	contact discharge	EN 61000-4-2	4 kV
	air discharge	EN 61000-4-2	8 kV
Radio-frequency electromagnetic field	(80 ÷ 1000 MHz)	EN 61000-4-3	10 V/m
	(1400 ÷ 2700 MHz)	EN 61000-4-3	10 V/m
Fast transients (burst) (5-50 ns, 5 and 100 kHz)	on Supply terminals	EN 61000-4-4	4 kV
	on control signal terminals	EN 61000-4-4	4 kV
Surges (1.2/50 µs) on supply and control signal terminals	common mode	EN 61000-4-5	2 kV
	differential mode	EN 61000-4-5	0.8 kV
Radio-frequency common mode (0.15 ÷ 80 MHz)	on Supply terminals	EN 61000-4-6	10 V
	on control signal terminals	EN 61000-4-6	3 V
Radiated and conducted emission	EN 55022		class B

### Other data

Current absorption on signal control (B1)	mA	< 1.7 (12 V) - < 3.5 (24 V)	
Bounce time (EMR) : NO/NC	ms	1/6	
Vibration resistance (EMR, 10...55 Hz): NO/NC	g	10/5	
Power lost to the environment	without contact current	W	0.3
	with rated current	W	0.8

### Terminals

		Solid and stranded cable	
		Screw terminals	Push-in terminals
Wire strip length	mm	10	8
 Screw torque	Nm	0.5	—
Max. wire size	mm <sup>2</sup>	1 x 2.5 / 2 x 1.5	1 x 2.5
	AWG	1 x 14 / 2 x 16	1 x 14
Min. wire size	mm <sup>2</sup>	1 x 0.5	1 x 0.5
	AWG	1 x 21	1 x 21

## Input specifications

### Input data AC/DC timer

Nominal voltage $U_N$	Operating range (AC/DC)		Must drop-out voltage $U_r$	Rated input current at $U_N$		Rated power at $U_N$	
	$U_{min}$	$U_{max}$		DC	AC	DC	AC
V	V	V	V	mA	mA	mA	mA
12	9.6	13.2	1.2	15	23	0.2	0.3/0.2
24	19.2	26.4	2.4	11	19	0.25	0.4/0.3

## Outline drawing

Type 93.68  
Screw terminals

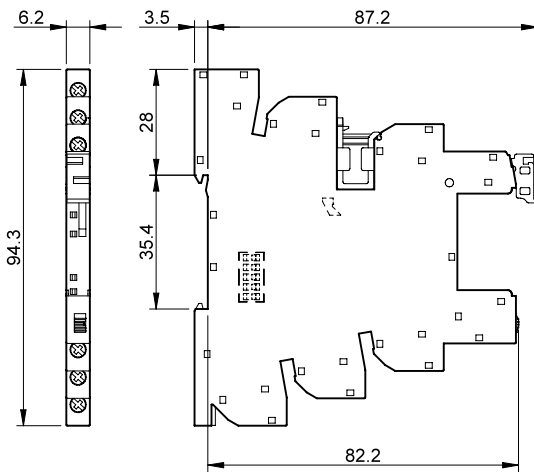

Type 93.69  
Push-in terminal

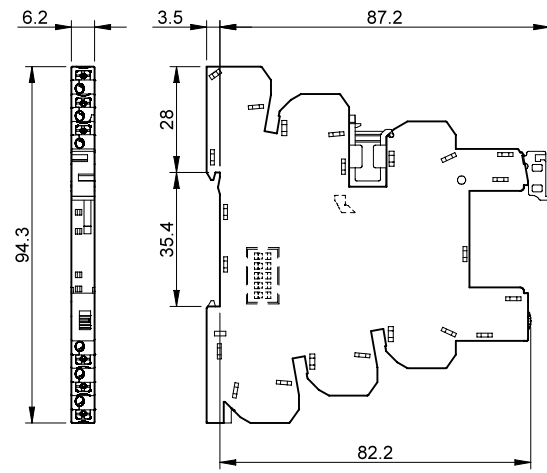

Times scales



Functions

LED	Supply voltage	NO contact/output
	OFF	Open
	ON	Open
	ON	Open (timing to close in progress)
	ON	Closed

Wiring diagram

U = Supply voltage

S = Signal switch

= Output Contact

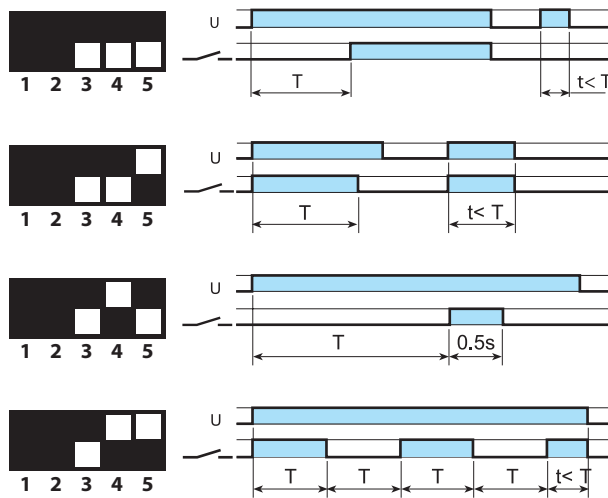
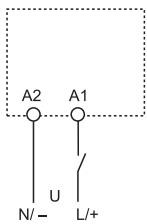

**(AI) On-delay.**

Apply power to timer. Output contacts transfer after preset time has elapsed. Reset occurs when power is removed.

**(DI) Interval.**

Apply power to timer. Output contacts transfer immediately. After the preset time has elapsed, contacts reset.

**(GI) Pulse (0.5 s) delayed.**

Apply power to timer. Output contacts transfer after preset time has elapsed. Reset occurs after a fixed time of 0.5 s.

**(SW) Symmetrical flasher (starting pulse on).**

Apply power to timer. Output contacts transfer immediately and cycle between ON and OFF for as long as power is applied. The ratio is 1:1 (time on = time off).

With control signal

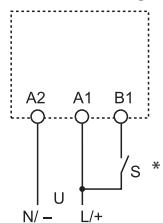

\* With DC supply, positive polarity has to be connected to B1 terminal (according to EN 60204-1).

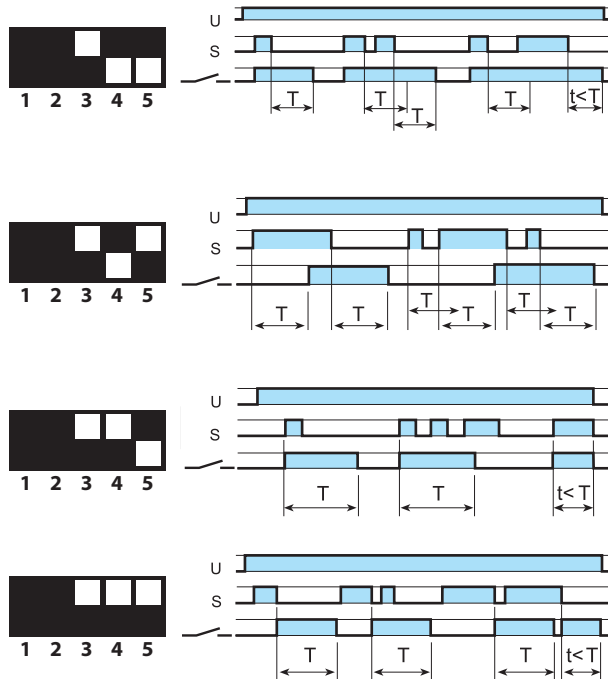

**(BE) Off-delay with control signal.**

Power is permanently applied to the timer. The output contacts transfer immediately on closure of the Signal Switch (S). Opening the Signal Switch initiates the preset delay, after which time the output contacts reset.

**(CE) On- and off-delay with control signal.**

Power is permanently applied to the timer. Closing the Signal Switch (S) initiates the preset delay, after which time the output contacts transfer. Opening the Signal Switch initiates the same preset delay, after which time the output contacts reset.

**(DE) Interval with control signal on.**

Power is permanently applied to the timer. On momentary or maintained closure of Signal Switch (S), the output contacts transfer, and remain so for the duration of the preset delay, after which they reset.

**(EE) Interval with control signal off.**

Power is permanently applied to the timer. On opening of the Signal Switch (S) the output contacts transfer, and remain so for the duration of the preset delay, after which they reset.

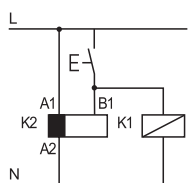

• Possible to control an external load, such as another relay coil or timer, connected to the control signal terminal B1.

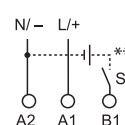

\*\* A voltage other than the supply voltage can be applied to the command Start (B1), example:  
A1 - A2 = 24 V AC  
B1 - A2 = 12 V DC



Accessories



<b>Output fuse module</b>	093.63
---------------------------	--------

- For 5 x 20 mm fuses up to 6 A, 250 V
- Easy visibility of the fuse condition through the window
- Quick connection to socket

**Notes**

**Safety:** Because the output circuit can be reinstated, even with the fuse removed, it is important not to consider the removal of the fuse as a "safety disconnect". Always isolate elsewhere before working on the circuit.

**UL:** According to UL508A, the fuse module cannot be installed in power circuits (in which it is mandatory that a fuse certified according to UL category JDDZ be fitted). However, where the MasterInterface is connected as an output interface to a PLC no such restrictions apply, and the fuse module can be usefully employed.

093.63

Approvals  
(according to type):

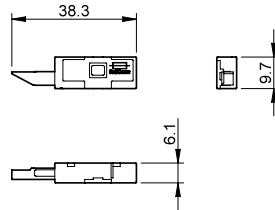

<b>16-way jumper link</b>	093.16 (blue)	093.16.0 (black)	093.16.1 (red)
---------------------------	---------------	------------------	----------------

Rated values 6 A - 250 V

Possibility of multiple connection, side by side

093.16



093.16.0



093.16.1

Approvals  
(according to type):

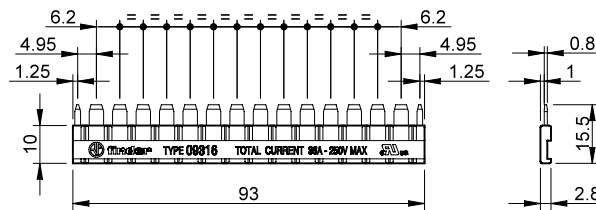

093.60

<b>Dual-purpose plastic separator (1.8 mm or 6.2 mm separation)</b>	093.60
---	--------

1. By breaking off the protruding ribs (by hand), the separator becomes only 1.8 mm thick; useful for the visual separation of different groups of interfaces, or necessary for the protective separation of different voltages of neighbouring interfaces, or for the protection of cut ends of jumper links.



2. Leaving the ribs in place provides 6.2 mm separation. Simply cutting (with scissors) the relevant segment(s) permits the interconnection across the separator of 2 different groups of interface relays, using the standard jumper link.

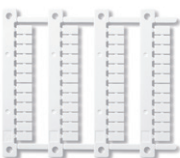

060.48

<b>Sheet of marker tags, plastic, 48 tags, 6 x 12 mm, for CEMBRE thermal transfer printers</b>	060.48
--	--------

## Accessories



093.62

<b>Terminal doubler</b> (for socket Push-in only)		093.62
Total load		6 A - 300 V
Max. wire size	mm <sup>2</sup>	2 x 1.5
	AWG	2 x 16



093.68.14.1

Approvals  
(according to type):

<b>MasterADAPTER</b>	093.68.14.1
----------------------	-------------

The **MasterADAPTER** permits the easy connection of A1/A2 terminals of up to **MasterINTERFACE** modules to PLC outputs via a 14-Pole ribbon cable, plus simple 2-wire power supply connection.

### Technical data

Rated current (per signal path)	A	1
Minimum required supply power	W	3
Nominal voltage (U <sub>N</sub> )	V DC	24
Operating range		(0.8...1.1)U <sub>N</sub>
Control logic		Positive switching (to A1)
Power supply status indication		Green LED
Ambient temperature range	°C	-40...+70

### Terminals for 24 V control logic

Type of connector	14 pole, according to IEC 60603-13
-------------------	------------------------------------

### Terminals for 24 V power supply

Wire strip length	mm	9.5	
 Screw torque	Nm	0.5	
Max. wire size	solid wire	mm <sup>2</sup>	1 x 4 / 2 x 1.5
		AWG	1 x 12 / 2 x 16
	stranded wire	mm <sup>2</sup>	1 x 2.5 / 2 x 1.5
		AWG	1 x 14 / 2 x 16

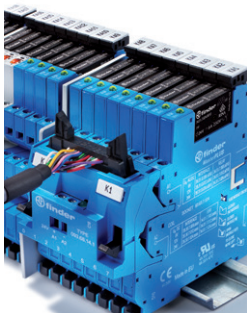
Connected  
**MasterADAPTER**

# Light dependent relays 12 - 16 A



Garden and  
night lighting



Shop displays



Lighting for  
parks



Streetlights  
and car park  
lighting

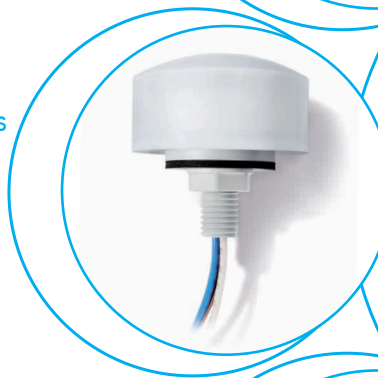

10  
SERIES



**Relays for automatic control of lighting according to the ambient light level**

**Integral light sensor**

**For pole or wall mounting**

**10.32 - 2 NO 16 A output contacts**

**10.41 - 1 NO 16 A output contact**

- Double pole Live and Neutral switching possible with the 10.32
- Sensitivity adjustment from 1 to 80 lux
- Cadmium free contact material
- Cadmium free light sensor (IC photo diode)
- Electronic circuit - transformer isolated
- Italian Patent "light feedback compensation" innovative principle  
Compatible with slow starting gas discharge lamps (up to 10 minutes)
- For the first 3 working cycles the delay time (On and Off) is reduced to zero in order to aid installation
- Available for supply 230 and 120 V AC (50/60 Hz)

**10.32**



- Double pole switching - 2 NO 16 A for Live and Neutral switching

**10.41**



- Single pole switching - 1 NO 16 A for Live switching

For outline drawing see page 8

**Contact specification**

Contact configuration		2 NO (DPST-NO)		1 NO (SPST-NO)	
Rated current/Maximum peak current	A	16/30 (120 A - 5 ms)		16/30 (120 A - 5 ms)	
Rated voltage/Maximum switching voltage	V AC	120/—	230/—	120/—	230/—
Rated load AC1	VA	1900	3700	1900	3700
Rated load AC15	VA	400	750	400	750
Rated current AC5a	A	—	5	—	5
Nominal lamp rating:					
230 V incandescent/halogen W		—	2300	—	2000
fluorescent tubes with electronic ballast W		600	1200	500	1000
fluorescent tubes with electromagnetic ballast W		450	850	400	750
CFL W		250	500	200	400
230 V LED W		—	500	—	400
LV halogen or LED with electronic ballast W		250	500	200	400
LV halogen or LED with electromagnetic ballast W		500	1000	400	800
Minimum switching load	mW (V/mA)	1000 (10/10)		1000 (10/10)	
Standard contact material		AgSnO <sub>2</sub>		AgSnO <sub>2</sub>	
<b>Supply specification</b>					
Nominal voltage (U <sub>N</sub> )	V AC (50/60 Hz)	120	230	120	230
	V DC	—		—	
Rated power AC/DC	VA (50 Hz)/W	2/—		2/—	
Operating range	AC (50 Hz)	(0.8...1.1)U <sub>N</sub>		(0.8...1.1)U <sub>N</sub>	
	DC	—		—	
<b>Technical data</b>					
Electrical life at rated load in AC1	cycles	100 · 10 <sup>3</sup>		100 · 10 <sup>3</sup>	
Threshold setting	lx	1...80		1...80	
Preset threshold	lx	10		10	
Delay time: switching ON/OFF	s	15/30		15/30	
Ambient temperature range	°C	-30...+70		-30...+70	
Protection category		IP 54		IP 54	
<b>Approvals</b> (according to type)					

**Relays for automatic control of lighting according to the ambient light level**
**Integral light sensor**
**For pole or wall mounting**
**10.42 - Two independent 16 A outputs with individual lux setting**
**10.51 - Miniature single 12 A 1 NO output**
**10.61 - Mounting on street light body**

- Sensitivity adjustment from 1 to 80 lux
- Fixed sensitivity 10 lux ( $\pm 20\%$ ) - (10.61 type)
- Cadmium free contact material
- Cadmium free light sensor (IC photo diode)
- Electronic circuit - transformer isolated (10.42 type)
- Italian Patent "light feedback compensation" innovative principle (10.51 type)
- For the first 3 working cycles the delay time (On and Off) is reduced to zero in order to aid installation
- Available for supply 230 and 120 V AC (50/60 Hz)
- Prewired with silicone wire, 500 mm length (10.61 type)

**10.42**

- Two independent outputs - 2 NO 16 A

**10.51**



- Single pole switching - 1 NO 12 A
- Miniature size

**10.61**

- Single pole switching - 1 NO 16 A

For outline drawing see page 8

**Contact specification**

Contact configuration		2 NO (DPST-NO)		1 NO (SPST-NO)		1 NO (SPST-NO)	
Rated current/Maximum peak current	A	16/30 (120 A - 5 ms)		12/25 (80 A - 5 ms)		16/30 (120 A - 5 ms)	
Rated voltage/Maximum switching voltage	V AC	120/—	230/—	120/—	230/—	230/—	
Rated load AC1	VA	1900	3700	1400	2760	3700	
Rated load AC15	VA	400	750	300	600	750	
Rated current AC5a	A	—	5	—	—	5	
Nominal lamp rating:							
230 V incandescent/halogen W		—	2000	—	1200	2000	
fluorescent tubes with electronic ballast W		500	1000	300	600	1000	
fluorescent tubes with electromagnetic ballast W		400	750	200	400	750	
CFL W		200	400	200	350	400	
230 V LED W		—	400	—	350	400	
LV halogen or LED with electronic ballast W		200	400	200	350	400	
LV halogen or LED with electromagnetic ballast W		400	800	300	600	800	
Minimum switching load	mW (V/mA)	1000 (10/10)		1000 (10/10)		1000 (10/10)	
Standard contact material		AgSnO <sub>2</sub>		AgSnO <sub>2</sub>		AgSnO <sub>2</sub>	
<b>Supply specification</b>							
Nominal voltage (U <sub>N</sub> )	V AC (50/60 Hz)	120	230	120	230	230	
	V DC	—		—		—	
Rated power AC/DC	VA (50 Hz)/W	2/—		1.5/—		2.5/—	
Operating range	AC (50 Hz)	(0.8...1.1)U <sub>N</sub>		(0.8...1.1)U <sub>N</sub>		(0.8...1.1)U <sub>N</sub>	
	DC	—		—		—	
<b>Technical data</b>							
Electrical life at rated load in AC1	cycles	100 · 10 <sup>3</sup>		100 · 10 <sup>3</sup>		100 · 10 <sup>3</sup>	
Threshold setting	lx	1...80		1...80		10	
Preset threshold	lx	10		10		10	
Delay time: switching ON/OFF	s	15/30		15/30		15/30	
Ambient temperature range	°C	-30...+70		-30...+70		-30...+70	
Protection category		IP 54		IP 54		IP 54	
<b>Approvals</b> (according to type)							

### Ordering information

Example: 10 series light dependent relay, 2 NO (DPST-NO) 16 A contact, screw terminal connections, 230 V AC supply.

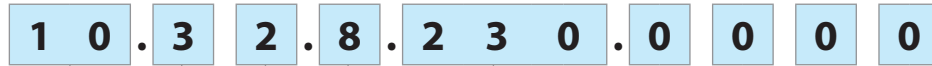

**Series**

**Type**

- 32 = Double output - 2 NO 16 A
- 41 = Single output - 1 NO 16 A
- 42 = Two independent outputs - 2 NO 16 A
- 51 = Single output - 1 NO 12 A
- 61 = Mounting on street light body - 1 NO 16 A

**Supply voltage**

- 120 = 120 V
- 230 = 230 V

**Supply version**

- 8 = AC (50/60 Hz)

### Technical data

Insulation	10.32 / 41 / 42		10.51		10.61	
Dielectric strength between open contacts V AC	1000		1000		1000	
<b>Conducted disturbance immunity</b>						
Surge (1.2/50 µs) on L and N (differential mode) kV	4		4		6	
<b>Other data</b>						
Cable grip	Ø mm	(8.9...12)		(7.5...9)		—
Screw torque	Nm	0.8		0.8		—
Max. wire size		solid cable	stranded cable	solid cable	stranded cable	—
	mm <sup>2</sup>	1 x 6 / 2 x 4	1 x 6 / 2 x 2.5	1 x 6 / 2 x 4	1 x 4 / 2 x 2.5	—
	AWG	1 x 10 / 2 x 12	1 x 10 / 2 x 14	1 x 10 / 2 x 12	1 x 12 / 2 x 14	—
<b>Output wires</b>						
Material	—		—		Silicone rubber UV resistant	
Size	mm <sup>2</sup>	—		—		1.5
Length	mm	—		—		500, ends-ferruled
Rated insulation voltage	kV	—		—		0.6/1
Max temperature	°C	—		—		120

### Functions

LED*	10.32 / 10.41 / 10.42		10.51	
	Supply voltage	NO output contact	Supply voltage	NO output contact
	OFF	Open	OFF or ON	Open
	ON	Open	ON	Closed
	ON	Open (Timing in Progress)	ON	Open (Timing in Progress)
	ON	Closed	—	—

\* The LED is located under the terminal cover, close to the Lux adjustment knob. It indicates the contact status and assists in the test and setting of the correct light threshold level.

Wiring diagrams

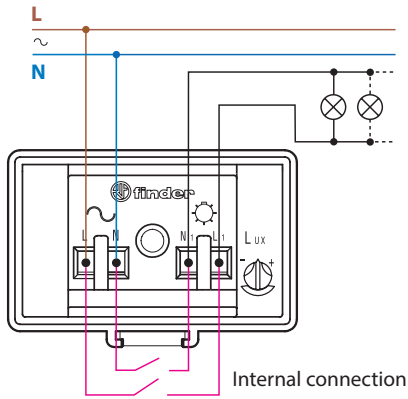

Type 10.32

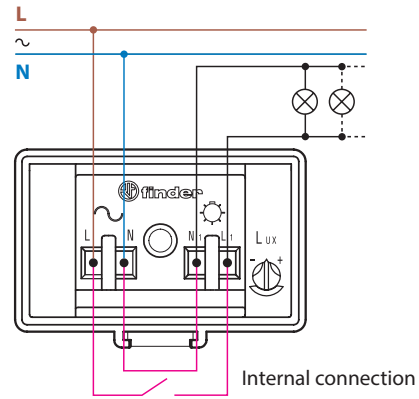

Type 10.41

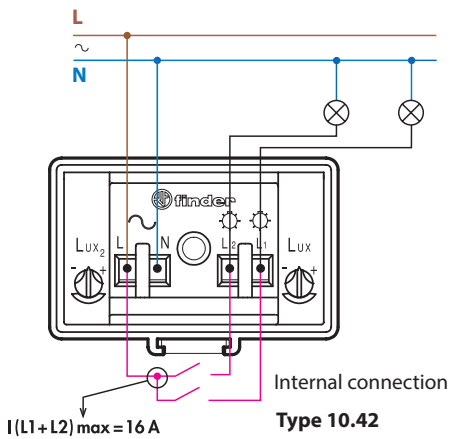

Type 10.42

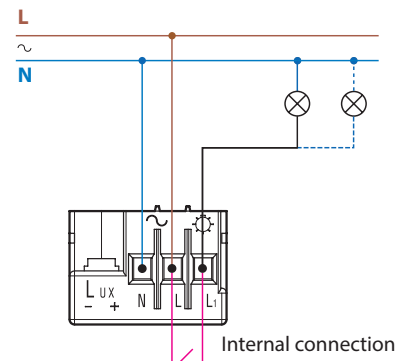

Type 10.51

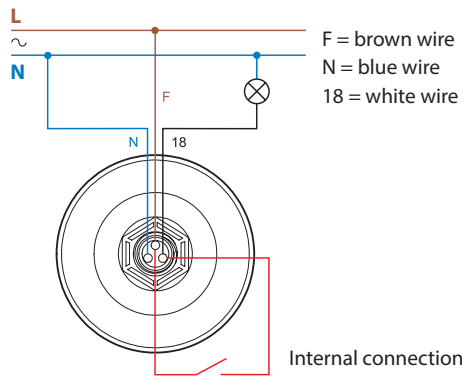

Type 10.61

J



### Advantage of the "light feedback compensation" principle

Light dependent relay where the lighting being controlled does not influence the light level seen by the light sensor

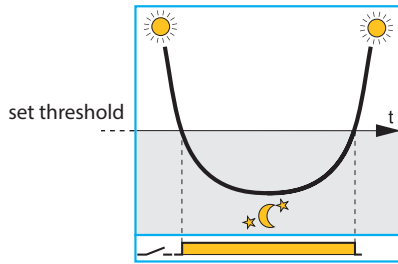

Correct functioning - provided the sensor can be shielded from the effects of the controlled lighting switching On and Off

Traditional light dependent relay where the lighting being controlled influences the light level seen by the light sensor

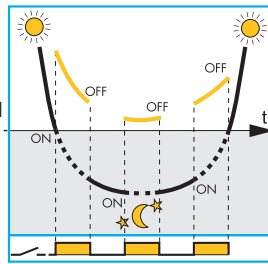

Incorrect functioning where the lamps cycle between On and Off, because their effect is being detected by the light sensor

Type 10.32, 10.41 and 10.51 light dependent relay with "light feedback compensation"

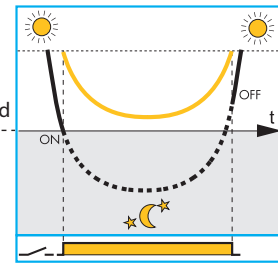

The innovative principle of "light feedback compensation" avoids the annoying and damaging effects of the lamps repeatedly "hunting" between On and Off, due to poor installation

recalculated OFF threshold

Ambient light level as measured by the light dependent relay's integral light sensor.  
 Ambient light + controlled light level as measured by the light dependent relay's integral light sensor.

#### Notes

1. It is good practice to try to achieve a correct installation where the light emitted from the lamp(s) does not influence the light level seen by the sensor, although the "light feedback compensation" principle will help when this is not fully achievable. In this case it should be appreciated that the "light feedback compensation" principle may delay slightly the time of Switch Off - beyond the ideal.
2. The compensation principle is not effective where the combined effect of the ambient light and the controlled lighting exceeds 120 lux.
3. The 10.32 and 10.41 types are compatible with gas discharge lamps that attain full output within 10 minutes, since the electronic circuit monitors lamps' light output over a 10 minutes period to achieve a true assessment of its contribution to the overall lighting level.

Outline drawings

Type 10.32

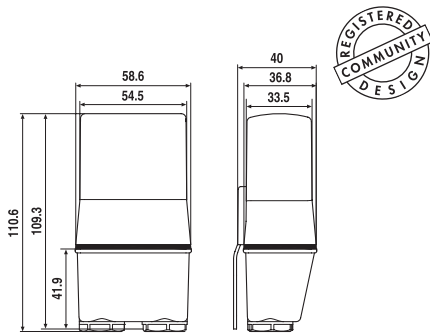

Type 10.41

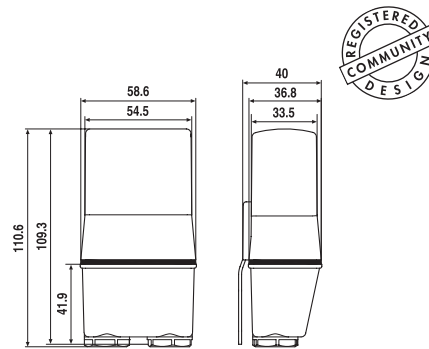

Type 10.42

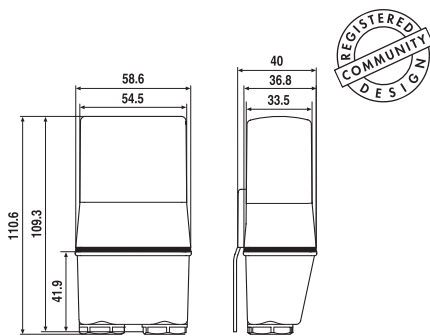

Type 10.51

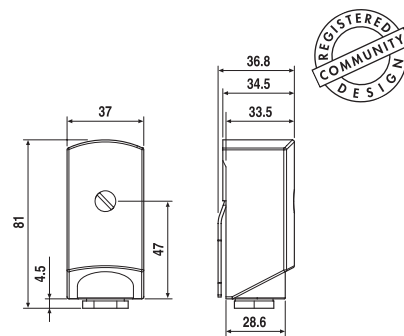

Type 10.61

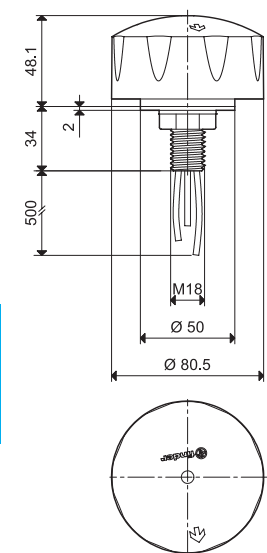

# Light dependent relays 12 - 16 A



Garden and night lighting



Shop displays



Lighting for parks



Streetlights and car park lighting



11  
SERIES



### Relays for automatic control of lighting according to ambient light level - with separate light sensor

#### 11.31 - 1 NO 16 A output contact

- Sensitivity adjustment from 1 to 100 lux
- One module, 17.5 mm wide
- Low energy consumption
- 24 V DC/AC supply version available

#### 11.41 - 1 CO 16 A output contact

- European patent "zero hysteresis" for energy saving
- Italian patent "Light feedback compensation" principle
- Selector with 4 positions:
  - Standard range (threshold setting 1...80 lx)
  - High range (threshold setting 30...1000 lx)
  - continuous light (helpful during installation and initial testing and for maintenance purposes)
  - light off (useful for vacations)
- For the first 3 working cycles the delay time (On and Off) is reduced to zero in order to aid installation
- LED status indication
- SELV separation between contact and supply circuit
- Double insulation between supply and light sensor
- 35 mm rail (EN 60715) mount
- Cadmium free contact material
- Cadmium free light sensor (IC photo diode)

For outline drawing see page 10

#### Contact specification

Contact configuration		1 NO (SPST-NO)	1 CO (SPDT)
Rated current/Maximum peak current	A	16/30 (120 A - 5 ms)	16/30 (120 A - 5 ms)
Rated voltage/Maximum switching voltage	V AC	250/400	250/400
Rated load AC1	VA	4000	4000
Rated load AC15 (230 V AC)	VA	750	750
Nominal lamp rating:			
230 V incandescent/halogen W		2000	2000
fluorescent tubes with electronic ballast W		1000	1000
fluorescent tubes with electromagnetic ballast W		750	750
CFL W		400	400
230 V LED W		400	400
LV halogen or LED with electronic ballast W		400	400
LV halogen or LED with electromagnetic ballast W		800	800
Minimum switching load	mW (V/mA)	1000 (10/10)	1000 (10/10)
Standard contact material		AgSnO <sub>2</sub>	AgSnO <sub>2</sub>

#### Supply specification

Nominal voltage (U <sub>N</sub> )	V AC (50/60 Hz)	12...24	110...230	230
	DC	12...24	—	—
Rated power	VA (50 Hz)/W	2.5/0.9		5.2/2
Operating range	V AC (50 Hz)	10.2...28.8	90...265	(0.8...1.1)U <sub>N</sub>
	DC	10.2...32	—	—

#### Technical data

Electrical life at rated load in AC1	cycles	100 · 10 <sup>3</sup>	100 · 10 <sup>3</sup>
Threshold setting:	Standard range lx	1...100	1...80
	High range lx	—	30...1000
Hysteresis (switching Off/On ratio)		1.25	1
Delay time: switching On/Off	s	15/30	15/30
Ambient temperature range	°C	-20...+50	-20...+50
Protection category: light dependent relay/light sensor		IP 20/IP 54	IP 20/IP 54

#### Approvals (according to type)



- 1 pole
- 17.5 mm wide



- 1 pole
- "zero hysteresis"
- 4 position selector

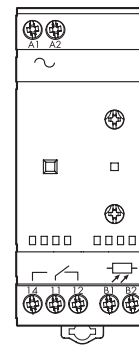

**Relays for automatic control of lighting according to ambient light level - with separate light sensor**

**11.42 - 1 CO + 1 NO 12 A output contacts**

- Two independent outputs with individual lux setting
- Selector with 4 positions:
  - Standard range (threshold setting 1...80 lx)
  - High range (threshold setting 20...1000 lx)
  - continuous light (helpful during installation and initial testing and for maintenance purposes)
  - light off (useful for vacations)
- For the first 6 working cycles (in total for channels 1 & 2) the delay time (On and Off) is reduced to zero in order to aid installation
- LED status indication

**11.91 - 1 CO 16 A output contact (+ auxiliary output for Power Module)**

- Daily time switch function - programmable to inhibit main output (for energy saving)
- Auxiliary output - directly driven by the photosensor
- Italian patent "Light feedback compensation" principle
- Sensitivity adjustment from 1 to 150 lux
- LCD status indication, set-up and programming
- Internal battery for set-up/programming without supply and for time/program back-up in case of power failure (5 years)
- Low stand-by power consumption
- SELV separation between contact and supply circuit
- Double insulation between supply and light sensor
- 35 mm rail (EN 60715) mount
- Cadmium free contact material
- Cadmium free light sensor (IC photo diode)

For outline drawing see page 10

**Contact specification**

Contact configuration	1 CO (SPDT) + 1 NO (SPST-NO)	1 CO (SPDT) + 1 aux output*
Rated current/Maximum peak current	A 12/24 (120 A - 5 ms)	16/30 (120 A - 5 ms)
Rated voltage/Maximum switching voltage	V AC 250/400	250/400
Rated load AC1	VA 3000	4000
Rated load AC15 (230 V AC)	VA 750	750
Nominal lamp rating:		
230 V incandescent/halogen W	2000	2000
fluorescent tubes with electronic ballast W	1000	1000
fluorescent tubes with electromagnetic ballast W	750	750
CFL W	400	400
230 V LED W	400	400
LV halogen or LED with electronic ballast W	400	400
LV halogen or LED with electromagnetic ballast W	800	800
Minimum switching load	mW (V/mA) 1000 (10/10)	1000 (10/10)
Standard contact material	AgSnO <sub>2</sub>	AgSnO <sub>2</sub>

**Supply specification**

Nominal voltage (U <sub>N</sub> )	V AC (50/60 Hz) 230	110...230
	DC —	110...230
Rated power	VA (50 Hz)/W 7.4/2.8	5/2.1
Operating range	V AC (50 Hz) (0.8...1.1)U <sub>N</sub>	(0.8...1.1)U <sub>N</sub>
	DC —	(0.8...1.1)U <sub>N</sub>

**Technical data**

Electrical life at rated load in AC1	cycles 100 · 10 <sup>3</sup>	100 · 10 <sup>3</sup>
Threshold setting:	Standard range lx 1...80	1...150
	High range lx 20...1000	—
Hysteresis (switching Off/On ratio)	1.25	Δ = 3 lx
Delay time: switching On / Off	s 15/30	25/50
Ambient temperature range	°C -20...+50	-20...+50
Protection category: light dependent relay/light sensor	IP 20/IP 54	IP 20/IP 54

**Approvals (according to type)**



**11.42**

- 2 independent outputs
- 2 individual lux settings
- 4 position selector

**11.91**

- Light dependent relay + time switch
- Auxiliary output (light dependent) with 19.91 power module available

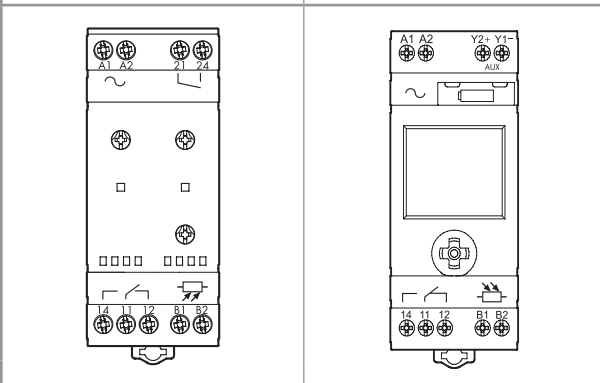

\* 11.91 auxiliary output: 12 V DC, 1 W max

## Ordering information

Example: 11 series light dependent relay with time switch, 1 CO (SPDT) 16 A contact, 230 V AC supply.

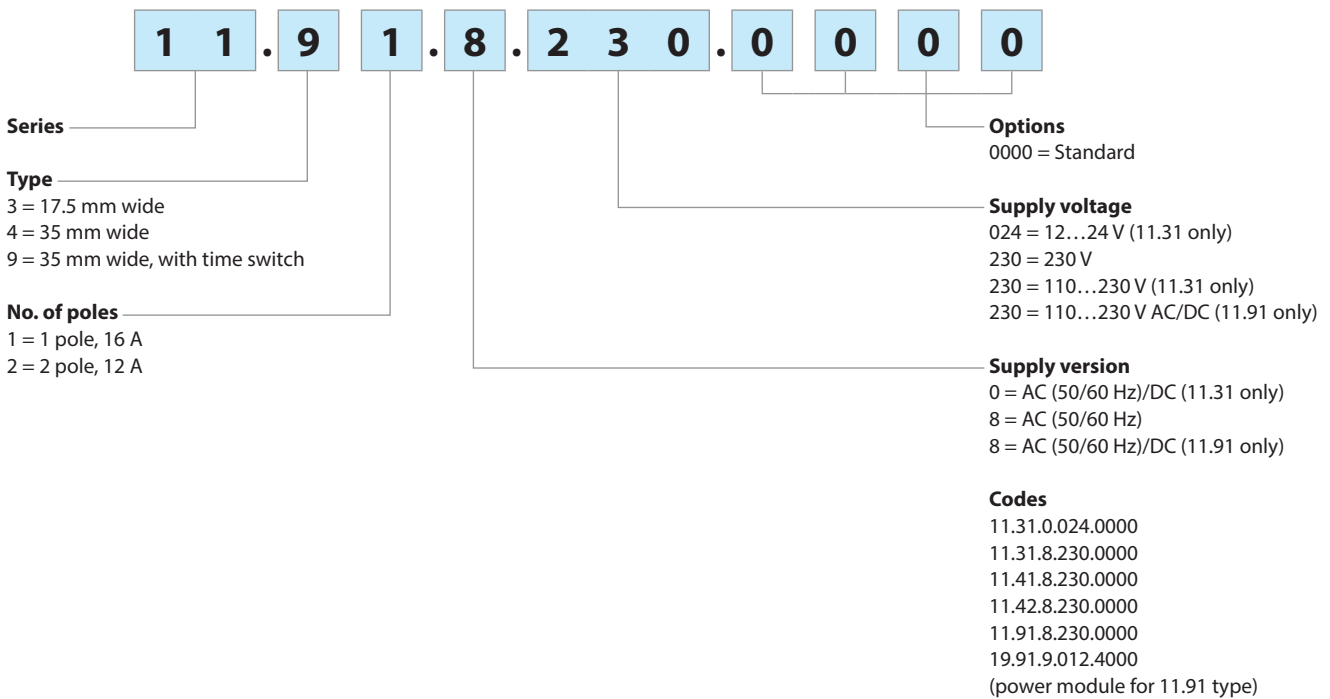

## Technical data

Insulation		Dielectric strength	Impulse (1.2/50 μs)		
	between supply and contacts	4000 V AC	6 kV		
	between supply and light sensor	2000 V AC	4 kV		
	between open contacts	1000 V AC	1.5 kV		
EMC specifications					
Type of test		Reference standard	11.31	11.41 / 42 / 91	
Electrostatic discharge	contact discharge	EN 61000-4-2		4 kV	
	air discharge	EN 61000-4-2		8 kV	
Radiated electromagnetic field (80...1000 MHz)		EN 61000-4-3		10 V/m	
Fast transients (burst 5/50 ns, 5 and 100 kHz)	on supply terminals	EN 61000-4-4	3 kV	4 kV	
	on light sensor connection	EN 61000-4-4	3 kV	4 kV	
Voltage pulses on supply terminals (surge 1.2/50 μs)	common mode	EN 61000-4-5		4 kV	
	differential mode	EN 61000-4-5	3 kV	4 kV	
Radiofrequency common mode voltage (0.15...80 MHz)	on supply terminals	EN 61000-4-6		10 V	
	on light sensor	EN 61000-4-6		3 V	
Voltage dips	70% U <sub>N</sub> , 40% U <sub>N</sub>	EN 61000-4-11		10 cycles	
Short interruptions		EN 61000-4-11		10 cycles	
Radio frequency conducted emissions	0.15...30 MHz	EN 55014		class B	
Radiated emissions	30...1000 MHz	EN 55014		class B	
Terminals					
Screw torque	Nm	0.8			
Max. wire size	solid cable	1 x 6 / 2 x 4 mm <sup>2</sup>	1 x 10 / 2 x 12 AWG		
	stranded cable	1 x 4 / 2 x 2.5 mm <sup>2</sup>	1 x 12 / 2 x 14 AWG		
Wire strip length	mm	9			
Other data					
Cable grip of light sensor	mm	7.5...9			
Maximum cable length relay to light sensor	m	50 (2 x 1.5 mm <sup>2</sup> )			
Preset threshold	lx	10			
Power lost to the environment		<b>11.31</b>	<b>11.41</b>	<b>11.42</b>	<b>11.91</b>
	in stand-by W	0.3	1.3	1.4	0.5
	without contact current W	0.9	2.0	2.8	2.1
	with rated current W	1.7	2.6	3.8	2.7

Wiring diagrams

Type 11.31

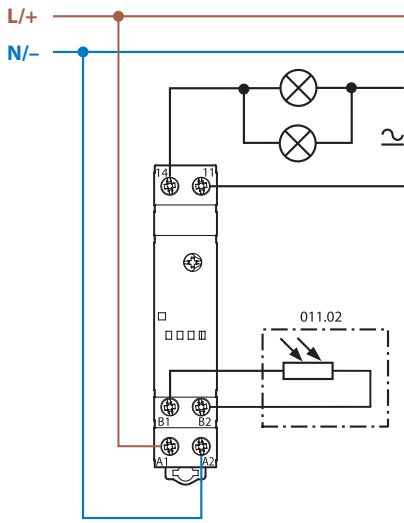

Type 11.42

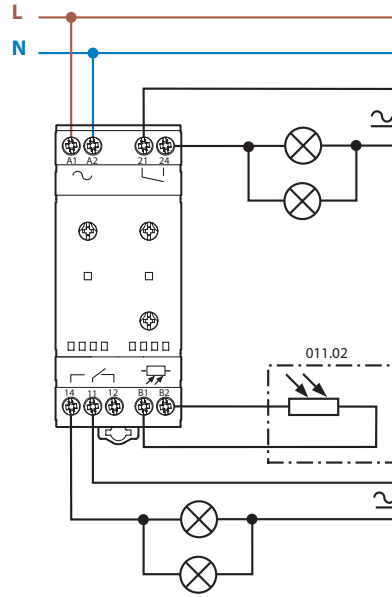

Type 11.41

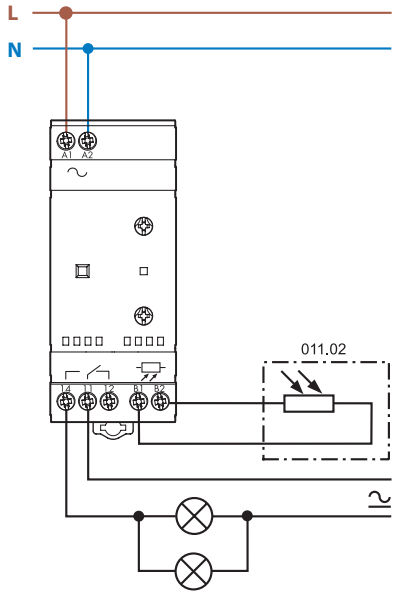

Type 11.91

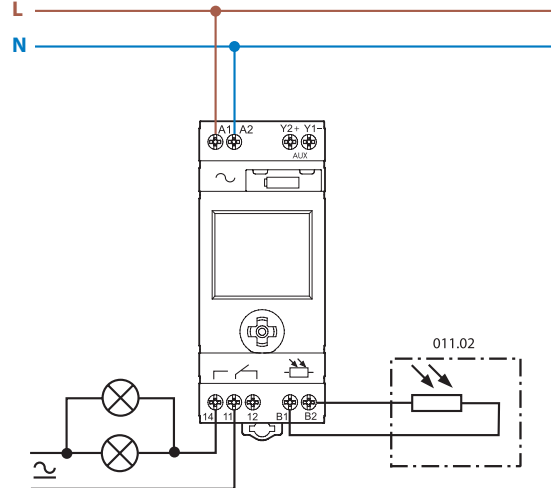

Type 11.91 + 19.91

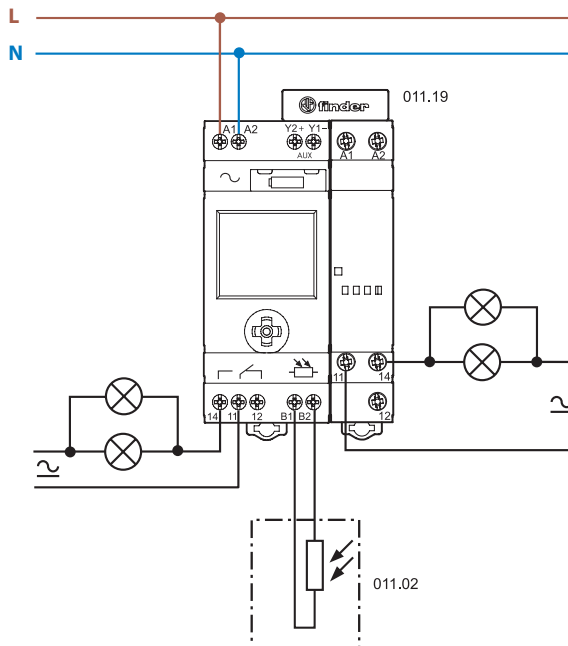

J



## Advantage of the “zero hysteresis” patented circuit:

ensures reliable switching without wasting energy

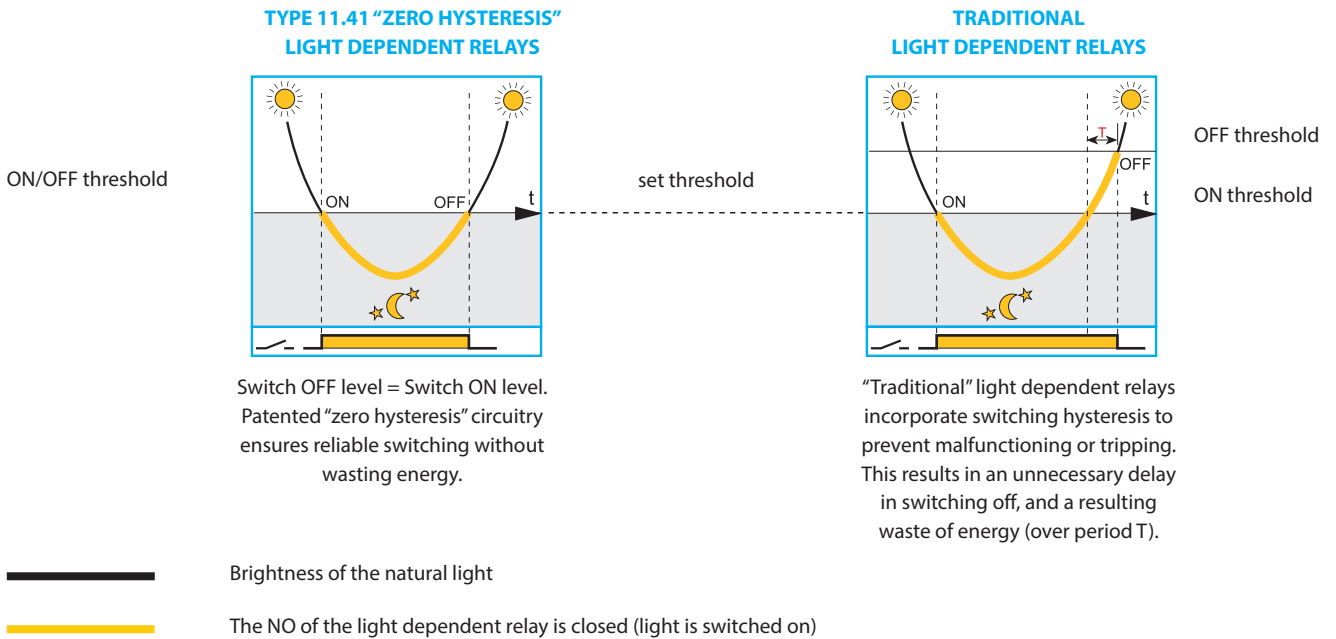

## Advantage of the “light feedback compensation” principle:



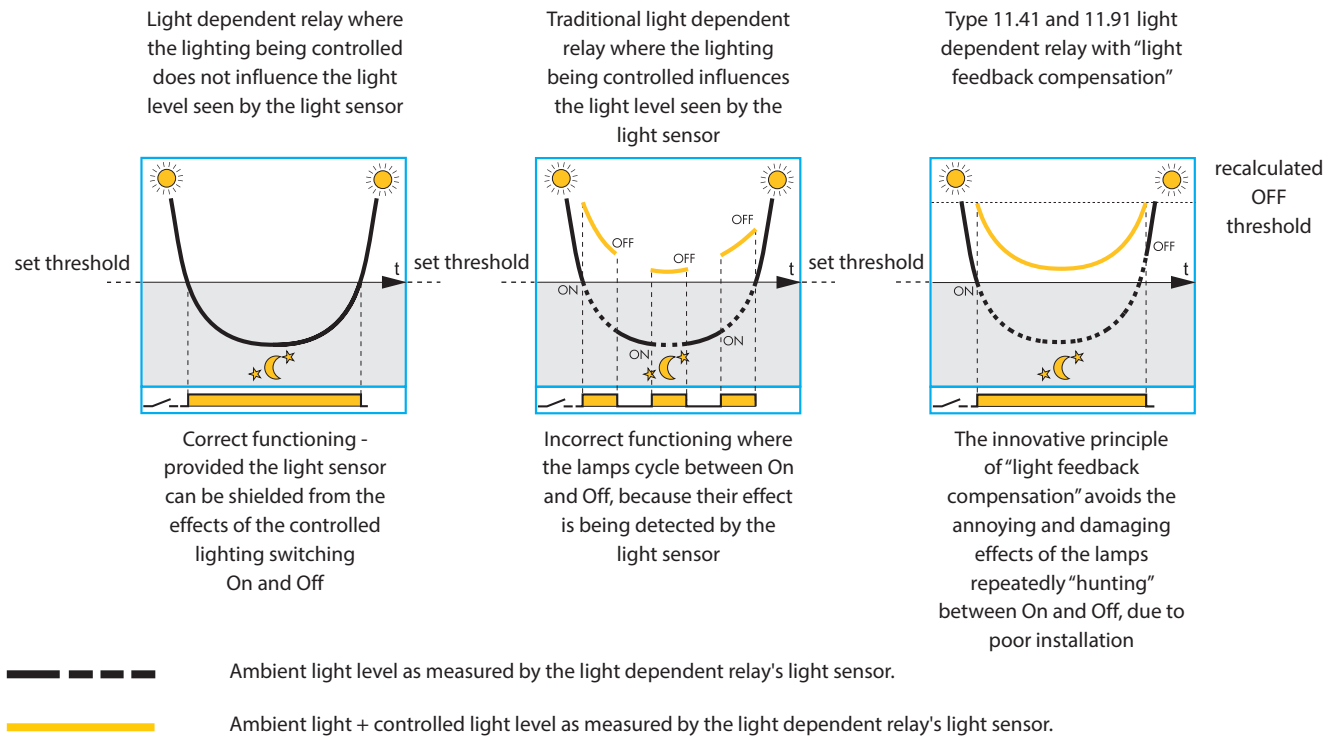



avoids the effect of the lamps repeatedly “hunting” between On and Off, due to poor installation

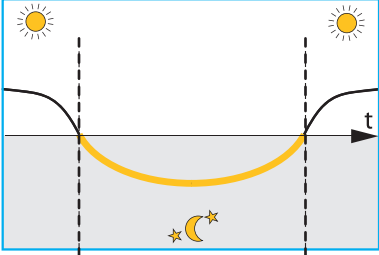

### Notes

1. It is good practice to try to achieve a correct installation where the light emitted from the lamp(s) does not influence the light level seen by the light sensor, although the “light feedback compensation” principle will help when this is not fully achievable. In this case it should be appreciated that the “light feedback compensation” principle may delay slightly the time of Switch Off - beyond the ideal.
2. The compensation principle is not effective where the combined effect of the ambient light and the controlled lighting exceeds a maximum value (200 lux for the 11.91, 160/2000 lux for standard/high range of the 11.41).
3. The 11.41 and 11.91 types are compatible with gas discharge lamps that attain full output within 10 minutes, since the electronic circuit monitors lamps' light output over a 10 minute period to achieve a true assessment of its contribution to the overall lighting level.

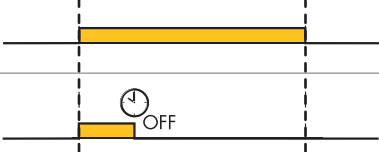
Functions 11.91

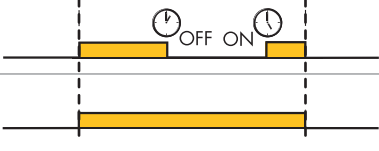
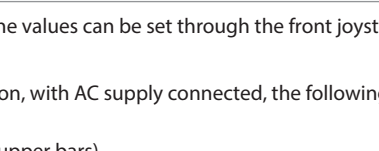
	Switch-OFF time	Switch-ON time				t	Application examples
	NO	NO					Working as a standard light-dependent relay
 11 14	YES 	NO					Working where lighting is not required from 10 PM onwards
	YES 	YES 					Working where lighting is not required between 1 AM and 5 AM
AUX Y1 Y2							Additional output - light dependent without time switch intervention

All the functions and the values can be set through the front joystick and are displayed on the front LCD.



**Display mode**

During normal operation, with AC supply connected, the following is displayed:

- the current time
- the current lux level (upper bars)
- the set lux threshold (lower bars)
- the status (open/closed) of the 11-14 output contact
- the "moon" symbol (only if the current lux level is lower than the set threshold). It also indicates that the Auxiliary output is On, although the main output contact 11-14 may be On, depending on the chrono program.
- the "chrono" symbol (only if a switch-off time is enabled).

From **Display mode** it is possible to enter **Program mode** or **Set-up mode** with a short or long (> 2 s) press respectively, to the joystick centre. From **Display mode** it is also possible to enter **Hand mode**, where (independently of the lux level and the Chrono program) the 11-14 output contact is forced into the On or Off position with a long (> 2 s) press of the joystick upper or lower quadrants, respectively. The "hand" symbol is then displayed. A long press to the opposite quadrant will reset the hand mode.

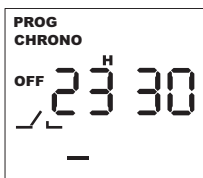

**Program mode**

In this mode it is possible to set the lux threshold level, to enable and to set the switch-off time, to enable and to set the switch-on time. With a short press to the joystick right or left quadrant it is possible to progress from one program step to another (accepting the values set). At any program step it is possible to modify the set values with a short press to the joystick upper or lower quadrant. A long (> 1 s) press allows the fast increment (or decrement) of values. A short press to the joystick centre will resume the display mode.

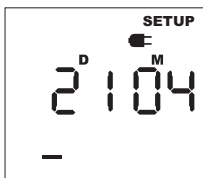

**Set-up mode**

In this mode it is possible to set the current year, month, day, hour and minute (in this order) and to enable european "Daylight saving".

With a short press to the joystick right or left quadrant it is possible to progress from one set-up step to another (accepting the values set); in any step it is possible to modify the set values with a short press to the joystick upper or lower quadrant. A long (> 1 s) press allows the fast increment (or decrement) of values.

A short press to the joystick centre will resume the display mode.

Note: the product is supplied with central european time factory set and "Daylight saving" enabled.

**Power-off mode**

If the 230 V AC supply is not connected, the relay enters power-off mode and to ensure the long life of the built-in back-up battery only the clock is maintained active. The display turns off and no other operation (including light measurement) is performed.

With a press to the joystick during power-off mode it is possible to "awaken" the device and to enter program or set-up mode (the "electrical plug" symbol is displayed); after about 1 minute inactivity the power-off mode is resumed.

Note: with the supply not connected, the program or set-up modes absorb a higher current than the power-off mode, thus influencing the battery life.

**Auxiliary output**

A solid state output at terminals Y1-Y2 is provided (rated 12 V DC, 80 mA/1 W max.): this can be used with the power module **19.91.9.012.4000** connected by the dedicated **011.19** connector. Or, it is possible to connect a suitable relay (for example, 38-48-49-4C-58-59 interface module) provided the coil is within the rating, and the wiring does not exceed 40 cm length. The auxiliary output is driven exclusively by the light sensor of the device, and is consequently independent of the time switch. With the main contact, this permits a flexible lighting system controlled by the ambient light, both with and without the influence of the time switch function.



19.91 power module specification		
Contact configuration		1 CO (SPDT)
Rated current/Maximum peak current ( $I_N/I_{max}$ )	A	16/30 (120 A – 5 ms)
Rated voltage/Maximum switching voltage ( $U_N/U_{max}$ )	V AC	250/400
Rated load AC15 (230 V AC)	VA	750
Nominal lamp rating:		
	230 V incandescent/halogen W	2000
	fluorescent tubes with electronic ballast W	1000
	fluorescent tubes with electromagnetic ballast W	750
	CFL W	400
	230 V LED W	400
	LV halogen or LED with electronic ballast W	400
	LV halogen or LED with electromagnetic ballast W	800
Nominal supply voltage ( $U_N$ )	V DC	12
Ambient temperature range	°C	-20...+50
Protection category		IP 20

**Type 11.31/41/42**

LED	Supply voltage	NO output contact	
		11.41/11.42	11.31
	OFF	Open	Open
	ON	Open	Open
	ON	Open (timing to close in progress)	Open (timing to close in progress)
	ON	Closed	Closed
	ON	Closed (timing to open in progress)	Closed (timing to open in progress)
	ON	Fixed position (On or Off on selector)	—

## Outline drawings

Type 11.31  
Screw terminal

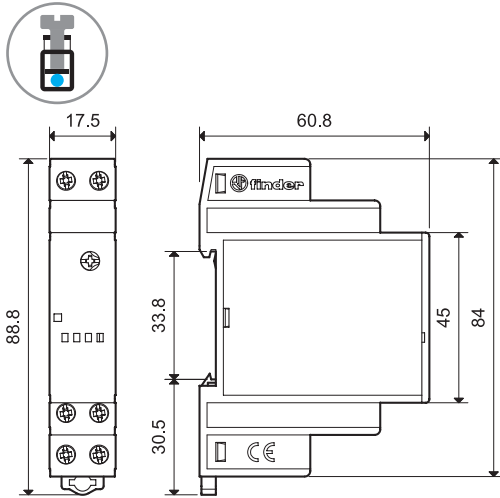

Type 11.42  
Screw terminal

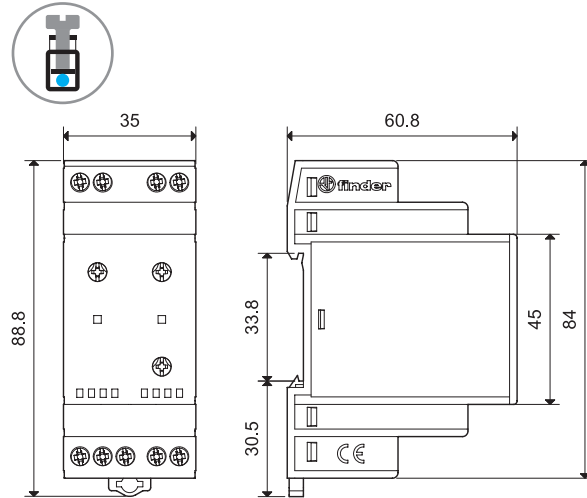

Type 11.41  
Screw terminal

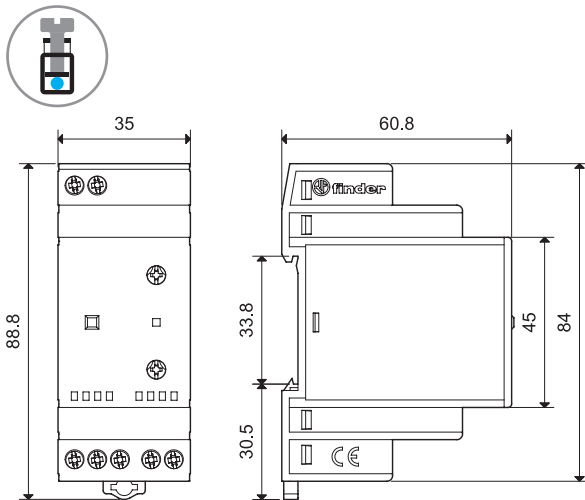

Type 11.91  
Screw terminal

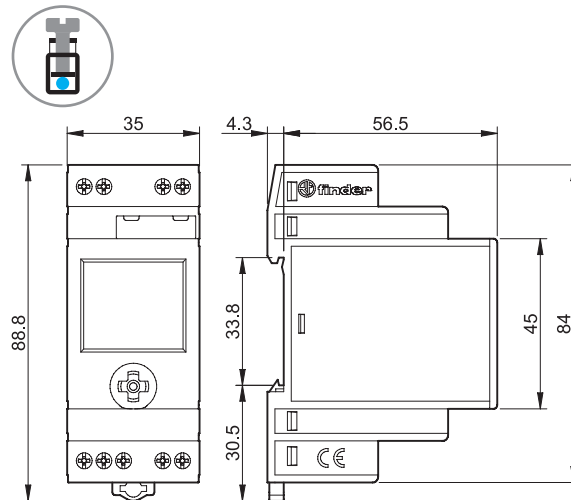

Type 19.91 (power module for 11.91)  
Screw terminal

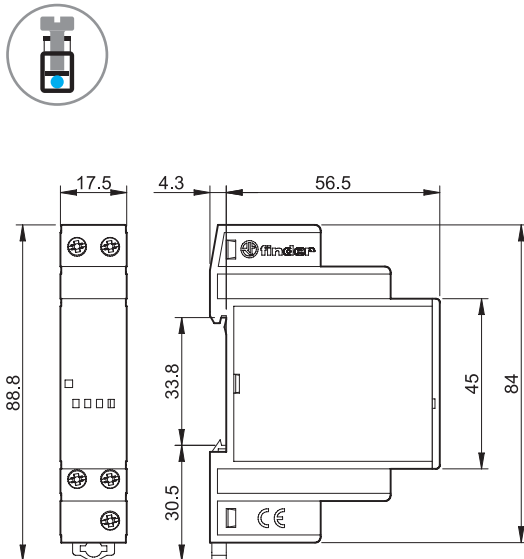

Types 11.91 + 19.91 power module  
Screw terminal

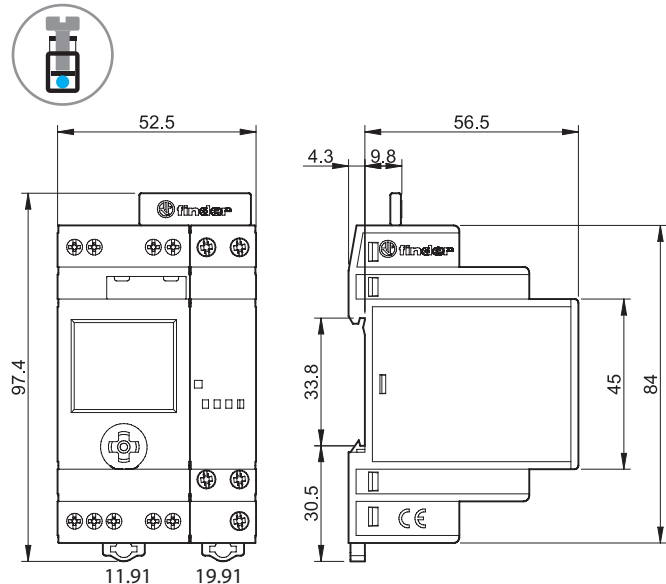

Accessories



011.02

**Light sensor** (supplied with light dependent relay) IP 54 011.02

- Ambient temperature range: -40...+70 °C
- Cadmium free
- Non polarized
- Double insulated with respect to light dependent relay supply
- Not compatible with old 11.01 and 11.71 light dependent relay

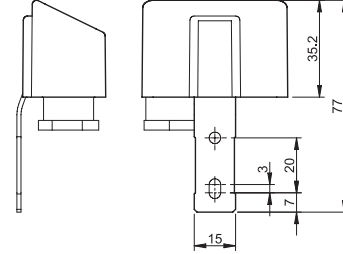
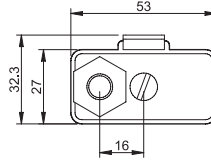

011.03

**Flush-mounted light sensor\*** 011.03

- Protection category: IP 66/67
- Ambient temperature range: -40...+70 °C
- Cadmium free
- Non polarized
- Double insulated with respect to light dependent relay supply
- Not compatible with old 11.01 and 11.71 light dependent relay

\* Purchased separately or included with products with **POA** packaging code (11.31.0.024.0000 POA - 11.31.8.230.0000 POA - 11.41.8.230.0000 POA)

Connection cable	
Material	PVC, flame retardant
Conductor size	mm <sup>2</sup> 0.5
Cable length	mm 500
Cable diameter	mm 5.0
Working voltage	V 300/500
Test voltage, cable	kV 2.5
Max. temperature	°C +90

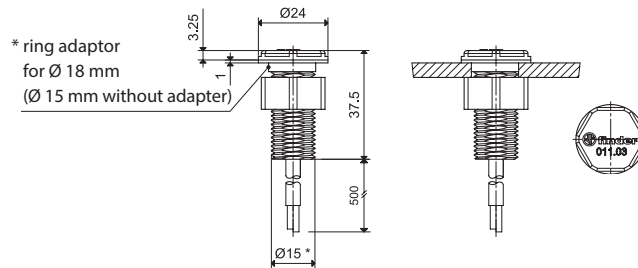

011.01

**Adaptor for panel mounting** (supplied with light dependent relay), 35 mm wide 011.01

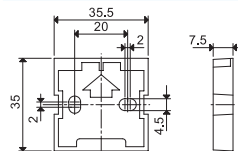

011.19

**2-pole connector** (for type 11.91 and 19.91 power module) 011.19

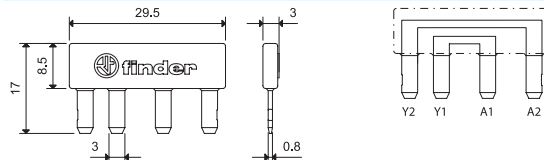

For direct connection of 11.91 auxiliary output (Y1-Y2) to 19.91 supply (A1-A2)

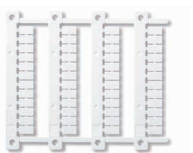

060.48

**Sheet of marker tags**, for types 11.31, 11.41, 11.42, 19.91, plastic, 48 tags, 6 x 12 mm, for CEMBRE thermal transfer printers 060.48



019.01

**Identification tag**, for types 11.41 and 11.42, plastic, 1 tag, 17 x 25.5 mm 019.01



# Time switches 16 A



Heating and cooling



Shop displays



Lighting for parks



Streetlights and car park lighting



School bells



12  
SERIES





**Mechanical time switches**

- Daily time setting\*
- Weekly time setting\*\*

**Type 12.01**

- Daily
- 1 CO 16 A
- 35.8 mm wide
- 35 mm rail mount

**Type 12.11**

- Daily
- 1 NO 16 A
- 17.5 mm wide
- 35 mm rail mount

**Type 12.31-0000**

- Daily
- 1 CO 16 A
- 72 x 72 mm
- Front panel mount

**Type 12.31-0007**

- Weekly
- 1 CO 16 A
- 72 x 72 mm
- Front panel mount

- Minimum time interval setting:  
1 h (12.31-0007)  
30 min (12.01)  
15 min (12.11 - 12.31-0000)

\* Same program every day

\*\* Different program possible for each of the 7 days of the week

For outline drawing see page 15

**12.01**



- Mechanical daily time switch
- 1 CO 16 A
- 35 mm rail (EN 60715) mount

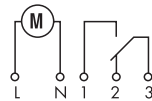

**12.11**



- Mechanical daily time switch
- 1 NO 16 A
- 35 mm rail (EN 60715) mount

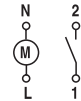

**12.31**



- Mechanical daily or weekly
- 1 CO 16 A
- Front panel mounting

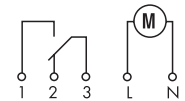

**Contact specification**

Contact configuration		1 CO (SPDT)	1 NO (SPST-NO)	1 CO (SPDT)
Rated current/Maximum peak current	A	16/—	16/30	16/—
Rated voltage/ Maximum switching voltage	V AC	250/—	250/—	250/—
Rated load AC1	VA	4000	4000	4000
Rated load AC15 (230 V AC)	VA	750	420	420
Nominal lamp rating:				
incandescent (230 V) W		2000 (NO contact)	2000	2000
compensated fluorescent (230 V) W		750 (NO contact)	750	750
uncompensated fluorescent (230 V) W		1000 (NO contact)	1000	1000
halogen (230 V) W		2000 (NO contact)	2000	2000
Minimum switching load	mW (V/mA)	1000 (10/10)	1000 (10/10)	1000 (10/10)
Standard contact material		AgSnO <sub>2</sub>	AgSnO <sub>2</sub>	AgSnO <sub>2</sub>

**Supply specification**

Nominal voltage (U <sub>N</sub> )	V AC (50/60 Hz)	230	230	120 - 230
	V DC	—	—	—
Rated power AC/DC	VA (50 Hz)/W	2/—	2/—	2/—
Operating range	AC (50 Hz)	(0.85...1.1)U <sub>N</sub>	(0.85...1.1)U <sub>N</sub>	(0.85...1.1)U <sub>N</sub>
	DC	—	—	—

**Technical data**

Electrical life at rated load in AC1	cycles	50 · 10 <sup>3</sup>	50 · 10 <sup>3</sup>	50 · 10 <sup>3</sup>
Type of time switch		daily	daily	daily   weekly
Switching intervals /day		48	96	96   24 (168/week)
Minimum switching interval	min	30	15	15   60
Accuracy	s/day	1.5	1.5	1.5
Ambient temperature range	°C	-5...+50	-5...+50	-10...+50
Protection category		IP 20	IP 20	IP 20

**Approvals (according to type)**



**Type 12.51**

**Digital (analogue-style) time switch, daily/weekly programming**

- Can be programmed in "Classic" mode via the joystick, or "Smart" mode via smartphones with NFC communication
- Minimum time interval setting - 30 minutes
- Easily configurable for daily or weekly programming

**Type 12.81**

**Digital Astro-switch**

- Can be programmed in "Classic" mode via the joystick, or "Smart" mode via smartphones with NFC communication
- Astro program: calculation of sunrise and sunset times through date, time and location coordinates
- Option for Astro ON period override, by timeswitch
- Location coordinates easily settable for most European countries through post codes
- Offset function: allows programming of switching times offset from the astronomic time (by up to 90 min, in 10 min steps)
- Summer/Winter European, Australian, Brazilian time
- 1 CO 16 A output contact
- LCD status indication, set-up and programming
- Lock with a 4-digit PIN
- Back-light display
- Internal battery for set-up and programming without supply, easily replaceable from the front
- Protective separation between supply and contacts
- 35 mm wide
- 35 mm rail (EN 60715) mount
- Cadmium free contact material



- Digital time switch
- 1 CO 16 A

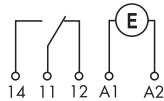

- Digital Astro-switch
- 1 CO 16 A

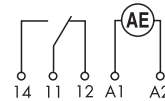

For outline drawing see page 15

**Contact specification**

Contact configuration		1 CO (SPDT)	1 CO (SPDT)
Rated current/Maximum peak current	A	16/30 (120 A - 5 ms)	16/30 (120 A - 5 ms)
Rated voltage/Maximum switching voltage	V AC	250/400	250/400
Rated load AC1	VA	4000	4000
Rated load AC15 (230 V AC)	VA	750	750
Nominal lamp rating:			
230 V incandescent/halogen W		2000	2000
fluorescent tubes with electronic ballast W		1000	1000
fluorescent tubes with electromagnetic ballast W		750	750
CFL W		400	400
230 V LED W		400	400
LV halogen or LED with electronic ballast W		400	400
LV halogen or LED with electromagnetic ballast W		800	800
Minimum switching load	mW (V/mA)	1000 (10/10)	1000 (10/10)
Standard contact material		AgSnO <sub>2</sub>	AgSnO <sub>2</sub>

**Supply specification**

Nominal voltage (U <sub>N</sub> )	V AC (50/60 Hz)	110...230	110...230
	V DC	110...230	110...230
Rated power AC/DC	VA (50 Hz)/W	2.8/0.9	2.8/0.9
Operating range	V AC (50 Hz)	88...264	88...264
	V DC	88...264	88...264

**Technical data**

Electrical life at rated load in AC1	cycles	100 · 10 <sup>3</sup>	100 · 10 <sup>3</sup>
Switching intervals		48	—
Minimum switching interval	min	30	—
Accuracy	s/day	1	1
Communication protocol		NFC	NFC
Ambient temperature range	°C	-20...+50 (see page 10, diagram L12)	-20...+50 (see page 10, diagram L12)
Protection category		IP 20	IP 20

**Approvals (according to type)**



**Digital time switch, weekly programming**  
- Can be programmed in "Classic" mode via the joystick, or "Smart" mode via smartphones with NFC communication

**Type 12.61**

- 1 CO 16 A

**Type 12.62**

- 2 CO 16 A

• Functions:

Switch ON, Switch OFF

Pulse: 1s...59 min

- Minimum time interval setting - 1 minute
- Summer/Winter European, Australian, Brazilian time
- LCD status indication, set-up and programming
- Lock with a 4-digit PIN
- Back-light display
- Internal battery for set-up and programming without supply, easily replaceable from the front
- Protective separation between supply and contacts
- 35 mm wide
- 35 mm rail (EN 60715) mount
- Cadmium free contact material

For outline drawing see page 16

**Contact specification**

Contact configuration		1 CO (SPDT)	2 CO (DPDT)
Rated current/Maximum peak current	A	16/30 (120 A - 5 ms)	16/30 (120 A - 5 ms)
Rated voltage/Maximum switching voltage	V AC	250/400	250/400
Rated load AC1	VA	4000	4000
Rated load AC15 (230 V AC)	VA	750	750
Nominal lamp rating:			
230 V incandescent/halogen W		2000	2000
fluorescent tubes with electronic ballast W		1000	1000
fluorescent tubes with electromagnetic ballast W		750	750
CFL W		400	400
230 V LED W		400	400
LV halogen or LED with electronic ballast W		400	400
LV halogen or LED with electromagnetic ballast W		800	800
Minimum switching load	mW (V/mA)	1000 (10/10)	1000 (10/10)
Standard contact material		AgSnO <sub>2</sub>	AgSnO <sub>2</sub>

**Supply specification**

Nominal voltage (U <sub>N</sub> )	V AC (50/60 Hz)	12...24	110...230	110...230
	V DC	12...24	110...230	110...230
Rated power AC/DC	VA (50 Hz)/W	2.8/0.9		2.8/0.9
Operating range	V AC (50 Hz)	10...30	88...253	88...253
	V DC	10...30	88...253	88...253

**Technical data**

Electrical life at rated load in AC1	cycles	100 · 10 <sup>3</sup>	100 · 10 <sup>3</sup>
Type of time switch		Weekly	Weekly
Memory locations for switching times		50	50
Minimum internal setting	min	1	1
Accuracy	s/day	1	1
Communication protocol		NFC	NFC
Ambient temperature range	°C	-20...+50 (see page 10, diagram L12)	-20...+50 (see page 10, diagram L12)
Protection category		IP 20	IP 20

**Approvals** (according to type)



- Weekly programming
- 1 CO 16 A
- Switch ON, Switch OFF, Pulse

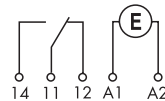

- Weekly programming
- 2 CO 16 A
- Switch ON, Switch OFF, Pulse

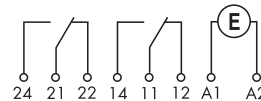

**Weekly Astro time switch**  
 - Can be programmed in "Classic" mode via the joystick, or "Smart" mode via smartphones with NFC communication  
 - "Astro" program: calculation of sunrise and sunset times through date, time and location coordinates

**Type 12.A1**  
 - 1 CO 16 A

**Type 12.A2**  
 - 2 CO 16 A

**Type 12.B2**  
 - 2 CO 16 A

- Functions: "Astro" ON, "Astro" OFF, Switch ON, Switch OFF, Pulse: 1s...59 min
- Location coordinates easily settable for most European countries through Post codes
- Offset function: allows programming of switching times offset from the astronomic time (by up to 90 min, in 1 min step)
- Minimum time interval setting - 1 minute
- Summer/Winter European, Australian, Brazilian time
- LCD status indication, set-up and programming
- Lock with a 4-digit PIN
- Back-light display
- Internal battery for set-up and programming without supply, easily replaceable from the front
- Protective separation between supply and contacts
- 35 mm wide
- 35 mm rail (EN 60715) mount
- Cadmium free contact material

For outline drawing see page 15, 16

**Contact specification**

Contact configuration	1 CO (SPDT)	2 CO (DPDT)	2 CO (DPDT)
Rated current/Maximum peak current	A 16/30 (120 A - 5 ms)	16/30 (120 A - 5 ms)	16/30 (120 A - 5 ms)
Rated voltage/Maximum switching voltage	V AC 250/400	250/400	250/400
Rated load AC1	VA 4000	4000	4000
Rated load AC15 (230 V AC)	VA 750	750	750
Nominal lamp rating:			
230 V incandescent/halogen W	2000	2000	2000
fluorescent tubes with electronic ballast W	1000	1000	1000
fluorescent tubes with electromagnetic ballast W	750	750	750
CFL W	400	400	400
230 V LED W	400	400	400
LV halogen or LED with electronic ballast W	400	400	400
LV halogen or LED with electromagnetic ballast W	800	800	800
Minimum switching load	mW (V/mA) 1000 (10/10)	1000 (10/10)	1000 (10/10)
Standard contact material	AgSnO <sub>2</sub>	AgSnO <sub>2</sub>	AgSnO <sub>2</sub>

**Supply specification**

Nominal voltage (U <sub>N</sub> )	V AC (50/60 Hz)	110...230	12...24	110...230	110...230
	V DC	110...230	12...24	110...230	110...230
Rated power AC/DC	VA (50 Hz)/W	2.8/0.9	2.8/0.9	2.8/0.9	2.8/0.9
Operating range	V AC (50 Hz)	88...253	10...30	88...253	88...253
	V DC	88...253	10...30	88...253	88...253

**Technical data**

Electrical life at rated load in AC1	cycles	100 · 10 <sup>3</sup>	100 · 10 <sup>3</sup>	100 · 10 <sup>3</sup>
Type of time switch		Weekly	Weekly	Yearly
Memory locations for switching times		50	50	100
Minimum internal setting	min	1	1	1
Accuracy	s/day	1	1	1
Communication protocol		NFC	NFC	Bluetooth 5, NFC
Ambient temperature range	°C	-20...+50 (see page 10, diagram L12)	-20...+50 (see page 10, diagram L12)	-20...+50 (see page 10, diagram L12)
Protection category		IP 20	IP 20	IP 20

**Approvals** (according to type)



**12.A1**

- Weekly programming
- 1 CO 16 A
- Switch ON, Switch OFF, Pulse

**12.A2**

- Weekly programming
- 2 CO 16 A
- Switch ON, Switch OFF, Pulse

**NEW 12.B2**

- Yearly programming
- 2 CO 16 A
- Switch ON, Switch OFF, Pulse, Astro ON, Astro OFF, Astro Pulse

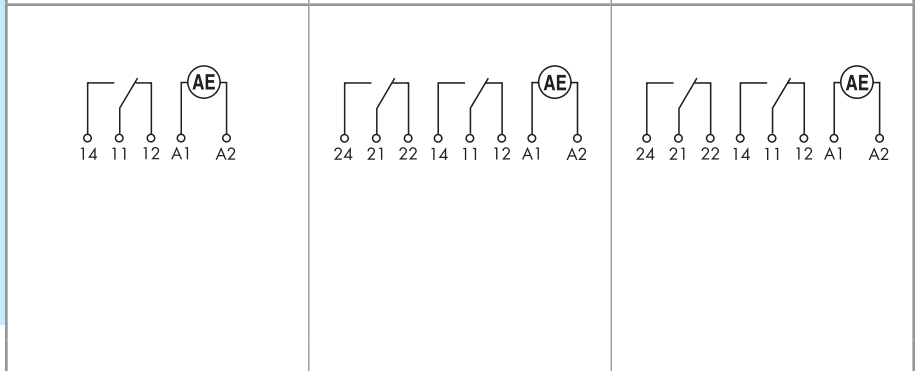

**Weekly Astro time switch**

- Suitable for applications where a variable light level is required - programmable via smartphone with NFC communications
- Compatible with power supply/ballasts with 0-10V or PWM inputs

**Type 12.A4**

- 1 analog output: 0-10V or PWM
- Functions: "Astro" ON, "Astro" OFF, ON/OFF
- Location coordinates easily settable for most European countries through Post codes
- Offset function: allows programming of switching times offset from the astronomic time (by up to 90 min, in 1 min step)
- Minimum time interval setting - 1 minute
- 50 storable programs
- Summer/Winter European, Australian, Brazilian time
- LCD status indication, set-up and programming
- Lock with a 4-digit PIN
- Back-light display
- Internal battery for set-up and programming without supply, easily replaceable from the front
- Protective separation between supply and contacts
- 35 mm wide
- 35 mm rail (EN 60715) mount
- Cadmium free contact material

**NEW 12.A4**



- Weekly programming
- 1 analog output: 0-10V or PWM



For outline drawing see page 16

**Analogue output characteristics**

Output signal	0-10 V, 10mA max
Output signal	PWM 30 V, 20 mA max

**Contact output characteristics**

Contact configuration	1 CO (SPST)
Rated current/Maximum peak current	A 16/30 (120 A - 5 ms)
Rated voltage/Maximum switching voltage	V AC 250/400
Rated load AC1	VA 4000
Rated load AC15 (230 V AC)	VA 750
Minimum switching load	mW (V/mA) 1000 (10/10)
Standard contact material	AgSnO <sub>2</sub>

**Supply specification**

Nominal voltage (U <sub>N</sub> )	V AC (50/60 Hz)	110...230
	V DC	110...230
Rated power AC/DC	VA (50 Hz)/W	2.8/0.9
Operating range	V AC (50 Hz)	90...264
	V DC	90...264

**Technical data**

Type of time switch	Weekly
Memory locations for switching times	50
Minimum switching interval	min 1
Accuracy	s/day 1
Communication protocol	NFC
Ambient temperature range	°C -20...+50
Protection category	IP 20

**Approvals** (according to type)



**Electronic digital time switches****- 1 Weekly time setting****Type 12.71**

- 1 CO 16 A
- 17.8 mm wide
- Minimum time interval setting - 1 minute
- Internal battery for set-up without supply
- Pulse output function:  
1 s...59:59(mm:ss)
- Automatic adjustment for daylight saving
- 35 mm rail (EN 60715) mount

**12.71**

- Digital weekly time switch
- 1 CO 16 A
- 17.8 mm wide

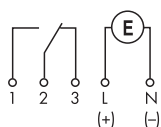

For outline drawing see page 15

**Contact specification**

Contact configuration	1 CO (SPDT)	
Rated current/Maximum peak current	A	16/30
Rated voltage/ Maximum switching voltage	V AC	250/—
Rated load AC1	VA	4000
Rated load AC15 (230 V AC)	VA	420
Nominal lamp rating:		
230 V incandescent/halogen W	400	
fluorescent tubes with electronic ballast W	100	
fluorescent tubes with electromagnetic ballast W	100	
CFL W	50	
230 V LED W	50	
LV halogen or LED with electronic ballast W	50	
LV halogen or LED with electromagnetic ballast W	100	
Minimum switching load	mW (V/mA)	1000 (10/10)
Standard contact material	AgNi	

**Supply specification**

Nominal voltage (U <sub>N</sub> )	V AC (50/60 Hz)	—	230
	V AC/DC	24	—
Rated power AC/DC	VA (50 Hz)/W	1.4/1.4	2/—
Operating range	AC (50 Hz)	(0.9...1.1)U <sub>N</sub>	(0.85...1.1)U <sub>N</sub>
	DC	(0.9...1.1)U <sub>N</sub>	—

**Technical data**

Electrical life at rated load in AC1	cycles	50 · 10 <sup>3</sup>
Type of time switch	weekly	
Memory locations for switching times*	30	
Minimum switching interval	min	1
Accuracy	s/day	0.5
Ambient temperature range	°C	-30...+55
Protection category	IP 20	

**Approvals (according to type)**

\* Switching times in memory may be used more than once i.e. when selected for different days.

## Ordering information

Example: 12 series digital (analogue style) time switch, 1 CO 16 A contact, (110...230)V AC/DC supply

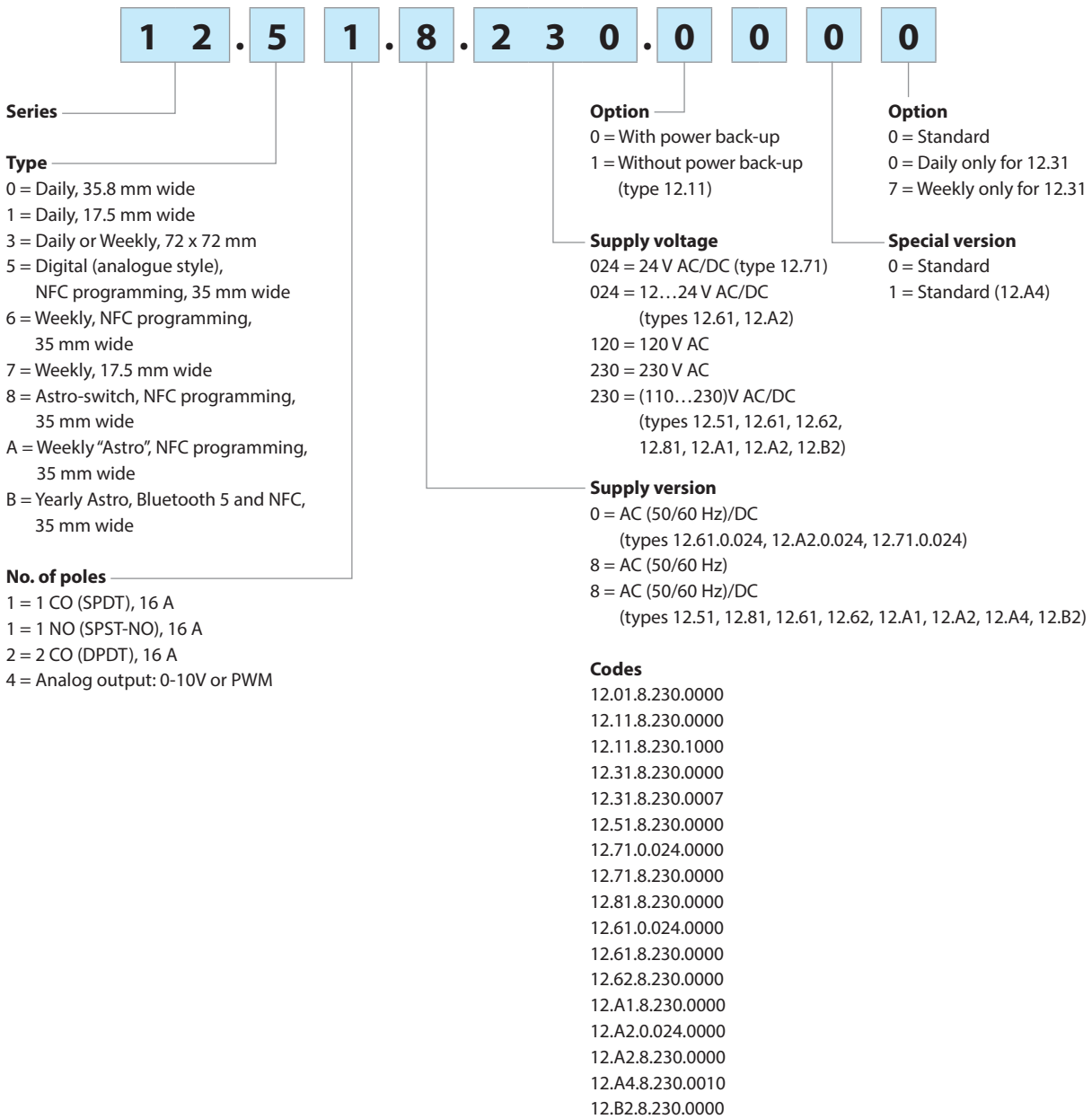



## Technical data

Insulation		12.51, 12.61, 12.62, 12.81, 12.A1, 12.A2, 12.A4, 12.B2	12.01, 12.11, 12.31, 12.71		
Dielectric strength between supply and contacts	V AC	4000	4000		
Dielectric strength between open contacts	V AC	1000	1000		
Rated impulse voltage (between supply and contacts)	kV/(1.2/50) $\mu$ s	6	6		
Rated impulse voltage (between open contacts)	kV/(1.2/50) $\mu$ s	1.5	1.5		
EMC specifications					
Type of test		Reference standard			
Electrostatic discharge	contact discharge	EN 61000-4-2	4 kV	6 kV	
	air discharge	EN 61000-4-2	8 kV	8 kV	
Radiated electromagnetic field (80...1000 MHz)		EN 61000-4-3	10 V/m	10 V/m	
Fast transients (burst 5/50 ns, 5 and 100 kHz)		EN 61000-4-4	4 kV	4 kV	
Voltage pulses on supply terminals (surge 1.2/50 $\mu$ s)	common mode	EN 61000-4-5	4 kV	2 kV	
	differential mode	EN 61000-4-5	4 kV	2 kV	
Radiofrequency common mode voltage (0.15...80 MHz)		EN 61000-4-6	10 V	10 V	
Voltage dips	70% $U_N$ , 40% $U_N$	EN 61000-4-11	10 cycles	10 cycles	
Short interruptions		EN 61000-4-11	10 cycles	10 cycles	
Radio frequency conducted emissions	0.15...30 MHz	EN 55014	class B	class B	
Radiated emissions		30...1000 MHz	EN 55014	class B	
Radiated emissions		30...1000 MHz	EN 55014	class B	
Terminals					
 Screw torque	Nm	0.8	1.2		
Max. wire size		mm <sup>2</sup>	AWG	mm <sup>2</sup>	AWG
	solid cable	1 x 6 / 2 x 4	1 x 10 / 2 x 12	1 x 6 / 2 x 4	1 x 10 / 2 x 12
	stranded cable	1 x 4 / 2 x 2.5	1 x 12 / 2 x 14	1 x 6 / 2 x 2.5	1 x 10 / 2 x 14
Wire strip length	mm	9			
Other data					
Power back-up (Battery life)		6 years (12.51, 12.61, 12.62, 12.81, 12.A1, 12.A2, 12.A4, 12.71, 12.B2)			
Battery type		CR 2032, 3 V, 230 mAh (12.51, 12.61, 12.62, 12.81, 12.A1, 12.A2, 12.A4, 12.B2)			
Power back-up		100 h (12.01, 12.11, 12.31 - following 80 h continuous energisation)			
Power lost to the environment		12.51, 12.61, 12.81, 12.A1	12.62, 12.A2, 12.A4, 12.B2	12.01, 12.11, 12.31	12.71
	in stand-by W	0.2	0.2	—	—
	without contact current W	0.9	0.9	1.5	2
	with rated current W	1.5	2.1	2.5	3 (for 1 pole)

### L 12 - Rated current v ambient temperature

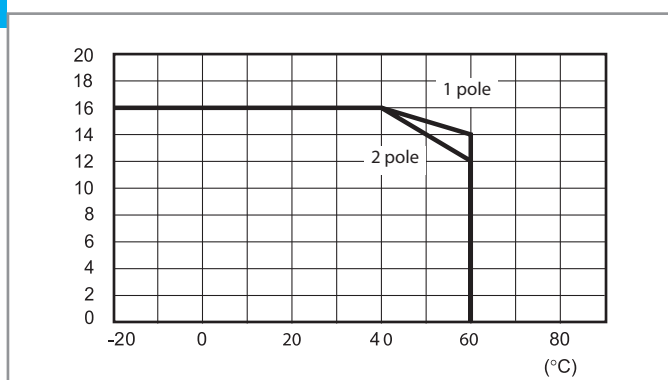



Wiring diagrams

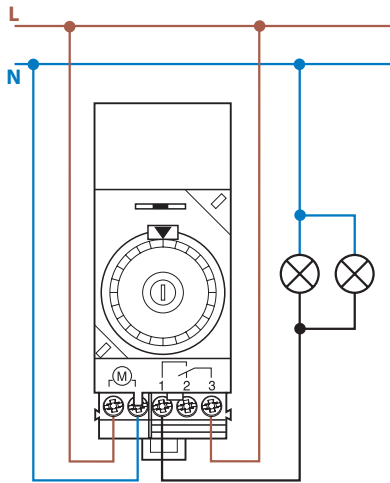

**Type 12.01**

Selector switch:

- ⊖ = Permanently OFF
- AUTO = Automatic
- I = Permanently ON

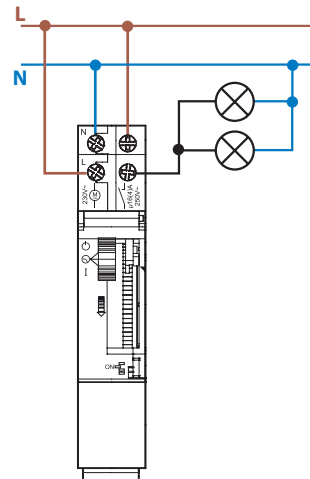

**Type 12.11**

Selector switch:

- ⊖ = Permanently OFF
- ⊕ = Automatic
- I = Permanently ON

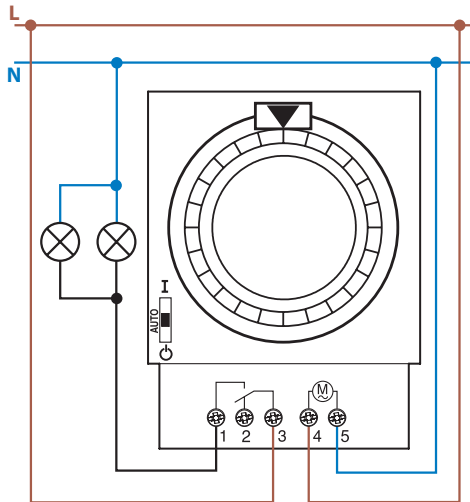

**Type 12.31**

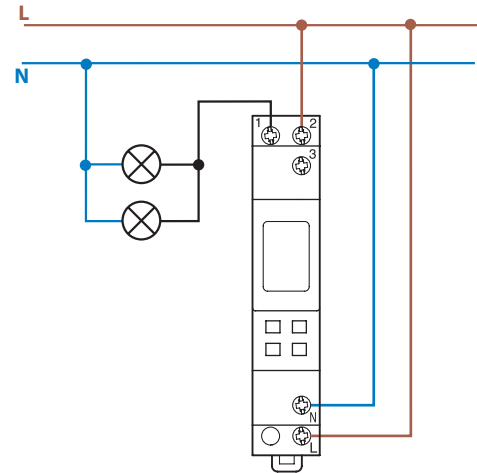

**Type 12.71**

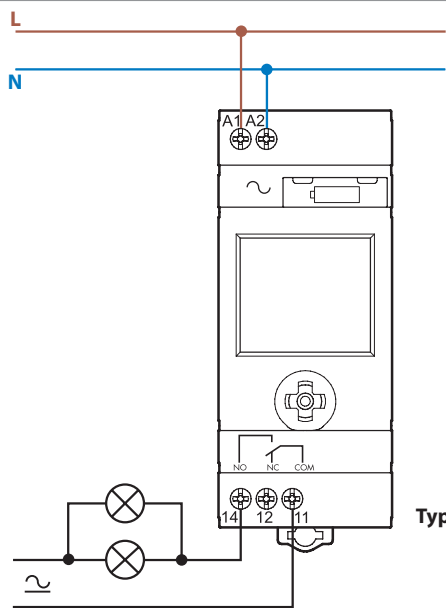

**Types 12.51  
12.81**

Wiring diagrams

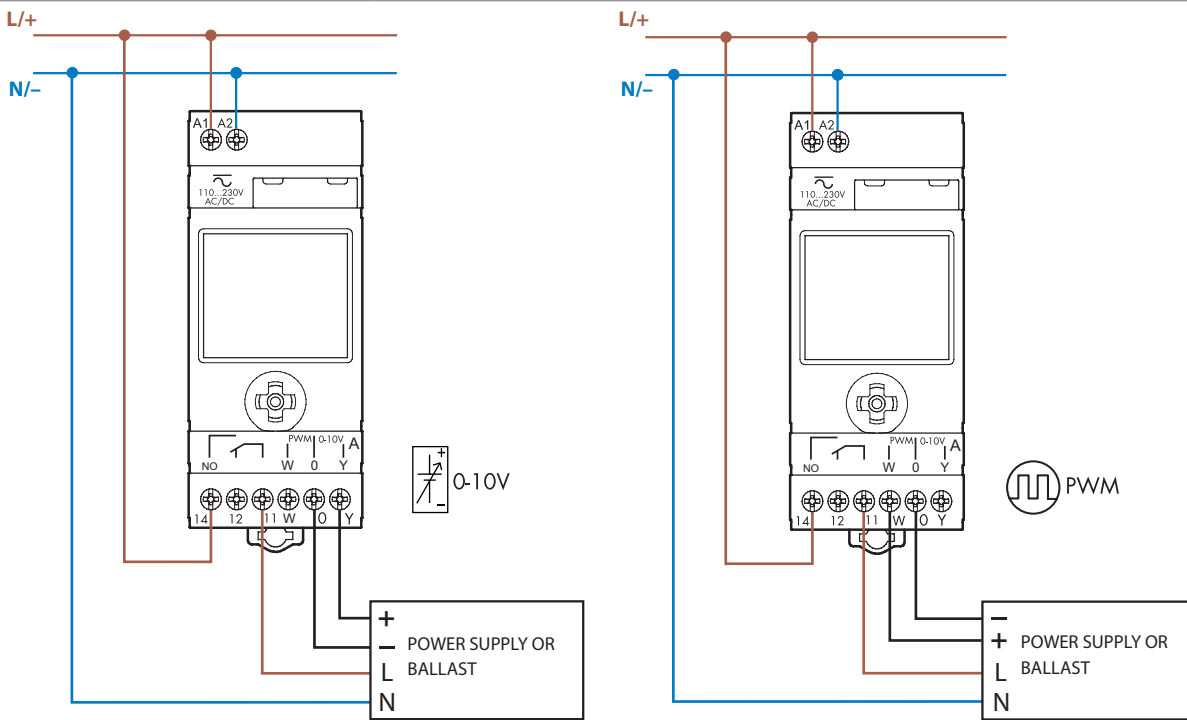
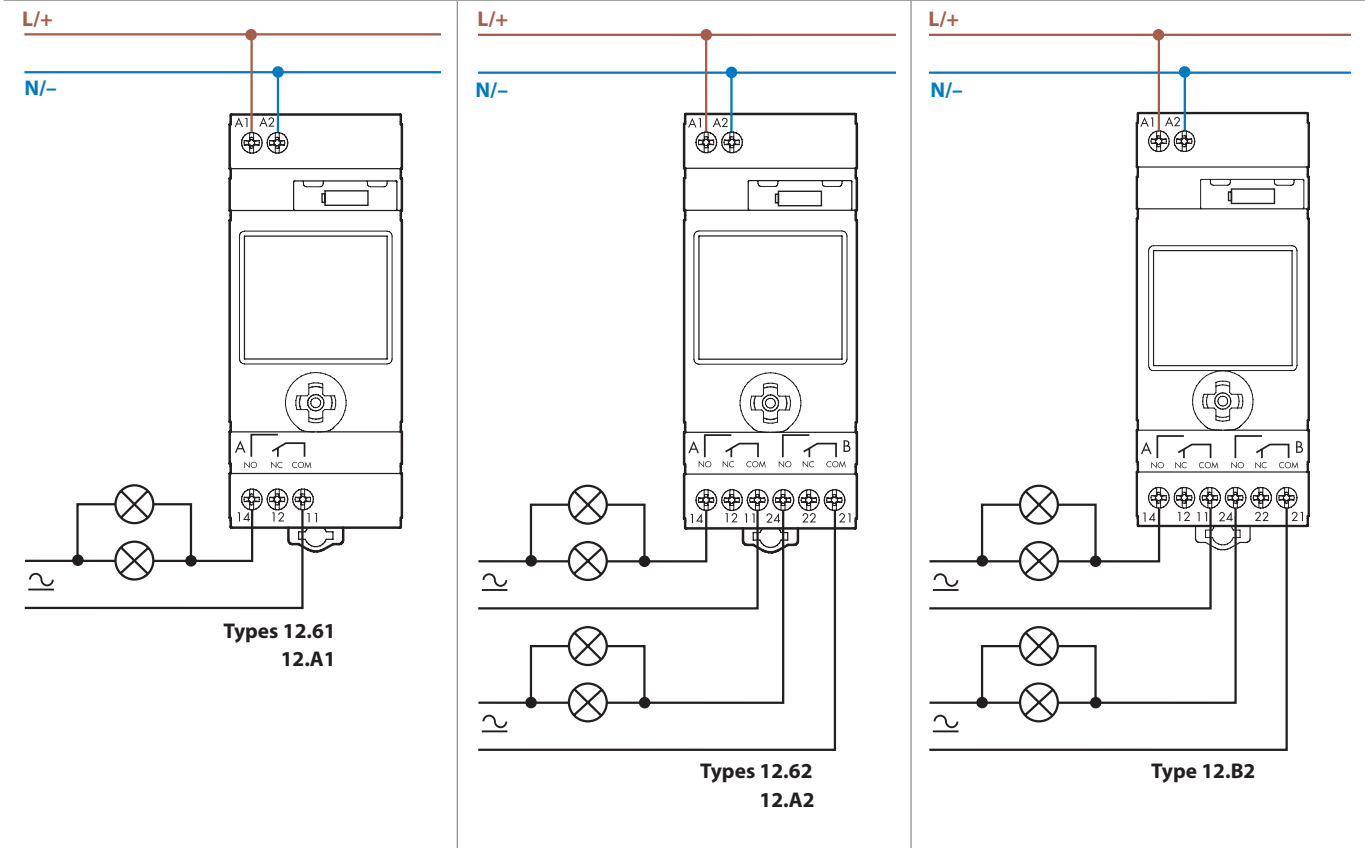

### Wiring diagrams

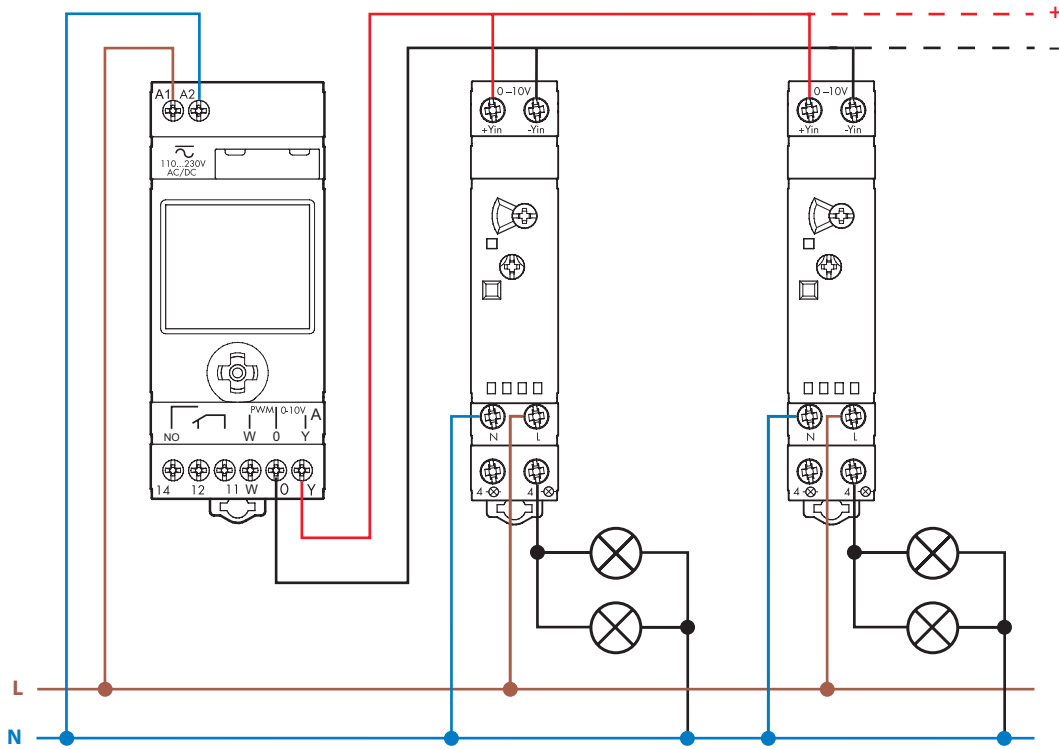

**Type 12.A4 with 15.11**  
Application example with slave dimmer Type 15.11

### Expandability

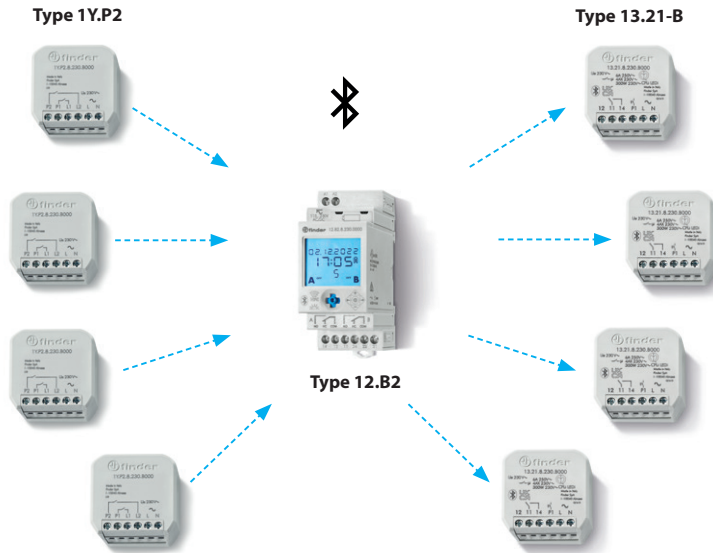

Using the maximum number of expansions, you can make up to 6 outputs and 8 inputs out of it



In this application you can use a range extender (Type 1Y.E8) to reach the most distant devices.

Different programming modes for type 12.51, 12.61, 12.62, 12.81, 12.A1, 12.A2, 12.A4, 12.B2

“Smart”

Mode via smartphones with NFC communication using Finder toolbox Android App.



“Classic”

Mode via the joystick

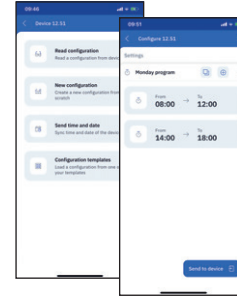
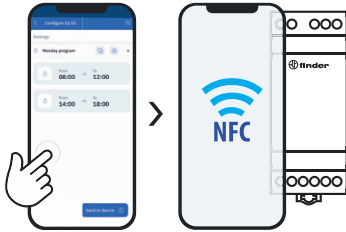

Bluetooth programming (Type 12.B2 only)

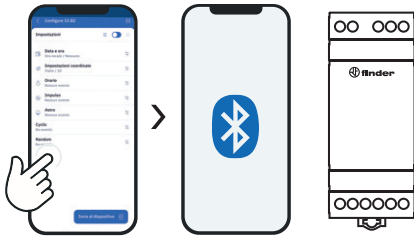

Finder Toolbox for programming

Once the App FINDER Toolbox is downloaded and installed, you can read an existing program, or program your device with maximum flexibility, changing the smallest details and saving your program directly to your smartphone. At this point you simply touch the time switch with the smartphone to transfer the data.

Finder Toolbox for reference

Finder Toolbox provides all technical data sheets and news from Finder Toolbox.

J Functions type 12.81

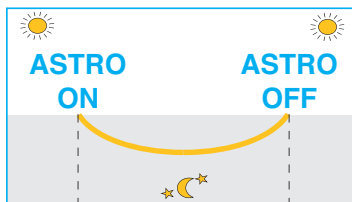

The Override feature permits the 12.81 three different ways of functioning:

- 1 Classic function where the **AstroON** and **AstroOFF** times are determined by the geographic coordinates. These times vary every day.
- 2 Functions such that the output turns on according to the **AstroON** time and turns off according to the clock off-time  $\text{OFF}$ . Application example: shop window lighting on by **AstroON** at sunset and off  $\text{OFF}$  at 00:30.
- 3 Functions such that the output turns on according to the **AstroON** time and turns off according to the clock off-time  $\text{OFF}$ , and then turns back on at the clock on-time  $\text{ON}$  (for the remainder of the ASTRO time period). Application example: company car park lighting, on by **AstroON** at sunset, off end of the evening shift at 23:00  $\text{OFF}$ . On again at the beginning of the morning shift at 5:00  $\text{ON}$  and off automatically by **AstroOFF**.\*

\* Depending on the time of year (summer specifically) it may be that the override ON time will fall after the AstroOFF time. In this case, the output switches off at the AstroOFF time and the override ON time is ignored.

Outline drawings

Type 12.01  
Screw terminal

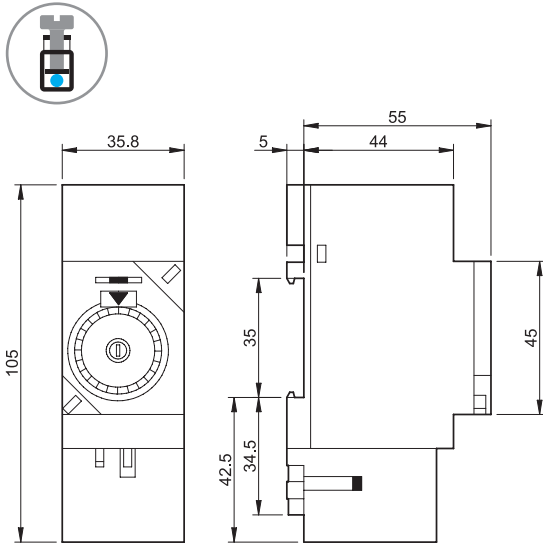

Type 12.11  
Screw terminal

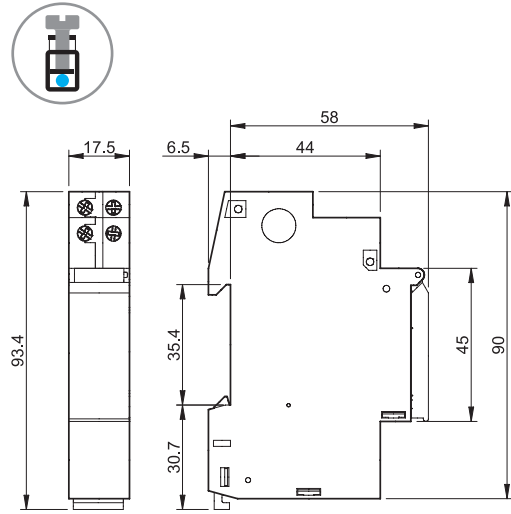

Type 12.31  
Screw terminal

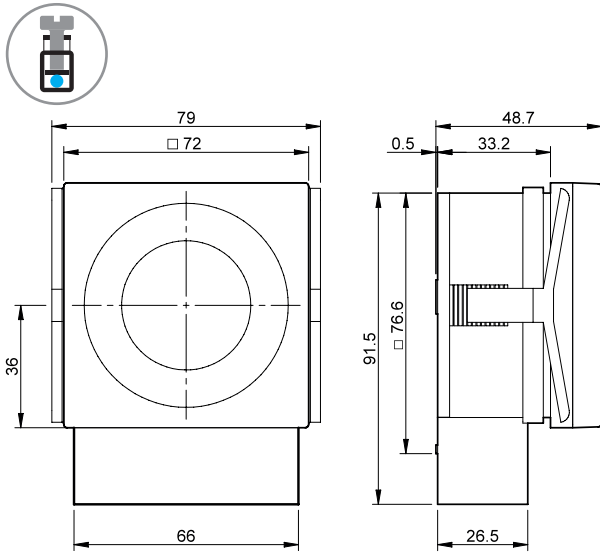

Types 12.51/12.81  
Screw terminal

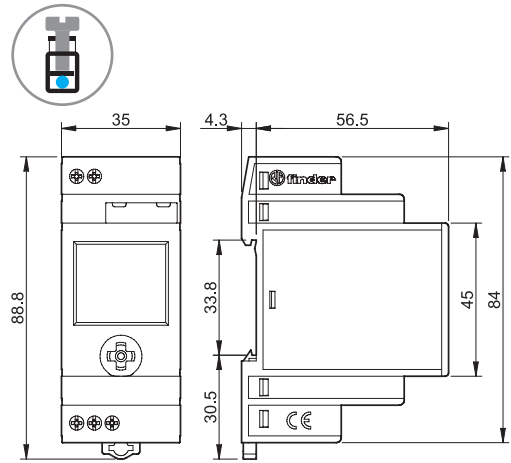

Type 12.71  
Screw terminal

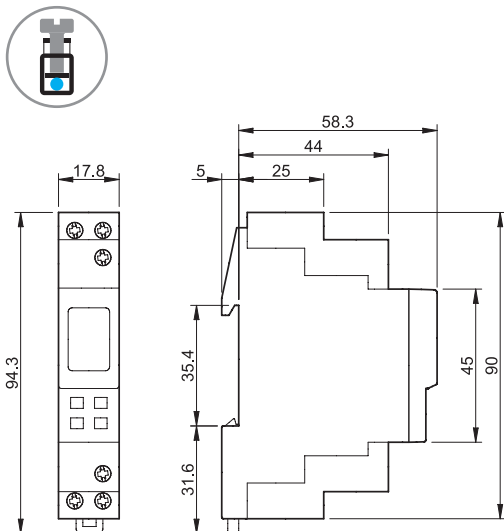

Types 12.61 / 12.A1  
Screw terminal

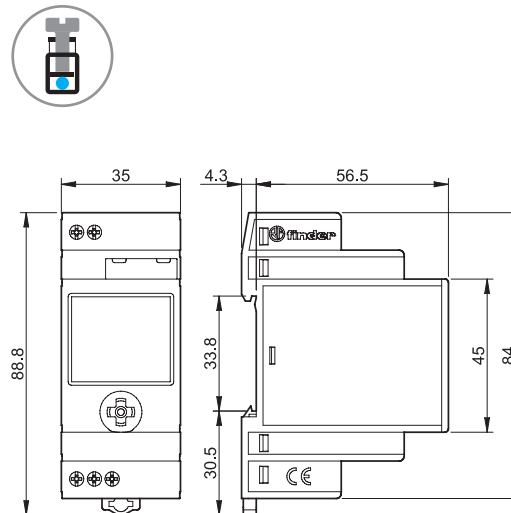

## Outline drawings

Types 12.62 / 12.A2 / 12.A4  
Screw terminal

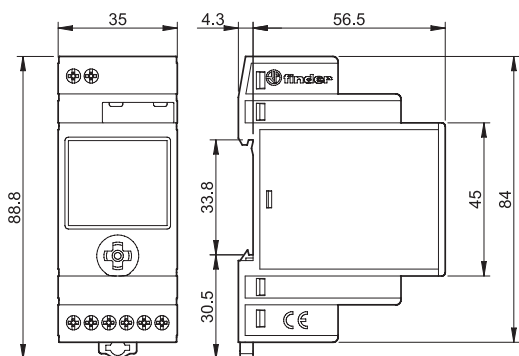

Type 12.B2  
Screw terminal

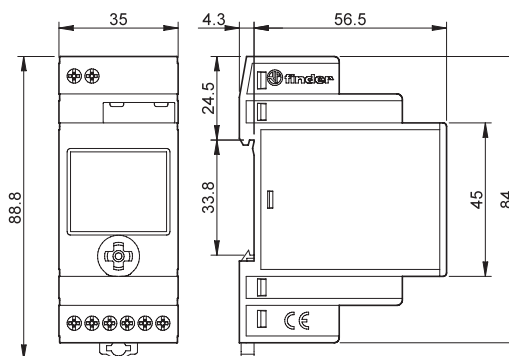

## Battery replacement type 12.51, 12.61, 12.62, 12.81, 12.A1, 12.A2, 12.A4, 12.B2

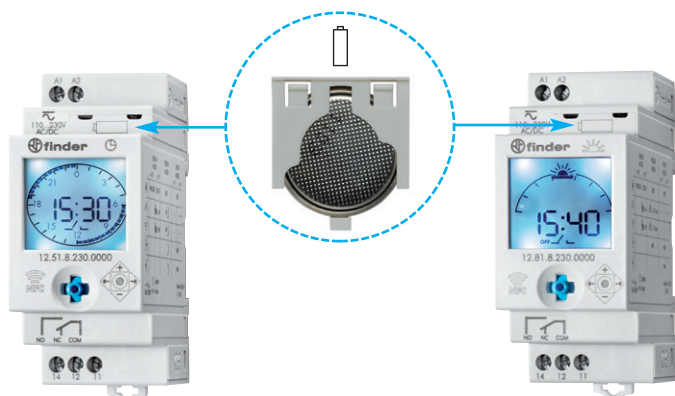

### Power-save mode

If the 230 V AC supply is not connected, the time switch enters power-save mode: only the clock is maintained active whilst the display turns off so as to guarantee a long life for the built-in back-up battery. With a press to the joystick it is possible to "awake" the device and enter Display mode (with the "plug" symbol displayed). A further press to  will enter the program or set-up mode as explained in the Display mode section above.

After about 1 minute of inactivity the power-save mode will start again. During program or set-up the current absorption is higher than in power-save mode, thus influencing the battery life.

In this mode the display back-light is not active. It is activated following a press to the joystick only with the 230 V AC supply connected, but after about 1 minute of inactivity the display back-light will turn off, and to activate it again it is necessary to press the joystick again.

Note: the output relay only functions if the power supply is connected.

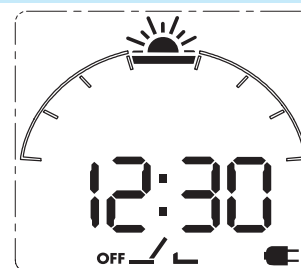

Accessories type 12.51, 12.61, 12.62, 12.81, 12.A1, 12.A2, 12.A4, 12.B2



011.01

Adaptor for panel mounting, 35 mm wide

011.01

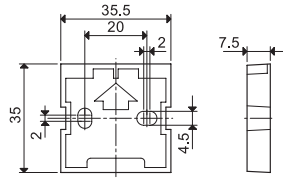

012.BG.8.230

GPS external antenna, this device synchronizes the 12.B2s time and date via Bluetooth

012.BG.8.230

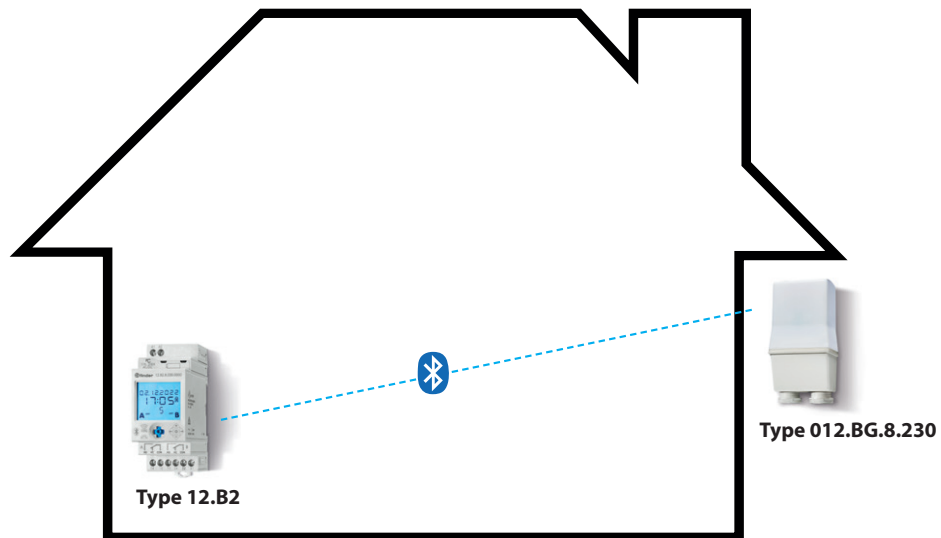
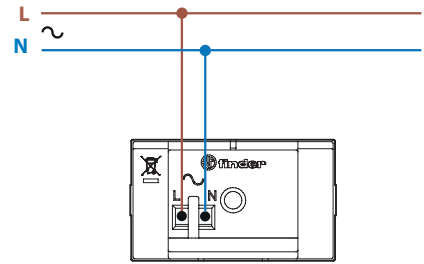
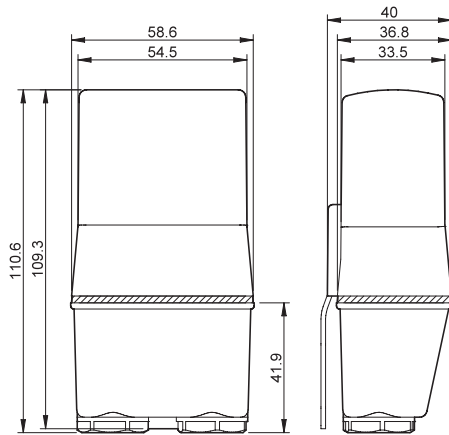

- The 12.B2 is designed to be installed in a cabinet, while the external antenna takes care of the constant time synchronization.
- There is no limit of 12.B2 for a single antenna, the only important parameter is the range of action of the Bluetooth.
- Install the antenna outside, close to a window or the external wall.





# Electronic staircase timers 16 A



Staircase  
light control



14  
SERIES



**Multi-function electronic staircase timers  
1 NO 16 A 17.5 mm wide**

**Type 14.01**

- 8 functions
- Switch-off "early warning" options

**Type 14.11**

- 4 functions
- Terminal for reset (centralised switch off)

**Type 14.71**

- 3 functions

- Time setting from 30 seconds to 20 minutes
- "Zero crossing" load switching
- Suitable for 3 or 4 wire systems, with automatic recognition
- Compatible with movement detectors (18 series)
- LED status indicators
- Cadmium free contact material
- Can be used with illuminated push - buttons
- "Blade + cross" - both flat blade and cross head screw drivers can be used to adjust the function selector, the timing trimmer, and to disengage the 35 mm rail mounting clip
- 35 mm rail (EN 60715) mount

14.01/11/71  
Screw terminal



For outline drawing see page 11

**Contact specification**

Contact configuration	1 NO (SPST-NO)	1 NO (SPST-NO)	1 NO (SPST-NO)	
Rated current/Maximum peak current	A	16/30 (120 A - 5 ms)	16/30 (120 A - 5 ms)	16/30 (120 A - 5 ms)
Rated voltage/ Maximum switching voltage	V AC	230/—	250/400	230/—
Rated load AC1	VA	3700	4000	3700
Rated load AC15 (230 V AC)	VA	750	750	750
Nominal lamp rating:				
230 V incandescent/halogen W		3000	3000	3000
fluorescent tubes with electronic ballast W		1500	1500	1500
fluorescent tubes with electromagnetic ballast W		1000	1000	1000
CFL W		600	600	600
230 V LED W		600	600	600
LV halogen or LED with electronic ballast W		600	600	600
LV halogen or LED with electromagnetic ballast W		1500	1500	1500
Minimum switching load	mW (V/mA)	1000 (10/10)	1000 (10/10)	1000 (10/10)
Standard contact material		AgSnO <sub>2</sub>	AgSnO <sub>2</sub>	AgSnO <sub>2</sub>

**Supply specification**

Nominal voltage (U <sub>N</sub> )	V AC (50/60 Hz)	230	110...240	230
	V DC	—	—	—
Rated power	VA (50 Hz)/W	3/1.2	3.2/1	3/1.2
Operating range	AC (50 Hz)	(0.8...1.1)U <sub>N</sub>	(90...264)U <sub>N</sub>	(0.8...1.1)U <sub>N</sub>
	DC	—	—	—
Reset time (s)		—	3	—

**Technical data**

Electrical life at rated load in AC1	cycles	100 · 10 <sup>3</sup>	100 · 10 <sup>3</sup>	100 · 10 <sup>3</sup>
Delay setting	min	0.5...20	0.5...20	0.5...20
Max no. of illuminated push-button (≤ 1 mA)		30	45	30
Maximum impulse duration		continuous	continuous	continuous
Dielectric strength between:				
open contacts V AC		1000	1000	1000
supply - contacts V AC		—	2000	—
Ambient temperature range	°C	-10...+60	-10...+60	-10...+60
Protection category		IP 20	IP 20	IP 20

**Approvals (according to type)**



**14.01**



- 8 functions:
  - Staircase timer
  - Staircase timer + maintenance function
  - Staircase timer with early warning
  - Staircase timer with early warning + maintenance function
  - Timing step relay
  - Timing step relay with early warning
  - Step relay
  - Light ON

**NEW 14.11**



- Reset for centralised switch off
- 4 functions:
  - Step relay
  - Timing Step relay
  - Staircase timer
  - Light ON

**14.71**



- 3 functions:
  - Staircase timer
  - Staircase timer + maintenance function
  - Light ON

**Mono-function electronic staircase timers  
1 NO 16 A 17.5 mm wide**
**Type 14.81**

- Staircase timer + maintenance function

**Type 14.91**

- Signal ON pulse timer

- Time setting from 30 seconds to 20 minutes
- "Zero crossing" load switching
- Wiring compatible with mechanical versions and with old type (low emission) illuminated pushbuttons
- Suitable for 3 or 4 wire systems, via "pushbutton configuration"
- 110...125 V AC supply version available (14.81)
- Cadmium free contact material
- Can be used with illuminated push - buttons
- "Blade + cross" - both flat blade and cross head screw drivers can be used to adjust the function selector, the timing trimmer, and to disengage the 35 mm rail mounting clip
- 35 mm rail (EN 60715) mount

14.81/91

Screw terminal



For outline drawing see page 11

**Contact specification**

Contact configuration		14.81	14.91
Contact configuration		1 NO (SPST-NO)	1 NO (SPST-NO)
Rated current/Maximum peak current	A	16/30 (120 A - 5 ms)	16/30 (120 A - 5 ms)
Rated voltage/ Maximum switching voltage	V AC	230/—	230/—
Rated load AC1	VA	3700	3700
Rated load AC15 (230 V AC)	VA	750	750
Nominal lamp rating:			
230 V incandescent/halogen W		3000	3000
fluorescent tubes with electronic ballast W		1500	1500
fluorescent tubes with electromagnetic ballast W		1000	1000
CFL W		600	600
230 V LED W		600	600
LV halogen or LED with electronic ballast W		600	600
LV halogen or LED with electromagnetic ballast W		1500	1500
Minimum switching load	mW (V/mA)	1000 (10/10)	1000 (10/10)
Standard contact material		AgSnO <sub>2</sub>	AgSnO <sub>2</sub>

**Supply specification**

Nominal voltage (U <sub>N</sub> )	V AC (50/60 Hz)	110...125/230	230
	V DC	—	—
Rated power	VA (50 Hz)/W	3/1.2	3/1.2
Operating range	AC (50 Hz)	(0.8...1.1)U <sub>N</sub>	(0.8...1.1)U <sub>N</sub>
	DC	—	—

**Technical data**

Electrical life at rated load in AC1	cycles	100 · 10 <sup>3</sup>	100 · 10 <sup>3</sup>
Delay setting	min	0.5...20	0.5...20
Max no. of illuminated push-button (≤ 1 mA)		45	25
Maximum impulse duration		continuous	continuous
Ambient temperature range	°C	-10...+60	-10...+60
Protection category		IP 20	IP 20

**Approvals (according to type)**

**14.81**

- Mono-function:
  - Staircase timer + maintenance function
- All 4 terminal on same side

**14.91**

- Mono-function:
  - Signal ON pulse timer
- All 3 terminal on same side

## Ordering information

Example: 14 series multi-function timer, 1 NO (SPDT-NO) 16 A contact, supply rated at 230 V AC.

<b>1</b>	<b>4</b>	<b>.0</b>	<b>1</b>	<b>.</b>	<b>8</b>	<b>.</b>	<b>2</b>	<b>3</b>	<b>0</b>	<b>.</b>	<b>0</b>	<b>0</b>	<b>0</b>	<b>0</b>
<b>Series</b>			<b>Type</b>			<b>Supply voltage</b>			<b>Supply version</b>			<b>Contact circuit</b>		
0 = 35 mm rail (EN 60715) mount, 8 functions			0 = 35 mm rail (EN 60715) mount, with reset, 4 functions			120 = 110...125 V AC (14.81 only)			8 = AC (50/60 Hz)			0 = Standard		
1 = 35 mm rail (EN 60715) mount, 3 functions			8 = 35 mm rail (EN 60715) mount, mono-function, all terminals on same side			230 = 230 V						3 = NO (SPST) - voltage free (14.11 only)		
7 = 35 mm rail (EN 60715) mount, 3 functions			9 = 35 mm rail (EN 60715) mount, mono-function, 3 terminals			<b>No. of poles</b>			1 = 1 NO (SPST-NO) 16 A contact					

## Technical data

Insulation			
Dielectric strength between open contacts	V AC	1000	
Other data			
Power lost to the environment			
without contact current	W	1.2	
with rated current	W	2	
Maximum cable length for push-button connection	m	200	
Screw torque	Nm	0.8	
Max. wire size		solid cable	stranded cable
	mm <sup>2</sup>	1 x 6 / 2 x 4	1 x 4 / 2 x 2.5
	AWG	1 x 10 / 2 x 12	1 x 12 / 2 x 14

## Zero crossing switching

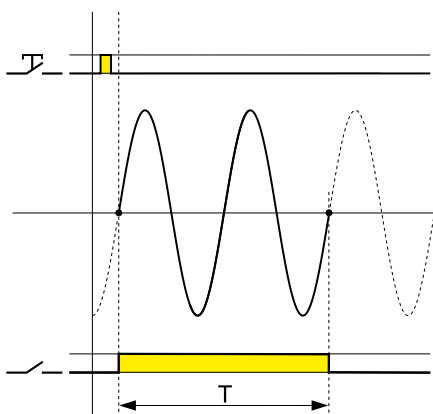

- 1 - Lower inrush current protects and increases lamp life
- 2 - Lower inrush current reduces the possibility of contact welding
- 3 - The current at switch-off is also lower, reducing stress and wear on the contacts

**Note**

Using the type 14.91, the lamps are switched on directly by the push-button

## Accessories



020.01

**Adaptor for panel mounting, 17.5 mm wide**

020.01

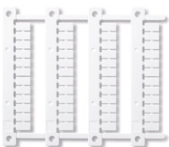

060.48

**Sheet of marker tags (CEMBRE Thermal transfer printers), plastic, 48 tags, 6 x 12 mm**

060.48

Wiring diagrams

**Type 14.01 / 14.71**

Red LED indication:  
Continuous = relay ON  
Blinking = relay OFF

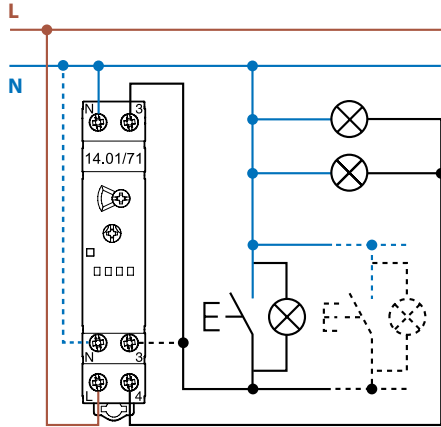

3 wire connection

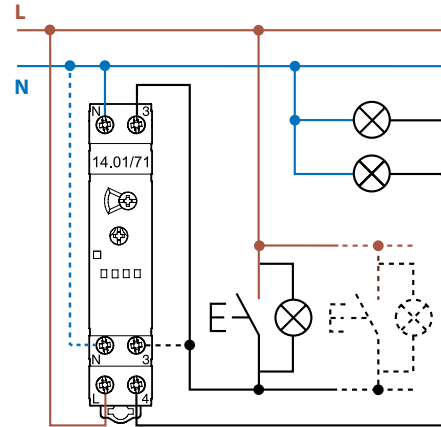

4 wire connection

**Type 14.81** (push-button configuration procedure, as per the Installation manual)

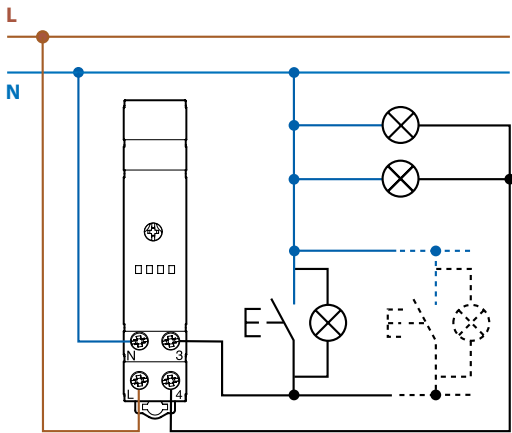

3 wire connection

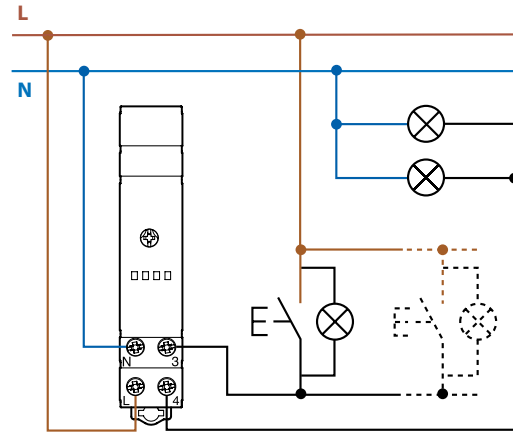

4 wire connection

**Type 14.91** (the push-buttons must be rated for the load current)

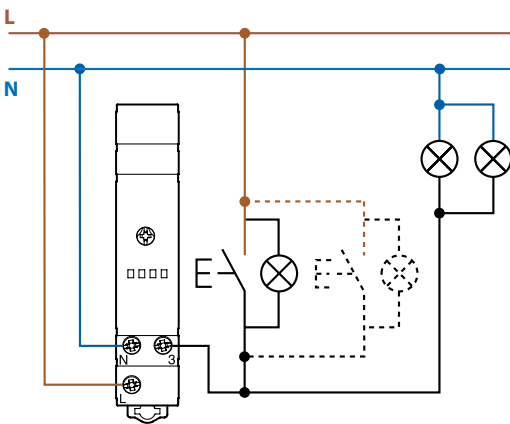

J

Wiring diagrams

**Type 14.11** Staircase light connection and load with the same phase

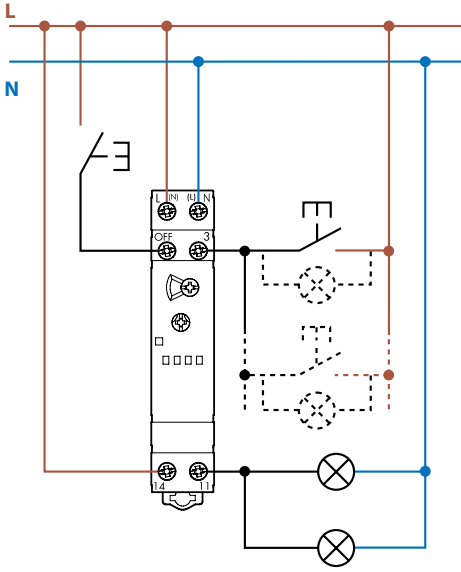

**Type 14.11** Staircase light connection and load with different phases

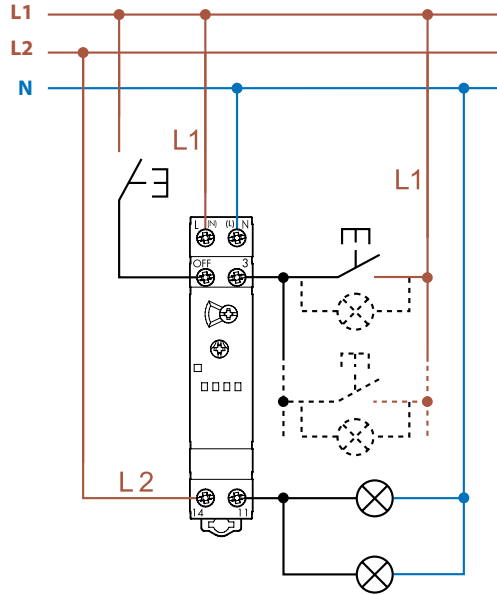

Note: If the load is powered by a phase other than the one that powers staircase light 14.11, a 50% reduction in the nominal lamp load must be applied.

14.01 or 14.71 without Staircase maintenance function, triggered by PIR movement detector (18 series).

**3 wire connection** (with 18.21.8.230.0300 or 18.31.8.230.0300 only)

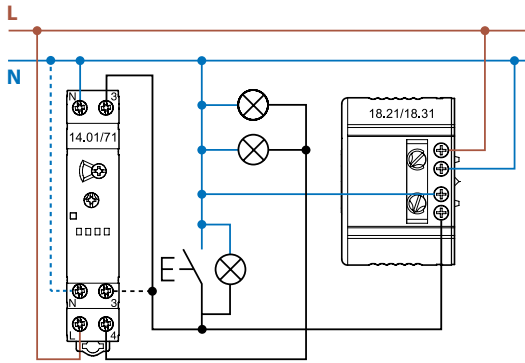

**4 wire connection** (with 18.21.8.230.0300 or 18.31.8.230.0300 only)

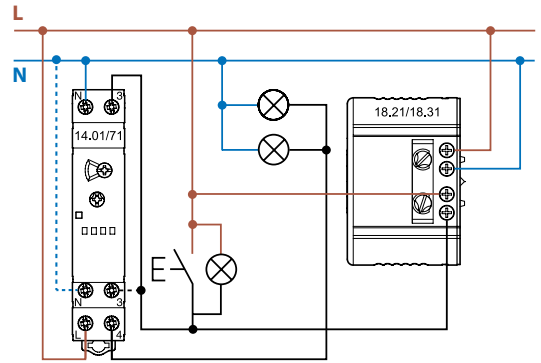

**4 wire connection** (with 18.01.8.230.0000 or 18.11.8.230.0000 only)

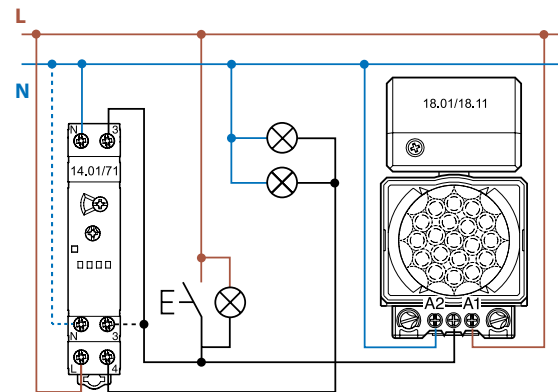

Functions

Type 14.01 Functions selectable with front rotary selector

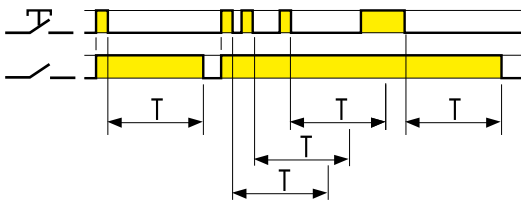

**(BE) Staircase timer**

On initial impulse the output contact closes and timing starts for the pre-set duration; subsequent impulses during the timing period will extend the timing period by the full pre-set value.  
On expiry of the time delay, the output contact opens.

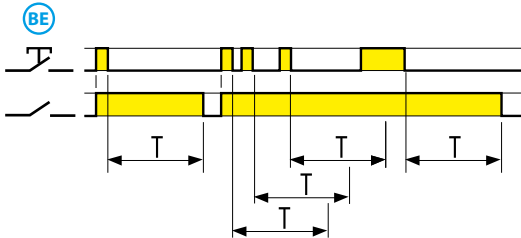

**(ME) Staircase timer + Staircase maintenance**

In addition to the Staircase timer function (BE), an impulse of  $\geq 5$  seconds will close the output contact for 60 minutes, after which time the contact will open. Ideal for maintenance or cleaning activities. The 60 minute timing can be interrupted by a further impulse of  $\geq 5$  seconds, and the output contact then opens

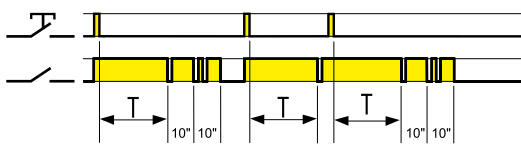

**(BP) Staircase timer with early warning**

On initial impulse the output contact closes and the timing starts for the pre-set duration. After the timing period, the output contact blinks off once; 10secs later the contact blinks off twice, and after a further 10secs the contact opens.  
During the pre-set and 20 second warning time, it is possible, by a further impulse, to extend the time by the full pre-set value.

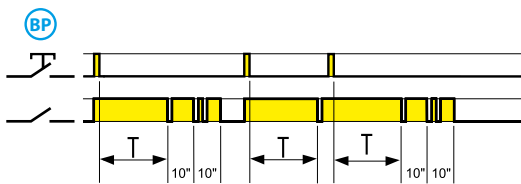

**(MP) Staircase timer with early warning + Staircase maintenance**

In addition to the Staircase timer function (BP), an impulse of  $\geq 5$  seconds will close the output contact for 60 minutes, after which time the contact will open. Ideal for maintenance or cleaning activities. The 60 minute timing can be interrupted by a further impulse of  $\geq 5$  seconds, and the output contact then opens

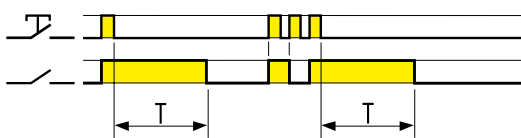

**(IT) Timing step relay**

On initial impulse the output contact closes and timing starts for the pre-set duration; On expiry of the time delay, the output contact opens.  
During the timing period it is possible to immediately open the contact with a further impulse.

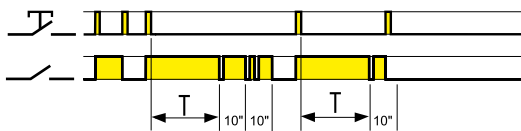

**(IP) Timing step relay with early warning**

On initial impulse the output contact closes and timing starts for the pre-set duration; After the timing period, the output contact blinks off once; 10 secs later the contact blinks off twice, and after a further 10 secs the contact opens.  
During the pre-set and 20 second warning time, it is possible to immediately open the output contact by a further impulse.



**(RI) Step relay**

After every impulse, the output contact changes state - alternately switching from open to closed and vice versa.

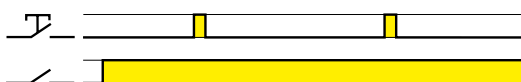

**Light ON**

With this function set - the output contact stays permanently closed.

NOTE: The blinking within the Early Warning functions (BP and IP) could cause re-start problems for fluorescent lamps with electromagnetic chokes (both conventional and compact types); We consequently suggest not to use such lamps with these functions.



## Functions

### Type 14.11 Functions selectable with front rotary selector

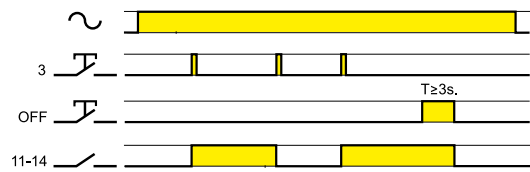

#### (RI) Step relay

The device works like a classic step relay: the output changes state each time pushbutton (3) is pressed. Pressing OFF for more than 3 seconds forces the output to the off state.

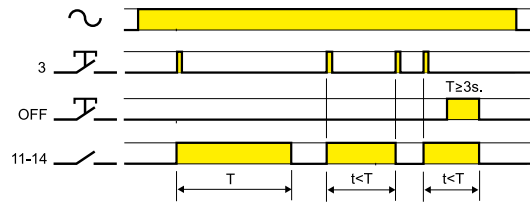

#### (IT) Timing step relay

On initial impulse the output contact closes and timing starts for the pre-set duration; On expiry of the time delay, the output contact opens. During the timing period it is possible to immediately open the contact with a further impulse. Pressing OFF for more than 3 seconds forces the output to the off state.

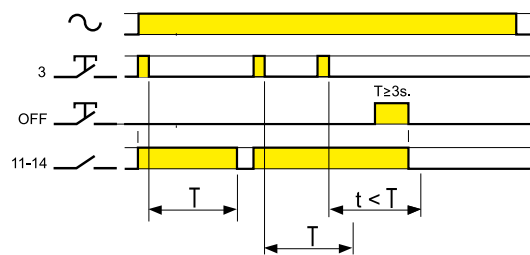

#### (BE) Staircase timer

On initial impulse the output contact closes and timing starts for the pre-set duration; subsequent impulses during the timing period will extend the timing period by the full pre-set value. On expiry of the time delay, the output contact opens. Pressing OFF for more than 3 seconds forces the output to the off state.



#### Light ON

With this function set - the output contact stays permanently closed.

### Type 14.71 Functions selectable with front selector

#### 3-function front selector

	⊖ Staircase timer +  Staircase maintenance
	⊖ Light ON
	⊖ Staircase timer (compatible with 18 series movement detectors)

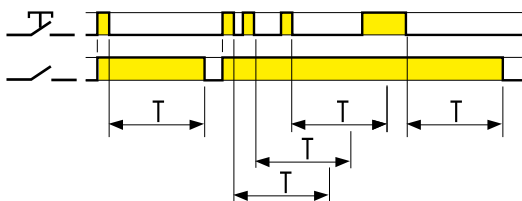

#### ⊖ Staircase timer

On initial impulse the output contact closes and timing starts for the pre-set duration; subsequent impulses during the timing period will extend the timing period by the full pre-set value. On expiry of the time delay, the output contact opens.

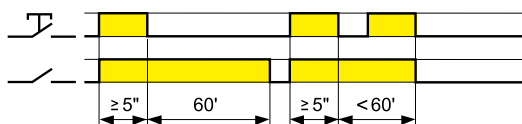

#### Staircase maintenance

An impulse of  $\geq 5$  seconds will close the output contact for 60 minutes, after which time the contact will open. Ideal for maintenance or cleaning activities. The 60' timing can be interrupted by a further impulse of  $\geq 5$  seconds, the output contact opens.

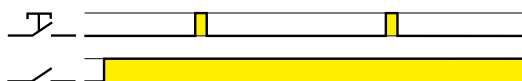

#### ⊖ Light ON

With this function set - the output contact stays permanently closed.

Functions

Type 14.81

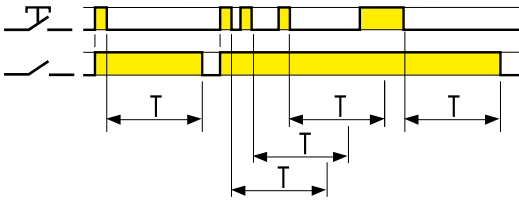

**Staircase timer**

On initial impulse the output contact closes and timing starts for the pre-set duration; subsequent impulses during the timing period will extend the timing period by the full pre-set value. On expiry of the time delay, the output contact opens.

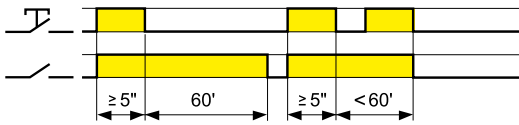

**"Staircase maintenance" function**

An impulse of  $\geq 5$  seconds will close the output contact for 60 minutes, after which time the contact will open. Ideal for maintenance or cleaning activities. The 60' timing can be interrupted by a further impulse of  $\geq 5$  seconds, which will re-establish the staircase timer function; so on expiry of the staircase time delay, the output contact opens.

Type 14.91

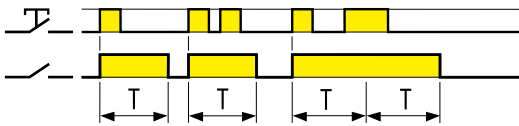

**Signal ON pulse**

On initial impulse the output contact closes, and remain so for the duration of the preset delay. On expiry of the time delay, the output contact opens.

Outline drawings

Type 14.01  
Screw terminal

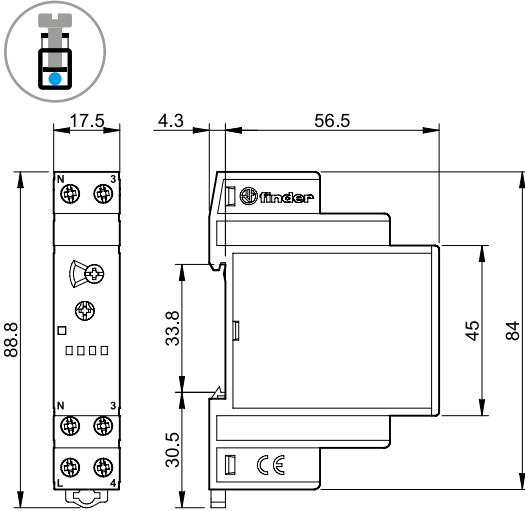

Type 14.11  
Screw terminal

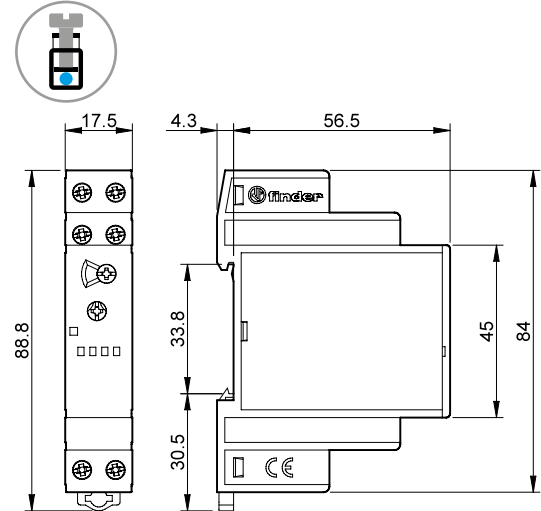

Type 14.71  
Screw terminal

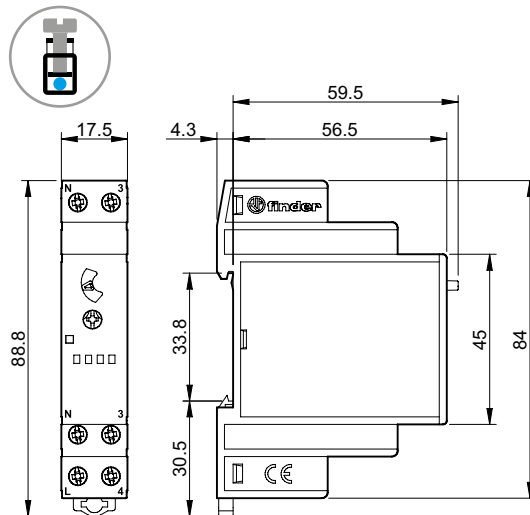

Type 14.81  
Screw terminal

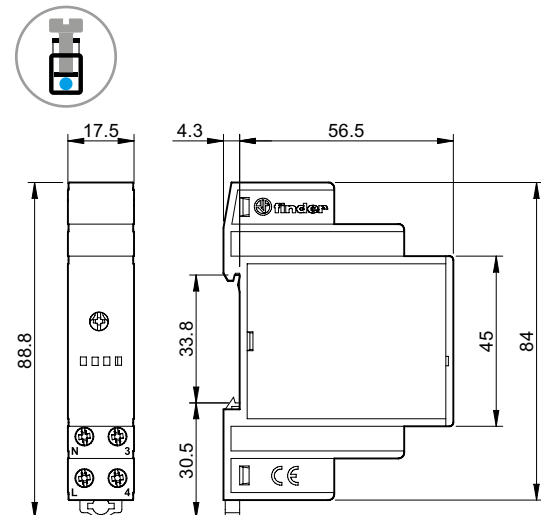

Type 14.91  
Screw terminal

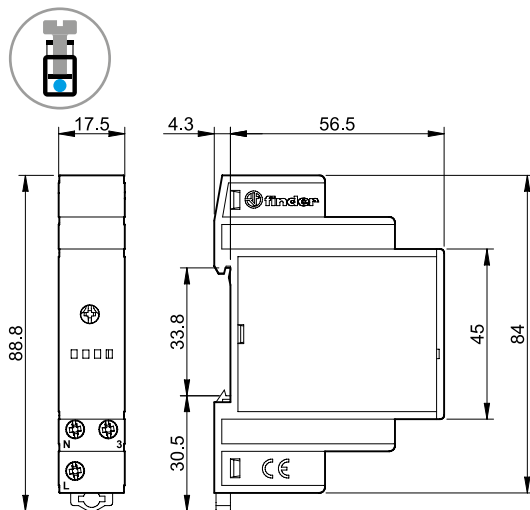



# Dimmers



Kitchen  
light control



Bedroom  
light control



Living room  
light control



Lighting control  
in corridors  
(for hotels, offices  
and hospitals)



**15**  
SERIES



**“Master + Slave” system for dimming multiple lighting loads of either single or mixed lamp technologies**

**Type 15.10 “Master”** - accepts input from a controlling push-button and outputs a dimming signal to a maximum of 32 x 15.11 slave dimmers, or other drivers or luminaires accepting a standardised 0-10 V/1-10 V signal

- Use with 4 wire connection
- “Soft” On and Off transitions
- Linear dimming
- Selectable operating modes with or without previous light level memory
- Staircase timer function

**Type 15.11 “Slave”** - accepts 1-10 V input from a 15.10 or other 0-10 V/1-10 V output device to dim a wide variety of lamps of different technology

- Selector switch for incandescent and halogen lighting loads (with or without transformer or electronic driver)
- Compatible with energy saving dimmable CFL or LED lamps and with all types of electromagnetic transformers
- Thermal protection against overload, thermofuse for extreme or short-circuit protection

Screw terminal



\* Maximum peak current of the contact 30 A 230 V AC. Use a contactor or power relay to switch loads exceeding this value  
For outline drawing see page 18

**“Master Dimmer” output specifications**

Driving signal (Output mode automatically configures to match input mode of the connected Driver)

Contact configuration

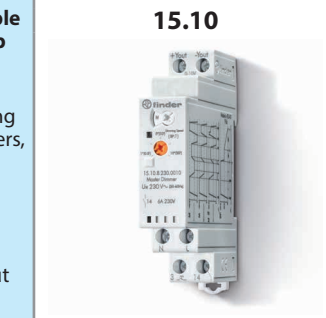

**“Master” dimmer**

- 0-10 V/1-10 V output to drive up to 32 x 15.11 slave dimmers or other similar devices
- Multi-function (with or without memory, including special “CFL with memory” function)
- Linear dimming
- Dimming speed setting
- Staircase timer function, with switch-off “early warning” signalled by lamps dimming
- 230 V AC supply, 50/60 Hz with automatic adjustment for frequency
- 6 A output relay contact\*
- 17.5 mm wide, modular, 35 mm rail mount



**“Slave” dimmer**

- 1-10 V input, driven by 15.10 or by other 0-10 V/1-10 V output devices
- Maximum lamp load 400 W
- 100 W load with energy saving dimmable lamps (LED and CFL)
- Leading and trailing edge dimming methods
- “Transformer” function (for use with electromagnetic transformers)
- Minimum dimming level setting
- 17.5 mm wide, modular, 35 mm rail mount

**“Slave Dimmer” output specifications**

Power max.

Power min.

Nominal lamp ratings:

230 V incandescent or halogen W

Toroidal electromagnetic transformers for LV halogen W

E-core electromagnetic transformers for LV halogen W

Electronic transformers (or ballasts) for LV halogen W

Dimmable compact fluorescent (CFL) W

230 V Dimmable LED Lamp W

230 V LED Strip W

Dimmable electronic transformers for LV LED W

**Supply specification**

Nominal voltage (U<sub>N</sub>) V AC (50/60 Hz)

Operating range

Stand-by power consumption

Dimming operating modes

**Technical data**

Dimming speed (total dimming time) s

Delay setting (staircase function) min

Max no. of illuminated push-button (≤ 1 mA)

Ambient temperature range °C

Protection category

0-10 V, +35 mA max (Active current sourcing mode)

1-10 V, -35 mA max (Passive current sinking mode)

1 NO (6 A/230 V AC)\*

W

W

—

—

—

—

—

—

—

—

—

—

—

110...230

(0.8...1.1) U<sub>N</sub>

0.5

—

1.5...10

0.5...20

15

-10...+50

IP 20

—

—

—

400

3

400<sup>(1)</sup>

400<sup>(2)</sup>

400<sup>(2)</sup>

400<sup>(1)</sup>

100<sup>(3)</sup>

100<sup>(3) or (1)</sup>

360<sup>(1)</sup>

—

100<sup>(1)</sup>

230

(0.8...1.1) U<sub>N</sub>

0.5

Trailing edge (  )  
Leading edge (  ) and (  )

—

—

—

-10...+50<sup>(4)</sup>

IP 20

**Approvals** (according to type)



**Note**

<sup>(1)</sup> Select “trailing edge” (  ) position on the front selector.

<sup>(2)</sup> Select “transformer” (  ) position on the front selector. Preferably, no more than 2 transformers.

<sup>(3)</sup> Select “leading edge” (  ) position on the front selector, and set the appropriate minimum dimming value (dependent on lamp type).

<sup>(4)</sup> With lamp load > 300 W (> 75 W for CFL or LED lamps), adequate ventilation must be provided - a gap of 9 mm on both side of the dimmer is suggested. Use the plastic separator type 022.09.

**Electronic dimmers for lamps of various technologies. All compatible with the direct drive of incandescent/halogen lamps and 230 V dimmable LED lamps**  
(Other lamps/drivers according to Type)

**Type 15.91**

- Mountable in wall box
- Leading edge dimming
- Linear dimming
- Automatically adjusts for supply frequency

**Type 15.51**

- Wall box or panel mount
- Trailing edge dimming
- Step or linear dimming
- Separate models for 50 and 60 Hz

**Type 15.81**

- 35 mm rail mount
- Leading or trailing edge dimming
- Also compatible with energy saving (CFL or LED) dimmable lamps and with most types of transformer/ballast drivers
- Linear dimming
- Automatically adjusts for supply frequency
- Thermo-fuse for extreme protection
- All Types suitable for incandescent and halogen lighting loads
- Use with 3 or 4 wire connection
- "Soft" On and Off transitions
- Two selectable operating modes: with or without previous light level memory
- Thermal protection against overload

Screw terminal





For outline drawing see page 18

**Output data**

Rated voltage	V AC	230	230	230
Power max.	W	100	400	500
Power min.	W	3	10	3
Nominal lamp ratings:				
230 V incandescent or halogen W		100	400	500 <sup>(1)</sup>
Toroidal electromagnetic transformers for LV halogen W		—	300 <sup>(2)</sup>	500 <sup>(3)</sup>
E-core electromagnetic transformers for LV halogen W		—	—	500 <sup>(3)</sup>
Electronic transformers (or ballasts) for LV halogen W		—	400 <sup>(4)</sup>	500 <sup>(1)</sup>
Dimmable compact fluorescent (CFL) W		—	—	100 <sup>(5)</sup>
230 V Dimmable LED Lamp W		50 <sup>(6)</sup>	50 <sup>(7)</sup>	100 <sup>(5)</sup>
230 V LED Strip W		—	—	450 <sup>(1)</sup>
Dimmable electronic transformers for LV LED W		50 <sup>(6)</sup>	50 <sup>(7)</sup>	100 <sup>(1)</sup>



**Supply specification**

Nominal voltage (U <sub>N</sub> )	V AC (50/60 Hz)	230	230 <sup>(8)</sup>	230
Operating range		(0.8...1.1)U <sub>N</sub>	(0.8...1.1)U <sub>N</sub>	(0.8...1.1)U <sub>N</sub>
Stand-by power consumption	W	0.4	0.7	0.5
Dimming operating mode		Leading edge	Trailing edge	Trailing edge (  ) Leading edge (  ) and (  )

**Technical data**

Ambient temperature range	°C	-10...+50 <sup>(9)</sup>	-10...+50 <sup>(9)</sup>	-10...+50 <sup>(10)</sup>
Protection category		IP 20	IP 20	IP 20

**Approvals** (according to type)**Note**

- (1) Select "incandescent lamp" (  ) position on the front selector.
- (2) One transformer only. Power-up only with the lamp load connected.
- (3) Select "transformer" (  ) position on the front selector. Preferably, no more than 2 transformers.
- (4) One transformer only.
- (5) Select "CFL" (  ) position on the front selector, and set the appropriate minimum dimming value (dependent on lamp type).
- (6) Only if lamps or electronic transformers are compatible with leading edge method.
- (7) Only if lamps or electronic transformers are compatible with trailing edge method.
- (8) Specific 60 Hz version available (see ordering information).
- (9) It is not recommended to mount more than one dimmer in the same wall box, unless adequate ventilation is provided or the lamp load is less than 100 W (15.51) or 50 W (15.91).
- (10) With lamp load > 300 W (> 75 W for CFL or LED lamps), adequate ventilation must be provided - a gap of 9 mm on both side of the dimmer is suggested. Use the plastic separator type 022.09.

Not compatible with illuminated push-buttons.

15.91



- Suitable for residential wall box mounting
- Maximum lamp load 100 W
- Leading edge dimming
- 2 modes - with or without memory
- 230 V AC supply, 50/60 Hz (with automatic adjustment for frequency)
- Linear dimming

15.51



- Suitable for wall box or panel mounting
- Maximum lamp load 400 W
- Trailing edge dimming
- Step or Linear dimming
- 2 modes - with or without memory
- 230 V AC supply (separate models for 50 and 60 Hz)

15.81



- 17.5 mm modular, 35 mm rail mount
- Maximum lamp load 500 W
- Multi-function
- Leading and trailing edge dimming methods (depending on the function)
- Compatible with energy saving (CFL or LED) dimmable lamps and most types of transformer/ballast drivers
- 230 V AC supply, 50/60 Hz (with automatic adjustment for frequency)



**YESLY Bluetooth Dimmers 230 V**

**Type 15.21.8.230.B300**

- Round wall box (ie: Ø 60mm) mounting

**Type 15.71**

- Wall mounting, compatible with most common Italian residential switch boxes: AVE, BTicino, Gewiss, Simon-Urmet, Vimar
- 7 functions, dependent on the load type
- Functions with or without memory
- Dimming operating mode Trailing edge or Leading edge
- Linear/exponential regulation
- Suitable for dimmable LED lamps, dimmable CFL lamps, halogen lamps, transformers or electronic power supplies
- Transmission range: approximately 10 m in free space and without obstacles
- "Soft" switching ON/OFF
- Over-temperature and short-circuit protection

**Universal electronic dimmer 230 V**

**Type 15.21.8.230.0200**

- Round wall box (ie: Ø 60mm) mounting
- Dimming operating mode Trailing edge or Leading edge
- "Soft" switching ON/OFF
- Over-temperature and short-circuit protection

Screw terminal



For outline drawing see page 18

Output data				
Rated voltage	V AC	230	230	230
Power max.	W	300	200	200
Power min.	W	3	3	3
Nominal lamp ratings:				
	230 V incandescent or halogen W	300	200	200
	Toroidal electromagnetic transformers for LV halogen W	300	—	200
	E-core electromagnetic transformers for LV halogen W	300	—	200
	Electronic transformers (or ballasts) for LV halogen W	300	200	200
	Dimmable compact fluorescent (CFL) W	150	—	100
	230 V Dimmable LED Lamp W	150	200	100
	230 V LED Strip W	270 <sup>(1)</sup>	180	180 <sup>(1)</sup>
	Dimmable electronic transformers for LV LED W	300	200	200
Supply specification				
Nominal voltage (U <sub>N</sub> )	V AC	230	230	230
Operating range		(0.8...1.1) U <sub>N</sub>	(0.8...1.1) U <sub>N</sub>	(0.8...1.1) U <sub>N</sub>
Stand-by power consumption	W	0.4	0.4	0.4
Technical data				
Dimming operating mode		Trailing edge / Leading edge	Trailing edge / Leading edge	Trailing edge / Leading edge
Ambient temperature range	°C	-10...+50	-10...+45	-10...+50
Protection category		IP 20	IP 20	IP 20
Approvals (according to type)				

**NEW 15.21.8.230.B300**

YESLY



- Transmission protocol Bluetooth Low Energy (BLE)
- 128 bit encrypted connection
- Configurable via Finder YOU app - compatible with iOS and Android operating systems
- Can be controlled through standard pushbuttons, BEYON or 013.B9 wireless pushbuttons
- Maximum dimmable power 300 W
- Status LED

**NEW 15.21.8.230.0200**



- Dimming operating mode Trailing edge or Leading edge
- No BLE interface
- Suitable for LED loads
- Maximum dimmable power 200 W LED
- Without memory

**NEW 15.71**

YESLY



- Transmission protocol Bluetooth Low Energy (BLE)
- 128 bit encrypted connection
- Configurable via Finder YOU app - compatible with iOS and Android operating systems
- Can be controlled through standard pushbuttons, BEYON or 013.B9 wireless pushbuttons
- Maximum dimmable power 200 W
- Status LED

**Note** <sup>(1)</sup> Select "Trailing edge" dimming operating mode from the application.

**PWM Dimmer for LED strip Bluetooth YESLY****Type 15.21.9.024.B200**

- Round wall box (ie: Ø 60mm) mounting
- LED strip
- "Soft" switching ON/OFF
- Protected against short-circuit, overload and reverse polarity
- Three PWM operating frequencies (selectable) - to counter "strobe" effect with camera

Screw terminal

**NEW** 15.21.9.024.B200

YESLY



- Transmission protocol Bluetooth Low Energy (BLE)
- 128 bit encrypted connection
- Configurable via Finder YOU app - compatible with iOS and Android operating systems
- Can be controlled through standard pushbuttons, BEYON or 013.B9 wireless pushbuttons
- Maximum dimmable power 192 W
- Three PWM operating frequencies (selectable) - to counter "strobe" effect with camera

For outline drawing see page 18

**Output data**

Rated voltage	V DC	12...24
Maximum current	A	8
LED strip:		
	24 V W	192
	12 V W	96

**Supply specification**

Nominal voltage (U <sub>N</sub> )	V DC	12...24
Operating range		—
Stand-by power consumption	W	—

**Technical data**

Dimming operating mode		PWM
Ambient temperature range	°C	-10...+50
Protection category		IP 20

**Approvals** (according to type)

**KNX Universal Dimmer with 2 channels**

- 2 x 400W channels
- LED indicators for each channel
- Thermal protection and short-circuit protection
- Manual override through front panel
- Scenario Management
- Power supply via KNX bus
- 35 mm rail (EN 60715) mounting
- Suitable for ETS 4 (or latest versions)

Screw terminal



**NEW** 15.2K.8.230.0400



- Dimming operating modes: Leading Edge or Trailing Edge, ETS configurable
- Suitable for many kind of loads: LED lamps, halogen, CFL, electronic and electromagnetic transformers

For outline drawing see page 14

Output data		
Rated voltage	V AC	230
Power max.	W	400
Power min.	W	2
Nominal lamp ratings 230 V:		
230 V incandescent or halogen W		400
Toroidal electromagnetic transformers for LV halogen W		400
E-core electromagnetic transformers for LV halogen W		400
Electronic transformers (or ballasts) for LV halogen W		400
Dimmable compact fluorescent (CFL) W		100
Dimmable 230 V LED W		100
Dimmable electronic transformers for LV LED W		100
Dimming operating modes		Leading Edge / Trailing Edge
Supply specification		
Type of BUS		KNX
Supply voltage	V DC	30
Rated consumption	mA	7
Technical data		
Ambient temperature range	°C	-5...+45
Protection category		IP 20
Approvals (according to type)		CE UK EAC

J



## Technical data

EMC specifications										
Type of test	Reference standard	15.51/15.91	15.10/11/81	15.21.8.230.0200	15.2K					
Electrostatic discharge	contact discharge	EN 61000-4-2	4 kV		4 kV					
	air discharge	EN 61000-4-2	8 kV		8 kV					
Radiated electromagnetic field	(80...1000 MHz)	EN 61000-4-3	3 V/m	10 V/m	10 V/m	3 V/m				
Fast transients (burst) (5-50 ns, 5 and 100 kHz)	on supply terminals	EN 61000-4-4	4 kV		4 kV					
	on pushbutton connection	EN 61000-4-4	4 kV		—					
Voltage pulses on supply terminals (surge 1.2/50 µs)	differential mode	EN 61000-4-5	2 kV		2.5 kV					
Radiofrequency common mode voltage (0.15...80 MHz)	on supply terminals	EN 61000-4-6	3 V		10 V					
	on pushbutton connection	EN 61000-4-6	3 V		10 V					
Voltage dips	70% U <sub>N</sub> , 40% U <sub>N</sub>	EN 61000-4-11	10 cycles		10 cycles					
Short interruptions		EN 61000-4-11	10 cycles		10 cycles					
Radiofrequency conducted emissions	0.15...30 MHz	EN 55015	class B		class B					
Radiated emissions	30...1000 MHz	EN 55015	class B		class B					
EMC specifications YESLY			15.21.8.230.B300/15.71		15.21.9.024.B200					
Electrostatic discharge	contact discharge	EN 61000-4-2	4 kV		4 kV					
	air discharge	EN 61000-4-2	8 kV		8 kV					
Radiated electromagnetic field	(80...1000 MHz)	EN 61000-4-3	10 V/m		10 V/m					
Fast transients (burst) (5-50 ns, 5 and 100 kHz)	on supply terminals	EN 61000-4-4	2 kV		2 kV					
	on pushbutton connection	EN 61000-4-4	4 kV		1 kV					
Voltage pulses on supply terminals (surge 1.2/50 µs)	differential mode	EN 61000-4-5	2 kV		1 kV					
Radiofrequency common mode voltage (0.15...80 MHz)	on supply terminals	EN 61000-4-6	10 V		10 V					
	on pushbutton connection	EN 61000-4-6	10 V		10 V					
Voltage dips	70% U <sub>N</sub> , 40% U <sub>N</sub>	EN 61000-4-11	10 cycles		10 cycles					
Short interruptions		EN 61000-4-11	10 cycles		10 cycles					
Radiofrequency conducted emissions	0.15...30 MHz	EN 55015 / ETSI EN 301489-1/ ETSI EN 301489-17	class B		class B					
Radiated emissions	30...6000 MHz	EN 55015 / ETSI EN 301489-1/ ETSI EN 301489-17	class B		class B					
Terminals		15.10/15.11/15.51/15.71/ 15.81/15.91		15.21		15.2K				
Max. wire size		solid cable	stranded cable	solid cable	stranded cable	solid cable	stranded cable			
	mm <sup>2</sup>	1 x 6 / 2 x 4	1 x 4 / 2 x 2.5	1 x 2.5 / 2 x 1.5	1 x 2.5 / 2 x 1	1 x 6 / 2 x 2.5	1 x 4 / 2 x 1.5			
	AWG	1 x 10 / 2 x 12	1 x 12 / 2 x 14	1 x 14 / 2 x 16	1 x 14 / 2 x 16	1 x 10 / 2 x 14	1 x 12 / 2 x 16			
Screw torque	Nm	0.8		0.5		0.5				
Wire strip length	mm	9				7				
Other data		15.10	15.11	15.21	15.51	15.71	15.81	15.91	15.2K	
Power lost to the environment	without load	W	0.5	0.5	0.4	0.7	0.4	0.5	0.4	—
	with rated load	W	1.7	2.5	2.5	2.2	2	2.6	1.2	—
Max cable length for push-button connection	m	100	100	100	100	100	100	100	—	
Max cable length for Master and Slaves connection	m	100 (keep separate from power cables)								

## Types 15.10 and 15.11

### Signaling

LED (15.10 only)	Condition
	Stand-by, output voltage < 1 V
	Active, output voltage ≥ 1 V
	Timing, staircase function

LED (15.11 only)	Condition
	Stand-by, input voltage < 1 V
	Active, input voltage ≥ 1 V
	Short circuit or overload, output disabled
	Overtemperature, output disabled

### Functions

#### Type Linear dimming

15.10		<p><b>Operating mode without memory:</b> at switch-off, the light level is not memorized.</p> <p><b>Long control pulse:</b> The light level is progressively raised or lowered in linear way. The lowest value depending on the “minimum dimming level” regulator setting (on 15.11).</p> <p><b>Short control pulse:</b> Alternately switches between On and Off (maximum light level and the off state).</p>
		<p><b>Operating mode with memory:</b> the previous light level is memorized.</p> <p><b>Long control pulse:</b> The light level is progressively raised or lowered in linear way. The lowest value dependent on the “minimum dimming level” regulator setting (on 15.11).</p> <p><b>Short control pulse:</b> Alternately switches between On and Off. When switching On, the light level assumes the value set during the previous On state.</p>
		<p><b>Operating mode with memory:</b> the previous light level is memorized, specific for CFL Lamp.</p> <p><b>Long control pulse:</b> The light level is progressively raised or lowered in linear way. The lowest value dependent on the “minimum dimming level” regulator setting (on 15.11).</p> <p><b>Short control pulse:</b> Alternately switches between On and Off. When switching On, the light level reach the full value for a very short time (in order to guarantee the correct lamp turn-on), then immediately assumes the value set during the previous On state.</p>
		<p><b>Staircase relay with early warning</b> On initial impulse the output closes and the timing starts for the pre-set duration. After the timing period (T), the output power is reduced to 50% for 10 seconds; then in the last 30 seconds it will be further reduced to the final shutdown. During the pre-set and 40 seconds warning time, it is possible, by a further impulse, to extend the time by the full pre-set value.</p>

### Type of load - Type 15.11

Type of load	Selector setting	Regulator setting
<ul style="list-style-type: none"> <li>Incandescent lamps</li> <li>230 V halogen lamps</li> <li>12/24 V halogen and LED lamps with electronic transformer/ballast</li> </ul>	<p>(Trailing Edge)</p>	<p>It is suggested to set the “minimum dimming level” at the lowest value, so that the complete dimming range is available. But if it is necessary to avoid too low a level of illumination, a higher value can be set.</p>
<ul style="list-style-type: none"> <li>Dimmable compact fluorescent lamps (CFL)</li> <li>Dimmable LED lamps</li> </ul>	<p>(Leading Edge)</p>	<p>It is suggested to initially set the “minimum dimming level” at an intermediate value and then if necessary, readjust for a level found to be compatible with the lamp being used.</p>
<ul style="list-style-type: none"> <li>12/24 V halogen lamps with toroidal or E-core electromagnetic transformer</li> </ul>	<p>(Leading Edge)</p>	<p>It is suggested to set the “minimum dimming level” at the lowest value, so that the complete dimming range is available. But if it is necessary to avoid too low a level of illumination, a higher value can be set.</p>

## Type 15.51 and 15.91

### Functions

Type	Step dimming
15.51...0400	<p><b>Operating mode 1 (with memory):</b> the previous light level is memorized.</p> <p><b>Long control pulse:</b> The light level is progressively raised or lowered through a maximum of 10 incremental steps.</p> <p><b>Short control pulse:</b> Alternately switches between On and Off. When switching On, the light level assumes the value set during the previous On state.</p>
	<p><b>Operating mode 2 (without memory):</b> on switch off, the light level is not memorized.</p> <p><b>Long control pulse:</b> The light level is progressively raised or lowered through a maximum of 10 incremental steps.</p> <p><b>Short control pulse:</b> Alternately switches On or Off between the maximum light level and the off state.</p>
Type	Linear dimming
15.51...0404 15.91...0000	<p><b>Operating mode 3 (with memory):</b> the previous light level is memorized.</p> <p><b>Long control pulse:</b> The light level is progressively raised or lowered.</p> <p><b>Short control pulse:</b> Alternately switches between On and Off. When switching On, the light level assumes the value set during the previous On state.</p>
	<p><b>Operating mode 4 (without memory):</b> on switch off, the light level is not memorized.</p> <p><b>Long control pulse:</b> The light level is progressively raised or Lowered.</p> <p><b>Short control pulse:</b> Alternately switches On or Off between the maximum light level and the off state.</p>

## Operating mode setup

### Type 15.51

On 15.51 operating mode 1 or 3 (with memory) is preset, but it is possible to change it using the following sequence:

- remove the supply voltage;
  - press the control button;
  - apply the supply to the relay, keeping the button closed for 3 second;
  - on button release, the light will flash twice to indicate the selection of operating mode 2 or 4, or flash once for operating mode 1 or 3.
- Repeating the above steps will alternately change between operating modes.

### Type 15.91

On 15.91 operating mode 4 (without memory) is preset, but it is possible to change it using the following sequence:

- remove the supply voltage;
  - press the control button;
  - apply the supply to the relay, keeping the button closed for 3 second;
  - on button release, the light will flash twice to indicate the selection of operating mode 3, or flash once for operating mode 4.
- Repeating the above steps will alternately change between operating modes.

### Type 15.21.8.230.0200

The dimmer is pre-set for "Trailing edge" dimming, but it is possible to set "Leading edge" using the following sequence:

- disconnect the power supply;
- press and hold down a push-button;
- restore power while holding down the button until the lamp produces one or two flashes and, at this point, release the button. If 2 flashes are emitted the new set method will be Leading Edge, if only one flash is emitted the method will be Trailing Edge

## Type 15.81

### Thermal protection and signaling

LED (15.81 type only)	Supply voltage	Thermal protection
	OFF	—
	ON	—
	ON	ALARM

#### ALARM

The internal thermal protection (active on all dimmer types) will detect an unsafe temperature, due to overload or incorrect installation, and will turn the dimmer output off. It is possible to turn the dimmer on, by push button, only when the temperature reduces to a safe level (after 1 to 10 minutes, depending on installation conditions) and after removing the cause of the overload.

## Functions

### Type Linear dimming

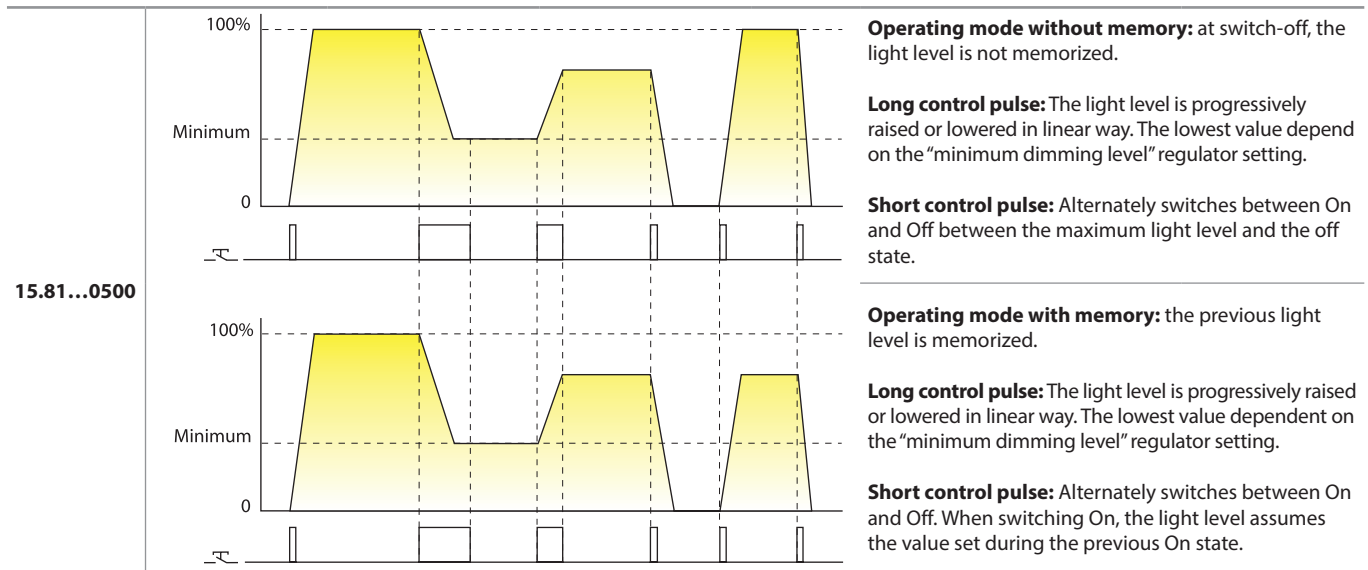

Type of load	Selector setting		Regulator setting
	With memory (M)	Without memory (M)	
<ul style="list-style-type: none"> <li>Incandescent lamps</li> <li>230 V halogen lamps</li> <li>12/24 V halogen lamps with electronic transformer/ballast</li> </ul>			<p>It is suggested to set the “minimum dimming level” at the lowest value, so that the complete dimming range is available. But if it is necessary to avoid too low a level of illumination, a higher value can be set.</p>
<ul style="list-style-type: none"> <li>Dimmable compact fluorescent lamps (CFL)</li> <li>Dimmable LED lamps</li> </ul>			<p>It is suggested to initially set the “minimum dimming level” at an intermediate value and then if necessary, readjust for a level found to be compatible with the lamp being used.</p>
<ul style="list-style-type: none"> <li>12/24 V halogen lamps with toroidal or E-core electromagnetic transformer</li> </ul>			<p>It is suggested to set the “minimum dimming level” at the lowest value, so that the complete dimming range is available. But if it is necessary to avoid too low a level of illumination, a higher value can be set.</p>



## Dimming methods

### Phase cutting:

Leading edge dimming

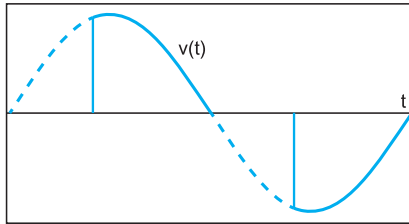

Trailing edge dimming

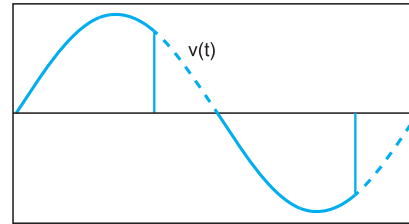

Light dimming is realized with “phase cutting technology”, which works by “cutting off” part of the mains voltage waveform in order to reduce the RMS voltage fed to the lamp. When the “cut off” part is at the beginning of each half cycle the dimming method is called Leading Edge. When it is towards the end of each half cycle, it is called Trailing Edge. These 2 methods are suitable for dimming different lamp types: Trailing Edge is, in general, more suitable for electronic transformers for low voltage lamps (halogen or LED). Leading Edge is better suited for electromagnetic transformers for LV lamps, 230 V CFL and 230 V LED lamps. Both methods are, however, suitable for dimming 230 V halogen and incandescent lamps.

In consideration of the different lamp types actually available on the market, it is suggested to refer to the technical specification indicated in page 3 and, if given, to the lamp manufacturer’s recommendation.

### PWM:

“Pulse Width Modulation” regulates electrical power by modulating the width of the ON time relative to the OFF time. The higher the duty cycle, the greater the power applied to the load. PWM is exclusively for direct current and is used particularly for the dimming of DC LED strips. In this case, the dimmer is positioned downstream of the power supply.

Duty Cycle 10 %

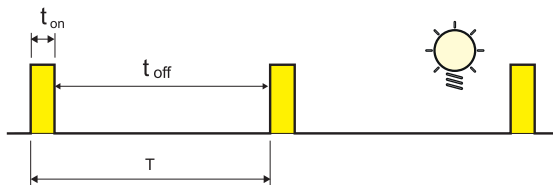

Duty Cycle 90 %

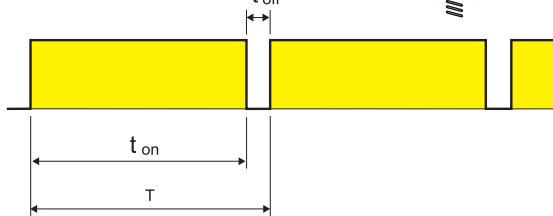







## Types 15.21 and 15.71 (BLE only)

### Dimmer setting

The dimming function can be set via Finder YOU app, available for iOS and Android systems.  
This product is ready-to-use with the factory setting: 1 – LEDRC1; Trailing edge linear control curve.

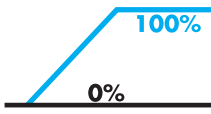
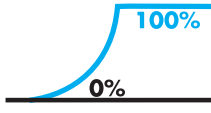
### Functions

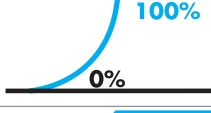
Settable via app.

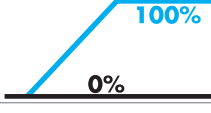
Load type	Function	Driving method	Control curve
LED lamps, Halogen, electronic transformers <b>LED</b>  	1	TE Trailing Edge	Linear 
	2	LE Leading Edge	
LED <b>LED</b>	3	TE Trailing Edge	Exponential 
	4	LE Leading Edge	
CFL lamps 	5	TE Trailing Edge	Exponential 
	6	LE Leading Edge	
Electromechanical transformers 	7	LE Leading Edge	Linear 
<b>AUTO</b>	<b>AUTOMATIC</b>		

**AUTO:** the automatic function verifies with a special algorithm the driving method (Trailing edge or Leading edge) best suited to the applied load. If the AUTO function is selected, the dimmer carries out a check switching on the load with two working cycles each time the dimmer is powered from the L & N (even after a blackout). These cycles allow the dimmer to set the right driving method.

**Control curve:** the Linear or Exponential control curve is useful in achieving the most visually appealing change in light intensity - according to the type of load being used.

### Parameters

Settable via Finder YOU app.

**Minimum light value:** Minimum value of load intensity.

**Switch time:** Switching ON/OFF time.

**Regulation time:** Time to reach the highest or lower light value.

**Scene time:** Reaching the value recalled by a scenario.

**Memory:** Remembers the brightness value before power off.

**Restore after blackout:** Restoring the light intensity to the value prior to a loss of power.

## Wiring diagrams - Types 15.10 and 15.11

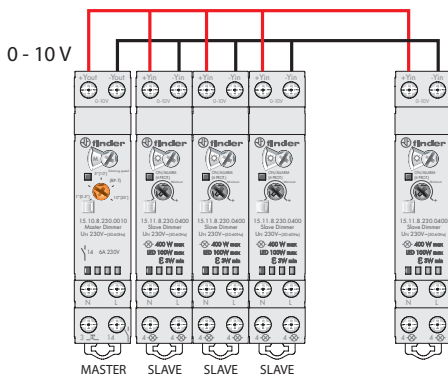

This new system is modular, adaptable to every need and allows control of multiple lamps through a single control device called the "Master Dimmer" Type 15.10.8.230.0010.

The Master Dimmer, produces a 0 - 10 V signal proportional to the dimming value needed: 0 V corresponds to 0% (light off); 5 V equals 50%, 10 V corresponds to the maximum brightness (100% on).

The 0 - 10 V output signal terminals Yout + / Yout - of the "Master Dimmer" must be connected to terminals + Yin / Yin - of one or more 15.11.8.230.0400, called the "Slave Dimmers", which have the task of changing the voltage applied to the lamps and therefore their brightness.

The result is a flexible system that offers a range of solutions from the minimum configuration of a Master Dimmer and a Slave Dimmer, up to the maximum configuration of a Master Dimmer and 32 Slave Dimmers.

Each slave can drive a different lamp type, depending on the appropriate methodology, "Leading Edge" or "Trailing Edge". It can regulate halogen lamps, dimmable LED lamps, dimmable CFL lamps, electronic transformers, and electromagnetic transformers.

For example, one Master Dimmer can control a Slave Dimmer with LED lamps and at the same time a second Slave Dimmer with halogen lamps, and a third with electronic transformers.

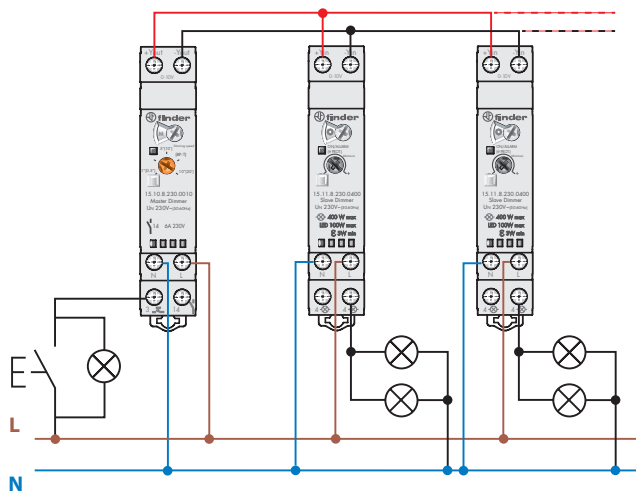

### MASTER DIMMER TYPE 15.10 AND SLAVE DIMMER TYPE 15.11

It is recommended that the Master controls from one to a maximum of 32 Slave units.

The push-buttons (including illuminated push-buttons Max. 15) serve as the ON / OFF (momentary push), or when pressed for a longer time they adjust the brightness level.

Each Slave can drive a different load type.

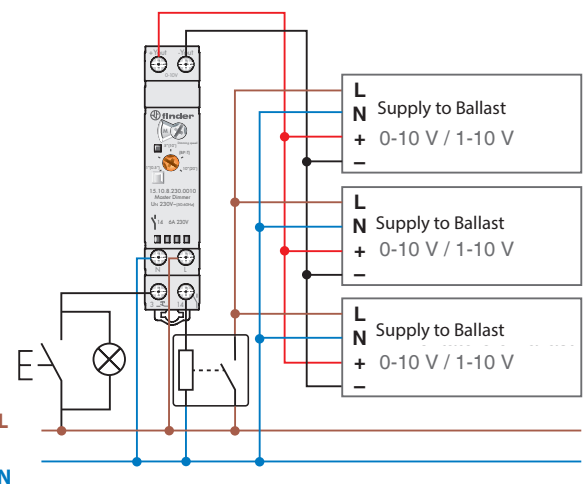

### MASTER DIMMER + 0 - 10 V ELECTRONIC TRANSFORMER OR BALLAST

Using only the Master Dimmer it is possible to control electronic transformers or ballasts with a 0 - 10 V / 1 - 10 V input (observing correct polarity).

For 1 - 10 V applications it is suggested to supply the Ballast Live from terminal 14. This will ensure that the supply to the Ballast is cut-off for a signal < 1 V.

Note: Check that the maximum Peak Current of the Ballast does not exceed the 30 A 230 V AC rating of terminal 14. Use a contactor or power relay to switch loads exceeding this value.

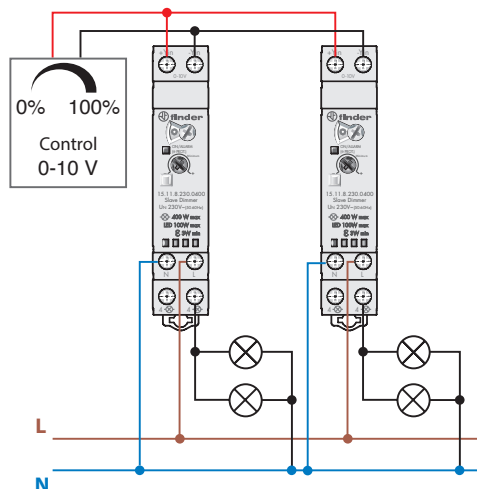

### BMS 0 - 10 V OUTPUTS + SLAVE DIMMERS

In the case of Home Automation or Building Automation systems you can use just the Slave Dimmer Type 15.11 directly controlled by the 0 - 10 V output of the building management system (BMS), or by 0 - 10 V rotary regulators.

**Wiring diagrams - Types 15.51, 15.71, 15.81 and 15.91**

**Note:** remember to maintain a ground/earth connection for class 1 light fittings.

**Type 15.51 - 3 wire connection**

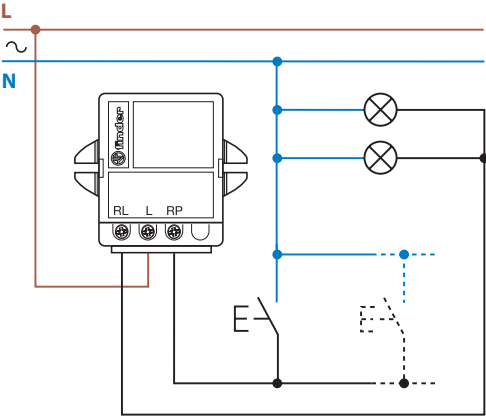

**Type 15.51 - 4 wire connection**

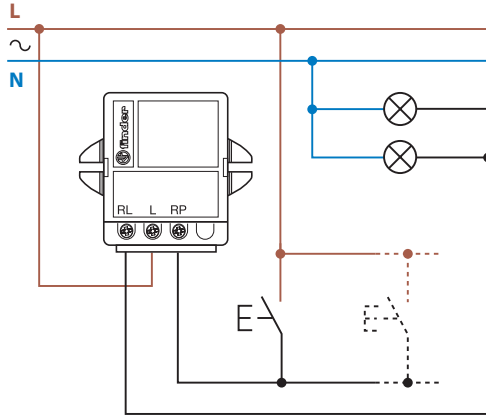

**Type 15.91 - 3 wire connection**

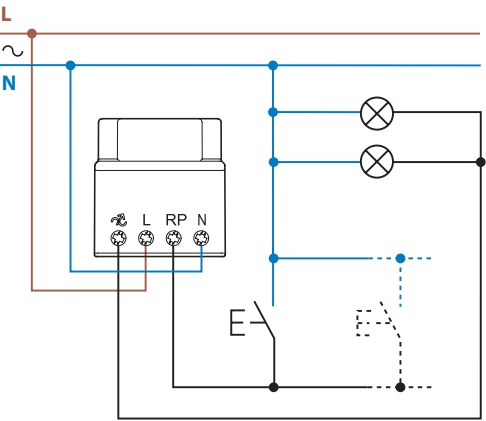

**Type 15.91 - 4 wire connection**

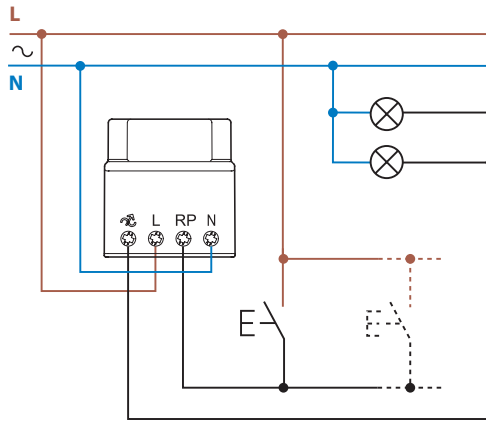

**Type 15.81 - 3 wire connection**

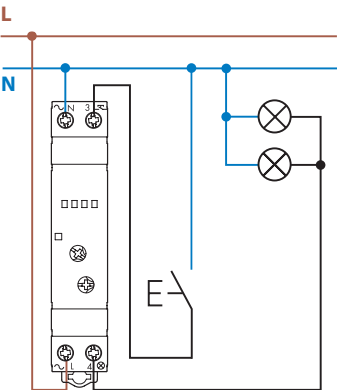

**Type 15.81 - 4 wire connection**

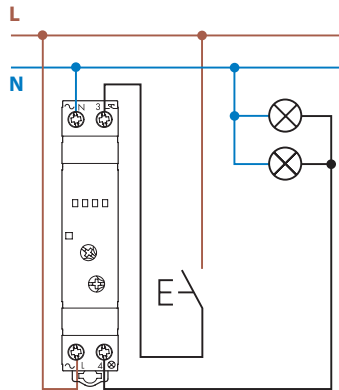

**Type 15.71 - 4 wire connection**

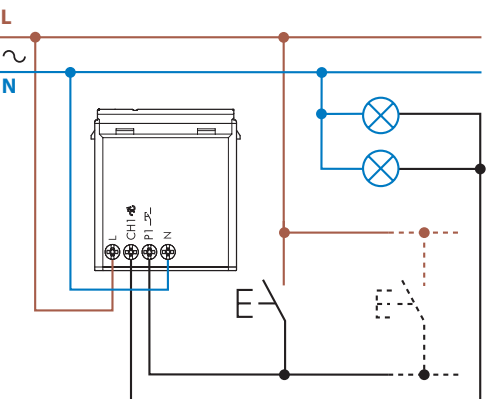

### Wiring diagram - Type 15.21

Type 15.21.8.230.xxxx - 4 wire connection

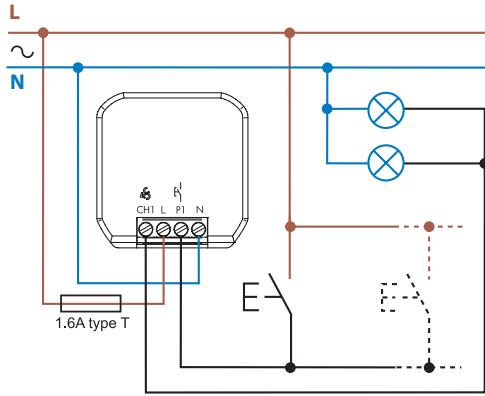

Type 15.21.9.024.B200

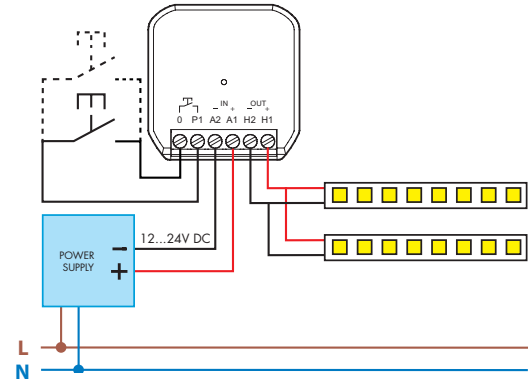

### Wiring diagram - Type 15.2K

Type 15.2K

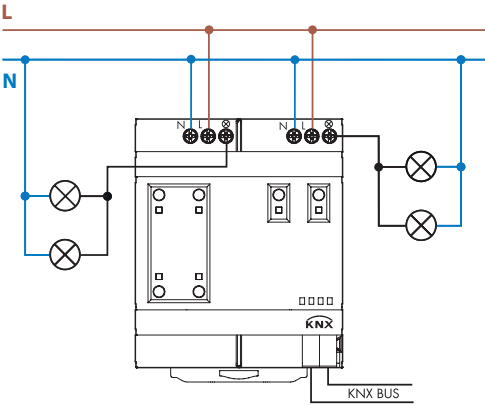

### Outline drawings

Type 15.2K  
Screw terminal

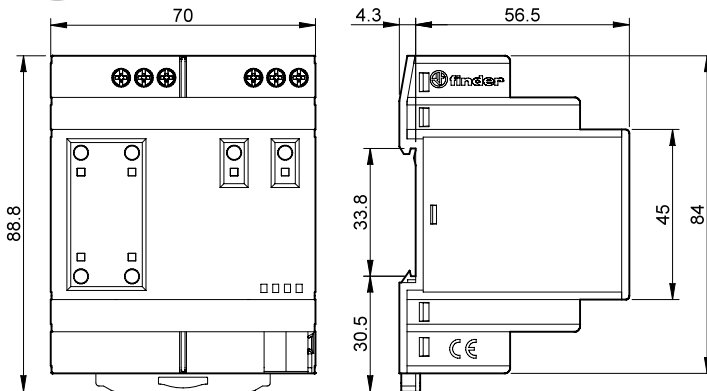

Outline drawings

Type 15.51  
Screw terminal

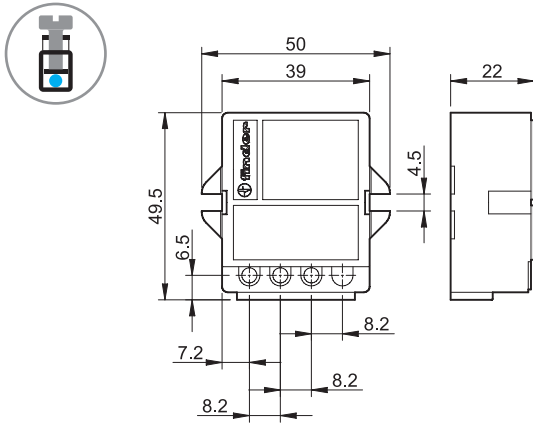

Type 15.91  
Screw terminal

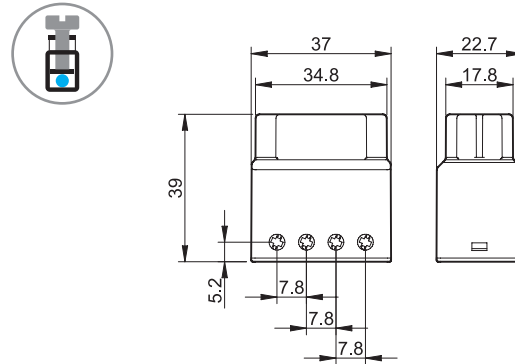

Type 15.10  
Screw terminal

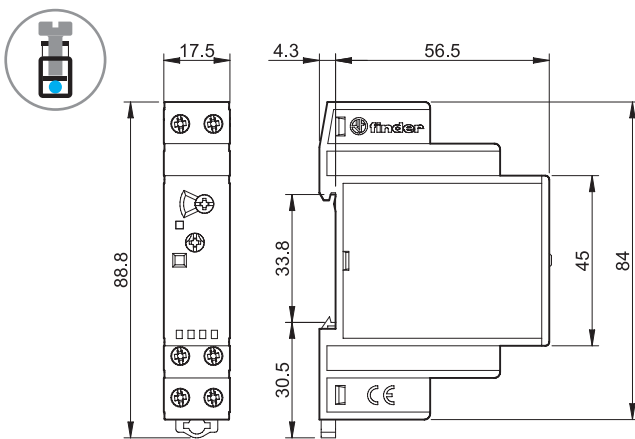

Type 15.11  
Screw terminal

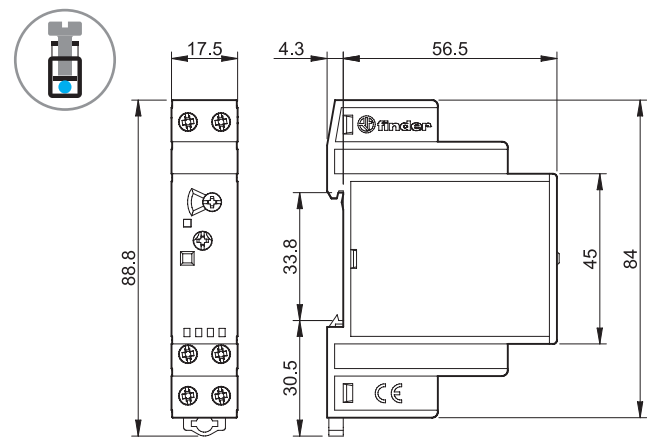

Type 15.81  
Screw terminal

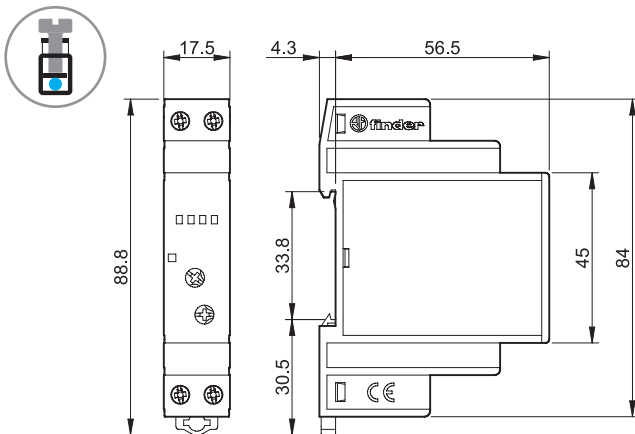

Type 15.71 - YESLY  
Screw terminal

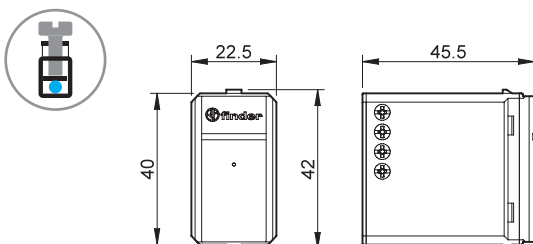

Type 15.21  
Screw terminal

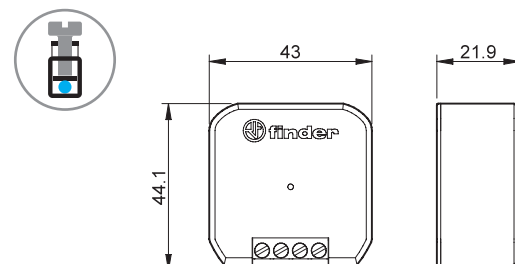

Accessories



020.01

**Adaptor for panel mounting** for types 15.10, 15.11 and 15.81, plastic, 17.5 mm wide | 020.01

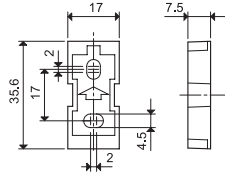

022.09

**Separator for rail mounting**, plastic, 9 mm wide for types 15.10, 15.11 and 15.81 | 022.09

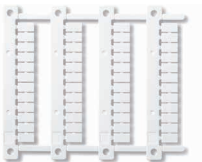
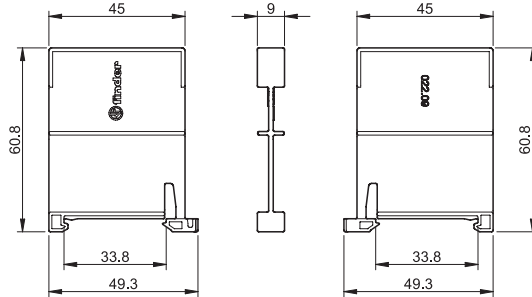

060.48

**Sheet of marker tags** for types 15.10, 15.11 and 15.81, plastic, 48 tags, 6 x 12 mm | 060.48



022.18



**8-way jumper link** for type 15.10 and 15.11 connection, 17.5 mm wide | 022.18 (blue)

Rated values

10 A - 250 V

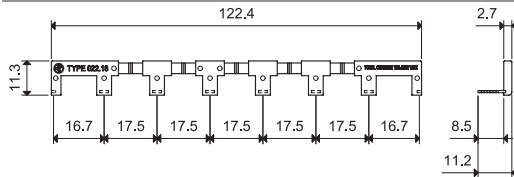

015.0.230

**Leakage current suppression module.**

It absorbs the leakage current on the LED lamps, when, with the Dimmer off, the lamps do not turn off completely but remain on at minimum. It absorbs 0.8 W at 230 V AC.

015.0.230

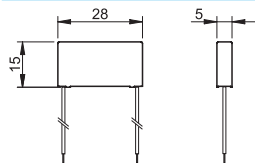

**Connection example - Type 15.21**

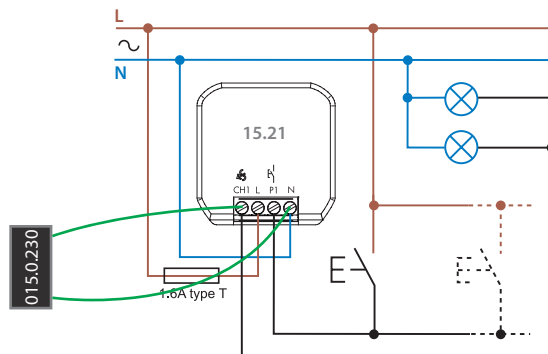

## Accessories



013.00

**Pushbutton phase/neutral converter.** Use this with a pre-existing neutral wired pushbutton when retro fitting a device designed only for phase connected pushbuttons. This avoids any radical change to the existing wiring.

013.00

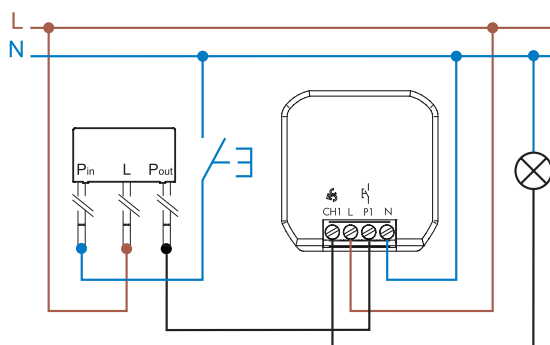

013.17

**Adapter for DIN rail,** to install devices 15.21 in the electrical panel.

013.17

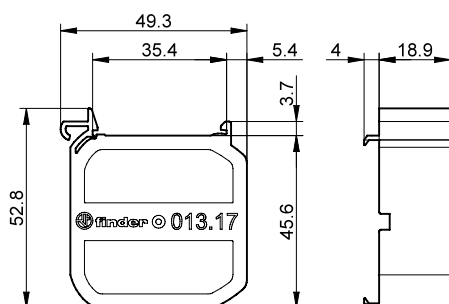



# PIR movement and presence detectors 10 A



Hotel room energy management systems



Offices, swimming baths and schools



Staircase light control



Lighting control in corridors (for hotels, offices and hospitals)



18  
SERIES





**PIR movement detectors for internal or external installations - wall mounting**

**Type 18.01**

- Internal installation
- Surface mounting

**Type 18.11**

- External installation (IP54)
- Surface mounting

**Type 18.A1**

- External mounting (IP55)
- Terminal for PE connection
- Push-in terminals

- Output contact connected to supply live
- Small size
- Adjustable ambient light intervention threshold
- Adjustable Light ON Time
- Universal mounting position - permits the selection of any area for survey
- Wide angle of survey

18.01/18.11  
Screw terminal

18.A1  
Push-in terminal



NOTE: with 110...125 V AC supply, the Ratings (AC1, AC15 and lamp loads) must be reduced by 50 % (e.g. 500 W instead of 1000 W)

For outline drawings see page 18

**Contact specification**

	18.01	18.11	18.A1
Number of contacts	1 NO (SPST-NO)	1 NO (SPST-NO)	1 NO (SPST-NO)
Rated current/Maximum peak current	10/20 (100 A - 5 ms)	10/20 (100 A - 5 ms)	10/20 (100 A - 5 ms)
Rated voltage/Maximum switching voltage	230/230	230/230	230/230
Rated load AC1	2300	2300	2300
Rated load AC15 (230 V)	450	450	450
Nominal lamp rating 230 V:			
incandescent/halogen W	1000	1000	1000
fluorescent lamp with electronic ballast W	500	500	500
fluorescent lamp with electromagnetic ballast W	350	350	350
CFL W	300	300	300
LED 230 V W	300	300	300
halogen or LV LED with electronic ballast W	300	300	300
halogen or LV LED with electromagnetic ballast W	500	500	500
Standard contact material	AgSnO <sub>2</sub>	AgSnO <sub>2</sub>	AgSnO <sub>2</sub>
<b>Supply specification</b>			
Coil specification	V AC (50/60 Hz)	120...230	120...230
	DC	—	—
Rated power AC/DC	VA (50 Hz)/W	2.5/—	2.5/—
Operating range	V AC (50/60 Hz)	96...253	96...253
	DC	—	—
<b>Technical data</b>			
Electrical life at rated load AC1	cycles	100 · 10 <sup>3</sup>	100 · 10 <sup>3</sup>
Ambient light intervention threshold	lx	5...350	5...1000
Light ON time after last detection		10 s...12 min	10 s...12 min
Sensing area		See diagram page 15	See diagram page 15
Ambient temperature range	°C	-10...+50	-30...+50
Protection category		IP 40	IP 54
Protection category		IP 54	IP 55
<b>Approvals</b> (according to type)		CE UK CA EAC	CE UK CA EAC

18.01



- 1 NO 10 A
- Internal installations

18.11



- 1 NO 10 A
- External installations
- Protection category IP 54

NEW 18.A1



- 1 NO 10 A
- External installations
- Protection category IP 55
- PE terminal
- Push-in terminals

**PIR movement detectors for internal installations - ceiling mount**
**Type 18.21**

- Surface mounting

**Type 18.31**

- Recess mounting

**Type 18.31-0031**

- High ceiling type (6 meter max.)
- Surface or recess mounting

- Output contact connected to supply live
- Small size
- Adjustable ambient light intervention threshold
- Adjustable Light ON Time
- Wide angle of survey

18.21/18.31/18.31...0031

Screw terminal



NOTE: with 110...125 V AC supply, the Ratings (AC1, AC15 and lamp loads) must be reduced by 50 % (e.g. 500 W instead of 1000 W)

For outline drawings see page 18

**Contact specification**

		18.21	18.31	18.31-0031
Number of contacts		1 NO (SPST-NO)	1 NO (SPST-NO)	1 NO (SPST-NO)
Rated current/Maximum peak current	A	10/20 (100 A - 5 ms)	10/20 (100 A - 5 ms)	10/20 (100 A - 5 ms)
Rated voltage/Maximum switching voltage	V AC	230/230	230/230	230/230
Rated load AC1	VA	2300	2300	2300
Rated load AC15	(230 V) VA	450	450	450
Nominal lamp rating 230 V:				
	incandescent/halogen W	1000	1000	1000
	fluorescent lamp with electronic ballast W	500	500	500
	fluorescent lamp with electromagnetic ballast W	350	350	350
	CFL W	300	300	300
	LED 230 V W	300	300	300
	halogen or LV LED with electronic ballast W	300	300	300
	halogen or LV LED with electromagnetic ballast W	500	500	500
Standard contact material		AgSnO <sub>2</sub>	AgSnO <sub>2</sub>	AgSnO <sub>2</sub>

**Supply specification**

		18.21	18.31	18.31-0031
Coil specification	V AC (50/60 Hz)	120...230	120...230	120...230
	DC	—	—	—
Rated power AC/DC	VA (50 Hz)/W	2/1	2/1	2/1
Operating range	V AC (50/60 Hz)	96...253	96...253	96...253
	DC	—	—	—

**Technical data**

		18.21	18.31	18.31-0031
Electrical life at rated load AC1	cycles	100 · 10 <sup>3</sup>	100 · 10 <sup>3</sup>	100 · 10 <sup>3</sup>
Ambient light intervention threshold	lx	5...350	5...350	5...350
Light ON time after last detection		10 s...12 min	10 s...12 min	30 s...35 min
Sensing area		See diagram page 15	See diagram page 15	See diagram page 15
Ambient temperature range	°C	-10...+50	-10...+50	-10...+50
Protection category		IP 40	IP 40	IP 40

**Approvals (according to type)**

- 1 NO 10 A
- Surface mounting



- 1 NO 10 A
- Recess mounting



- 1 NO 10 A
- High ceiling applications (up to 6 meters)
- Light ON time after last detection (30 s...35 min)



**PIR movement detectors for internal installations, with volt-free output contact**

**Type 18.21-0300**

- Surface mounting

**Type 18.31-0300**

- Recess mounting

- Applications where interface to PLC or BMS is required
- Ceiling mounting
- Small size
- Adjustable ambient light intervention threshold
- Adjustable Light ON Time
- Wide angle of survey

18.21...0300/18.31...0300  
Screw terminal



NOTE: with 110...125 V AC supply, the Ratings (AC1, AC15 and lamp loads) must be reduced by 50 % (e.g. 500 W instead of 1000 W)

For outline drawings see page 17

**18.21-0300**



- 1 NO 10 A
- Surface mounting

**18.31-0300**



- 1 NO 10 A
- Recess mounting

**Contact specification**

Number of contacts		1 NO (SPST-NO)	1 NO (SPST-NO)
Rated current/Maximum peak current	A	10/20 (100 A - 5 ms)	10/20 (100 A - 5 ms)
Rated voltage/ Maximum switching voltage	V AC	250/400	250/400
Rated load AC1	VA	2500	2500
Rated load AC15	(230 V) VA	450	450
Nominal lamp rating 230 V:			
incandescent/halogen W		1000	1000
fluorescent lamp with electronic ballast W		500	500
fluorescent lamp with electromagnetic ballast W		350	350
CFL W		300	300
LED 230 V W		300	300
halogen or LV LED with electronic ballast W		300	300
halogen or LV LED with electromagnetic ballast W		500	500
Standard contact material		AgSnO <sub>2</sub>	AgSnO <sub>2</sub>

**Supply specification**

Coil specification	V AC (50/60 Hz)	120...230	120...230
	V AC (50/60 Hz)/DC	24	24
Rated power AC/DC	VA (50 Hz)/W	2/1	2/1
Operating range	V AC (50/60 Hz)	96...253	96...253
	V AC (50/60 Hz)/DC	19.2...26.4	19.2...26.4

**Technical data**

Electrical life at rated load AC1	cycles	100 · 10 <sup>3</sup>	100 · 10 <sup>3</sup>
Ambient light intervention threshold	lx	5...350	5...350
Light ON time after last detection		10 s...12 min	10 s...12 min
Sensing area		See diagram page 15	See diagram page 15
Ambient temperature range	°C	-10...+50	-10...+50
Protection category		IP 40	IP 40

**Approvals** (according to type)



**Movement and presence detectors with Push-in terminals For internal installation**

**Type 18.51**

- Standard version
- Volt-free output contact

**Type 18.51-0040**

- Possibility to connect external push-button to force the output state
- Dynamic light compensation
- Output contact connected to supply live

**Type 18.51-B300**

- Programmable via Bluetooth LE (Low Energy) using Android and iOS smartphones
- Extensive sensing area up to 64 m<sup>2</sup>
- Two sensing areas: "presence" suitable for zones of low activity, and "movement" suitable for transit areas or zones of high activity
- Modern design
- Quick installation thanks to push-in terminals
- 1 NO contact 10 A, with "zero crossing" switching
- Wall mounting compatible with 60 mm box and 2 or 3 module box
- Double terminals for easy "looping" in and out

18.51/18.51...0040/18.51...B300

Push-in terminal



NOTE: with 110...125 V AC supply, the Ratings (AC1, AC15 and lamp loads) must be reduced by 50 % (e.g. 500 W instead of 1000 W)

For outline drawings see page 17

**Contact specification**

	18.51	NEW 18.51...0040	NEW 18.51...B300
Number of contacts	1 NO (SPST-NO)	1 NO (SPST-NO)	1 NO (SPST-NO)
Rated current/Maximum peak current	A 10/20 (100 A - 5 ms)	10/20 (100 A - 5 ms)	10/20 (100 A - 5 ms)
Rated voltage/Maximum switching voltage	V AC 250/400	230/230	230/230
Rated load AC1	VA 2500	2300	2300
Rated load AC15	(230 V) VA 450	450	450
Nominal lamp rating 230 V:			
incandescent/halogen W	1000	1000	1000
fluorescent lamp with electronic ballast W	500	500	500
fluorescent lamp with electromagnetic ballast W	350	350	350
CFL W	300	300	300
LED 230 V W	300	300	300
halogen or LV LED with electronic ballast W	300	300	300
halogen or LV LED with electromagnetic ballast W	500	500	500
Standard contact material	AgSnO <sub>2</sub>	AgSnO <sub>2</sub>	AgSnO <sub>2</sub>

**Supply specification**

	18.51	NEW 18.51...0040	NEW 18.51...B300
Coil specification	V AC (50/60 Hz) 110...230	110...230	110...230
Rated power	VA (50 Hz)/W 1.5/1	1.5/1	1.5/1
Operating range	V AC (50/60 Hz) 96...253	96...253	96...253

**Technical data**

	18.51	NEW 18.51...0040	NEW 18.51...B300
Electrical life at rated load AC1	cycles 100 · 10 <sup>3</sup>	100 · 10 <sup>3</sup>	100 · 10 <sup>3</sup>
Ambient light intervention threshold	lx 1...500	1...500	4...1000
Light ON time after last detection	12 s...35 min	12 s...35 min	12 s...25 min
Sensing area	See diagram page 15	See diagram page 15	See diagram page 15
Ambient temperature range	°C -10...+50	-10...+50	-10...+50
Protection category	IP 40	IP 40	IP 40

**Approvals (according to type)**



- 1 NO 10 A (volt-free)
- Sensing area 360°

- 1 NO 10 A (connected to supply live)
- Sensing area 360°
- External push-button connection
- Dynamic Light Compensation

- 1 NO 10 A (volt-free)
- Sensing area 360°

**Movement and presence detectors with Push-in terminals. For internal installation.**

**Type 18.5D with DALI interface**

Three selectable functions:

- Daylight-linked constant light level control
- ON/OFF control with early warning
- ON/OFF control with early warning + courtesy light level

**Type 18.4K and 18.5K with KNX interface**

- 5 outputs (datapoint) for load control (Lighting, HVAC etc.)
- Adjustment of ambient light threshold, and PIR sensitivity
- 1 output (datapoint) – master/slave detection
- Selectable function to inhibit ambient light threshold control
- Reporting of light level and movement status (for security purposes, etc.)
- Detection of movement direction (type 18.4K)
- Internal ceiling mounting
- Suitable for ETS 4 (or latest versions)

18.5D  
Push-in terminal



18.4K/18.5K  
KNX terminal



For outline drawings see page 17

**Supply specification**

Coil specification	V AC (50/60 Hz)	110...230	—	—
Rated power	VA (50 Hz)/W	1.5/1	—	—
Operating range	V AC (50/60 Hz)	96...253	—	—

**Supply specification**

Type of BUS		—	KNX	KNX
Supply voltage	V DC	—	30	30
Rated consumption	mA	—	10	10

**Technical data**

Ambient light intervention threshold	lx	10...800	1...1500	1...1500
Light ON time after last detection		10 s...35 min	0.1 s...18 h	0.1 s...18 h
Sensing area		See diagram page 15, 16	See diagram page 15, 16	See diagram page 15, 16
Ambient temperature range	°C	-10...+50	-5...+45	-5...+45
Protection category		IP 40	IP 40	IP 40

**Approvals (according to type)**



**NEW 18.5D DALI**



- Applications: offices, schools, zones of low activity
- Suitable for direct control of up to 8 DALI lighting ballasts
- Extensive sensing area up to 64 m<sup>2</sup>
- Two sensing areas: "presence" suitable for zones of low activity, and "movement" suitable for transit areas or zones of high activity

**NEW 18.4K.9.030.0001 KNX**



- Applications: hotel and offices corridors, transit areas
- Sensing area 30 meters length and 4 meters width
- Two detection areas: right and left
- Dynamic light regulation
- Logic gates
- Up to 5 outputs

**NEW 18.5K.9.030.0001 KNX**



- Applications: offices, schools, zones of low activity
- Extensive sensing area up to 64 m<sup>2</sup>
- Dynamic light regulation
- Logic gates
- Up to 5 outputs



**Movement detectors with Push-in terminals**  
**For internal installation - with volt-free output contact**
**Type 18.41**

- Corridor (ceiling) installation

- Extensive sensing area up to 120 m<sup>2</sup>
- Modern design
- Quick installation thanks to push-in terminals
- 1 NO contact 10 A, with "zero crossing" switching
- Double terminals for easy "looping" in and out

 18.41  
 Push-in terminal

NOTE: with 110...125 V AC supply, the Ratings (AC1, AC15 and lamp loads) must be reduced by 50 % (e.g. 500 W instead of 1000 W)

For outline drawings see page 17

**Contact specification**

Number of contacts		1 NO (SPST-NO)
Rated current/Maximum peak current	A	10/20 (100 A - 5 ms)
Rated voltage/ Maximum switching voltage	V AC	250/400
Rated load AC1	VA	2500
Rated load AC15	VA	450
Nominal lamp rating 230 V:		
incandescent/halogen W		1000
fluorescent lamp with electronic ballast W		500
fluorescent lamp with electromagnetic ballast W		350
CFL W		300
LED 230 V W		300
halogen or LV LED with electronic ballast W		300
halogen or LV LED with electromagnetic ballast W		500

Standard contact material		AgSnO <sub>2</sub>
---------------------------	--	--------------------

**Supply specification**

Coil specification	V AC (50/60 Hz)	110...230
Rated power	VA (50 Hz)/W	1.5/1
Operating range	V AC (50/60 Hz)	96...253

**Technical data**

Electrical life at rated load AC1	cycles	100 · 10 <sup>3</sup>
Ambient light intervention threshold	lx	1...500
Light ON time after last detection		12 s...35 min
Sensing area		See diagram page 15
Ambient temperature range	°C	-10...+50
Protection category		IP 40

**Approvals** (according to type)

**18.41**

- 1 NO 10 A
- Applications: hotel and offices corridors, transit areas
- Sensing area 30 meters length and 4 meters width



**Movement detectors for internal installation**

**Type 18.91**

- Wall mount installation
- External push-button connection
- Modern design
- 1 output with “zero crossing” switching
- Wall mounting compatible with 3 module housing, complete with adaptor for following frames:
  - Ave S44
  - BTicino series Axolute
  - BTicino series Living
  - BTicino series Living Light
  - BTicino series Living Light Air
  - BTicino series Matix
  - Gewiss series Chorus
  - Gewiss series System
  - Simon Urmet Nea
  - Vimar series Eikon
  - Vimar series Idea
  - Vimar series Arkè
  - Vimar Plana
- White or black versions

**NEW 18.91**



- Specifically for wall mounting
- Wide angle: 110°
- Applications: corridors, transit areas, toilets, staircases

18.91  
Screw terminal



For outline drawings see page 18

Output data		
Rated voltage	V AC	230
Power max.	W	200
Power min.	W	3
Nominal lamp rating 230 V:		
incandescent/halogen W		200
toroidal electromagnetic transformers for LV halogen W		200
E-core electromagnetic transformers for LV halogen W		200
electronic transformers (ballasts) for LV halogen W		200
compact fluorescent (CFL) W		200
230 V LED W		200
electronic transformers for LV LED W		200
Supply specification		
Nominal voltage (U <sub>N</sub> )	V AC (50/60 Hz)	230
Rated power	VA(50Hz)/W	14/0.5
Operating range		(0.8...1.1)U <sub>N</sub>
Technical data		
Ambient light intervention threshold	lx	5...500 (black)/6...600 (white)
Light ON time after last detection		10 s...20 min
Sensing area		See diagram page 15
Ambient temperature range	°C	-10...+50
Protection category		IP 20
<b>Approvals</b> (according to type)		

### Ordering information

Example: 18 series, PIR movement detector for internal installations, wall mounting, 1 NO 10 A contact, 120...230 V AC supply.



**Series**

- Type**
- 0 = Internal installation - wall mounting
  - 1 = External installations
  - 2 = Internal ceiling installation - surface mounting
  - 3 = Internal ceiling installation - recessed mounting
  - 4 = PIR movement detector for corridors
  - 5 = PIR movement and presence detector
  - 9 = PIR movement detector wall mounting residential switch boxes
  - A = External installations IP 55, push-in terminals

**Program**

- 0 = Standard
  - B = Bluetooth programming
- Contact circuit**
- 0 = Voltage output
  - 3 = Volt-free output contact

**Supply voltage**

- 024 = 24 V AC/DC for types 18.21/31-0300 only
- 030 = KNX Bus
- 230 = 120...230 V for types 18.01, 18.11, 18.21, 18.31
- 230 = 110...230 V for types 18.A1, 18.41, 18.51, 18.51.B300, 18.5D
- 230 = 230 V for type 18.91

**Supply version**

- 0 = AC (50/60 Hz)/DC (24 V only)
- 8 = AC (50/60 Hz)
- 9 = DC

**No. of poles/Output**

- 1 = Single pole switching 1 NO (SPST-NO), 10 A
- D = PIR movement and presence detector with DALI interface
- K = PIR movement and presence detector with KNX interface

**Special version**

- 01 = Dynamic light regulation
- 31 = High ceilings, (30 s...35 min)
- 40 = Push-button connection (only 18.51)
- 40 = Push-button connection, white (only 18.91)
- 42 = Push-button connection, black (only 18.91)

**Codes**

18.01.8.230.0000	18.31.0.024.0300	18.41.8.230.0300
18.11.8.230.0000	18.31.8.230.0000	18.51.8.230.0300
18.21.0.024.0300	18.31.8.230.0300	18.51.8.230.0040
18.21.8.230.0000	18.31.8.230.0031	18.51.8.230.B300
18.21.8.230.0300		18.91.8.230.0040
		18.91.8.230.0042
		18.A1.8.230.0000
		18.5D.8.230.0000
		18.4K.9.030.0001
		18.5K.9.030.0001

## Technical data

Insulation					
Dielectric strength between open contacts		V AC	1000 (except for type 18.91 TRIAC output)		
Between supply and contact		V AC	1500 (types 18.21...0300, 18.31...0300, 18.41, 18.51)		
EMC specifications					
Type of test		Reference standard			
Electrostatic discharge	contact discharge	EN 61000-4-2	4 kV		
	air discharge	EN 61000-4-2	8 kV		
Radiated electromagnetic field (80...2000 MHz)		EN 61000-4-3	3 V/m		
Fast transients (burst 5/50 ns, 5 and 100 kHz)	on supply terminals	EN 61000-4-4	1 kV		
Voltage pulses on supply terminals (surge 1.2/50 µs)	common mode	EN 61000-4-5	4 kV (2 kV for 18.91)		
	differential mode	EN 61000-4-5	4 kV (2.5 kV for 18.01/11, 1 kV for 18.91)		
Radiofrequency common mode voltage (0.15...230 MHz)	on supply terminals	EN 61000-4-6	3 V		
Voltage dips	70% U <sub>N</sub> , 40% U <sub>N</sub>	EN 61000-4-11	10 cycles		
Short interruptions		EN 61000-4-11	10 cycles		
Radiofrequency conducted emissions (0.15...30)MHz		EN 55014	class B		
Radiated emissions (30...1000)MHz		EN 55014	class B		
Terminals			<b>18.01, 18.11, 18.21, 18.31, 18.91</b>		<b>18.41, 18.51, 18.51...B300, 18.A1</b>
Type		Screw terminal	Push-in (see pag. 19)		
Screw torque		Nm	0.5		—
Max. wire size	mm <sup>2</sup>	solid cable	stranded cable	solid cable	stranded cable
		1 x 6 / 2 x 4	1 x 4 / 2 x 2.5	2.5	2.5
		AWG 1 x 10 / 2 x 12	1 x 12 / 2 x 14	14	14
Wire strip length	mm	9	9	8	8
Other data					
Power lost to the environment	without output current	W	0.3		
	with rated output current	W	1.4		
Cable grip (type 18.11)		∅ mm	(8.9...12)		

Following the initial power-on, and power-on following a power interruption, the detector makes a hardware-software initialisation for approximately 30 seconds.

The behaviour of the output during this period can vary depending on the product type, and in some cases on the state of the detector before the power interruption and on the lighting level.



Wiring diagram

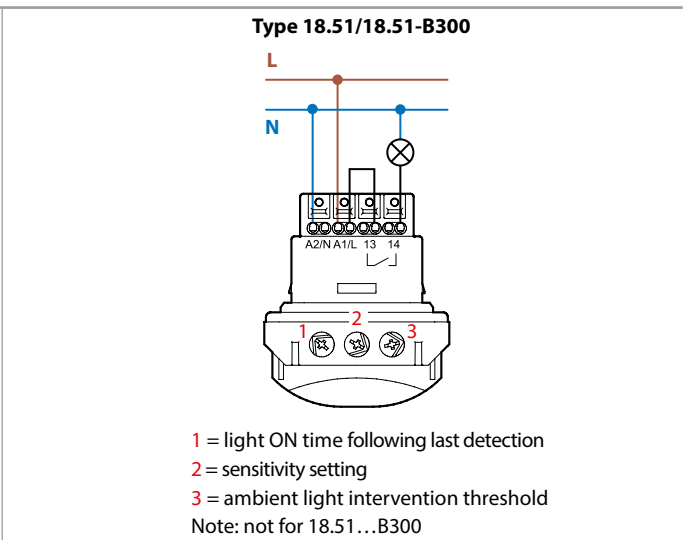
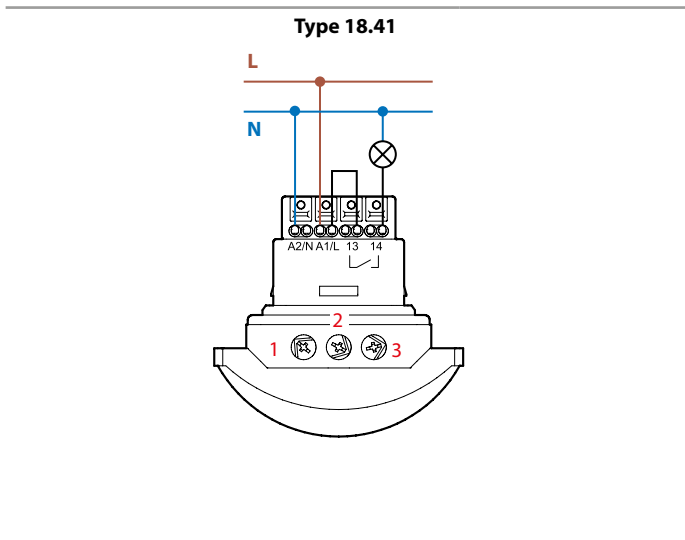
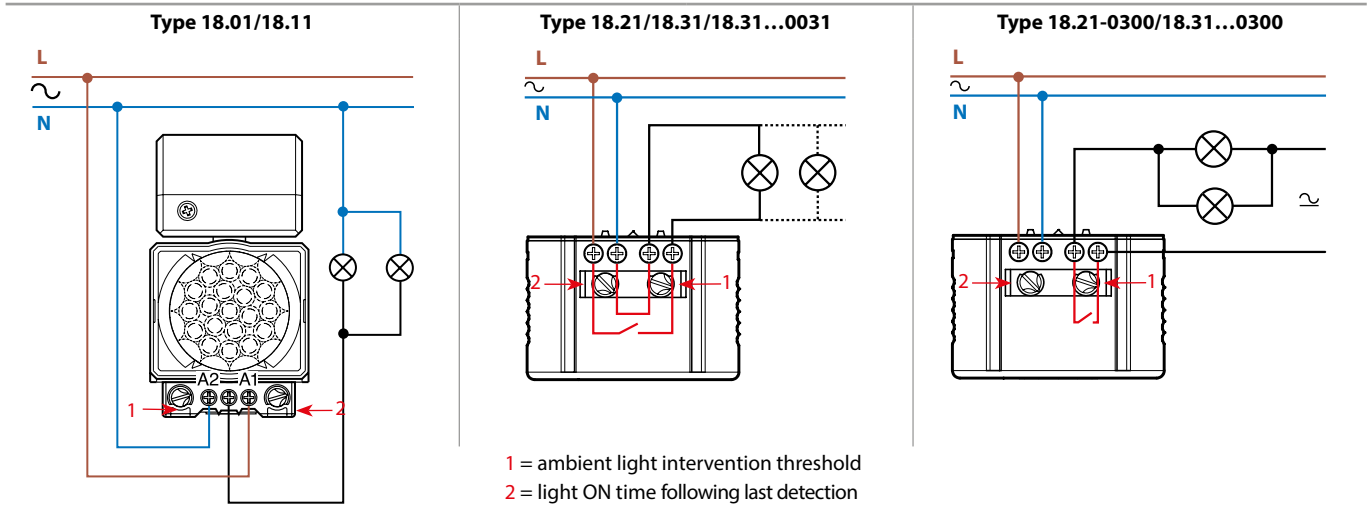

The nominal lamp rating as stated in the contact specification applies when wiring is realized in accordance with the diagrams above.  
If the load is powered from a phase different to that powering the Movement detector, then a 50% reduction in the lamp rating must be considered.

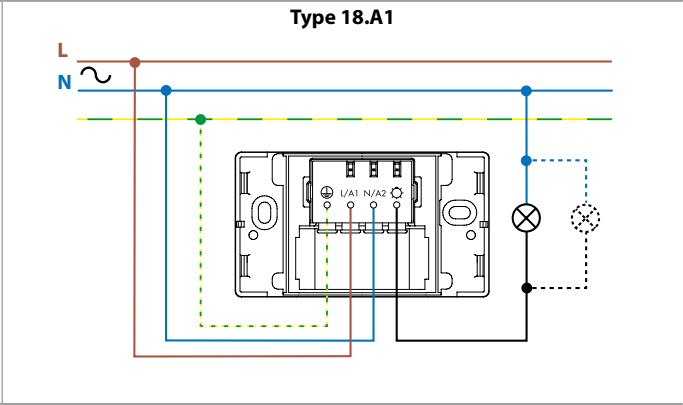
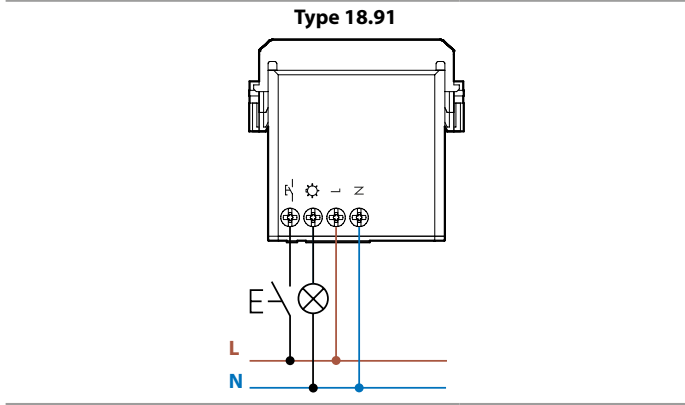
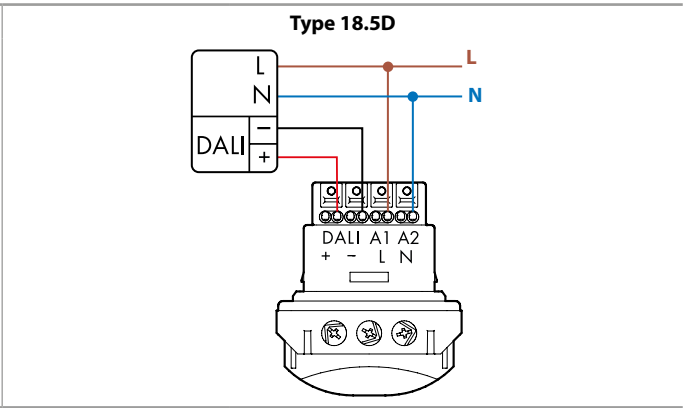
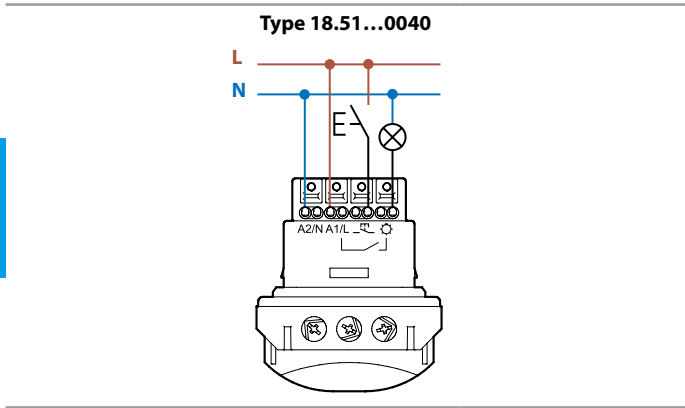

### Wiring diagram

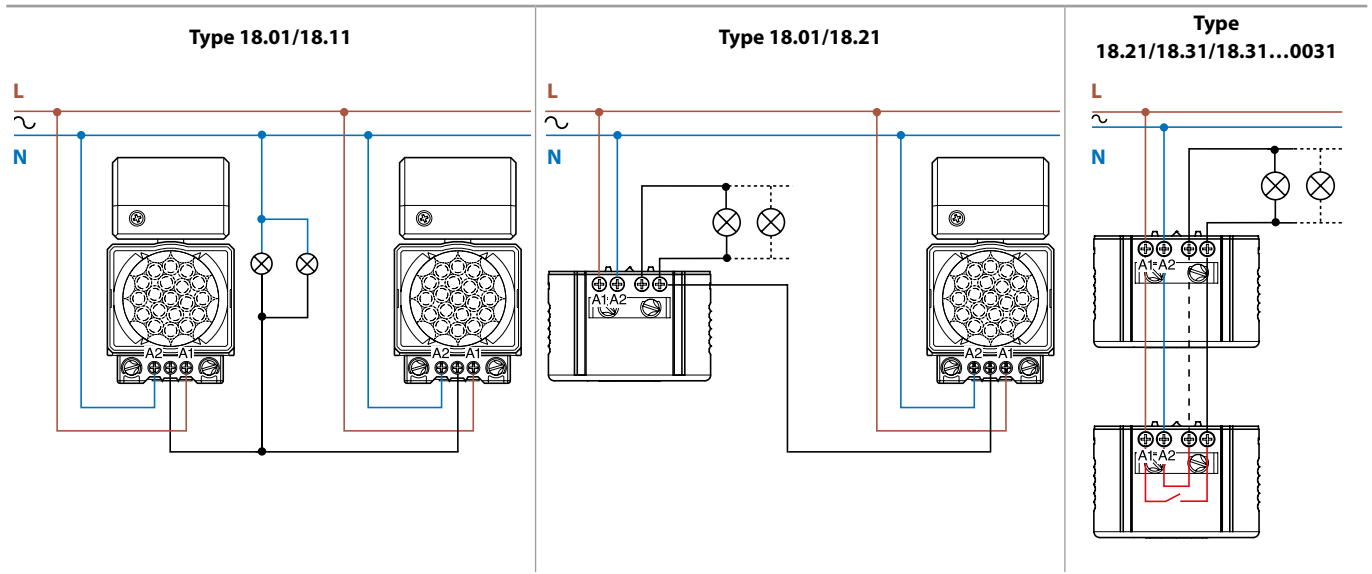

**Note: Observe the polarity indicated for Phase and Neutral**

### Type 18.51-B300 - Bluetooth

Through the use of Bluetooth LE (Low Energy) technology programming the detector's operating characteristics can be easily and conveniently done using an Android or iOS smartphone.

After installing the 18.51, simply download the Free **App Finder Toolbox** from Google and Apple's official stores and set all the required parameters.



Finder Toolbox

Android, Google Play and the Google Play logo are trademarks of Google Inc.  
Apple is a trademark of Apple Inc. App Store is a service mark of Apple Inc.

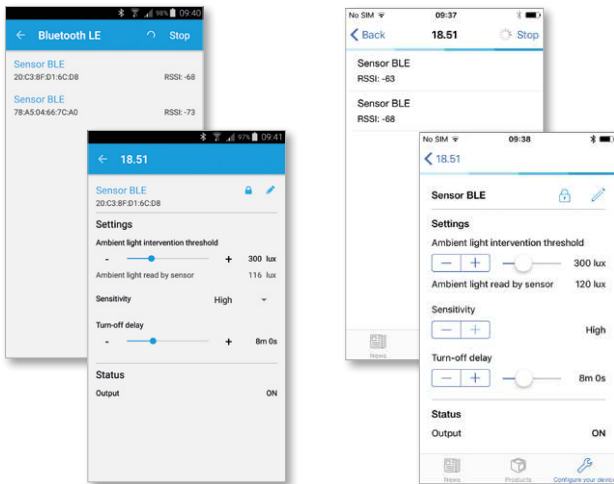

Detectors can be named and uniquely identified within a building. The ambient light level threshold can be adjusted between 4 lux and 1000 lux, the Light On delay time can be set from 12 seconds to 25 minutes, and the movement detector set to one of three sensitivity levels. When Bluetooth connection is made to a detector a red LED signals the correct pairing and that all the set parameters have been transferred. The detector then responds with two feedback values - brightness as read by the light sensor in the detector and the contact status, if closed (On) or open (Off). For security, the detectors can be locked by a selector switch and a 4-digit PIN - preventing parameter changes by unauthorized persons.



Functions

Type Functions

18.51...0040

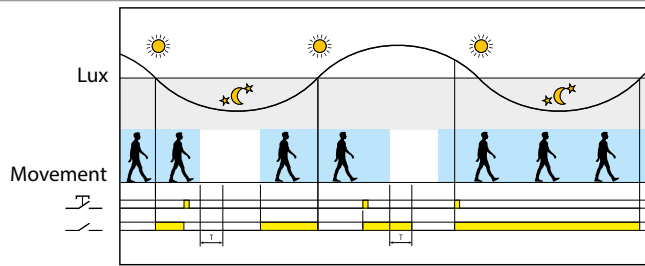

**Push-button function**

A control pulse on the push-button inverts the status of the output relay, until the timing after the last movement detected is elapsed.

**Dynamic Light Compensation**

By incorporating Finder's Patented "light feedback compensation" principle, the 18.51...0040 is able to calculate the artificial light contributed by the lamps controlled by the output relay. In effect, this means the 18.51...0040 is able to continuously monitor the natural ambient light level, even when the output is On. As a consequence, whenever the natural light level exceeds the threshold setting the output is forced Off. This can significantly minimise the time the lighting is On, particularly where there is a high level of traffic - and cost savings can be considerable. This is an advance over other types of movement detectors, which are unable to identify the natural ambient light level when the output is On and so can only turn Off after the time delay that follows the last detected movement. In busy areas this may mean that the movement detector is being continuously re-triggered and maintained in the On state, even though the natural light level has long risen above the threshold.

18.5D

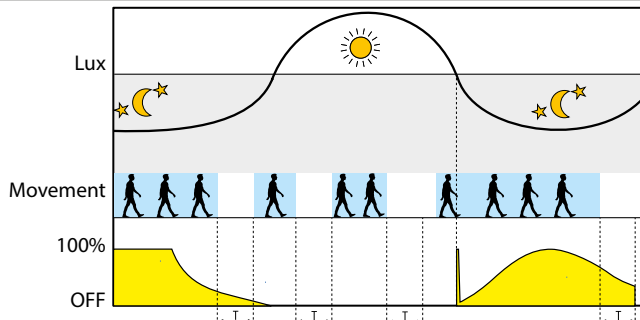

**Comfort - Daylight-linked constant light level control**

Adjusts to maintain a constant brightness level considering the detection of movement and the level of daylight - increasing or decreasing the power of the artificial light as appropriate. Suitable for small offices, classrooms or workplaces. This allows considerable energy saving while maintaining a comfortable level of illumination.

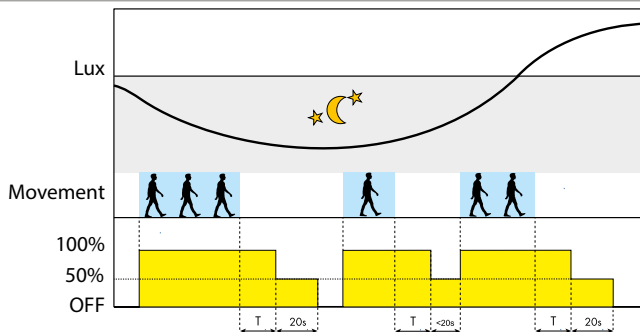

**Simplicity - ON/OFF control with early warning**

Works as a simple movement detector, activating the lamps at 100% power. But provides an early warning of the next shutdown with a power reduction to 50% for 20 seconds. Avoids a sudden total shutdown of lighting.

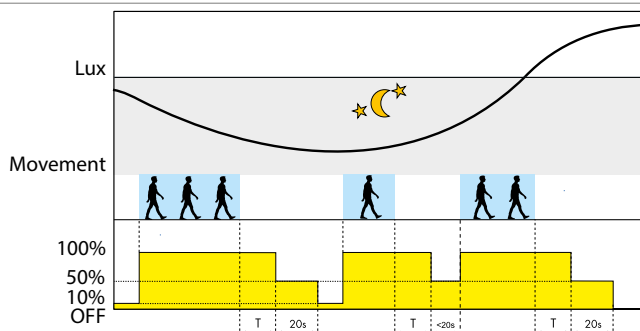

**Courtesy - ON/OFF control with early warning + courtesy light level**

If the brightness level is lower than the set value, artificial light is maintained at 10% power, guaranteeing a minimum level of illumination at all times. When movement is detected, the power of the lamps is raised to 100%. There is an early warning of any reduction from the 100% power level by a reduction to 50% for 20 seconds. Suitable for common areas, lobbies, corridors, elevator zones.

18.91

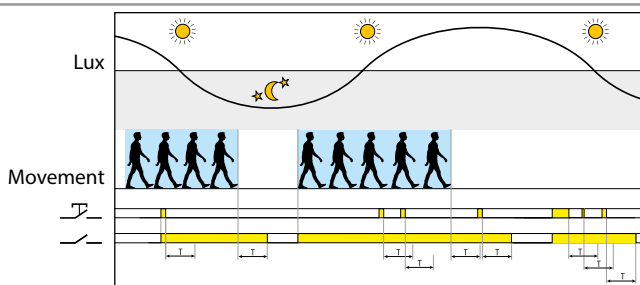

**Detection of movement**

Detected movement closes, or keeps closed, the output contact. Operating the push-button closes, or keeps closed, the output contact - for the set time T.

Sensing area

18.01, 18.11, 18.A1 - Wall mounting

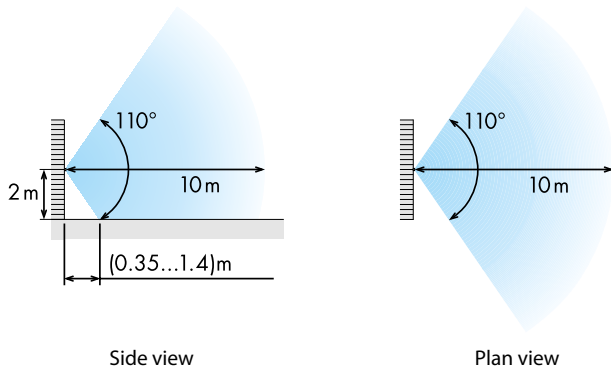

18.01, 18.11 - Ceiling mounting

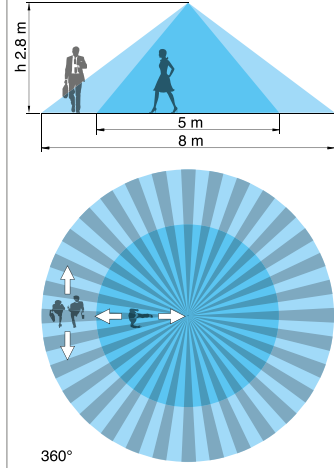

18.21, 18.31 - Ceiling mounting

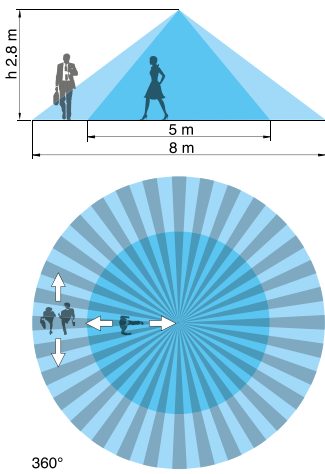

18.31.8.230.0000/18.21.8.230.0000  
- Ceiling mounting

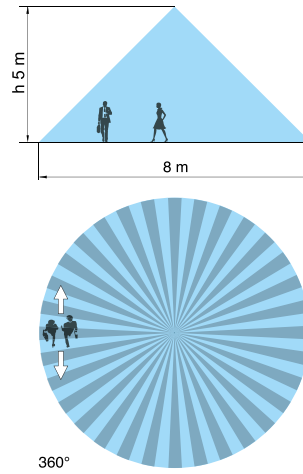

18.31...0031 - Internal ceiling installation,  
surface mounting

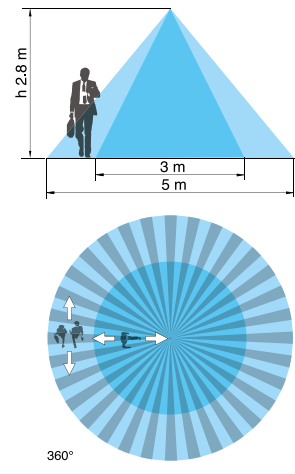

18.31...0031 - High ceilings installations

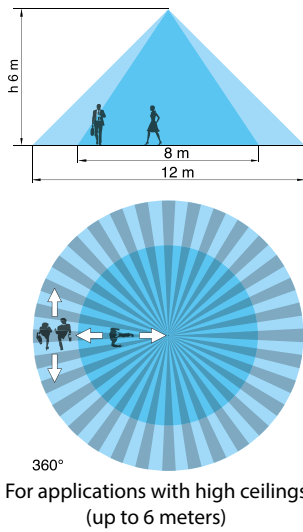

18.41/18.4K

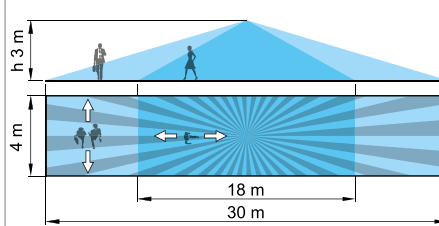

18.91

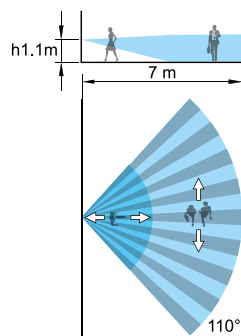

18.51/18.51...B300/18.5K/18.5D

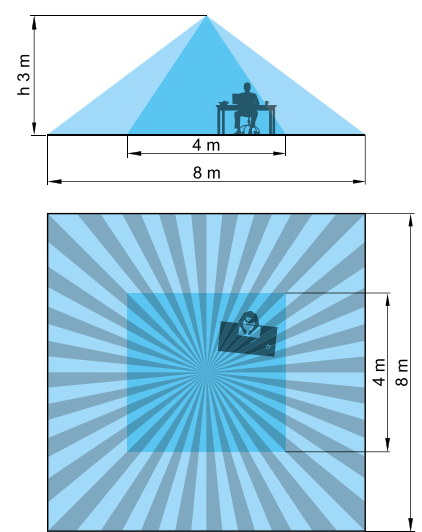

## Sensing area

18.51/18.51...B300/18.5K/18.5D

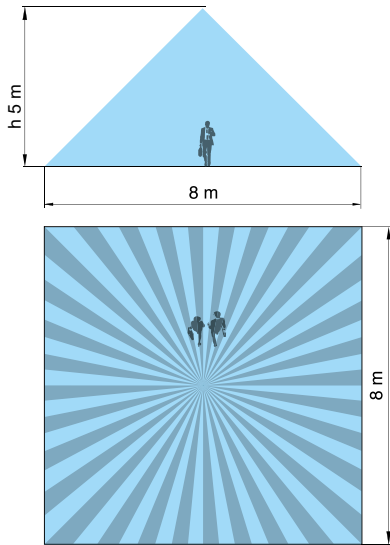

## Accessories

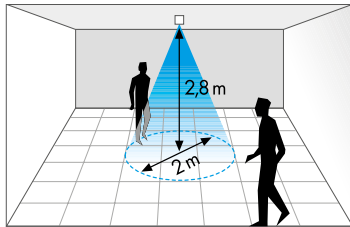

Example: 18.21/18.31 with Beam limiter

### Beam limiter (supplied with the types 18.21/31/41/51)

At an installation height of 2.8 meters the area of survey will reduce at:  
 18.21/18.31: diameter 2 meters  
 18.41: 2.5 x 6 meters  
 18.51: 2 x 2 meters



Outline drawings

Type	Suspended ceiling mounting	Recess mounting	Surface mounting
18.21			
18.31			
18.31...0031			
18.41			
18.51 18.5D 18.51...B300			
18.4K			
18.5K			

Outline drawings

Type 18.01

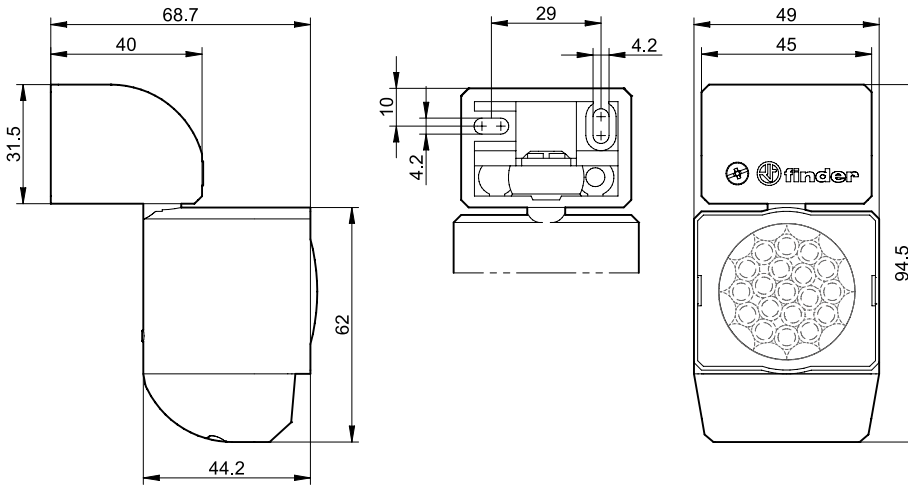

Type 18.11

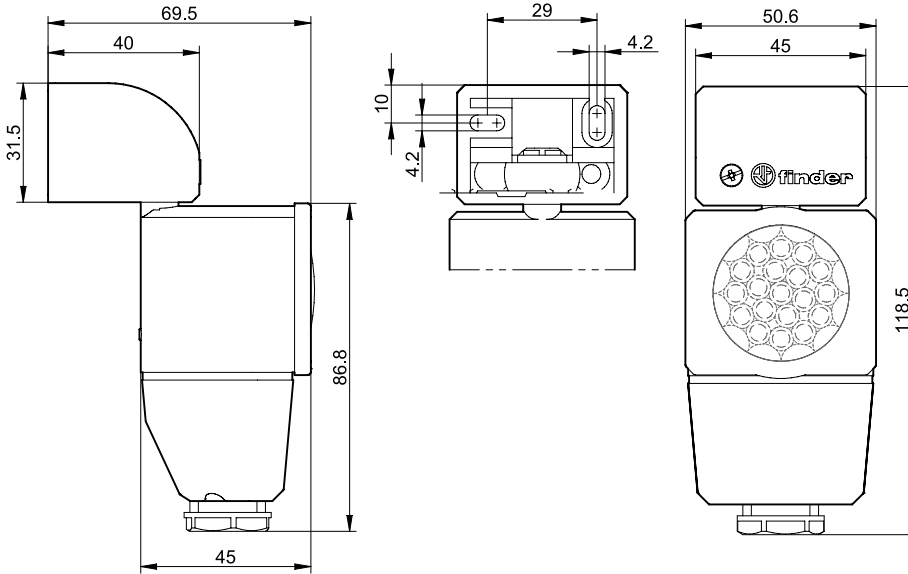

Type 18.A1

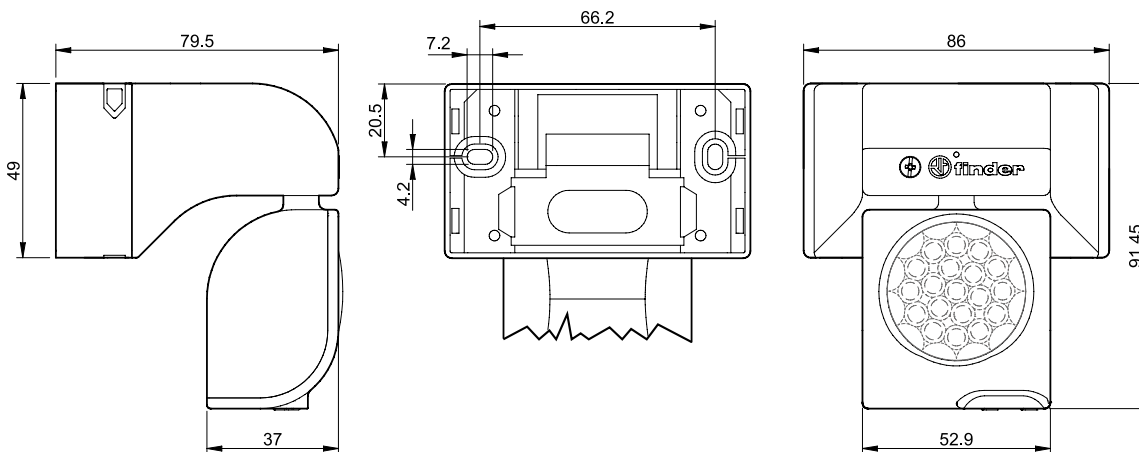

Type 18.91

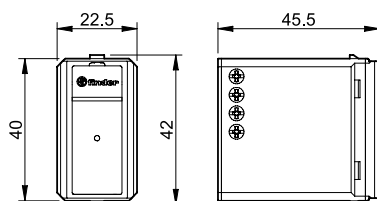

### Push-in terminals for 18.41, 18.51, 18.5D and 18.A1

The push-in terminals permit the quick connection of solid wires or ferrules by their simple insertion into the terminal (A). It is possible to open the terminal to extract the wire by first pushing down on the push-button using a screwdriver or fingers (C). For stranded cable it is necessary first to open the terminal using the push button, both for the extraction (C) and insertion (B).

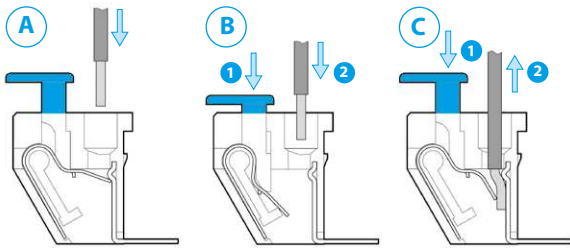

Double terminals for the easy "looping" between multiple 18 Series.  
The Max. wire size for each terminal is 2.5 mm<sup>2</sup>.

The terminals are equipped with a test hole to take a test probe.



# LED emergency light “LUMOS”



Emergency  
lighting

**1L**  
SERIES



**LED emergency light "LUMOS"**

**Type 1L.10**

**- Wall mount installation**

- Complies with CEI 64-8
- Nominal voltage: 230 V AC (50/60)Hz
- Rechargeable battery
- Battery run time 2.5 hours
- Modern design
- Wall mounting compatible with 3 module housing, complete with adaptor for following frames:
  - Ave series S44
  - BTicino series Axolute
  - BTicino series Living
  - BTicino series Living Light
  - BTicino series Living Light Air
  - BTicino series Matix
  - Gewiss series Chorus
  - Gewiss series System
  - Simon Urmet Nea
  - Vimar series Eikon
  - Vimar series Idea
  - Vimar series Arkè
  - Vimar Plana
- White or black color version

**1L.10**



- This emergency lighting module activates in the event of a failure of the lighting supply

1L.10  
Screw terminal



For outline drawing see page 4

Technical data		
Luminous flux	Lumens	14
Efficiency	Lumens/Watt	67
Time to fully charge the battery	h	72
Maximum illumination time (assuming fully charged battery)	h	2.5
Color temperature	k	5700
Supply specification		
Nominal voltage (U <sub>N</sub> )	V AC (50/60 Hz)	110...230
Operating range	V AC (50/60 Hz)	88...264
Power consumption	W	0.2
Technical data		
Ambient temperature range	°C	-10...+50
Protection category		IP 20
<b>Approvals</b> (according to type)		<b>CE UK EAC</b>

J

### Ordering information

Example: 1L series, LED emergency light, 230 V AC supply.

**1 L . 1 0 . 8 . 2 3 0 . 0 0 0 0**

**Series**  
**Type**  
10 = LED emergency light

**Supply voltage**  
230 = 110...230 V  
**Supply version**  
8 = AC (50/60 Hz)

**Color**  
0 = White  
2 = Anthracite gray

### Wiring diagrams

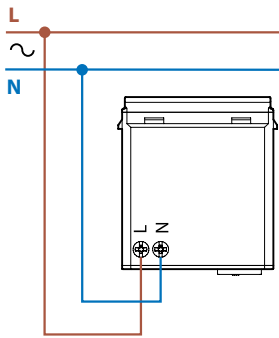

#### PUTTING INTO SERVICE

After carrying out the connection and before proceeding with closure of the wall box move the selector from position 0 to 1.

With this setting the Lamp will turn on when power is OFF and will turn off with the power supply present.

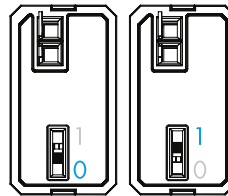

### Polar diagram

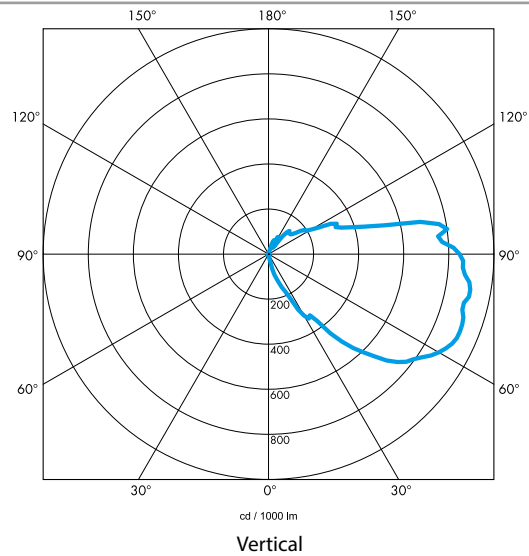
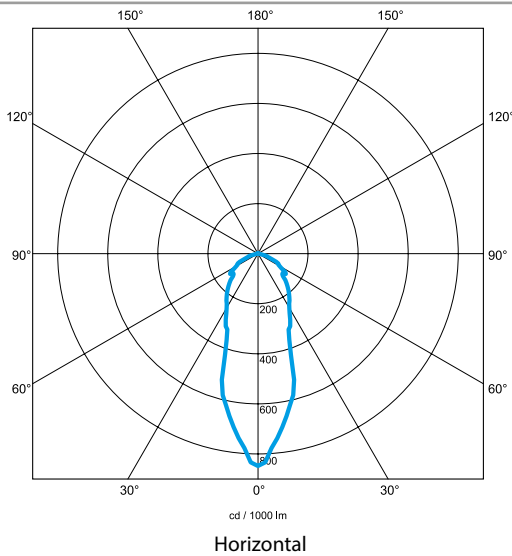

### Adaptor

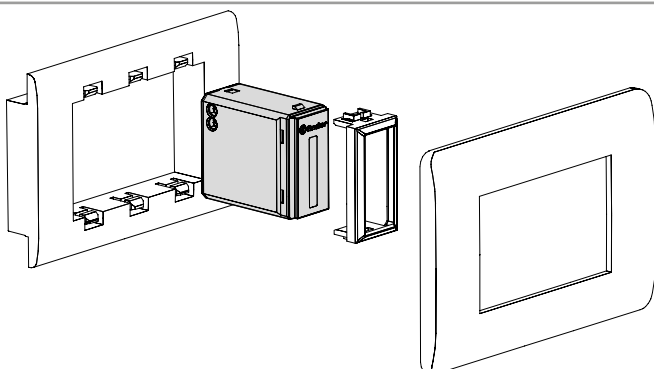

### Outline drawings

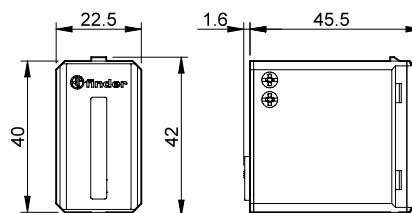



# Electronic Relays and Actuators: Multi and Single Function



Call and reset switches for bathrooms



Bathroom lighting control



Bedroom light control



Living room light control



Office lighting control



Remote climate control



13  
SERIES



**13.81 - Quiet electronic step relay - Rail mount - 1 Pole**

**13.91 - Quiet electronic step relay and timing step relay Switch box mount - 1 Pole**

- Fixed time (10 minutes) timing function selectable (13.91)
- Use with 3 or 4 wire connection, with automatic recognition by the relay
- Control input can be continuously applied
- Longer mechanical and electrical life, and much quieter than electromechanical step relays
- "Zero crossing" load switching
- Can be mounted behind blanking plates, as widely used in residential wiring systems such as; BTicino: Axolute, Matix, Living and Magic, Gewiss: GW24, Vimar: Plana and Idea ... (13.91)
- 35 mm rail (EN 60715) mount (13.81)
- Cadmium free contact material

13.81/91

Screw terminals



For outline drawing see page 19, 20

**Contact specification**

Contact configuration		1 NO (SPST-NO)	1 NO (SPST-NO)
Rated current/Maximum peak current	A	16/30 (120 - 5 ms)	10/20 (80 - 5 ms)
Rated voltage/ Maximum switching voltage	V AC	230/—	230/—
Rated load AC1	VA	3700	2300
Rated load AC15 (230 V AC)	VA	750	450
Nominal lamp rating:			
230 V incandescent/halogen W		3000	1000
fluorescent tubes with electronic ballast W		1500	500
fluorescent tubes with electromagnetic ballast W		1000	350
CFL W		600	300
230 V LED W		600	300
LV halogen or LED with electronic ballast W		600	300
LV halogen or LED with electromagnetic ballast W		1500	500
Minimum switching load	mW (V/mA)	1000 (10/10)	1000 (10/10)
Standard contact material		AgSnO <sub>2</sub>	AgSnO <sub>2</sub>

**Supply specification**

Nominal voltage (U <sub>N</sub> )	V AC (50/60 Hz)	230	230
	V DC	—	—
Rated power	VA (50 Hz)/W	3/1.2	2/1
Operating range	AC (50 Hz)	(0.8...1.1)U <sub>N</sub>	(0.8...1.1)U <sub>N</sub>
	DC	—	—

**Technical data**

Electrical life at rated load in AC1	cycles	100 · 10 <sup>3</sup>	100 · 10 <sup>3</sup>
Maximum impulse duration		continuous	continuous
Dielectric strength between:			
open contacts V AC		1000	1000
supply - contacts V AC		—	—
Ambient temperature range	°C	-10...+60	-10...+50
Protection category		IP 20	IP 20

**Approvals** (according to type)



**13.81**



- 1 NO (SPST-NO)
- 35 mm rail (EN 60715) mount
- 17.5 mm wide

**13.91**



- 1 NO (SPST-NO)
- Step relay and timing step relay (10 minutes)
- For mounting within residential switch boxes

**13.01 - Electronic step  
Bistable or monostable relay**
**13.61 - Electronic step  
Multifunction step relay  
Reset feature (13.61.8.230.0000)  
Set and Reset feature (13.61.0.024.0000)**

- Control input can be continuously applied
- Longer mechanical and electrical life, and much quieter than electromechanical step relays
- 35 mm rail (EN 60715) mount
- Cadmium free contact material
- Selectable Step or Monostable operation (13.01)
- Suitable for SELV applications and available also for supply 12 and 24 V AC/DC (13.01)
- Multifunction: Step, Timing step, Monostable, Light ON (13.61)
- 12...24 V AC/DC and 110...240 V AC supply versions (13.61)
- Reset feature, for centralized off command (13.61.8.230.0000)
- Set feature, for centralized on command
- Reset feature, for centralized off command (13.61.0.024.0000)
- "Zero-crossing" load switching (13.61)

13.01/61

Screw terminals



\* With DC Bistable function: (12...13.2)V DC

For outline drawing see page 19

**Contact specification**

Contact configuration		1 CO (SPDT)	1 CO (SPDT)	1 NO (SPST-NO)
Rated current/Maximum peak current	A	16/30 (120 A - 5 ms)	16/30 (120 A - 5 ms)	16/30 (120 A - 5 ms)
Rated voltage/ Maximum switching voltage	V AC	250/400	250/400	250/400
Rated load AC1	VA	4000	4000	4000
Rated load AC15 (230 V AC)	VA	750	750	750
Nominal lamp rating:				
230 V incandescent/halogen W		2000	2000	3000
fluorescent tubes with electronic ballast W		1000	1000	1500
fluorescent tubes with electromagnetic ballast W		750	750	1000
CFL W		400	400	600
230 V LED W		400	400	600
LV halogen or LED with electronic ballast W		400	400	600
LV halogen or LED with electromagnetic ballast W		800	800	1500
Minimum switching load	mW (V/mA)	1000 (10/10)	1000 (10/10)	1000 (10/10)
Standard contact material		AgSnO <sub>2</sub>	AgSnO <sub>2</sub>	AgSnO <sub>2</sub>

**Supply specification**

Nominal voltage (U <sub>N</sub> )	V AC (50/60 Hz)	110...125	230...240	—	110...240
	V DC/AC (50/60 Hz)	12	24	12...24	—
Rated power AC/DC	VA (50/60 Hz)/W	2.5/2.5		1/0.5	3.2/1
Operating range	V AC (50/60 Hz)	90...130	184...253	—	90...264
	V DC/AC (50/60 Hz)	10.8*...13.2	20.6...33.6	10.2...26.4	—

**Technical data**

Electrical life at rated load in AC1	cycles	100 · 10 <sup>3</sup>	100 · 10 <sup>3</sup>	100 · 10 <sup>3</sup>
Maximum impulse duration		continuous	continuous	continuous
Dielectric strength between:	open contacts V AC	1000	1000	1000
	supply - contacts V AC	4000	2000	2000
Ambient temperature range	°C	-10...+60	-10...+60	-10...+60
Protection category		IP 20	IP 20	IP 20

**Approvals (according to type)**

**13.01**

- 1 CO (SPDT)
- Step or monostable relay
- According to EN 60601-1 2 x MOOP
- 35 mm rail (EN 60715) mount
- 35 mm wide

**13.61.0.024.0000**

- 1 CO (SPDT)
- Reset feature, for centralized off command
- Set feature, for centralized on command
- Multifunction:
  - step relay
  - timing step relay (30s...20min)
  - monostable relay
  - light on
- 35 mm rail (EN 60715) mount
- 17.5 mm wide

**13.61.8.230.0000**

- 1 NO (SPST-NO)
- Reset feature, for centralized off command
- Multifunction:
  - step relay
  - timing step relay (30s...20min)
  - monostable relay
  - light on
- 35 mm rail (EN 60715) mount
- 17.5 mm wide

- 13.11 - Call & Reset Relay - Rail mount - 1 Pole**
- 13.12 - Call & Reset Relay - Rail mount - 2 Pole**
- 13.31 - Electromechanical monostable relay  
Switch box mount - 1 Pole**

- Call relay with reset command suitable for residential and commercial applications: public bathroom, hospital, hotel (type 13.11/13.12)
- Can be mounted behind blanking plates, as widely used in residential wiring systems such as; BTicino: Axolute, Matix, Living e Magic, Gewiss: GW24, Vimar: Plana e Idea ... (13.31)
- 35 mm rail (EN 60715) or flange mount (13.11 and 13.12)
- Cadmium free contact material

13.11/12/31  
Screw terminals



\* During impulse only.  
For outline drawing see page 19

**Contact specification**

Contact configuration	1 CO (SPDT)	1 CO (SPDT) + 1 NO (SPST-NO)	1 NO (SPST-NO)
Rated current/Maximum peak current A	12/30	8/15	12/20 (80 A - 5 ms)
Rated voltage/ Maximum switching voltage V AC	250/400	250/400	250/400
Rated load AC1 VA	3000	2000	3000
Rated load AC15 (230 V AC) VA	750	400	450
Nominal lamp rating:			
230 V incandescent/halogen W	—	—	800
fluorescent tubes with electronic ballast W	—	—	400
fluorescent tubes with electromagnetic ballast W	—	—	300
CFL W	—	—	200
230 V LED W	—	—	200
LV halogen or LED with electronic ballast W	—	—	200
LV halogen or LED with electromagnetic ballast W	—	—	400
Minimum switching load mW (V/mA)	500 (5/5)	300 (5/5)	1000 (10/10)
Standard contact material	AgNi	AgNi	AgSnO <sub>2</sub>

**Supply specification**

Nominal voltage (U <sub>N</sub> )	V AC (50/60 Hz)	230...240	12 - 24	12 - 230
	V DC	—	12 - 24	24
Rated power AC/DC	VA (50 Hz)/W	1.7/0.7*	3/2.5*	1/0.4
Operating range	AC (50 Hz)	(0.8...1.1)U <sub>N</sub>	(0.8...1.1)U <sub>N</sub>	(0.8...1.1)U <sub>N</sub>
	DC	—	(0.8...1.1)U <sub>N</sub>	(0.8...1.1)U <sub>N</sub>

**Technical data**

Electrical life at rated load in AC1	cycles	100 · 10 <sup>3</sup>	100 · 10 <sup>3</sup>	70 · 10 <sup>3</sup>
Maximum impulse duration		10 s (100 ms minimum)	10 s (100 ms minimum)	continuous
Dielectric strength between:	open contacts V AC	1000	1000	1000
	supply - contacts V AC	2000	2000	2000
Ambient temperature range	°C	-10...+60	-10...+60	-10...+60
Protection category		IP 20	IP 20	IP 20

**Approvals** (according to type)



13.11

- 1 CO (SPDT)
- Call relay with reset command
- 35 mm rail (EN 60715) mount
- 17.5 mm wide



13.12

- 1 CO (SPDT) + 1 NO (SPST-NO)
- Call relay with reset command
- 35 mm rail (EN 60715) mount
- 17.5 mm wide



13.31

- 1 NO (SPST-NO)
- Interposing monostable relay
- For mounting within residential switch boxes

**Multi and Single function electronic relays with Bluetooth**

**13.22 - Electronic multifunction relay 2 Pole**

- Round wall box (ie: Ø 60 mm) mounting
- 21 available functions (step relays, timer, staircase timer) for lighting and fan motor control

**13.72 - Electronic multifunction relay 2 Pole**

- Wall mounting, compatible with most popular Italian residential switch boxes: AVE, BTicino, Gewiss, Simon-Urmet, Vimar
- 21 available functions: step relays, timing (1s - 24h), electric shutter, blind or curtain control

**13.S2 - Electronic roller shutter actuator**

- Round wall box (ie: Ø 60 mm) mounting
- For electric shutter, blind or curtain control
- 2 contacts NO 6 A - 230 V AC independent and programmable channels
- 2 inputs for wired pushbuttons (one input per channel)
- Transmission range: approximately 10 m in free space and without obstacles

13.22/S2/72  
Screw terminals



NOTE: with 110...125 V AC supply, the Ratings (AC1, AC15 and lamp loads) must be reduced by 50 % (e.g. 100 W instead of 200 W)

For outline drawing see page 20

**Contact specification**

Contact configuration		2 NO (DPST-NO)	2 NO (DPST-NO)	2 NO (DPST-NO)
Rated current/Maximum peak current	A	6/40	6/40	6/40
Rated voltage/Maximum switching voltage	V AC	230/—	230/—	230/—
Rated load AC1	VA	1380	1380	1380
Rated load AC15 (230 V AC)	VA	300	300	300
Single phase motor rating (230 V AC)	W	200	200	200
Nominal lamp rating 230V:				
incandescent/halogen W		200	200	—
fluorescent tubes with electronic ballast W		200	200	—
fluorescent tubes with electromagnetic ballast W		200	200	—
CFL W		200	200	—
LED 230 V W		200	200	—
LV halogen or LED with electronic ballast W		200	200	—
LV halogen or LED with electromagnetic ballast W		200	200	—

**Supply specification**

Nominal voltage (U <sub>N</sub> )	V AC (50/60 Hz)	110...230	110...230	110...230
	V DC	—	—	—
Rated power AC/DC	VA (50 Hz)/W	2 / 0.5	2 / 0.5	2 / 0.5
Operating range	AC (50 Hz)	(0.8...1.1)U <sub>N</sub>	(0.8...1.1)U <sub>N</sub>	(0.8...1.1)U <sub>N</sub>
	DC	—	—	—

**Technical data**

Electrical life at rated load in AC1	cycles	60 · 10 <sup>3</sup>	60 · 10 <sup>3</sup>	60 · 10 <sup>3</sup>
Maximum impulse duration		continuous	continuous	continuous
Dielectric strength between: open contacts	V AC	1000	1000	1000
Ambient temperature range	°C	-10...+50	-10...+50	-10...+50
Protection category		IP 20	IP 20	IP 20

**Approvals (according to type)**



- Offering a variety of ON/OFF functions associated with lighting and fan motor control
- Transmission protocol Bluetooth Low Energy (BLE)
- Safe connection with 128-bit encryption
- App programming with iOS or Android Smartphone: Finder YOU
- Can be managed through standard pushbuttons, BEYON and Type 013.B9 wireless buttons

- Offering a variety of ON/OFF functions associated with lighting, electric shutters, blinds or curtains
- Transmission protocol Bluetooth Low Energy (BLE)
- Safe connection with 128-bit encryption
- App programming with iOS or Android Smartphone: Finder YOU
- Can be managed through standard pushbuttons, BEYON and Type 013.B9 wireless buttons

- Suitable for electric shutters, blind or curtain control
- Transmission protocol Bluetooth Low Energy (BLE)
- Safe connection with 128-bit encryption
- App programming with iOS or Android Smartphone: Finder YOU
- Can be managed through standard pushbuttons, BEYON and Type 013.B9 wireless buttons

**Bluetooth single channel multifunction relay**

**NEW** 13.21.8.230.B000

**NEW** 13.21.8.230.S000

**Type 13.21.8.230.B000**

- BLE communication protocol
- Round wall box (ie: Ø 60 mm) mounting
- 12 available functions
- Up to 8 scenarios
- Pushbutton Phase or Neutral connection

**Radio frequency remote actuator for BLISS2**

**Type 13.21.8.230.S000**

- 868 MHz long-range radio frequency transmission
- Multi-zone heating/cooling function
- Hygrostat function combined with the BLISS2 thermostat
- Compatible with the BLISS2 smart thermostat

13.21

Screw terminals



YESLY



BLISS2



- 1 CO (SPDT) 16 A 250 V AC
- Bluetooth Low Energy (BLE) transmission protocol
- 128-bit encrypted connection
- Programmable via app Finder YOU compatible with iOS and Android operating systems
- It can be connected to wired buttons or to BEYON and 013B9 wireless buttons
- Recess mounting

- 1 CO (SPDT) 16 A 250 V AC
- Compatible with BLISS2 smart thermostat
- Heating/cooling systems - direct or solenoid control
- It can be used in dehumidification or forced ventilation systems

For outline drawing see page 16

**Contact specification**

Contact configuration		1 CO (SPDT)	1 CO (SPDT)
Rated current	A	16	16
Rated voltage/ Maximum switching voltage	V AC	250	250
Rated load AC1	VA	3600	3600
Rated load AC15 (230 V AC)	VA	600	600
Single phase motor rating (230 V AC)	W	500	500
Nominal lamp rating 230V:			
incandescent/halogen	W	1000	—
fluorescent tubes with electronic ballast	W	500	—
fluorescent tubes with electromagnetic ballast	W	350	—
CFL	W	300	—
LED 230 V	W	200	—
LV halogen or LED with electronic ballast	W	200	—
LV halogen or LED with electromagnetic ballast	W	500	—

**Supply specification**

Nominal voltage (U <sub>N</sub> )	V AC (50/60 Hz)	110...230	110...230
	V DC	—	—
Rated power AC/DC	VA (50 Hz)/W	2.8 / 0.8	2.8 / 0.8
Operating range	AC (50 Hz)	(0.8...1.1)U <sub>N</sub>	(0.8...1.1)U <sub>N</sub>
	DC	—	—

**Technical data**

Electrical life at rated load in AC1	cycles	50 · 10 <sup>3</sup>	50 · 10 <sup>3</sup>
Maximum impulse duration		continuous	—
Dielectric strength between: open contacts	V AC	1000	1000
Ambient temperature range	°C	-10...+50	-10...+50
Protection category		IP 20	IP 20

**Approvals** (according to type)





## Ordering information

Example: Multifunction relay with YESLY Bluetooth, 2 contacts 6 A NO (SPST-NO), 110...230 V AC supply.

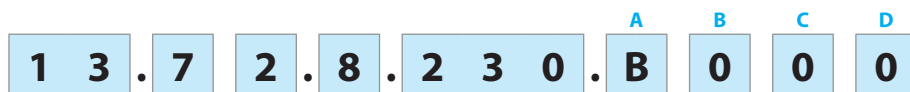

- Series**  
**Type**
- 0 = Step/Monostable, 35 mm rail (EN 60715) mount, 35 mm wide
  - 1 = Call & Reset relay, 35 mm rail (EN 60715) mount, 17.5 mm wide
  - 2 = Wall box mounting
  - 3 = Monostable relay, switch box mounting
  - 6 = Multifunction relay, 35 mm rail (EN 60715) mount, 17.5 mm wide
  - 7 = YESLY - Multifunction relay compatible with the most popular Italian wall switch systems: AVE, BTicino, Gewiss, Simon-Urmet, Vimar
  - 8 = Modular step relay, 35 mm rail (EN 60715) mount, 17.5 mm wide
  - 9 = Step relay and timing step relay, switch box mounting
  - S = YESLY - Shutter/blind/curtain actuator, wall box mounting

- No. of poles**
- 1 = 1 pole
  - 2 = 2 poles 6 A NO (SPST-NO) (type 13.72 and 13.22/S2)
  - 2 = 1 pole CO (SPDT) + 1 NO (SPST-NO)

- Supply version**
- 0 = AC (50/60 Hz)/DC
  - 8 = AC (50/60 Hz)
  - 9 = DC

- Supply voltage**
- 012 = 12 V AC/DC (13.01 and 13.12 only)
  - 012 = 12 V AC (13.31 only)
  - 024 = 24 V AC/DC (13.01 and 13.12 only)
  - 024 = 24 V DC (13.31 only)
  - 024 = 12...24 V AC/DC (13.61 only)
  - 125 = (110...125)V AC (13.01 only)
  - 230 = (230...240)V AC (13.01 and 13.11)
  - 230 = 110...240 V AC (13.61 only)
  - 230 = 230 V AC (13.31, 13.81 and 13.91)
  - 230 = 110...230 V AC (13.21, 13.22, 13.72, 13.52)

- A: Transmission protocol**  
(only for Type 13.21/22/S2/72)
- B = Bluetooth Low Energy (BLE)
  - S = 868 MHz, compatible with BLISS2

- A: Contacts material**
- 0 = Standard
  - 4 = Standard AgSnO<sub>2</sub> (only for 13.31)

- B: Contact circuit**
- 0 = Standard
  - 3 = Standard NO (only for 13.31)

- Codes / Supply voltage**
- 13.01.0.012.0000 12 V AC/DC
  - 13.01.0.024.0000 24 V AC/DC
  - 13.01.8.125.0000 110...125 V AC
  - 13.01.8.230.0000 230...240 V AC
  - 13.11.8.230.0000 230...240 V AC
  - 13.12.0.012.0000 12 V AC/DC
  - 13.12.0.024.0000 24 V AC/DC
  - 13.21.8.230.B000 110...230 V AC YESLY
  - 13.21.8.230.S000 110...230 V AC BLISS2
  - 13.22.8.230.B000 110...230 V AC YESLY
  - 13.52.8.230.B000 110...230 V AC YESLY
  - 13.31.8.012.4300 12 V AC
  - 13.31.9.024.4300 24 V DC
  - 13.31.8.230.4300 230 V AC
  - 13.61.8.230.0000 110...240 V AC
  - 13.61.0.024.0000 12...24 V AC/DC
  - 13.72.8.230.B000 110...230 V AC YESLY BLE white
  - 13.72.8.230.B002 110...230 V AC YESLY BLE anthracite gray
  - 13.81.8.230.0000 230 V AC
  - 13.91.8.230.0000 230 V AC

- 0 = Type 13.72 white
- 2 = Type 13.72 anthracite gray

## Technical data

Insulation	13.01.8	13.01.0	13.11 - 13.12	13.31 - 13.61	13.81 - 13.91				
Dielectric strength									
between control circuit and supply V AC	4000	—	—	—	—	—	—	—	—
between control circuit and contacts V AC	4000	4000	—	—	—	—	—	—	—
between R-S-A2 and contacts V AC	—	—	2000	—	—	—	—	—	—
between supply and contacts V AC	4000	4000	—	2000	—	—	—	—	—
between open contacts V AC	1000	1000	1000	1000	1000	1000	1000	1000	1000
<b>Other data</b>	<b>13.01</b>		<b>13.11 - 13.12</b>	<b>13.31</b>	<b>13.61</b>	<b>13.81</b>	<b>13.91</b>	<b>13.21</b>	<b>13.22</b> <b>13.52</b> <b>13.72</b>
Power lost to the environment									
without contact current W	2.2	—	—	0.4	1	1.2	0.7	0.4	0.5
with rated current W	3.5	1.5	1.6	1.8	2	1.8	2.2	1.5	1.5
Max cable length for pushbutton connection m	100	100	—	200	200	100	100	100	100
Max. no. of illuminated pushbutton (≤1mA)	—	—	—	10*	15	12	—	5	5
<b>Terminals</b>	<b>13.01</b>		<b>13.11 - 13.12 - 13.31 - 13.61 - 13.72 - 13.81 - 13.91</b>			<b>13.21 - 13.22 - 13.52</b>			
Max. wire size	solid cable	stranded cable	solid cable	stranded cable	solid cable	stranded cable	solid cable	stranded cable	solid cable
mm <sup>2</sup>	1 x 6 / 2 x 4	1 x 6 / 2 x 2.5	1 x 6 / 2 x 4	1 x 4 / 2 x 2.5	1 x 2.5 / 2 x 1.5	1 x 2.5 / 2 x 1.5	1 x 2.5 / 2 x 1.5	1 x 2.5 / 2 x 1.5	1 x 2.5 / 2 x 1.5
AWG	1 x 10 / 2 x 12	1 x 10 / 2 x 14	1 x 10 / 2 x 12	1 x 12 / 2 x 14	1 x 14 / 2 x 16	1 x 14 / 2 x 16	1 x 14 / 2 x 16	1 x 14 / 2 x 16	1 x 14 / 2 x 16
Screw torque Nm	0.8		0.8			0.5			

\* For 8.230 version.



### Functions for types 13.01, 13.11, 13.12, 13.81, 13.91

Type	Functions	
13.01		<p><b>Monostable.</b> On closure of a switch between terminals (B2-B3) the output contact will close, and remain so, until the switch opens.</p>
		<p><b>Step relay (bistable).</b> After every impulse (B1-B2), the output contact changes state - alternately switching from open to closed and vice versa.</p>
13.11 13.12		<p><b>Call and Reset relay.</b> On momentary closure of the Set switch (S), the output contact closes. Only a momentary closure of the Reset switch (R) will open the output contact.</p>
13.81		<p><b>(RI) Step relay.</b> After every impulse, the output contact changes state - alternately switching from open to closed and vice versa.</p>
13.91		<p><b>(RI) Step relay.</b> After every impulse, the output contact changes state - alternately switching from open to closed and vice versa.</p>
		<p><b>(IT) Timing step relay.</b> On initial impulse the output contact closes and timing starts for the pre-set duration (fixed 10 min); On expiry of the time delay, the output contact opens. During the timing period it is possible to immediately open the contact with a further impulse.</p>

### Operating mode setup for type 13.91

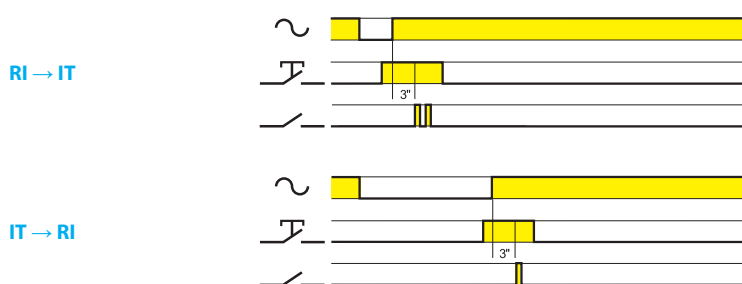

- Remove the supply voltage
- Press the control button
- Apply the supply to the relay, keeping the button closed.  
After 3 second, the light will flash twice to indicate the selection of the "IT" function, or flash once for "RI" function.

Functions for type 13.61

Type	Functions
13.61.8.230	<p><b>(RM) Monostable.</b> On closure of a switch between terminal 3 and Line (or Neutral, in case of 3-wire connection) the output contact will close, and remain so, until the switch opens.</p>
	<p><b>(IT) Timing step relay.</b> On initial impulse the output contact closes and timing starts for the pre-set duration T; On expiry of the time delay, the output contact opens. During the timing period it is possible to immediately open the contact with a further impulse. Switch-off delay time: 30s...20min.</p>
	<p><b>(RI) Step relay.</b> After every impulse, the output contact changes state - alternately switching from open to closed and vice versa.</p>
	<p><b>Light ON.</b> With this function set - the output contact stays permanently closed.</p>
13.61.0.024	<p><b>(RM) Monostable.</b> On closure of a switch between terminal 3 and Line (or Neutral, in case of 3-wire connection) the output contact will close, and remain so, until the switch opens.</p>
	<p><b>(IT) Timing step relay.</b> On initial impulse the output contact closes and timing starts for the pre-set duration T; On expiry of the time delay, the output contact opens. During the timing period it is possible to immediately open the contact with a further impulse. Switch-off delay time: 30s...20min.</p>
	<p><b>(RI) Step relay.</b> After every impulse, the output contact changes state - alternately switching from open to closed and vice versa.</p>
	<p><b>Light ON.</b> With this function set - the output contact stays permanently closed.</p>

## Functions for type 13.22, 13.72 and 13.21.8.230.B000

### Relay settings

Multifunction electronic relays can be configured with the Finder YOU app, available for iOS or Android systems. This product is ready-to-use preset with the factory setting (RI) Step relay on both channels.

Type	Functions	
13.21-B000 13.22 13.72		<p><b>(RM) Monostable relay.</b> On closure of the switch the output will close, and remain so, until the switch opens.</p>
		<p><b>(RI) Step relay (pushbutton control).</b> After every impulse, the output contact changes state - alternately switching from open to closed and vice versa.</p>
		<p><b>(RIa) Step relay - lighting switch control (Type 13.22 and 13.21.8.230.B000 only).</b> Each time a lighting switch is activated, the output contact changes state. The output state can also be changed using YESLY wireless pushbutton, a smartphone, or voice assistants. Ideal for converting a traditional lighting system using one, two, or four way switches, into a Smart system. (See page 17).</p>
		<p><b>(LE) Asymmetric flasher (starting pulse on) with control signal.</b> Power is permanently applied to the relay. Closing Signal Switch (S) causes the output contacts to transfer immediately and cycle between ON (T1) and OFF (T2), until opened.</p>
		<p><b>(DE) Interval with control signal on.</b> Power is permanently applied to the relay. On momentary or maintained closure of Signal Switch (S), the output contacts transfer, and remain so for the duration of the preset delay, after which they reset.</p>
		<p><b>(BE) Staircase timer.</b> On initial impulse the output contact closes and timing starts for the pre-set duration; subsequent impulses during the timing period will extend the timing period by the full pre-set value. On expiry of the time delay, the output contact opens.</p>
		<p><b>(ME) Staircase timer + Staircase maintenance.</b> In addition to the Staircase timer function (BE), an impulse of <math>\geq 5</math> seconds will close the output contact for 60 minutes, after which time the contact will open. Ideal for maintenance or cleaning activities. The 60 minute timing can be interrupted by a further impulse of <math>\geq 5</math> seconds, when the output contact then opens.</p>
		<p><b>(BP) Staircase timer with switch off early warning.</b> On initial impulse the output contact closes and the timing starts for the pre-set duration. After the timing period, the output contact blinks off once; 10 seconds later the contact blinks off twice, and after a further 10 seconds the contact opens. During the pre-set and 20 second warning time, it is possible, by a further impulse, to extend the time by the full pre-set value.</p>
		<p><b>(MP) Staircase timer with switch off early warning + staircase maintenance.</b> In addition to the Staircase timer function (BP), an impulse of <math>\geq 5</math> seconds will close the output contact for 60 minutes, after which time the output contact blinks off once; 10 seconds later the contact blinks off twice, and after a further 10 seconds the contact will open. Ideal for maintenance or cleaning activities. The 60 minute timing can be interrupted by a further impulse of <math>\geq 5</math> seconds, when the output contact then opens.</p>

Functions for type 13.22, 13.72, 13.21.8.230.B000 and 13.S2

Type	Functions	
13.21-B000 13.22 13.72		<p><b>(IT) Timing step relay.</b> On initial impulse the output contact closes and timing starts. On expiry of the time delay, the output contact opens. During the timing period it is possible to immediately open the contact with a further impulse.</p>
		<p><b>(IP) Timing step relay with switch off early warning.</b> On initial impulse the output contact closes and timing starts. After the timing period, the output contact blinks off once; 10 seconds later the contact blinks off twice, and after a further 10 seconds the contact opens. During the pre-set and 20 second warning time, it is possible to immediately open the output contact by a further impulse.</p>
		<p><b>(FZ) Timing monostable.</b> The output will be closed when the switch is closed, except where the switch is closed for greater than the preset time T1 - in which case the output contact opens.</p>
13.22 13.72		<p><b>(VB) Bathroom light + fan.</b> Channels Ch1 and Ch2 both close when the P1 command is pressed. At the expiry of T1 Ch1 opens and after a further delay of T2, Ch2 opens. Ch1 can be prematurely opened by another press of P1.</p>
		<p><b>(CP) Ringbell + light.</b> A press to P1 closes Ch1 for the pre-set time T1. While Ch1 is closed Ch2 executes a blinking function, at a rate set by T2. Subsequent presses to P1 extends the Ch1 closed time by re-triggering T1.</p>
13.S2 13.72		<p><b>(TP) Roller shutter.</b> A short press (&lt;1 second) to P1 ("up" pushbutton) initiates a 500ms delay before Ch1 closes for time T1. Pressing P1 again within time period T1 will immediately open Ch1 contact. If P1 is closed for more than 1 second the Ch1 contact will open immediately P1 opens. The same operation applies to P2 and Ch2 contact, used to control the "down" function.</p>

Sequences

P1 (SET): press to advance through the sequence

P2 (RESET): press to return to Step 1

Type	Functions	Sequences			
		1	2	3	4
13.22 13.72	02				
	03				
	04				
	05				
	06				
	07				
	08				

Wiring diagrams (13.01, 13.11, 13.12 and 13.31)

**Type 13.01**

Step wiring diagram

Red LED indication:  
Continuous = relay ON

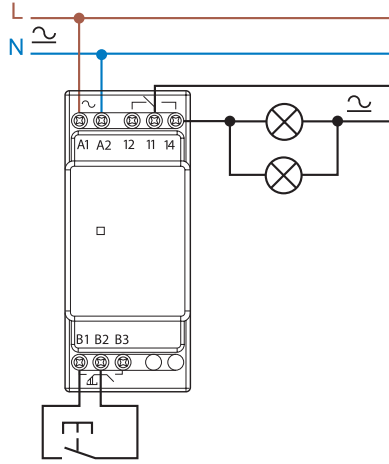

**Type 13.01**

Monostable wiring diagram

Red LED indication:  
Continuous = relay ON

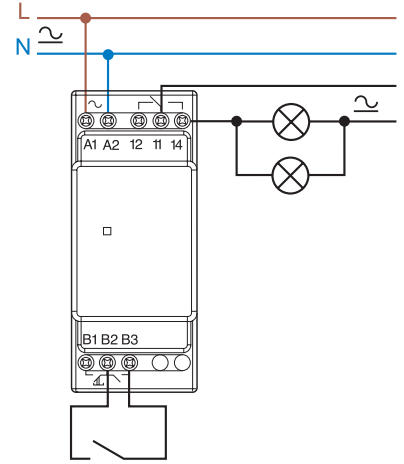

**Type 13.11**

Call & reset relay

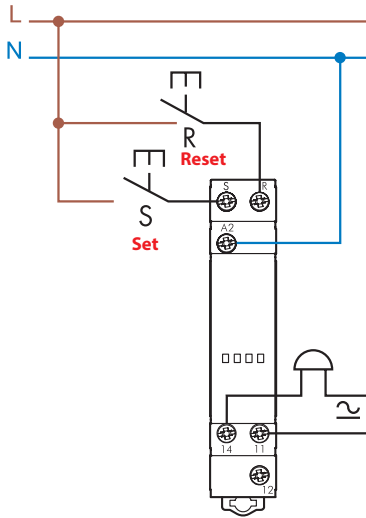

**Type 13.12**

Call & reset relay

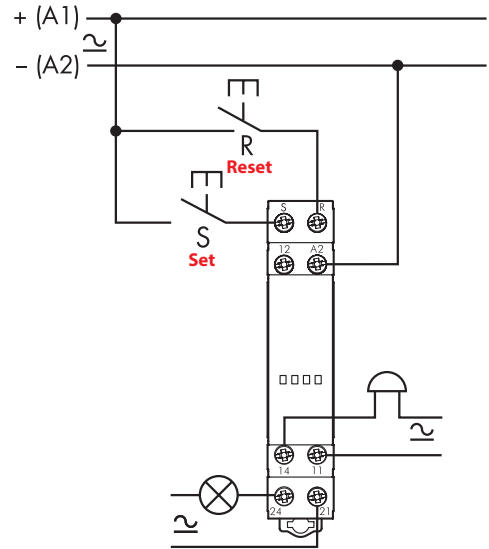

**Type 13.31**

Connection

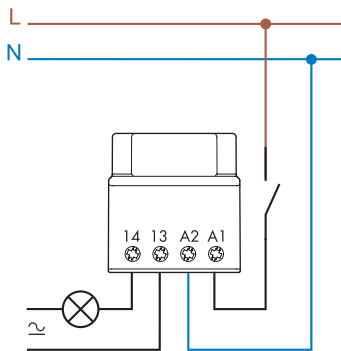

K

Wiring diagrams (13.61)

**Type 13.61.8.230**

3 wire connection  
Red LED indication:  
Continuous = relay ON  
Blinking = relay OFF

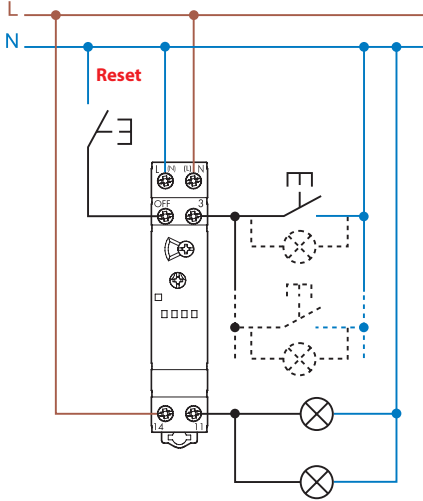

Maximum 10 ( $\leq 1$  mA)  
illuminated push buttons

**Type 13.61.8.230**

4 wire connection  
Red LED indication:  
Continuous = relay ON  
Blinking = relay OFF

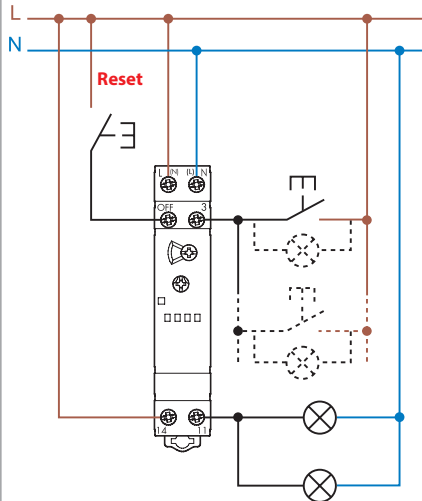

Maximum 10 ( $\leq 1$  mA)  
illuminated push buttons

**Type 13.61.0.024**

4 wire connection  
Red LED indication:  
Continuous = relay ON  
Blinking = relay OFF

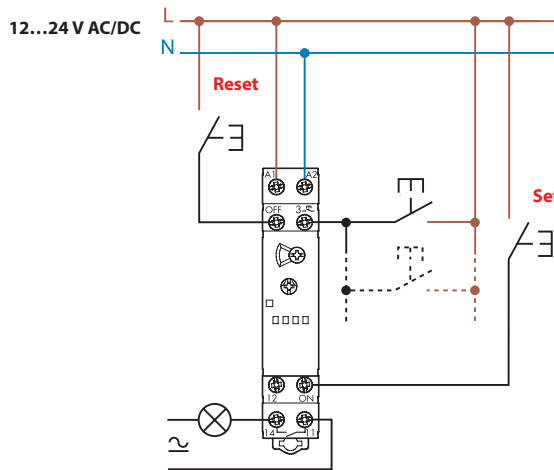

**Type 13.61.8.230 - Examples of multiple 4 wire connection with centralized reset pushbutton**

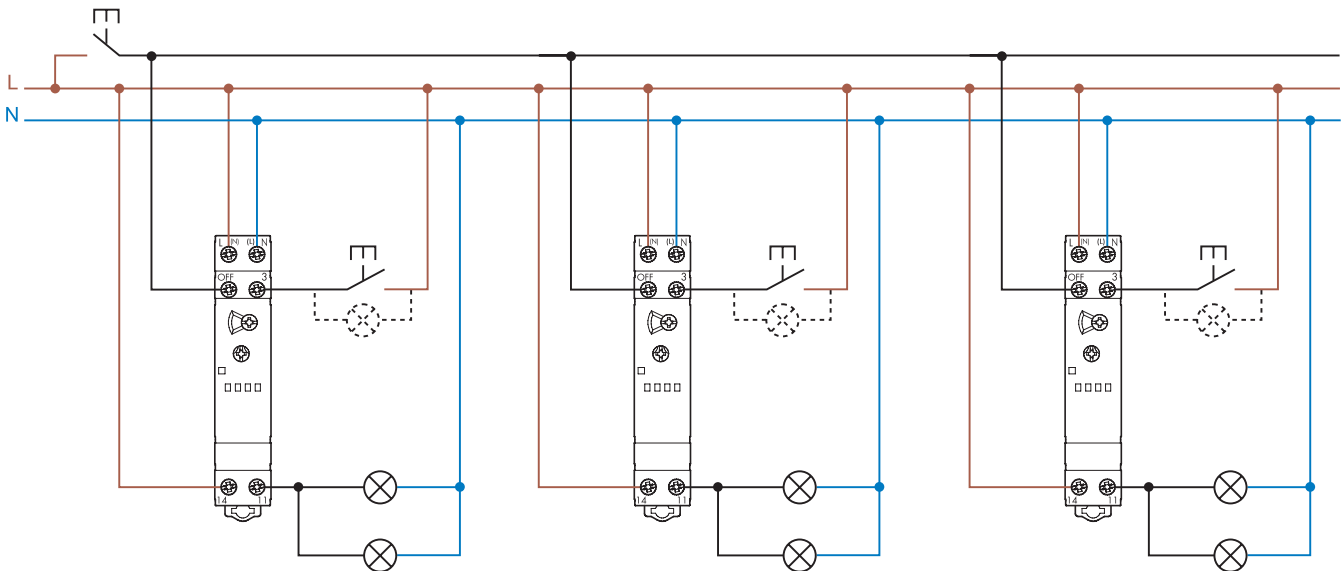

Wiring diagrams (13.81, 13.91 and 13.21.8.230.B000)

**Type 13.81**

3 wire connection  
Red LED indication: a  
Continuous = relay ON  
Blinking = relay OFF

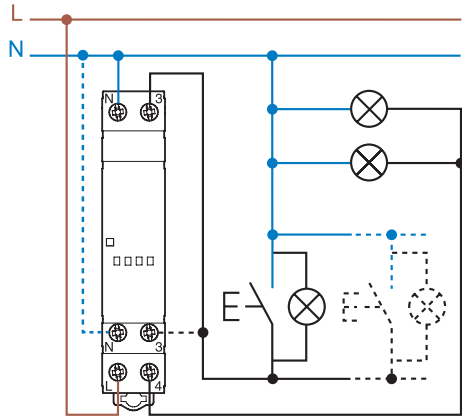

Maximum 15 ( $\leq 1$  mA)  
illuminated push buttons

**Type 13.81**

4 wire connection  
Red LED indication:  
Continuous = relay ON  
Blinking = relay OFF

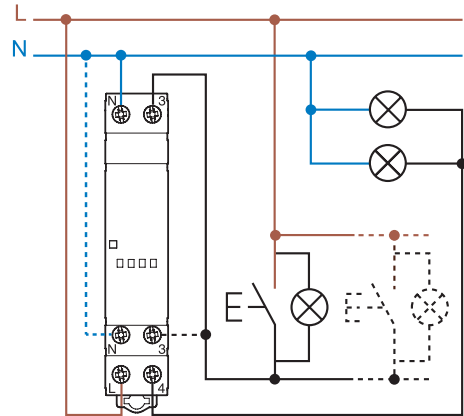

Maximum 15 ( $\leq 1$  mA)  
illuminated push buttons

**Type 13.91**

3 wire connection

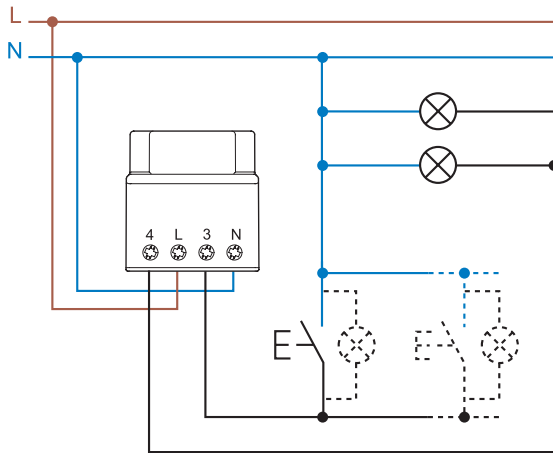

Maximum 12 ( $\leq 1$  mA)  
illuminated push buttons

**Type 13.91**

4 wire connection

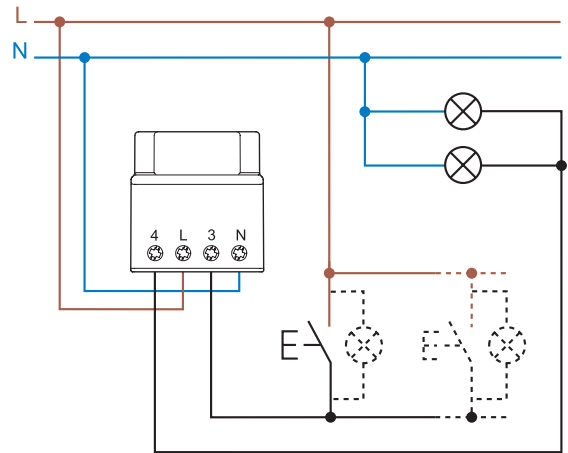

Maximum 12 ( $\leq 1$  mA)  
illuminated push buttons

**Type 13.21.8.230.B000**

Wiring with pushbutton to phase

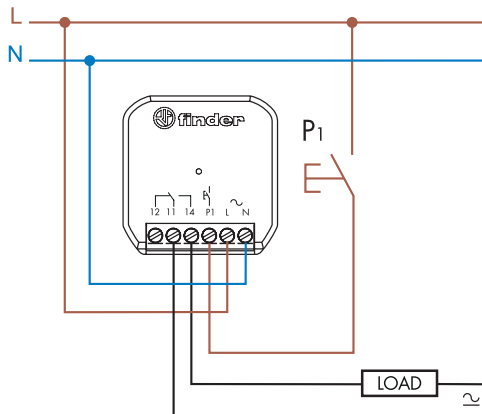

**Type 13.21.8.230.B000**

Wiring with pushbutton to neutral

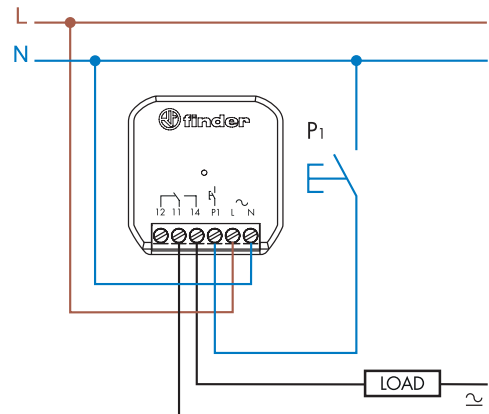

**Note:**

- If the load is powered by a phase other than the one that powers the 13.21, a 50% reduction in the lamp capacity must be considered (set the "Different phase" function from the Finder YOU app).

Wiring diagrams (13.21.8.230.S000, 13.22, 13.S2 and 13.72)

**Type 13.22**

4 wire connection

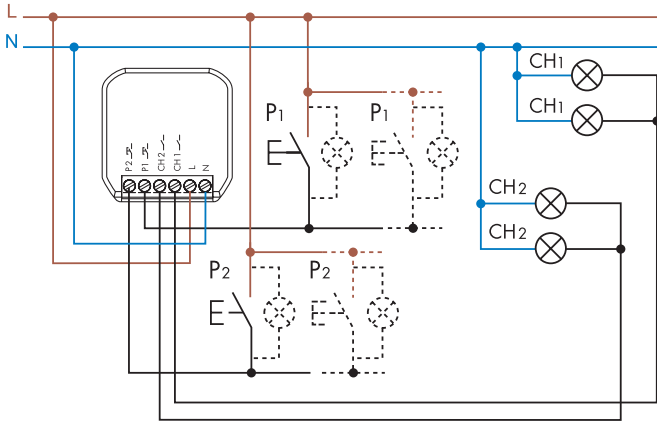

Maximum 5 ( $\leq 1$  mA)  
illuminated push buttons

**Type 13.S2**

4 wire connection

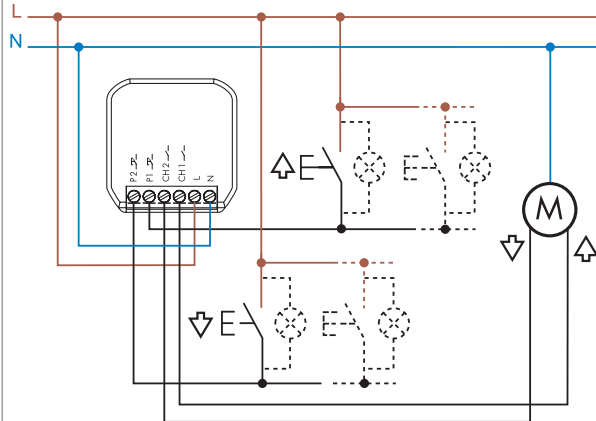

Maximum 5 ( $\leq 1$  mA)  
illuminated push buttons

**Type 13.72**

4 wire connection

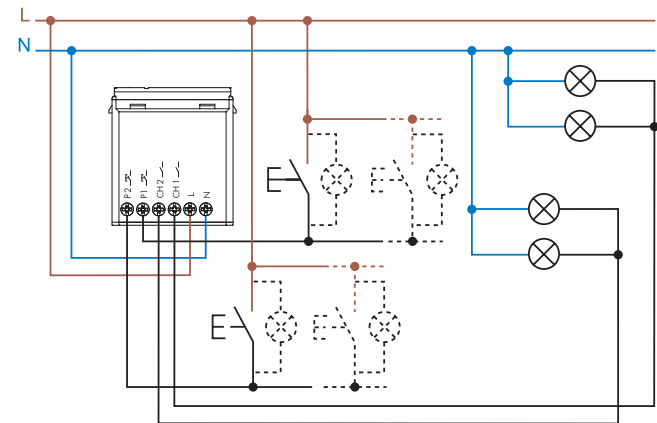

Maximum 5 ( $\leq 1$  mA)  
illuminated push buttons

**Type 13.21.8.230.S000**

Solenoid valve with 2, 3 and 4 wires or direct connection

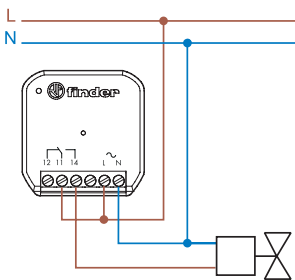

2 wires

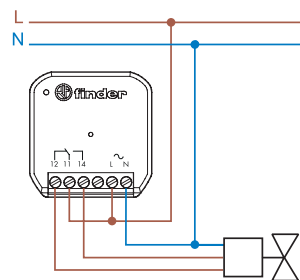

3 wires

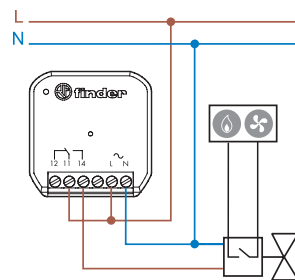

4 wires

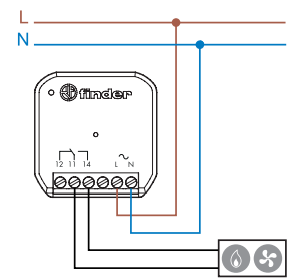

Heating/cooling

Example of connection with a 230 V AC solenoid valve, always refer to the technical characteristics of the solenoid valve.



Examples of applications

Function TP - Roller Blinds, Shutters and Curtains

Type 13.72

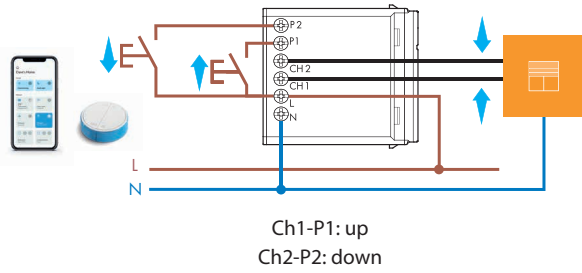

Type 13.S2

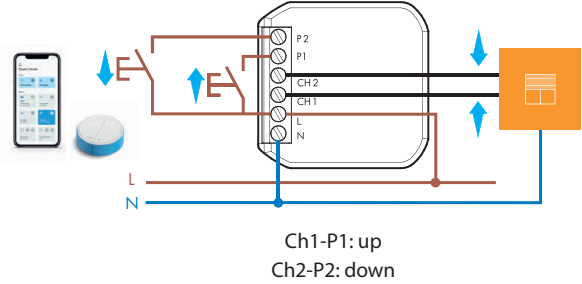

Function VB - Bathroom light + fan

Type 13.72

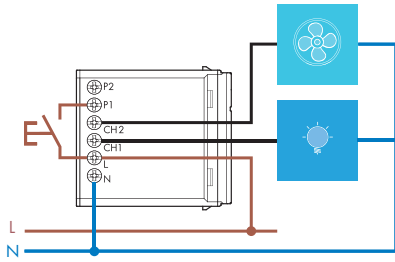

Type 13.22

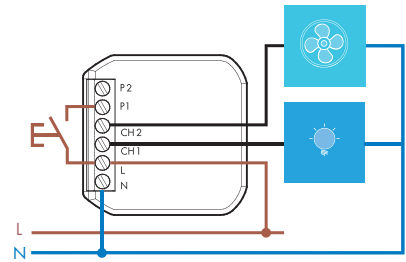

Function CP - Ringbell + Lights

Type 13.72

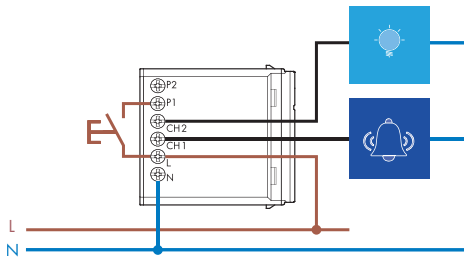

Type 13.22

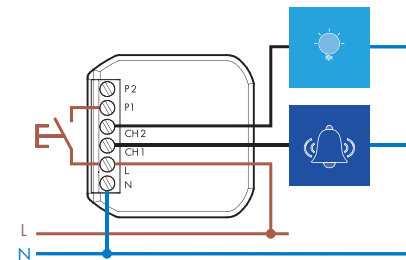

Type 13.22 - Special function R1a - Step relay (switch control).

Ideal for converting a traditional lighting system using one, two, or four way switches, into a Smart system.

The Smart system controls with just a momentary push to a wired, YESLY wireless or Smartphone pushbutton

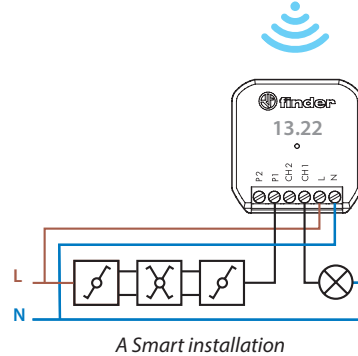
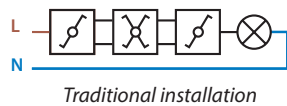

Examples of applications

**Type 13.21.8.230 - Special function R1a - Step relay (switch control).**

**Ideal for converting a traditional lighting system using one, two, or four way switches, into a Smart system.  
Any existing system can be made Smart with minimum change or disruption**

*The smart system can be controlled by: wireless buttons, smartphone and gateway*

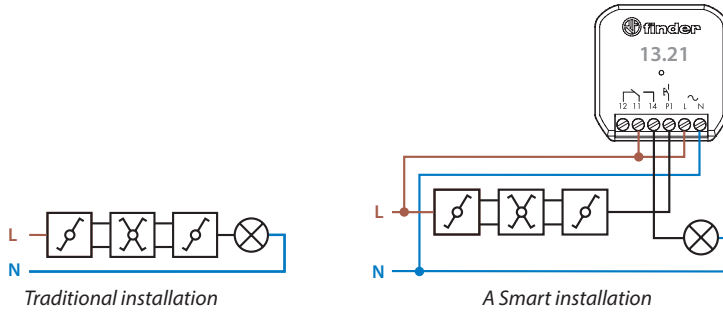

## Outline drawings

Type 13.01  
Screw terminal

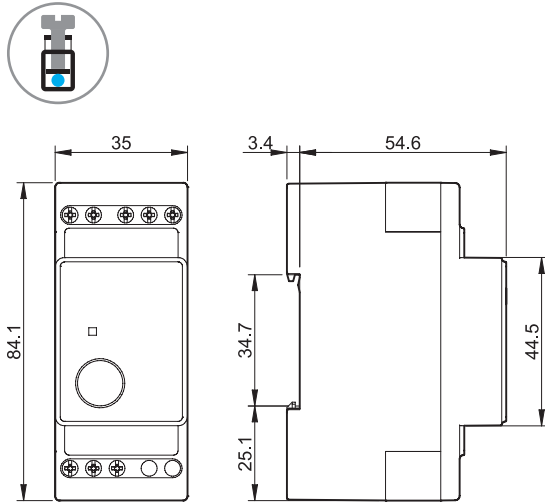

Type 13.11  
Screw terminal

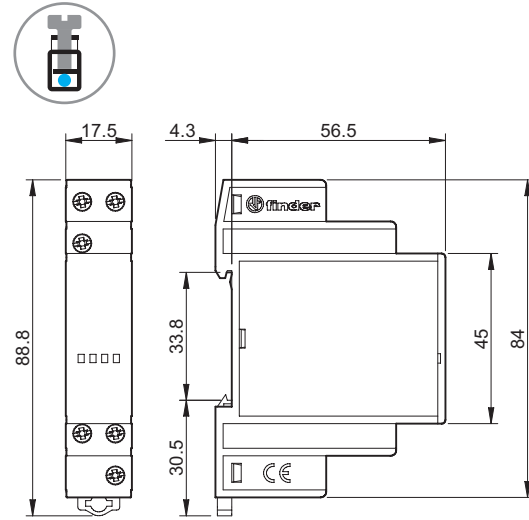

Type 13.12  
Screw terminal

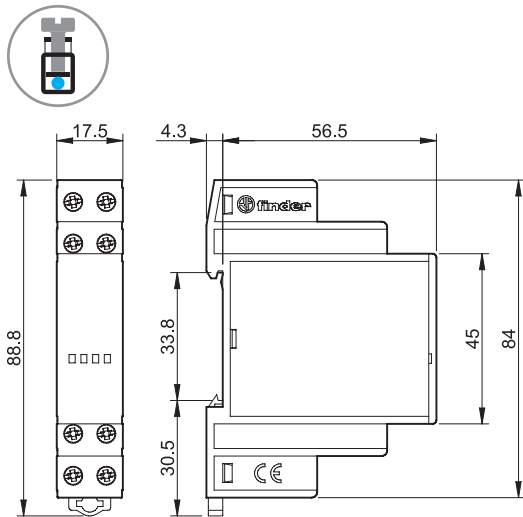

Types 13.31/13.91  
Screw terminal

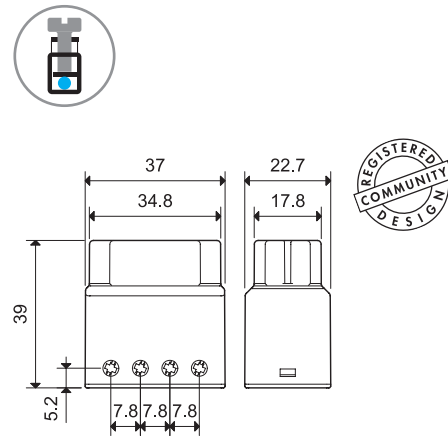

Type 13.61.0.024.0000  
Screw terminal

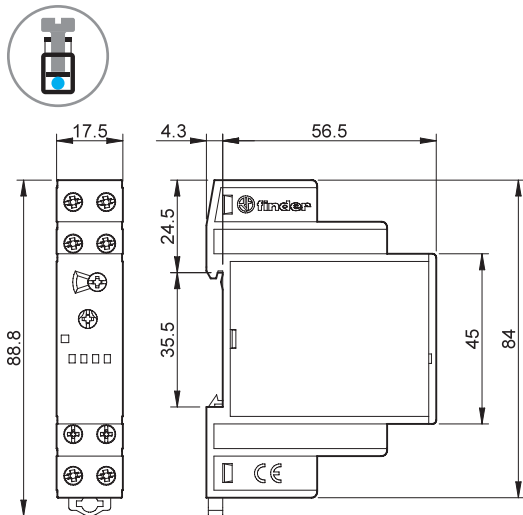

Type 13.61.8.230.0000  
Screw terminal

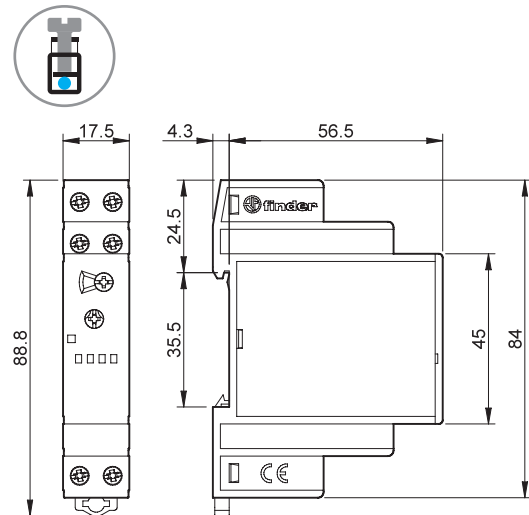

## Outline drawings

Type 13.81  
Screw terminal

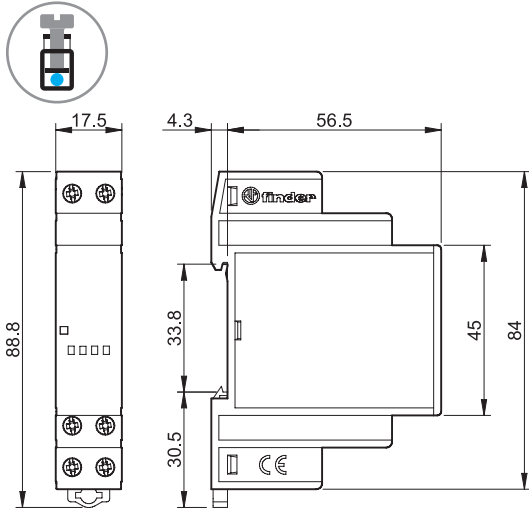

Type 13.72  
Screw terminal

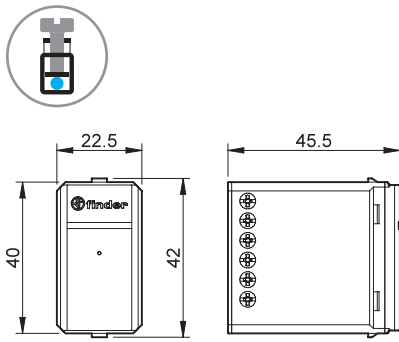

Type 13.21 / 13.22 / 13.S2  
Screw terminal

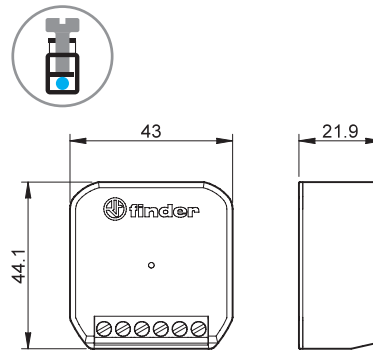

Type 13.21.8.230.S000  
Screw terminal

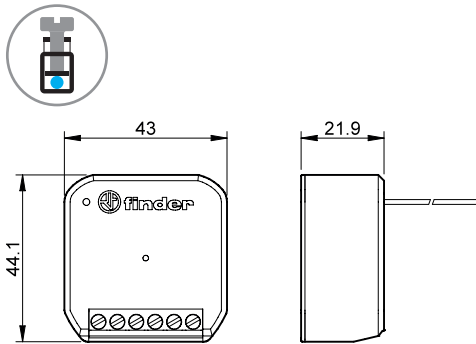

K

## Accessories



011.01

**Adaptor for panel mounting**, for type 13.01, 35 mm wide

011.01



020.01

**Adaptor for panel mounting**, for type 13.11, 13.12, 13.61 and 13.81, 17.5 mm wide

020.01

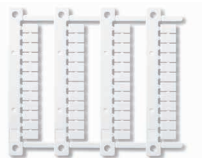

060.48

**Sheet of marker tags (CEMBRE Thermal transfer printers)** for relays types 13.11, 13.12, 13.61 and 13.81 (48 tags), 6 x 12 mm

060.48



013.00

**Pushbutton phase/neutral converter.** Use this with a pre-existing neutral wired pushbutton when retro fitting a device designed only for phase connected pushbuttons. This avoids any radical change to the existing wiring.

013.00

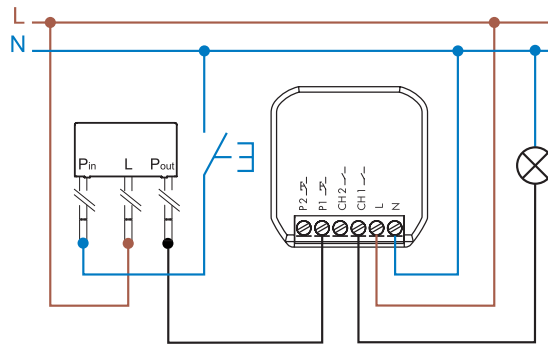

Application example with type 13.22



013.17

**Adapter for DIN rail**, to install devices 13.22, 13.21, 13.52 in the electrical panel.

013.17

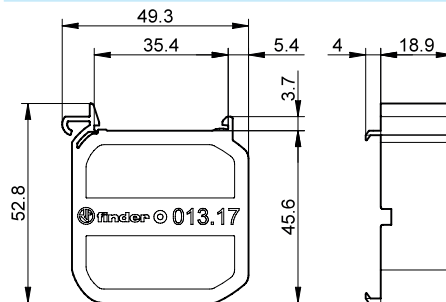



# Modular step relays 16 A



Automation for  
blinds, grilles  
and shutters



Living room  
light control



Bedroom  
light control



Lighting control  
in corridors (for  
hotels, offices  
and hospitals)



20  
SERIES





**1 or 2 Pole 16 A Step relays for direct 35 mm rail (EN 60715) mounting**

- 17.4 mm wide
- Test button with mechanical indicators
- Choice of 7 switching sequences
- AC coils and DC coils
- Identification label
- According to EN 60601-1 2 x MOPP
- Possible to connect illuminated push buttons with the additional part 026.00
- 35 mm rail (EN 60715) mount
- Cadmium free contact material

20.21/22/24/26/27/28/23  
Screw terminal



FOR UL RATINGS SEE:  
"General technical information" page V

For outline drawing see page 5

**Contact specification**

Contact configuration	1 NO (SPST-NO)	2 NO (DPST-NO)	1NO+1NC (SPST-NO+SPST-NC)
Rated current/Maximum peak current	A 16/30	16/30	16/30
Rated voltage/ Maximum switching voltage	V AC 250/400	250/400	250/400
Rated load AC1	VA 4000	4000	4000
Rated load AC15 (230 V AC)	VA 750	750	750
Nominal lamp rating:			
230 V incandescent/halogen W	2000	2000	2000
fluorescent tubes with electronic ballast W	1000	1000	1000
fluorescent tubes with electromagnetic ballast W	750	750	750
CFL W	400	400	400
230 V LED W	400	400	400
LV halogen or LED with electronic ballast W	400	400	400
LV halogen or LED with electromagnetic ballast W	800	800	800
Minimum switching load	mW (V/mA) 1000 (10/10)	1000 (10/10)	1000 (10/10)
Standard contact material	AgSnO <sub>2</sub>	AgSnO <sub>2</sub>	AgSnO <sub>2</sub>

**Coil specification**

Nominal voltage (U <sub>N</sub> )	V AC (50/60 Hz)	8 - 12 - 24 - 48 - 110 - 120 - 230 - 240	
	V DC	12 - 24 - 48 - 110	12 - 24 - 48 - 110
Rated power AC/DC	VA (50 Hz)/W	6.5/5	6.5/5
Operating range	AC	(0.85...1.1)U <sub>N</sub> (50 Hz)/(0.9...1.1)U <sub>N</sub> (60 Hz)	
	DC	(0.9...1.1)U <sub>N</sub>	(0.9...1.1)U <sub>N</sub>

**Technical data**

Mechanical life AC/DC	cycles	300 · 10 <sup>3</sup>	300 · 10 <sup>3</sup>	300 · 10 <sup>3</sup>
Electrical life at rated load in AC1	cycles	100 · 10 <sup>3</sup>	100 · 10 <sup>3</sup>	100 · 10 <sup>3</sup>
Minimum/Maximum impulse duration		0.1 s/1 h (according to EN 60669)	0.1 s/1 h (according to EN 60669)	0.1 s/1 h (according to EN 60669)
Insulation between coil and contacts (1.2/50 μs)	kV	4	4	4
Ambient temperature range	°C	-40...+40	-40...+40	-40...+40
Protection category		IP 20	IP 20	IP 20

**Approvals** (according to type)



### Ordering information

Example: 20 series relay, 35 mm rail (EN 60715) mount, double phase switch, 2 NO 16 A contacts, coil rated at 12 V DC, AgSnO<sub>2</sub> contacts.

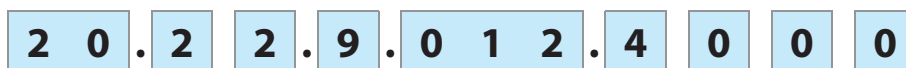

- Series** —————
- Type** —————  
2 = 35 mm rail (EN 60715) mount
- No. of poles** —————  
1 = Single phase switch 1 NO (SPST-NO)  
2 = Double phase switch 2 NO (DPST-NO)  
3 = Double phase switch 1 NC+ 1 NO (SPST-NO+SPST-NC)  
4 = 4 sequence double phase switch 2 NO (DPST-NO)  
6 = 3 sequence double phase switch 2 NO (DPST-NO)  
7 = 3 sequence double phase switch 2 NO (DPST-NO)  
8 = 4 sequence double phase switch 2 NO (DPST-NO)
- Contact material**  
0 = AgNi  
4 = AgSnO<sub>2</sub>
- Coil voltage**  
See coil specifications
- Coil version**  
8 = AC (50/60 Hz)  
9 = DC

### Technical data

Insulation					
Dielectric strength					
between supply and contacts	V AC	4000			
between open contacts	V AC	2000			
between adjacent contacts	V AC	2000			
Other data					
Power lost to the environment					
with rated current and coil deenergised	W	1.3 (20.21, 20.23, 20.28)		2.6 (20.22, 20.24, 20.26, 20.27)	
Screw torque	Nm	0.8		0.8	
Max. wire size		Coil terminals		Contact terminals	
		solid cable	stranded cable	solid cable	stranded cable
	mm <sup>2</sup>	1 x 4 / 2 x 2.5	1 x 2.5 / 2 x 2.5	1 x 6 / 2 x 4	1 x 4 / 2 x 2.5
	AWG	1 x 12 / 2 x 14	1 x 14 / 2 x 14	1 x 10 / 2 x 12	1 x 12 / 2 x 14

If the coil is operated for a prolonged period of time, adequate ventilation of the relays must be provided - suggested gap of 9 mm between adjacent relays.

### Coil specifications

#### DC version data

Nominal voltage U <sub>N</sub>	Coil code	Operating range		Resistance R	Consumption I at U <sub>N</sub>
		U <sub>min</sub>	U <sub>max</sub>		
V		V	V	Ω	mA
12	9.012	10.8	13.2	27	440
24	9.024	21.6	26.4	105	230
48	9.048	43.2	52.8	440	110
110	9.110	99	121	2330	47

#### AC version data

Nominal voltage U <sub>N</sub>	Coil code	Operating range		Resistance R	Consumption I at U <sub>N</sub> (50 Hz)
		U <sub>min</sub>	U <sub>max</sub>		
V		V	V	Ω	mA
8	8.008	6.8	8.8	4	800
12	8.012	10.2	13.2	7.5	550
24	8.024	20.4	26.4	27	275
48	8.048	40.8	52.8	106	150
110	8.110	93.5	121	590	64
120	8.120	102	132	680	54
230	8.230	192	253	2500	28
240	8.240	204	264	2700	27.5

Type	Number of steps	Sequence			
		1	2	3	4
20.21	2				
20.22	2				
20.23	2				
20.24	4				
20.26	3				
20.27	3				
20.28	4				

K

### Wiring diagrams

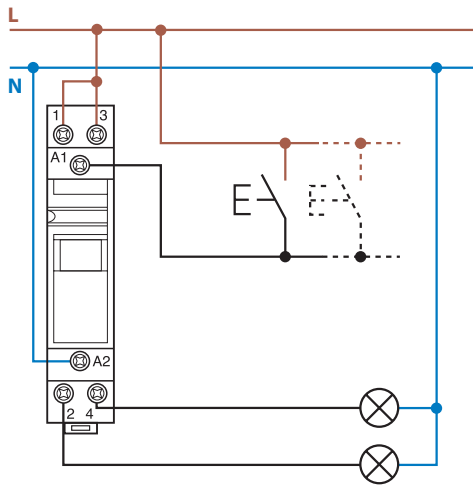

Example: 230 V AC supply voltage.

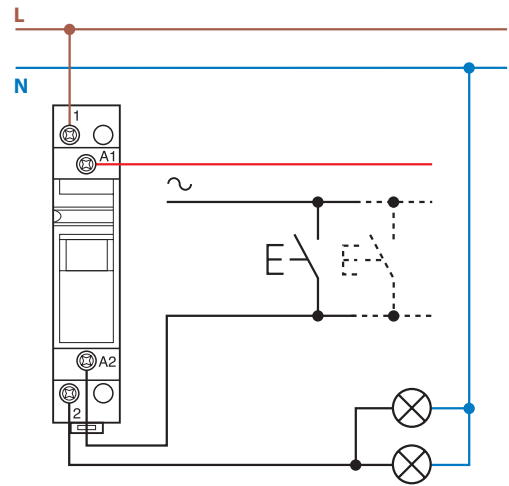

Example: 24 V AC supply voltage.

### Outline drawings

Type 20.21  
Screw terminal

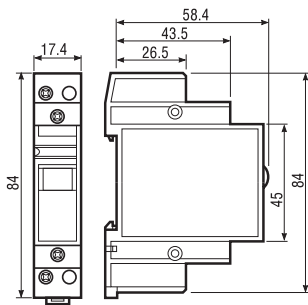

Types 20.22/24/26/27/28  
Screw terminal

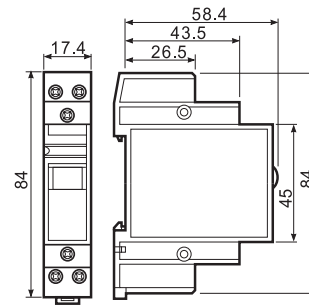

Type 20.23  
Screw terminal

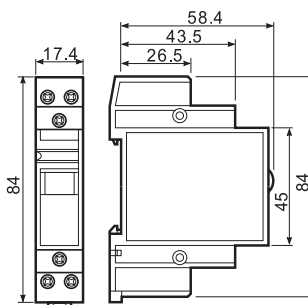

Accessories

Module for use with illuminated push-buttons

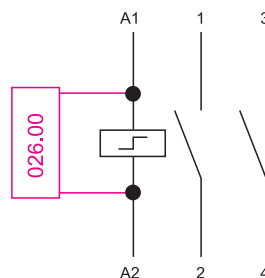
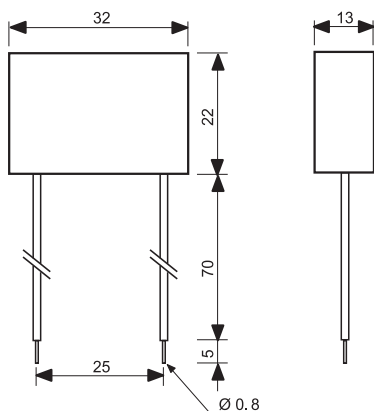

Type 026.00

Sealed construction, 7.5 cm insulated flexible wire termination.

Example of wiring diagram of type 026.00

This module is necessary when using between 1 and a maximum of 15 illuminated push buttons in the coil circuit (Each 1.5 mA max, 230 V AC). It must be connected in parallel to the coil of the relay.



020.01

Adaptor for panel mounting, 17.5 mm wide

020.01



022.09

Separator for rail mounting, plastic, 9 mm wide

022.09

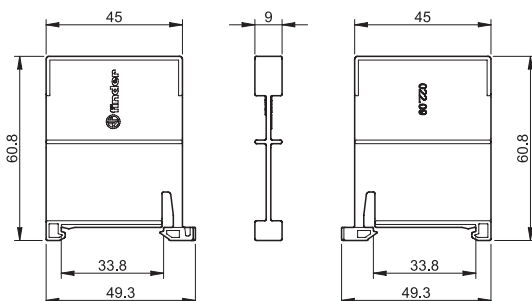

# Step relays 10 A



Lighting control  
in corridors (for  
hotels, offices  
and hospitals)



Bedroom  
light control



Living room  
light control



26  
SERIES



**1 or 2 Pole electromechanical step relay with electrically separate coil and contact circuits**

- Choice of 6 switching sequences
- Screw terminal connections
- AC coil
- Panel mount
- Cadmium free contact material

26.01/02/04/06/08/03

Screw terminal



For outline drawing see page 6

**Contact specification**

	26.01	26.02, 04, 06, 08	26.03
Number of contacts	1 NO (SPST-NO)	2 NO (DPST-NO)	1NO+1NC (SPST-NO+SPST-NC)
Rated current/Maximum peak current	A 10/20	10/20	10/20
Rated voltage/ Maximum switching voltage	V AC 250/400	250/400	250/400
Rated load AC1	VA 2500	2500	2500
Rated load AC15 (230 V AC)	VA 500	500	500
Nominal lamp rating:			
230 V incandescent/halogen W	800	800	800
fluorescent tubes with electronic ballast W	400	400	400
fluorescent tubes with electromagnetic ballast W	360	360	360
CFL W	200	200	200
230 V LED W	200	200	200
LV halogen or LED with electronic ballast W	200	200	200
LV halogen or LED with electromagnetic ballast W	400	400	400
Minimum switching load	mW (V/mA) 1000 (10/10)	1000 (10/10)	1000 (10/10)
Standard contact material	AgNi	AgNi	AgNi

**Coil specification**

	26.01	26.02, 04, 06, 08	26.03
Nominal voltage (UN)	V AC (50 Hz) 12 - 24 - 48 - 110 - 230	12 - 24 - 48 - 110 - 230	12 - 24 - 48 - 110 - 230
	V DC —	—	—
Rated power AC/DC	VA (50 Hz)/W 4.5/—	4.5/—	4.5/—
Operating range	AC (50 Hz) (0.8...1.1)U <sub>N</sub>	(0.8...1.1)U <sub>N</sub>	(0.8...1.1)U <sub>N</sub>
	DC —	—	—

**Technical data**

	26.01	26.02, 04, 06, 08	26.03
Mechanical life AC/DC	cycles 300 · 10 <sup>3</sup>	300 · 10 <sup>3</sup>	300 · 10 <sup>3</sup>
Electrical life at rated load in AC1	cycles 100 · 10 <sup>3</sup>	100 · 10 <sup>3</sup>	100 · 10 <sup>3</sup>
Minimum/Maximum impulse duration	0.1 s/1 h (according to EN 60669)	0.1 s/1 h (according to EN 60669)	0.1 s/1 h (according to EN 60669)
Insulation between coil and contacts (1.2/50 μs)	kV 4	4	4
Ambient temperature range	°C -40...+40	-40...+40	-40...+40
Protection category	IP 20	IP 20	IP 20

**Approvals** (according to type)



### Ordering information

Example: 26 series screw terminal, panel mount relay, double phase switch 2 NO (DPST-NO) 10 A contacts, coil rated 12 V AC.

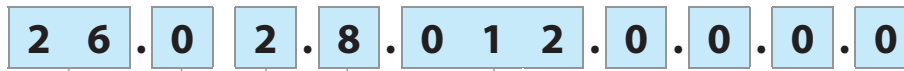

- Series** —————
- Type** —————  
0 = Screw terminal
- No. of poles** —————  
1 = Single phase switch 1 NO (SPST-NO)  
2 = Double phase switch 2 NO (DPST-NO)  
3 = Double phase switch 1 NO + 1 NC (SPST-NO + SPST-NC)  
4 = 4 sequences double phase switch 2 NO (DPST-NO)  
6 = 3 sequences double phase switch 2 NO (DPST-NO)  
8 = 4 sequences double phase switch 2 NO (DPST-NO)
- Coil voltage** —————  
See coil specifications
- Coil version** —————  
8 = AC (50 Hz)

### Technical data

Insulation				
Dielectric strength				
between supply and contacts	V AC	4000		
between open contacts	V AC	2000		
between adjacent contacts	V AC	2000		
Other data		26.01, 26.03, 26.08	26.02, 26.04, 26.06	
Power lost to the environment				
with rated current and coil de-energised W		0.9		1.8
Screw torque	Nm	0.8		0.8
Max. wire size		solid cable	stranded cable	solid cable
	mm <sup>2</sup>	1 x 4 / 2 x 2.5	1 x 2.5 / 2 x 2.5	1 x 4 / 2 x 2.5
	AWG	1 x 12 / 2 x 14	1 x 14 / 2 x 14	1 x 12 / 2 x 14

### Coil specifications

#### AC version data

Nominal voltage U <sub>N</sub>	Coil code	Operating range		Resistance	Consumption
		U <sub>min</sub>	U <sub>max</sub>	R	I at U <sub>N</sub> (50 Hz)
V		V	V	Ω	mA
12	8.012	9.6	13.2	17	370
24	8.024	19.2	26.4	70	180
48	8.048	38.4	52.8	290	90
110	8.110	88	121	1500	40
230	8.230	184	253	6250	20

Type	Number of steps	Sequence			
		1	2	3	4
26.01	2				
26.02	2				
26.03	2				
26.04	4				
26.06	3				
26.08	4				

K



### Wiring diagrams

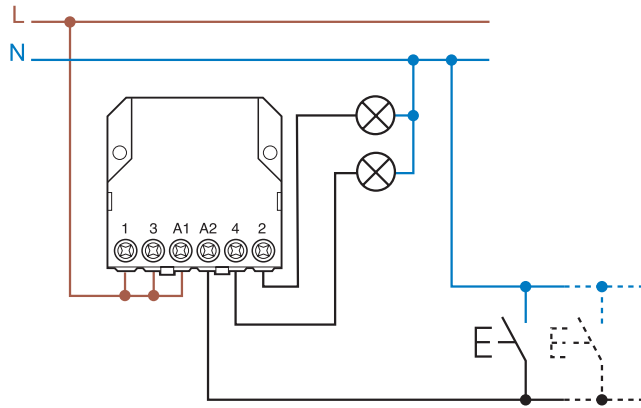

3 wire connection

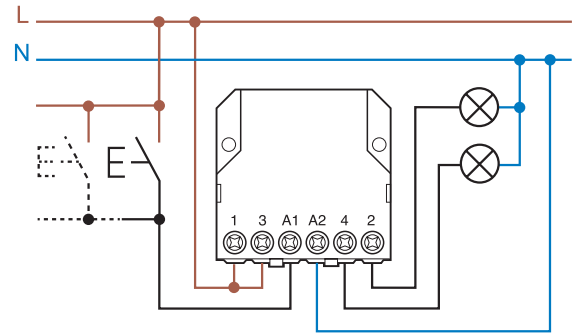

4 wire connection

### Accessories

#### for 12 and 24 V DC control applications

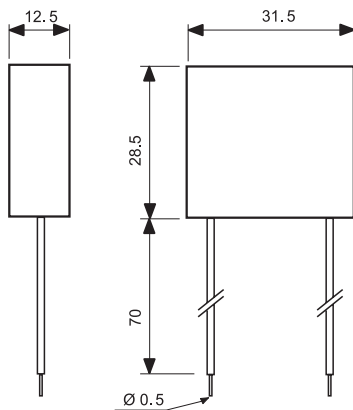

**Type: 026.9.012**  
Nominal voltage: 12 V DC  
Max temperature: +40 °C  
Operating range: (0.9...1.1)U<sub>N</sub>

**Type: 026.9.024**  
Nominal voltage: 24 V DC  
Max temperature: +40 °C  
Operating range: (0.9...1.1)U<sub>N</sub>

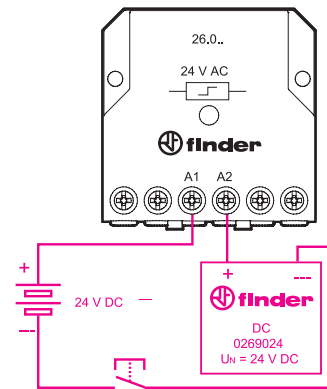

Example of wiring for 24 V DC control application.

#### Module for use with illuminated push buttons (230 V AC applications)

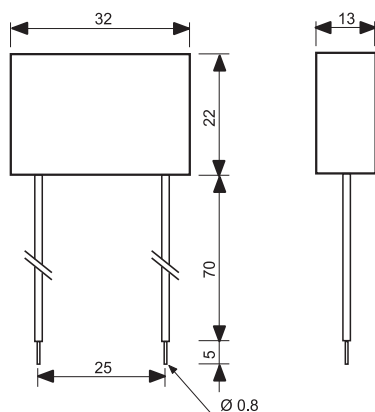

**Type 026.00**  
Sealed construction, 7.5 cm insulated flexible wire termination.

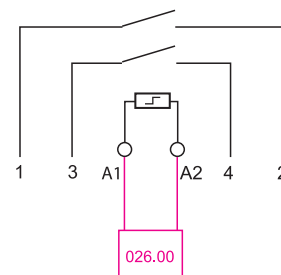

**Example of wiring diagram of type 026.00**  
This module is necessary when using between 1 and a maximum of 15 illuminated push buttons in the coil circuit (Each 1 mA max, 230 V AC). It must be connected in parallel to the coil of the relay (see diagram).

Outline drawings

Type 26.01  
Screw terminal

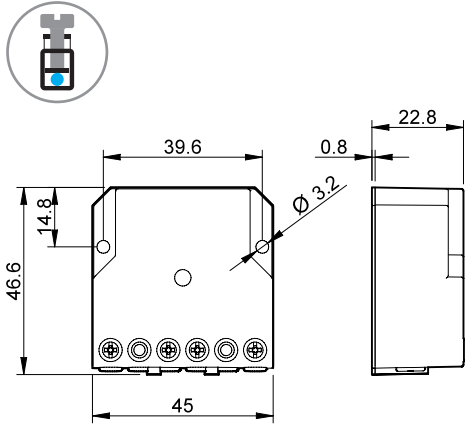

Types 26.02 / 04 / 06 / 08  
Screw terminal

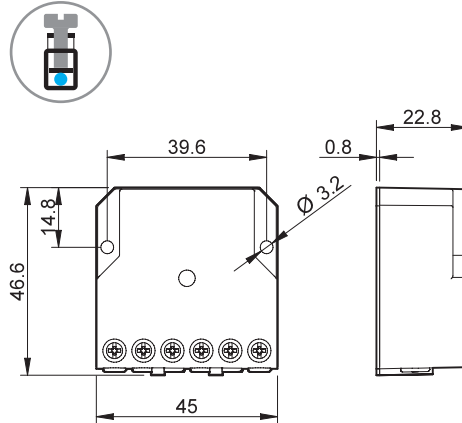

Type 26.03  
Screw terminal

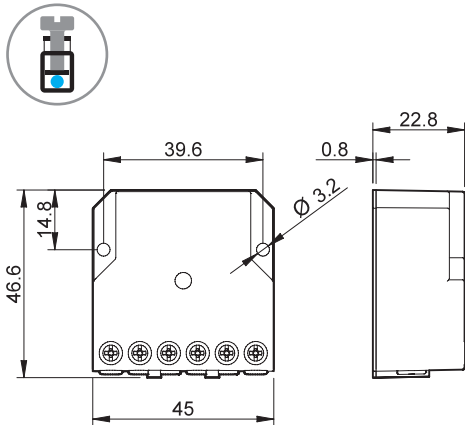

# Step relays 10 A



Lighting control  
in corridors (for  
hotels, offices  
and hospitals)



Bedroom  
light control



Living room  
light control



27  
SERIES



1 or 2 Pole electromechanical step relay, for electrically common coil and contact circuits

27.0x - Connect up to 24 illuminated push buttons with the addition of module 027.00

27.2x - Connect up to 15 illuminated push buttons (without additional module) - incorporates coil power limiter to permit continuous coil energisation

- Choice of 3 switching sequences
- Screw terminal connections
- AC coil
- Panel mount
- Cadmium free contact material
- Italian Patent

27.0x / 2x  
Screw terminal



For outline drawing see page 5

**Contact specification**

Number of contacts	1 or 2		1 or 2
Rated current/Maximum peak current	A		10/20
Rated voltage/ Maximum switching voltage	V AC	110/—	230/—
Rated load AC1	VA	1100	2300
Rated load AC15	VA	250	500
Nominal lamp rating:			
230 V incandescent/halogen W	—	1000	1000
fluorescent tubes with electronic ballast W	200	400	400
fluorescent tubes with electromagnetic ballast W	180	360	360
CFL W	100	200	200
230 V LED W	—	200	200
LV halogen or LED with electronic ballast W	100	200	200
LV halogen or LED with electromagnetic ballast W	200	400	400
Minimum switching current	mW (V/mA)	10	
Standard contact material	AgNi		

**Coil specification**

Nominal voltage (U <sub>N</sub> )	V AC (50/60 Hz)	110	230	230
	V DC	—		
Pickup/continuous power	VA (50 Hz)	4/4		25/1
Operating range	AC 50 Hz/AC 60 Hz	(0.8...1.1)U <sub>N</sub> / (0.85...1.1)U <sub>N</sub>		
	DC	—		

**Technical data**

Mechanical life AC/DC	cycles	300 · 10 <sup>3</sup>		300 · 10 <sup>3</sup>
Electrical life at rated load in AC1	cycles	100 · 10 <sup>3</sup>		100 · 10 <sup>3</sup>
Max no. of illuminated push-button	(≤ 1 mA)	4 (24 with module 027.00)		15
Minimum/Maximum impulse duration		0.1 s/1 h (according to EN 60669)		0.1 s/continuous
Ambient temperature range	°C	-40...+40		-40...+40
Protection category		IP 20		IP 20

Approvals (according to type)



27.0x



- Single or 2 double phase switch 1 NO (SPST-NO) or 2 NO (DPST-NO)

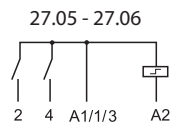
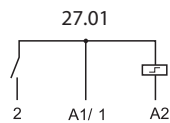

27.2x EVO



- Single or 2 double phase switch 1 NO (SPST-NO) or 2 NO (DPST-NO) with coil power limiter

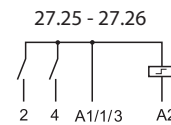
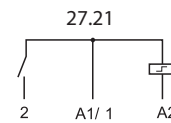

### Ordering information

Example: 27 series screw terminal, panel mount step relay, single phase switch 1 NO (SPST-NO) 10 A contact, coil rated 230 V AC.

**2 7 . 0 1 . 8 . 2 3 0 . 0 . 0 . 0 . 0**

- Series** —————
- Type** —————  
0 = Clamp terminal  
2 = Clamp terminal, with coil power limiter
- No. of poles** —————  
1 = Single phase switch 1 NO (SPST-NO)  
5 = 4 sequences double phase switch 2 NO (DPST-NO)  
6 = 3 sequences double phase switch 2 NO (DPST-NO)
- Coil voltage** —————  
See coil specifications
- Coil version** —————  
8 = AC (50/60 Hz)

### Technical data

Other data		27.01, 27.21		27.05, 27.06, 27.25, 27.26	
Power lost to the environment with rated current and coil de-energised	W	0.9		1.8	
Screw torque	Nm	0.8		0.8	
Max. wire size		solid cable	stranded cable	solid cable	stranded cable
	mm <sup>2</sup>	2 x 2.5	1 x 4 / 2 x 2.5	2 x 2.5	1 x 4 / 2 x 2.5
	AWG	2 x 14	1 x 12 / 2 x 14	2 x 14	1 x 12 / 2 x 14

### Coil specifications

#### Types 27.01, 27.05, 27.06

Nominal voltage $U_N$ V	Coil code	Operating range (50 Hz)		Resistance R Ω	Consumption I at $U_N$ (50 Hz) mA
		$U_{min}$ V	$U_{max}$ V		
110	8.110	88	121	1400	42.0
230	8.230	184	253	6500	17.5

#### Types 27.21, 27.25, 27.26

Nominal voltage $U_N$ V	Coil code	Operating range (50 Hz)		Resistance R Ω	Consumption	
		$U_{min}$ V	$U_{max}$ V		pick up I at $U_N$ (50 Hz) mA	continuous I at $U_N$ (50 Hz) mA
230	8.230	184	253	1250	100	4

Type	Number of steps	Sequence			
		1	2	3	4
27.01/21	2				
27.05/25	4				
27.06/26	3				

### Wiring diagram

#### Type 27.01/05/06

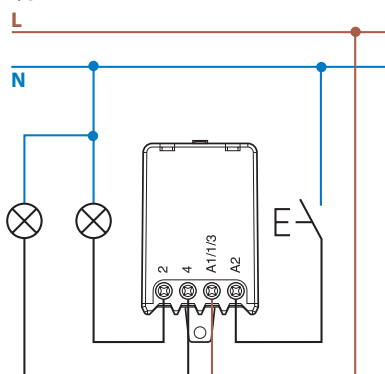

#### Type 27.21/25/26

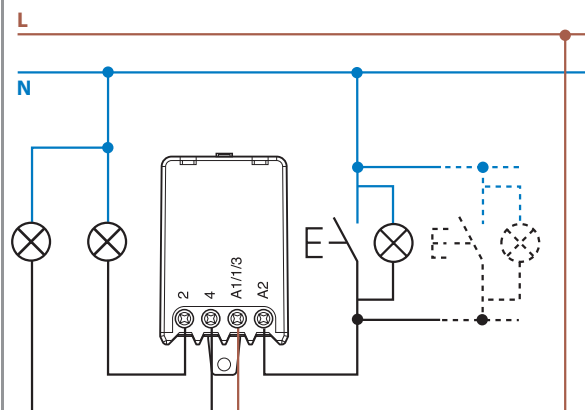

Accessories for types 27.01, 27.05, 27.06

Module for illuminated push-button (230 V AC applications)

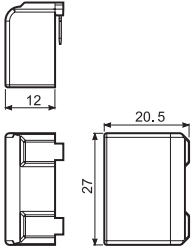

**Type 027.00**

This module is necessary if using up to a maximum of 24 illuminated push-buttons (1 mA max, 230 V AC) in the switching input circuit. It must be plugged directly into the relay.

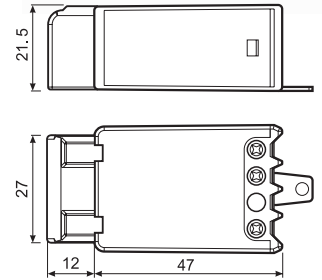
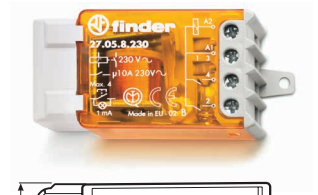

**Type 27.0x + 027.00**

Outline drawing

Types 27.0x / 2x  
Screw terminal

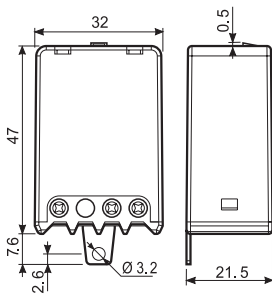





# Modular contactors 25 - 32 - 40 - 63 A



Hotel room  
energy-  
enabling units



Garden and night  
lighting



Streetlights  
and car park  
lighting



Bathrooms  
lighting  
control



Office lighting  
control



Pump control

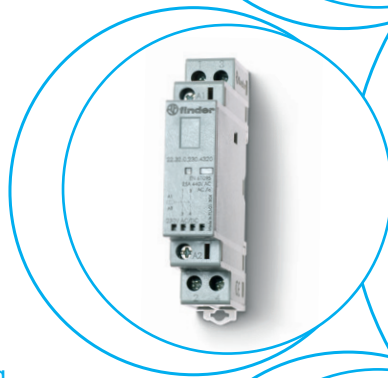

**22**  
SERIES



**25 A modular contactor - 2 pole**

- 17.5 mm wide
- NO contact gap  $\geq 3$  mm, double break
- Continuous duty for the coil and contacts
- AC/DC silent coil (with varistor protection)
- Protective separation (reinforced insulation) between coil and contacts
- Mechanical and LED indicators as standard
- Auto-On-Off selector version available
- AgNi and AgSnO<sub>2</sub> contact versions available
- Compliant with EN 61095: 2009
- Auxiliary contact module available, quick-assembly with the main contactor (1 NO + 1 NC and 2 NO versions)
- For railway applications; materials compliant with fire and smoke characteristics (EN 45545-2 + A1: 2016)
- 35 mm rail (EN 60715) mount

Screw terminal



For outline drawings see page 14

**Contact specification**

Contact configuration	2 NO, 3 mm* (or 1 NO + 1 NC or 2 NC)		
Rated current/Maximum peak current	A	25/80	25/120
Rated voltage	V AC	250/440	250/440
Rated load AC1 / AC-7a (per pole @ 250 V)	VA	6250	6250
Rated current AC3 / AC-7b	A	10	10
Rated load AC15 (per pole @ 230 V)	VA	1800	1800
Single-phase motor rating (230 V AC)	kW	1	1
Rated current AC-5a (per pole @ 250 V)	A	15	15
Rated current AC-7c	A	—	10
Nominal lamp rating:			
230 V incandescent/halogen W		800	2000
fluorescent tubes with electronic ballast W		300	800
fluorescent tubes with electromagnetic ballast W		200	500
CFL W		100	200
230 V LED W		100	200
LV halogen or LED with electronic ballast W		100	200
LV halogen or LED with electromagnetic ballast W		300	800
Breaking capacity DC1: 24/110/220 V	A	25/5/1	25/5/1
Minimum switching load	mW (V/mA)	1000 (10/10)	1000 (10/10)
Contact material		AgNi	AgSnO <sub>2</sub>
<b>Coil specification</b>			
Nominal voltage (U <sub>N</sub> )	V DC/AC (50/60 Hz)	12 - 24 - 48 - 60 - 120 - 230	12 - 24 - 48 - 60 - 120 - 230
Rated power AC/DC	VA (50 Hz)/W	2/2.2	2/2.2
Operating range	DC/AC (50/60 Hz)	(0.8...1.1)U <sub>N</sub>	(0.8...1.1)U <sub>N</sub>
Holding voltage	DC/AC (50/60 Hz)	0.4 U <sub>N</sub>	0.4 U <sub>N</sub>
Must drop-out voltage	DC/AC (50/60 Hz)	0.1 U <sub>N</sub>	0.1 U <sub>N</sub>
<b>Technical data</b>			
Mechanical life AC/DC	cycles	2 · 10 <sup>6</sup>	2 · 10 <sup>6</sup>
Electrical life at rated load AC-7a	cycles	70 · 10 <sup>3</sup>	30 · 10 <sup>3</sup>
Operate/release time	ms	30/20	30/20
Insulation between coil and contacts (1.2/50 μs)	kV	6	6
Ambient temperature range	°C	-25...+50	-25...+50
Protection category		IP 20	IP 20

Approvals (according to type)

**22.32.0.xxx.1xx0**



- AgNi contacts, specifically intended for resistive and slightly inductive loads as well as for motor loads

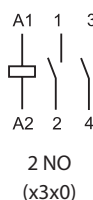

**22.32.0.xxx.4xx0**



- AgSnO<sub>2</sub> contacts, specifically intended for lamp loads and for high inrush current loads

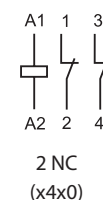
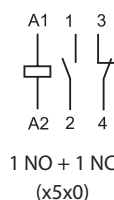

\* Contact gap  $\geq 3$  mm for NO contacts only; NC contacts  $\geq 1.5$  mm

**25 A modular contactor - 4 pole**

- 35 mm wide
- NO contact gap  $\geq 3$  mm, double break
- Continuous duty for the coil and contacts
- AC/DC silent coil (with varistor protection)
- Protective separation (reinforced insulation) between coil and contacts
- Mechanical and LED indicators as standard
- Auto-On-Off selector version available
- AgNi and AgSnO<sub>2</sub> contact versions available
- Compliant with EN 61095: 2009
- Auxiliary contact module available, quick-assembly with the main contactor (1 NO + 1 NC and 2 NO versions)
- For railway applications; materials compliant with fire and smoke characteristics (EN 45545-2 + A1: 2016)
- 35 mm rail (EN 60715) mount

Screw terminal



For outline drawings see page 14

**22.34.0.xxx.1xx0**



- AgNi contacts, specifically intended for resistive and slightly inductive loads as well as for motor loads

**22.34.0.xxx.4xx0**



- AgSnO<sub>2</sub> contacts, specifically intended for lamp loads and for high inrush current loads

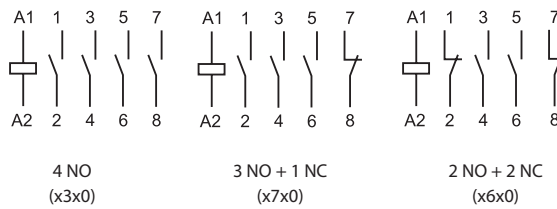

**Contact specification**

Contact configuration	4 NO, 3 mm* (or 3NO + 1NC or 2NO + 2NC)	
Rated current/Maximum peak current	A	25/80
Rated voltage	V AC	250/440
Rated load AC1/AC-7a (per pole @ 250 V)	VA	6250
Rated current AC3/AC-7b	A	10
Rated load AC15 (per pole @ 230 V)	VA	1800
Three-phase motor rating (400 - 440 V AC)	kW	4
Rated current AC-5a (per pole @ 250 V)	A	15
Rated current AC-7c	A	—
Nominal lamp rating:		
230 V incandescent/halogen W		800
fluorescent tubes with electronic ballast W		300
fluorescent tubes with electromagnetic ballast W		200
CFL W		100
230 V LED W		100
LV halogen or LED with electronic ballast W		100
LV halogen or LED with electromagnetic ballast W		300
Breaking capacity DC1: 24/110/220 V	A	25/5/1
Minimum switching load	mW (V/mA)	1000 (10/10)
Contact material		AgNi
<b>Coil specification</b>		
Nominal voltage (U <sub>N</sub> )	V DC/AC (50/60 Hz)	12 - 24 - 48 - 60 - 120 - 230
Rated power AC/DC	VA (50 Hz)/W	2/2.2
Operating range	DC/AC (50/60 Hz)	(0.8...1.1)U <sub>N</sub>
Holding voltage	DC/AC (50/60 Hz)	0.4 U <sub>N</sub>
Must drop-out voltage	DC/AC (50/60 Hz)	0.1 U <sub>N</sub>
<b>Technical data</b>		
Mechanical life AC/DC	cycles	2 · 10 <sup>6</sup>
Electrical life at rated load AC-7a	cycles	150 · 10 <sup>3</sup>
Operate/release time	ms	18/40
Insulation between coil and contacts (1.2/50 μs)	kV	6
Ambient temperature range	°C	-25...+50
Protection category		IP 20

\* Contact gap  $\geq 3$  mm for NO contacts only; NC contacts  $\geq 1.5$  mm

Approvals (according to type)



**40 - 63 A modular contactor - 4 pole**

- NO and NC contact gap  $\geq 3$  mm, double break
- Continuous duty for the coil and contacts
- AC/DC silent coil (with varistor protection)
- Protective separation (reinforced insulation) between coil and contacts
- Mechanical indicator as standard
- Compliant with EN 60947-4-1 (Mirror Contact) version available
- Auxiliary modules compliant with EN 60947-5-1 (mechanically linked contacts)
- AgSnO<sub>2</sub> contacts
- Compliant with EN 61095: 2009
- 35 mm rail (EN 60715) mount

Screw terminal



For outline drawings see page 14

**22.44.0.xxx.4xxx**



- For high inrush current loads 176 A
- Contact material AgSnO<sub>2</sub>

**22.64.0.xxx.4xxx**



- Specifically intended: for high inrush current loads 240 A
- Contact material AgSnO<sub>2</sub>

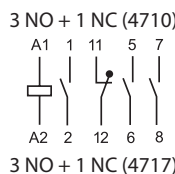
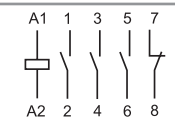
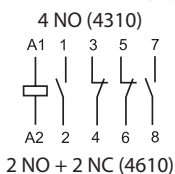
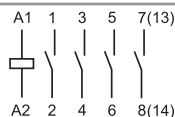

**Contact specification**

Contact configuration	4 NO, (or 3NO + 1NC or 2NO + 2NC) $\geq 3$ mm	
Rated current/Maximum peak current	A	40/176
Rated voltage/Maximum switching voltage	V AC	400/480
Rated load AC1 / AC-7a (per pole @ 400 V)	VA	16000
Rated current AC3 / AC-7b (400 V)	A	22
Three-phase motor rating (400 - 440 V AC)	kW	11
Rated current AC-5a (per pole @ 250 V)	A	20
Rated current AC-7c	A	—
Nominal lamp rating:		
230 V incandescent/halogen	W	4000
fluorescent tubes with electronic ballast	W	1500
fluorescent tubes with electromagnetic ballast	W	1500
CFL	W	1000
230 V LED	W	1000
LV halogen or LED with electronic ballast	W	1000
LV halogen or LED with electromagnetic ballast	W	1500
Breaking capacity DC1: 24/110/220 V	A	40/4/1.2
Minimum switching load	mW (V/mA)	1000 (17/50)
Contact material		AgSnO <sub>2</sub>

**Coil specification**

Nominal voltage (U <sub>N</sub> )	V DC/AC (50/60 Hz)	12 - 24 - 110...120 (110 V DC) - 230...240 (220 V DC)
Rated power AC/DC	VA (50 Hz)/W	6
Operating range	DC/AC (50/60 Hz)	(0.85...1.1)U <sub>N</sub>
Holding voltage	DC/AC (50/60 Hz)	0.85 U <sub>N</sub>
Must drop-out voltage	DC/AC (50/60 Hz)	0.2 U <sub>N</sub>

**Technical data**

Mechanical life AC/DC	cycles	3 · 10 <sup>6</sup>
Electrical life at rated load AC-7a	cycles	100 · 10 <sup>3</sup>
Operate/release time	ms	20/45
Insulation between coil and contacts (1.2/50 μs)	kV	6
Ambient temperature range	°C	See table Current - Temperature derating (page 9)
Protection category		IP 20

**Approvals** (according to type)



**32 A modular contactor - 2 or 4 pole**

- NO and NC contact gap  $\geq 3$  mm, double break
- Continuous duty for the coil and contacts
- AC/DC silent coil (with varistor protection)
- Protective separation (reinforced insulation) between coil and contacts
- Mechanical indicators as standard
- Compliant with EN 60947-4-1 (Mirror Contact) version available
- AgNi contacts
- Compliant with EN 61095: 2009
- 35 mm rail (EN 60715) mount

Screw terminal



For outline drawings see page 14

**NEW 22.72.0.xxx.1x10**



- 17.5 mm wide
- Contact material AgNi

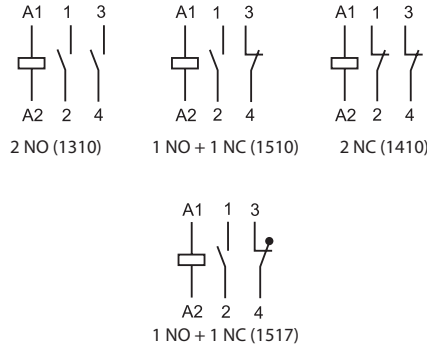

**NEW 22.74.0.xxx.1x10**



- 35 mm wide
- Contact material AgNi

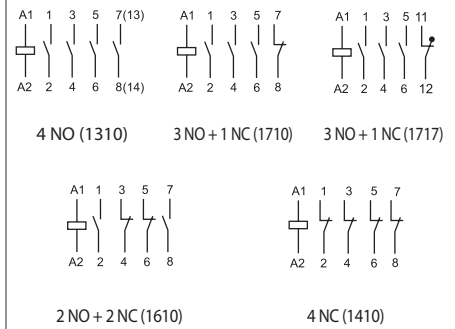

<b>Contact specification</b>		22.72.0	22.74.0
Contact configuration		2 NO, 1 NO + 1 NC, 2 NC	4 NO, 3 NO + 1 NC, 2 NO + 2 NC, 4 NC
Rated current/Maximum peak current	A	32/72	32/68
Rated voltage	V AC	230/400	230/400
Rated load AC1 / AC-7a (per pole @ 400 V)	VA	7000/—	7000/21 000
Rated current AC3 / AC-7b (per pole @ 400 V)	A	9 (NO) - 6 (NC)	8.5 (NO) - 8.5 (NC)
Single/Three-phase motor rating	kW	1.3 (NO) - 0.75 (NC) (@230 V AC)	4 (@400 V AC)
Rated current AC-5a (per pole @ 250 V)	A	13	13
Rated current AC-7c	A	—	—
Rated current AC15	A	12	12
Nominal lamp rating:			
230 V incandescent/halogen W		2500	2500
fluorescent tubes with electronic ballast W		700	700
CFL W		250	250
230 V LED W		300	300
LV halogen or LED with electronic ballast W		300	300
LV halogen or LED with electromagnetic ballast W		500	500
Breaking capacity DC1: 24/110/220 V	A	32/6/0.6	32/6/0.6
Minimum switching load	mW (V/mA)	1000 (17/50)	1000 (17/50)
Contact material		AgNi	AgNi
<b>Coil specification</b>			
Nominal voltage (U <sub>N</sub> )	V DC/AC (50/60 Hz)	24 - 48 - 110 - 220/24 - 48 - 110 - 230	
Rated Power AC/DC	VA (50 Hz)/W	2.1	2.6/3.8 (4 NC)
Operating range	AC/DC (50/60 Hz)	(0.85...1.1)U <sub>N</sub>	
Holding voltage	AC/DC (50/60 Hz)	0.85 U <sub>N</sub>	
Must drop-out voltage	AC/DC (50/60 Hz)	0.2 U <sub>N</sub>	
<b>Technical data</b>			
Mechanical life AC/DC	cycles	10 000 000	10 000 000
Electrical life at rated load AC-7a	cycles	150 000 (NO)/100 000 (NC)	150 000
B10d - AC1 (230 V - 32 A)		150 000	150 000
Operate/release time	ms	45/50	45/70
Insulation between coil and contacts (1.2/50 μs)	kV	4	4
Ambient temperature range	°C	See table Current - Temperature derating (page 9)	
Protection category		IP 20	IP 20
<b>Approvals</b> (according to type)		<b>CE UK EAC</b>	

### Ordering information

Example: 22 series, modular contactor 25 A, 4 NO contacts, coil 230 V AC/DC, AgSnO<sub>2</sub> contacts, Auto-On-Off selector + mechanical indicator + LED, standard version.

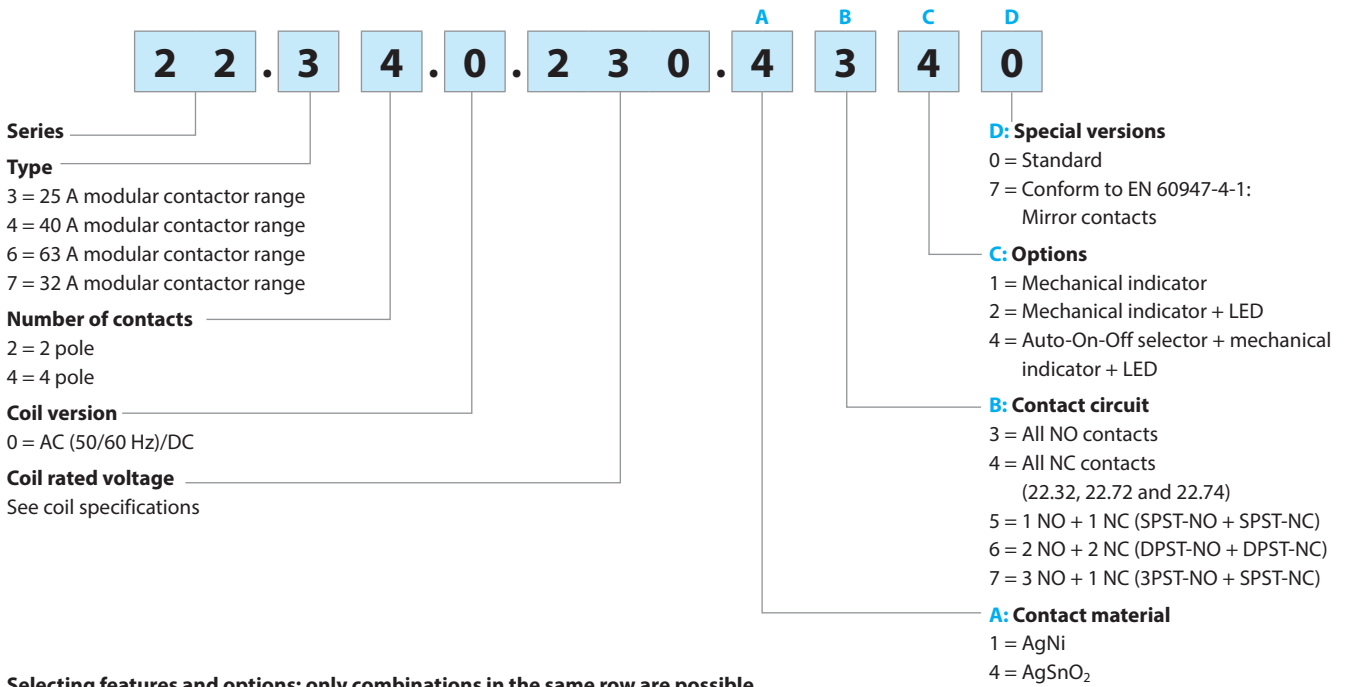

**Selecting features and options: only combinations in the same row are possible.**  
Preferred selections for best availability are shown in **bold**.

Type	Coil version	A	B	C	D
22.32	AC/DC	<b>1 - 4</b>	<b>3 - 4 - 5</b>	<b>2 - 4</b>	0
22.34	AC/DC	<b>1 - 4</b>	<b>3 - 6 - 7</b>	<b>2 - 4</b>	0
22.44	AC/DC	<b>4</b>	<b>3 - 6 - 7</b>	<b>1</b>	0 - 7
22.64	AC/DC	<b>4</b>	<b>3 - 6 - 7</b>	<b>1</b>	0 - 7
22.72	AC/DC	<b>1</b>	<b>3 - 4 - 5</b>	<b>1</b>	0 - 7
22.74	AC/DC	<b>1</b>	<b>3 - 4 - 6 - 7</b>	<b>1</b>	0 - 7



## Options

### 22.xx.x.xxx.xx4x – Auto-On-Off selector + mechanical indicator + LED (for Type 22.32 / 22.34)

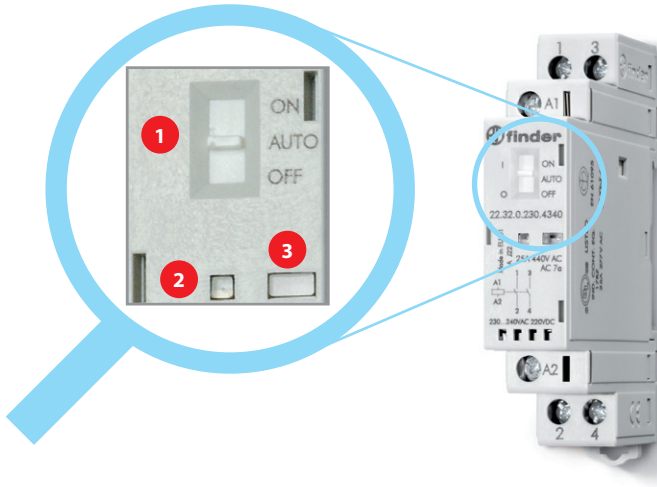

**1 Selector**

The three-position manual selector has the following functions:

- **ON position** - the contacts are latched in the operated state (NO contacts - closed and NC contacts - open), the mechanical indicator is visible in its window, the LED is not illuminated.
- **AUTO position** - the state of contacts, mechanical indicator and LED follow the coil supply voltage.
- **OFF position** - even if terminals A1 - A2 are supplied with rated voltage, the coil is not energized, and so the contacts remain in the non-operated state, the mechanical indicator is not visible and the LED is not illuminated.

**2 LED**

**3 Mechanical indicator**

### 22.xx.x.xxx.xx1x – Mechanical indicator (for Type 22.44 / 22.64 / 22.72 / 22.74)

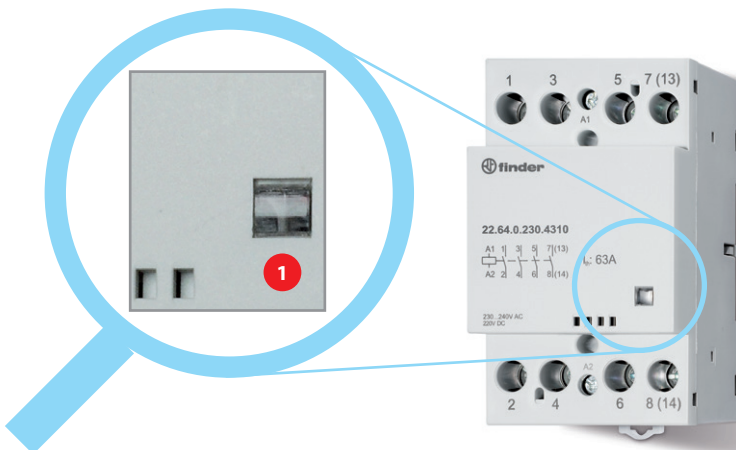

**1 Mechanical indicator**



## Technical data

Insulation		22.32/22.34		22.44/22.64	22.72/22.74
Rated insulation voltage	V AC	250	440	440	440
Pollution degree		3*	2	3	3
<b>Insulation between coil and contact set</b>					
Type of insulation		Reinforced		Reinforced	Reinforced
Overvoltage category		III		III	III
Rated impulse voltage	kV (1.2/50 μs)	6		4	4
Dielectric strength	V AC	4000		2000	2000
<b>Insulation between adjacent contacts</b>					
Type of insulation		Basic		Basic	Basic
Overvoltage category		III		III	III
Rated impulse voltage	kV (1.2/50 μs)	4		4	4
Dielectric strength	V AC	2500		2000	2000
<b>Insulation between open contacts</b>		<b>NO contact</b>	<b>NC contact</b>	<b>NO/NC contacts</b>	<b>NO/NC contacts</b>
Contact gap	mm	3	1.5	3	3
Overvoltage category		III	II	III	III
Rated impulse voltage	kV (1.2/50 μs)	4	2.5	4	4
Dielectric strength	V AC/kV (1.2/50 μs)	2500/4	2000/3	2000/3	2000
* Only for versions without Auto-On-Off selector. For versions with Auto-On-Off selector pollution degree 2 applies.					
<b>Insulation between coil terminals</b>					
Rated impulse voltage (surge) differential mode (according to EN 61000-4-5)	kV (1.2/50 μs)	4		2	2
<b>Short circuit protection</b>		<b>22.32 / 22.34</b>	<b>22.44</b>	<b>22.64</b>	<b>22.72/22.74</b>
Rated conditional short circuit current	kA	3	3	3	3
Back-up fuse	A	32 (gL/gG type)	63	80	32
<b>Terminals</b>		<b>Solid and stranded cable</b>			
		<b>22.32 / 22.34</b>	<b>22.44 / 22.64</b>	<b>22.72/22.74</b>	
Max. wire size – contact terminals	mm <sup>2</sup>	1 x 6 / 2 x 4		1 x 10 (solid) 1 x 6 (stranded)	
	AWG	1 x 10 / 2 x 12		1 x 4 (solid) - 1 x 6 (stranded)	
Max. wire size – coil terminals	mm <sup>2</sup>	1 x 4 / 2 x 2.5		1 x 2.5	
	AWG	1 x 12 / 2 x 14		1 x 14	
Min. wire size – contact and coil terminals	mm <sup>2</sup>	1 x 0.2		1 x 1 (coil) - 1 x 1.5 (contacts)	
	AWG	1 x 24		1 x 18 (coil) - 1 x 16 (contacts)	
Screw torque	Nm	0.8		1.2 (coil terminals) - 3.5 (contact terminals)	
Wire strip length	mm	9		10	
<b>Other data</b>		<b>22.32</b>	<b>22.34</b>	<b>22.44</b>	<b>22.64</b>
Vibration resistance (10...150)Hz	g	4	4	3	3
Shock resistance	g	10	10	15	15
Power lost to the environment	without contact current	W	2	6	6
	with rated current	W	4.8	6.3	17

### Note

**22.32/22.34:** It is suggested an air gap of 9 mm between adjacent relays for installations and working conditions close to the limit (that is, ambient temperature > 40 °C, coil operated for a prolonged period of time, all contacts loaded with current > 20 A).

**22.44/22.64:** The maximum ambient temperature with 3 adjacent contactors is + 40 °C; when more than 3 contactors are installed, it is necessary an air gap of 9 mm. With 2 adjacent contactors the maximum ambient temperature is + 55 °C; when more than 2 contactors are installed, it is necessary an air gap of 9 mm.

## Current - Temperature derating

Type of contactor		22.72	22.74	22.44	22.64
Rated current	A	32	32	40	63
Operating ambient temperature	-25 °C...+55°C(I <sub>N</sub> )...+70 °C (2NO contacts)	-25 °C...+55°C(I <sub>N</sub> )...+70 °C (4NO contacts)			
	-15 °C...+55 °C (1NO+1NC contacts)	-15 °C...+55°C(I <sub>N</sub> )...+70 °C (3NO+1NC contacts)			
	-15 °C...+55 °C (2NC contacts)	-15 °C...+55 °C (2NO+2NC contacts)			
	—	-15 °C...+55 °C (4NC contacts)		—	
Max. thermal current up to +55 °C	A	32	32	40	63
Max. thermal current @ +70 °C	A	25	25	40	50
Number of contactors side-by-side:	≤40 °C	max. 3			
	(40...55) °C	max. 2			
	(55...70) °C	max. 1 (ventilation module or least 9 mm free space on each side)			
Min. conductor @ thermal current @ +70 °C	mm <sup>2</sup>	6	6	10	16
Tightening torque - main circuit	Nm	1.2	1.2	3.5	3.5

## Contact specification

Ratings and utilization categories according to EN 61095: 2009

Type	Utilization category					
	AC-7a		AC-7b		AC-7c	
	Rated current (A)	Rated electrical life (Cycles)	Rated current (A)	Rated electrical life (Cycles)	Rated current (A)	Rated electrical life (Cycles)
22.32....1xx0 (AgNi contacts)	25	70 · 10 <sup>3</sup> (NO)	10	30 · 10 <sup>3</sup>	—	—
		30 · 10 <sup>3</sup> (NC)				
22.32....4xx0 (AgSnO <sub>2</sub> contacts)	25	30 · 10 <sup>3</sup>	10	30 · 10 <sup>3</sup>	10	30 · 10 <sup>3</sup>
22.34....1xx0 (AgNi contacts)	25	150 · 10 <sup>3</sup> (NO)	10	30 · 10 <sup>3</sup>	—	—
		100 · 10 <sup>3</sup> (NC)				
22.34....4xx0 (AgSnO <sub>2</sub> contacts)	25	30 · 10 <sup>3</sup>	10	30 · 10 <sup>3</sup>	10	30 · 10 <sup>3</sup>
22.44....4xx0	40	100 · 10 <sup>3</sup>	22	150 · 10 <sup>3</sup>	—	—
22.64....4xx0	63	100 · 10 <sup>3</sup>	30	150 · 10 <sup>3</sup>	—	—
22.72....1410	32	150 · 10 <sup>3</sup> (NO) - 100 · 10 <sup>3</sup> (NC)	9 (NO) / 6 (NC)	30 · 10 <sup>4</sup>	—	—
22.74....1410	32	150 · 10 <sup>3</sup>	8.5	50 · 10 <sup>4</sup>	—	—

Utilization category: **AC-7a** = Slightly inductive loads ( $\cos\phi = 0.8$ )

**AC-7b** = Motor loads; ( $\cos\phi = 0.45$ ,  $I_{making} = 6x I_{breaking}$ )

**AC-7c** = Compensated electric discharge lamps ( $\cos\phi = 0.9$ ,  $C = 10 \text{ mF/A}$ )

H 22 - Maximum DC1 breaking capacity - Type 22.32/22.34

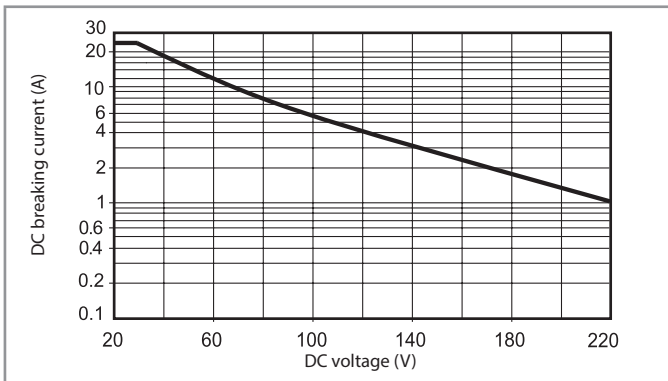

H 22 - Maximum DC1 breaking capacity - Type 22.44/22.64

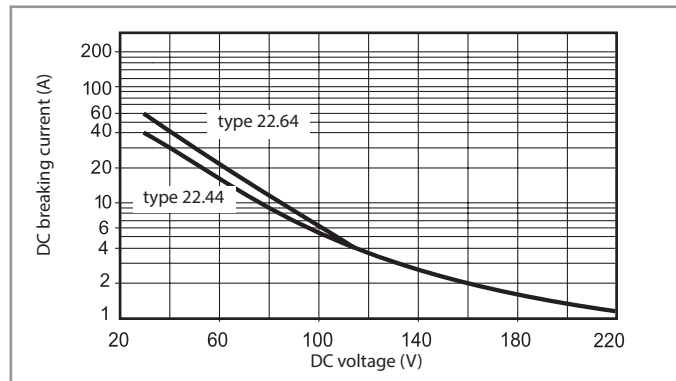

- When switching a resistive load (DC1) having voltage and current values under the curve, an electrical life of  $\geq 100 \cdot 10^3$  can be expected.
- In the case of DC13 loads, the connection of a diode in parallel with the load will permit a similar electrical life as for a DC1 load.  
Note: the release time for the load will be increased.

H 22 - Maximum DC1 breaking capacity - Type 22.72/22.74

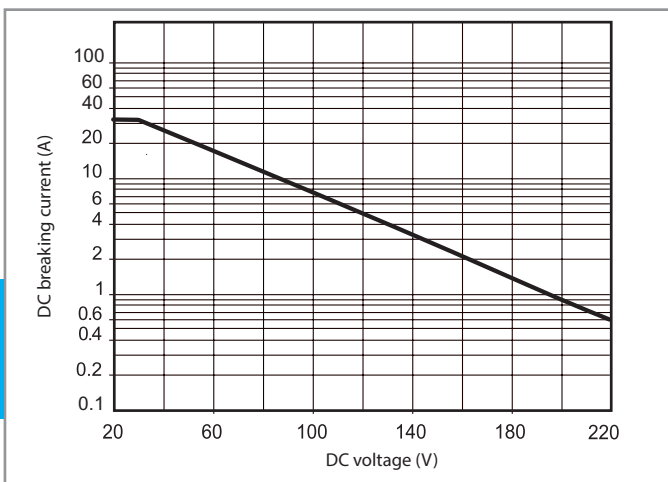

### Coil specifications

AC/DC version data (type 22.32)

Nominal voltage $U_N$ V	Coil code	Operating range		Rated coil consumption $I_N$ at $U_N$ (AC) mA
		$U_{min}$ V	$U_{max}$ V	
12	0.012	9.6	13.2	165
24	0.024	19.2	26.4	83
48	0.048	38.4	52.8	42
60	0.060	48	66	33
120 (110...125)	0.120	88	138	16.5
230 (230...240 AC) (220 DC)	0.230	184 (AC) 176 (DC)	264 (AC) 242 (DC)	8.7

AC/DC version data (type 22.34)

Nominal voltage $U_N$ V	Coil code	Operating range		Rated coil consumption $I_N$ at $U_N$ (AC) mA
		$U_{min}$ V	$U_{max}$ V	
12	0.012	9.6	13.2	165
24	0.024	19.2	26.4	83
48	0.048	38.4	52.8	42
60	0.060	48	66	33
120 (110...125)	0.120	88	138	16.5
230 (230...240 AC) (220 DC)	0.230	184 (AC) 176 (DC)	264 (AC) 242 (DC)	8.7

AC/DC version data (type 22.44 / 22.64)

Nominal voltage $U_N$ V	Coil code	Operating range		Rated coil consumption $I_N$ at $U_N$ (AC) mA
		$U_{min}$ V	$U_{max}$ V	
12	0.012	10.2	13.2	495
24	0.024	20.4	26.4	250
120 (110...125)	0.120	102	138	50
230 (230...240 AC) (220 DC)	0.230	196	264 (AC) 242 (DC)	26

AC/DC version data (type 22.72)

Nominal voltage $U_N$ V	Coil code	Operating range		Rated coil consumption $I_N$ at $U_N$ (AC) mA
		$U_{min}$ V	$U_{max}$ V	
24	0.024	20.4	26.4	98
48	0.048	40.8	52.8	44
110	0.110	93.5	121	20
230	0.230	195.5	253	9.2

AC/DC version data (type 22.74)

Nominal voltage $U_N$ V	Coil code	Operating range		Rated coil consumption $I_N$ at $U_N$ (AC) mA
		$U_{min}$ V	$U_{max}$ V	
24	0.024	20.4	26.4	110
48	0.048	40.8	52.8	54.6
110	0.110	93.5	121	24.5
230	0.230	195.5	253	10.8

R 22 - Coil operating range v ambient temperature

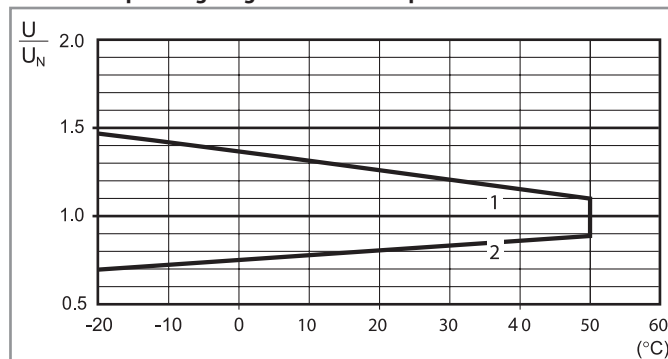

- 1 - Max. permitted coil voltage.
- 2 - Min. pick-up voltage with coil at ambient temperature.

Wiring diagrams

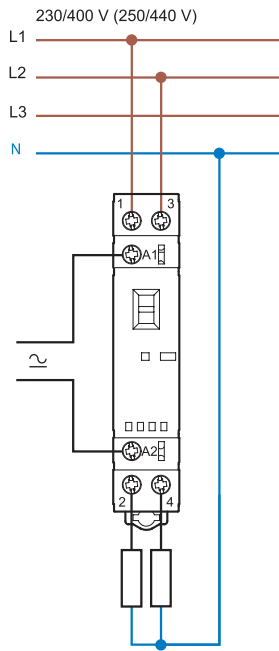

Type 22.32

Line and neutral switched

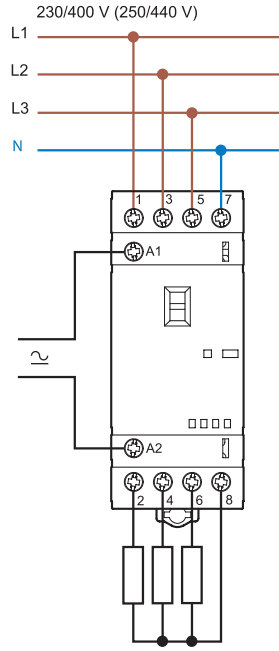

Type 22.34

Line only switched

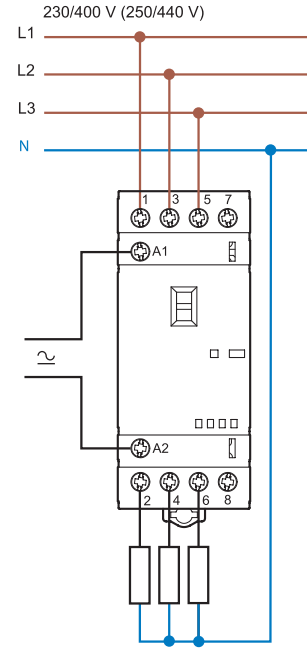

Type 22.34

Line and neutral switched

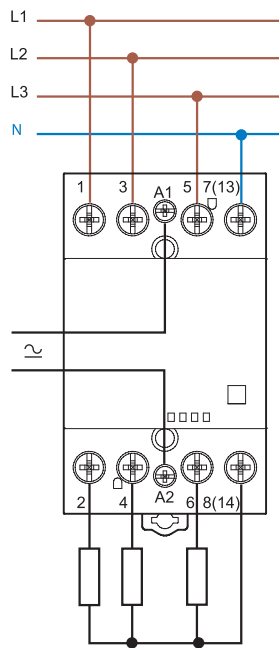

Type 22.44/22.64

Line only switched

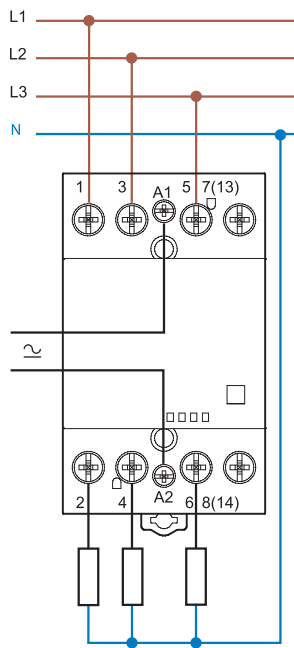

Type 22.44/22.64

Mirror Contacts

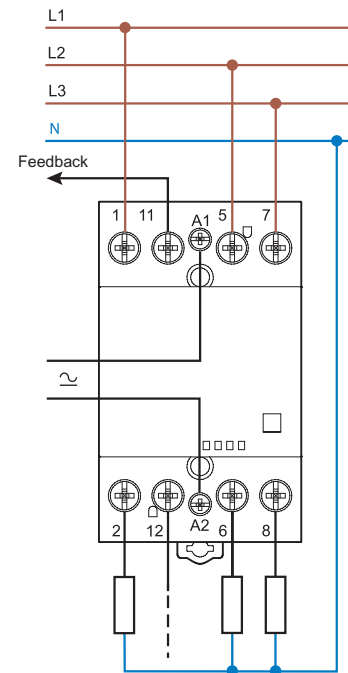

Type 22.xx.4717

Example of application of contactor with Mirror Contacts: Normally closed contact is definitely in open position if the normally open contact is closed

### Wiring diagrams

#### Phase interruption only

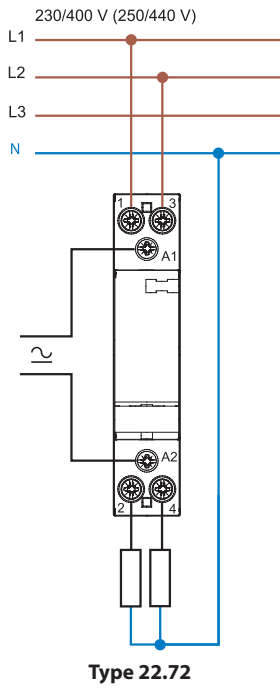

#### Phase and neutral interruption

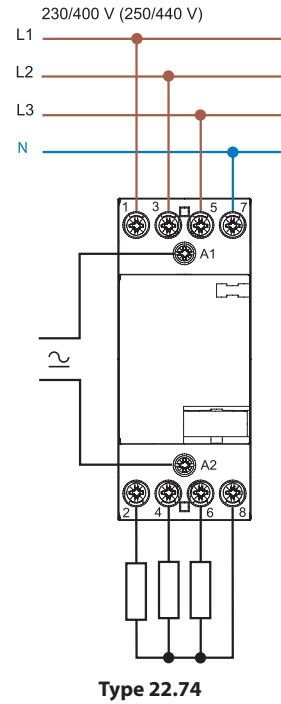

Outline drawings

Type 22.32  
Screw terminal

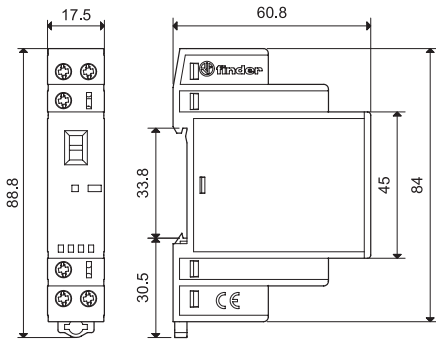

Types 22.32 + 022.33/022.35  
Screw terminal

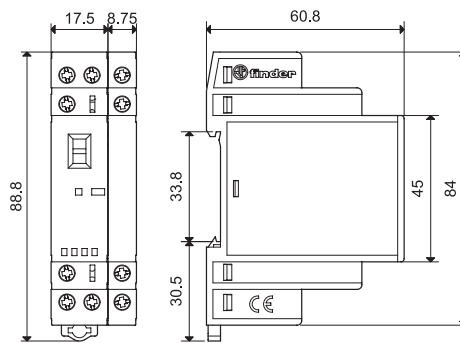

Type 22.34  
Screw terminal

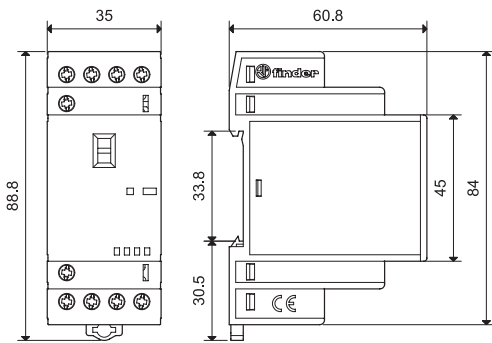

Types 22.34 + 022.33/022.35  
Screw terminal

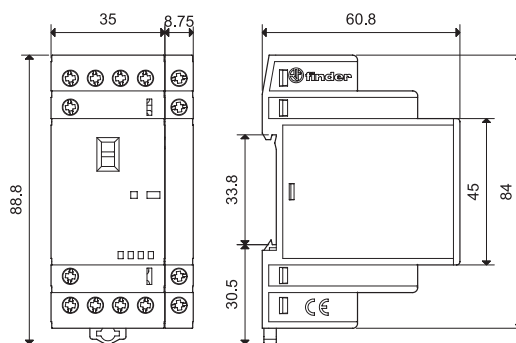

Types 22.44/22.64  
Screw terminal

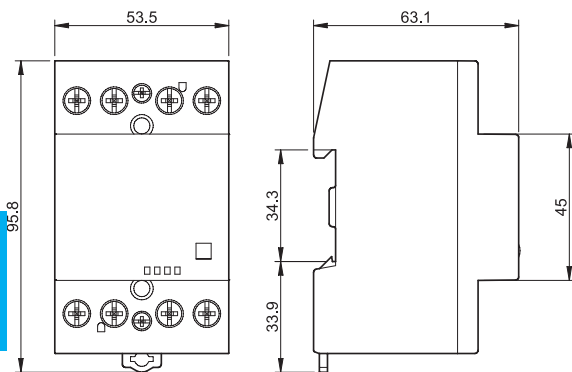

Types 22.44/22.64 + 022.63/022.65  
Screw terminal

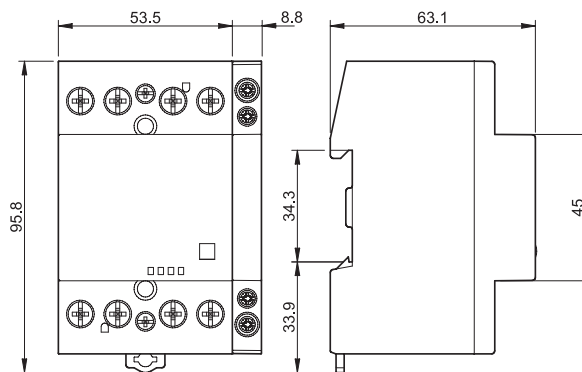

Outline drawings

Types 022.33/022.35  
Screw terminal

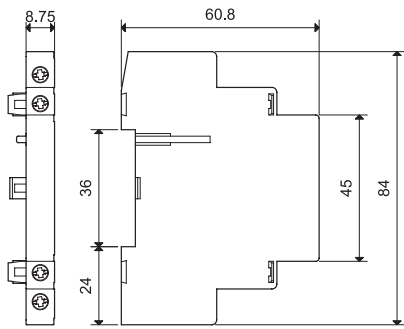

Types 022.63/022.65  
Screw terminal

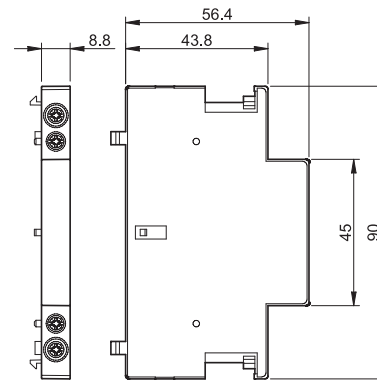

Type 22.72  
Screw terminal

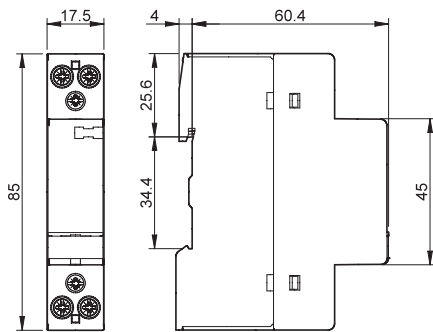

Types 22.74  
Screw terminal

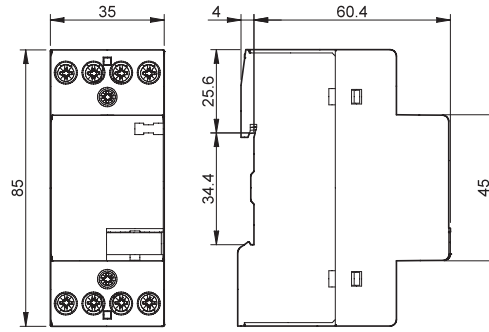

**Auxiliary modules**

Mechanically linked contacts according to Annex L of EN 60947-5-1

	022.33	022.35	022.63	022.65	022.7x
					<b>022.73</b>  <b>022.75</b> 
Type of contactor	Type 22.32 Type 22.34		Type 22.44 Type 22.64		Type 22.74
<b>Contact specification</b>					
Contact configuration	2 NO	1 NO + 1 NC	2 NO	1 NO + 1 NC	2 NO   1 NO + 1 NC
Conventional free air thermal current I <sub>th</sub> A	6		6		6
Rated power AC15 (230 V) VA	700		700		700
Electrical life at rated load cycles	30 · 10 <sup>3</sup>		30 · 10 <sup>3</sup>		30 · 10 <sup>3</sup>
Minimum switching load mW (V/mA)	1000 (10/10)		1000 (10/10)		1000 (10/10)
Contact material	AgNi		AgNi		AgNi
<b>Short circuit protection</b>					
Rated conditional short circuit current kA	1		1		1
Back-up fuse A	6 (gL/gG type)		6 (gL/gG type)		6 (gL/gG type)
<b>Terminals</b>	<b>Solid and stranded cable</b>		<b>Solid and stranded cable</b>		<b>Solid and stranded cable</b>
Max. wire size mm <sup>2</sup>	1 x 4 / 2 x 2.5		1 x 2.5		1 x 2.5
AWG	1 x 12 / 2 x 14		1 x 14		1 x 14
Min. wire size mm <sup>2</sup>	1 x 0.2		1 x 1		1 x 1
AWG	1 x 24		1 x 18		1 x 18
⊕ Screw torque Nm	0.6		0.6		0.6
Wire strip length mm	9		9		9
<b>Power lost to the environment</b>					
without contact current W	—		—		—
with rated current W	0.5		0.5		0.5
<b>Approvals</b> (according to type)					

NOTE: It is not possible to assembly the auxiliary module on 22.32.0.xxx.x4x0 (2 NC versions).



22.32 + 022.33/022.35



22.44 + 022.63/022.65



22.34 + 022.33/022.35



22.64 + 022.63/022.65



Accessories



020.01

**Adaptor for panel mounting (for 22.32 type), plastic, 17.5 mm wide**

020.01

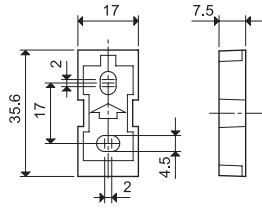

011.01

**Adaptor for panel mounting (for 22.34 type), plastic, 35 mm wide**

011.01

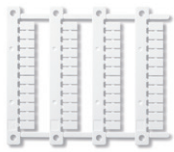
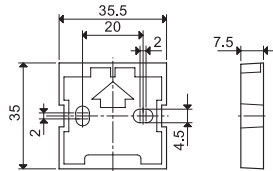

060.48

**Sheet of marker tags (CEMBRE Thermal transfer printers) for all relays (48 tags), 6 x 12 mm**

060.48



019.01

**Identification tag, plastic, 1 tag, 17x25.5 mm**

019.01



022.09

**Separator for rail mounting, plastic, 9 mm wide**

022.09

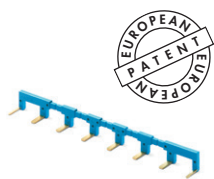
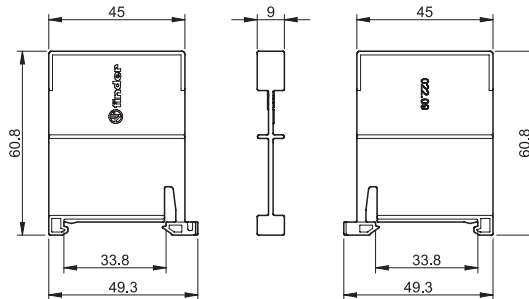

022.18



**8-way jumper link for type 22.32, 17.5 mm wide**

022.18 (blue)

Rated values

10 A - 250 V

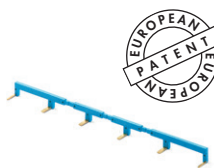
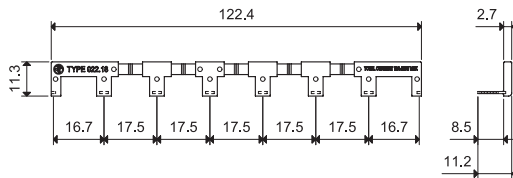

022.26



**6-way jumper link for type 22.34, 35 mm wide**

022.26 (blue)

Rated values

10 A - 250 V

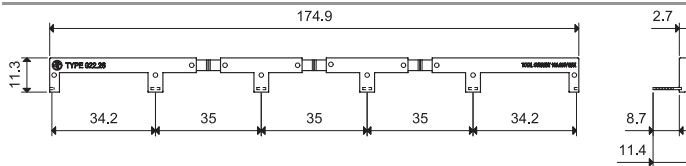



# Modular mono-stable relays 20 A



Hotel room energy-enabling units



Garden and night lighting



Streetlights and car park lighting



Bathrooms lighting control



Office lighting control



Pump control



**22**  
SERIES



**1 or 2 pole, 20 A relay  
for direct 35 mm rail (EN 60715) mounting**

- 17.4 mm wide
- Test button
- Identification label
- AC coils and DC coils
- 35 mm rail (EN 60715) mount
- Cadmium free contact material

22.21/22

Screw terminals



**22.21**



**22.22**



- Single phase switch 1 NO (SPST-NO)
- 35 mm rail (EN 60715) mount

- Double phase switch 2 NO (DPST-NO)
- 35 mm rail (EN 60715) mount



For outline drawing see page 6

**Contact specification**

Contact configuration	1 NO (SPST-NO)	2 NO (DPST-NO)
Rated current/Maximum peak current	A	20/30
Rated voltage/ Maximum switching voltage	V AC	250/400
Rated load AC1	VA	5000
Rated load AC15 (230 V AC)	VA	1000
Single phase motor rating (230 V AC)	kW	—
Breaking capacity DC1: 24/110/220 V	A	20/0.3/0.12
Nominal lamp rating:		
230 V incandescent/halogen W	1000	1000
fluorescent tubes with electronic ballast W	400	400
fluorescent tubes with electromagnetic ballast W	360	360
CFL W	200	200
230 V LED W	200	200
LV halogen or LED with electronic ballast W	200	200
LV halogen or LED with electromagnetic ballast W	400	400
Minimum switching load	mW (V/mA)	1000 (10/10)
Standard contact material		AgSnO <sub>2</sub>

**Coil specification**

Nominal voltage (U <sub>N</sub> )	V AC (50/60 Hz)	12 - 24 - 230	
	V DC	12 - 24	12 - 24
Rated power AC/DC	VA (50 Hz)/W	3/1.25	3/1.25
Operating range	AC (50 Hz)	(0.85...1.1)U <sub>N</sub>	(0.85...1.1)U <sub>N</sub>
	DC	(0.9...1.1)U <sub>N</sub>	(0.9...1.1)U <sub>N</sub>

**Technical data**

Mechanical life AC/DC	cycles	500 · 10 <sup>3</sup>	500 · 10 <sup>3</sup>
Electrical life at rated load in AC1	cycles	50 · 10 <sup>3</sup>	50 · 10 <sup>3</sup>
Operate/release time	ms	15/8	15/8
Maximum impulse duration		continuous	continuous
Insulation between coil and contacts (1.2/50 μs)	kV	4	4
Ambient temperature range	°C	-40...+40	-40...+40
Protection category		IP 20	IP 20

**Approvals relay** (according to type)



**1 or 2 pole, 20 A relay  
for direct 35 mm rail (EN 60715) mounting**

- 17.4 mm wide
- Test button
- Identification label
- AC coils and DC coils
- 35 mm rail (EN 60715) mount
- Cadmium free contact material

22.23/24  
Screw terminals

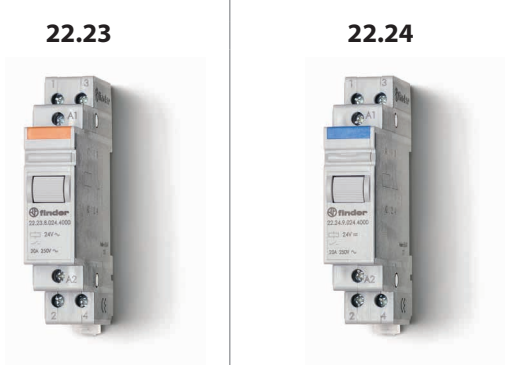

- Double phase switch 1 NO + 1 NC (SPST-NO + SPST-NC)
- 35 mm rail (EN 60715) mount
- Double phase switch 2 NC (DPST-NC)
- 35 mm rail (EN 60715) mount

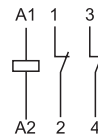

For outline drawing see page 6

<b>Contact specification</b>		22.23	22.24
Contact configuration		1 NO + 1 NC (SPST-NO + SPST-NC)	2 NC (DPST-NC)
Rated current/Maximum peak current	A	20/30	20/30
Rated voltage/ Maximum switching voltage	V AC	250/400	250/400
Rated load AC1	VA	5000	5000
Rated load AC15 (230 V AC)	VA	1000	1000
Single phase motor rating (230 V AC)	kW	—	—
Breaking capacity DC1: 24/110/220 V	A	20/0.3/0.12	20/0.3/0.12
Nominal lamp rating:			
230 V incandescent/halogen W		1000	1000
fluorescent tubes with electronic ballast W		400	400
fluorescent tubes with electromagnetic ballast W		360	360
CFL W		200	200
230 V LED W		200	200
LV halogen or LED with electronic ballast W		200	200
LV halogen or LED with electromagnetic ballast W		400	400
Minimum switching load	mW (V/mA)	1000 (10/10)	1000 (10/10)
Standard contact material		AgSnO <sub>2</sub>	AgSnO <sub>2</sub>
<b>Coil specification</b>		22.23	22.24
Nominal voltage (U <sub>N</sub> )	V AC (50/60 Hz)	12 - 24 - 230	
	V DC	12 - 24	12 - 24
Rated power AC/DC	VA (50 Hz)/W	3/1.25	3/1.25
Operating range	AC (50 Hz)	(0.85...1.1)U <sub>N</sub>	(0.85...1.1)U <sub>N</sub>
	DC	(0.9...1.1)U <sub>N</sub>	(0.9...1.1)U <sub>N</sub>
<b>Technical data</b>		22.23	22.24
Mechanical life AC/DC	cycles	500 · 10 <sup>3</sup>	500 · 10 <sup>3</sup>
Electrical life at rated load in AC1	cycles	50 · 10 <sup>3</sup>	50 · 10 <sup>3</sup>
Operate/release time	ms	15/8	15/8
Maximum impulse duration		continuous	continuous
Insulation between coil and contacts (1.2/50 μs)	kV	4	4
Ambient temperature range	°C	-40...+40	-40...+40
Protection category		IP 20	IP 20
<b>Approvals relay</b> (according to type)			

## Ordering information

Example: 22 series, 35 mm rail mount relay, 1 NO (SPST-NO) 20 A contact, coil rated 24 V DC, contact material AgSnO<sub>2</sub>.

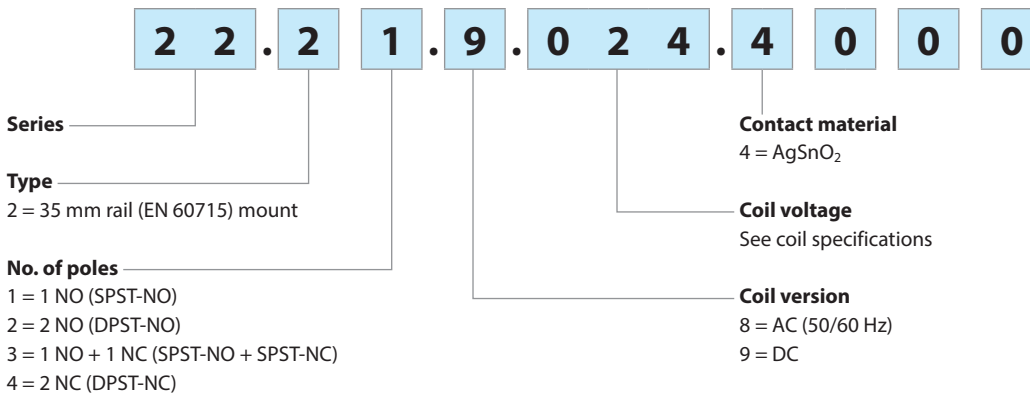

## Technical data

Insulation					
Dielectric strength					
between supply and contacts	V AC	3500			
between open contacts	V AC	2000			
between adjacent contacts	V AC	2000			
Other data					
Bounce time: NO/NC	ms	5/10			
Power lost to the environment					
without contact current	W	1.2			
with rated current	W	3.2 (22.21, 22.23)	5.2 (22.22, 22.24)		
Screw torque	Nm	0.8	0.8		
Max. wire size	<b>Coil terminals</b>		<b>Contact terminals</b>		
		solid cable	stranded cable	solid cable	stranded cable
	mm <sup>2</sup>	1 x 4 / 2 x 2.5	1 x 2.5 / 2 x 2.5	1 x 6 / 2 x 6	1 x 6 / 2 x 4
	AWG	1 x 12 / 2 x 14	1 x 14 / 2 x 14	1 x 10 / 2 x 10	1 x 10 / 2 x 12

If the coil is operated for a prolonged period of time, adequate ventilation of the relays must be provided - suggested gap of 9 mm between adjacent relays.

## Coil specifications

### DC version data

Nominal voltage	Coil code	Operating range		Resistance	Consumption
		U <sub>min</sub>	U <sub>max</sub>		
V		V	V	Ω	I at U <sub>N</sub> mA
12	9.012	10.8	13.2	115	104
24	9.024	21.6	24.6	460	52.2

### AC version data

Nominal voltage	Coil code	Operating range		Resistance	Consumption
		U <sub>min</sub>	U <sub>max</sub>		
V		V	V	Ω	I at U <sub>N</sub> (50 Hz) mA
12	8.012	10.2	13.2	13.5	245
24	8.024	20.4	26.4	41	135
230	8.230	196	253	4200	12.5

Outline drawing

Type 22.21  
Screw terminal

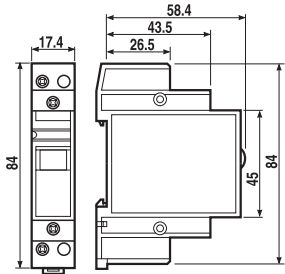

Type 22.22  
Screw terminal

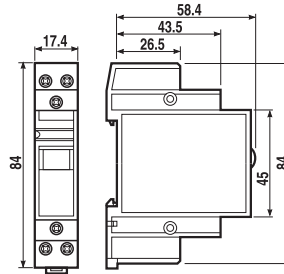

Type 22.23  
Screw terminal

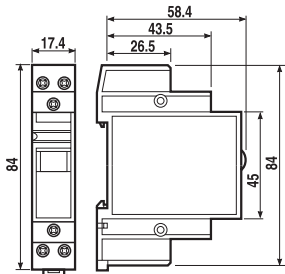

Type 22.24  
Screw terminal

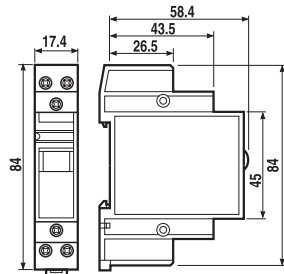

Accessories



020.01

Adaptor for panel mounting, 17.5 mm wide

020.01



022.09

Separator for rail mounting, plastic, 9 mm wide

022.09

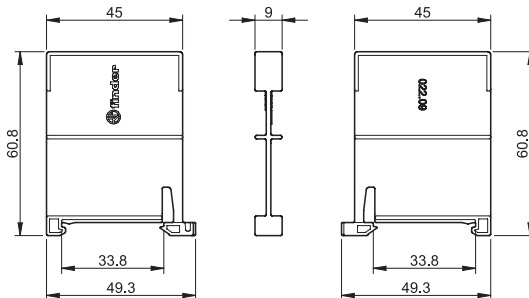



# Thermostats



Comfort



Energy savings



Ecological



Flexibility



Heating and cooling



Building automation





**Thermostat**

- Touch display with guided programming
- Stunning design
- Backlit touch keys
- Power supply: 2 1.5 V AA batteries
- 2 selectable temperatures (day/night)
- Summer/Winter switch
- PIN lock padlock function
- Temperature setting range 5-37°C
- Contact rating 5 A 250 V AC

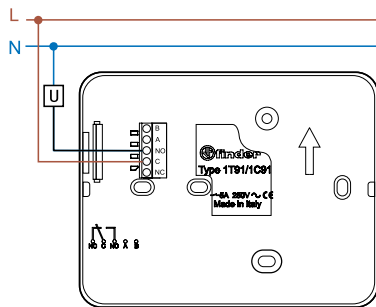

Wiring diagram

**NEW** 1T.91 BLISS<sub>T</sub>

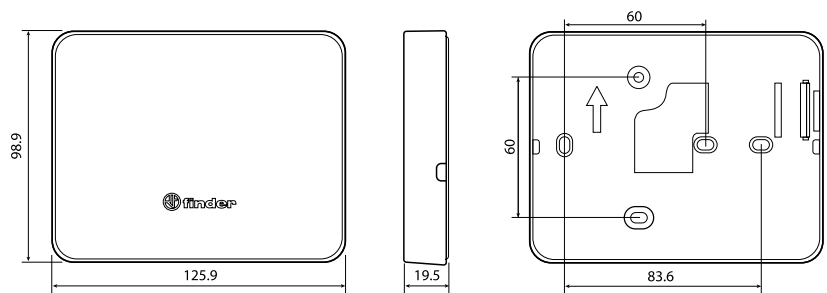

Colour	Thermostat
White	1T.91.9.003.0000
Technical features	
Sensing element	NTC
Supply	2 batteries 1.5 V AA
Contact configuration	1 CO (SPDT)
Contact rating	5 A/250 V AC
Display range	0...+50 °C
Temperature setting range	+5...+37 °C
Temperature differential	0.2 °C self regulation
Temperature rate of change	—
Nighttime set-back	YES
Independently set temperature levels	2 (day/night)
Thermostat lock	3 digit PIN
Protection category	IP 20
Mounting	Wall
Temperature resolution	0.1 °C
Accuracy at +20 °C	+/-0.5 °C
Frost Protection	+5 °C
Energy saving function	—
Push buttons	Backlit touch keys
Supervisory control	NO
Back-light display	YES
<b>Approvals</b> (according to type)	<b>CE UK EAC</b>

**Digital room thermostat**

- Independently set temperatures for Day and Night
- Temperature range (+5...+37)°C
- Supply voltage: 3 V DC (2 batteries 1.5 V DC AAA)
- Thermostat lock
- Functions: OFF (with Frost protection)/ Summer/Winter
- Frost protection range (+2...+8)°C
- 1 changeover 5 A/250 V AC output
- On/Off hysteresis selectable (0.2 - 0.5)°C

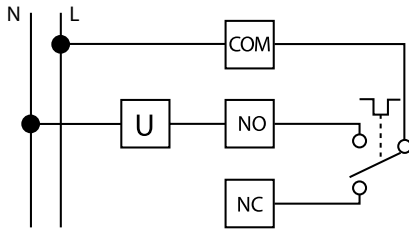

Wiring diagram

**1T.31**

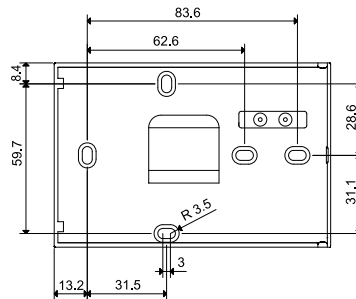
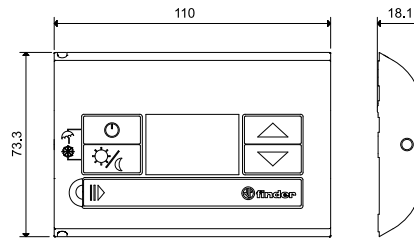
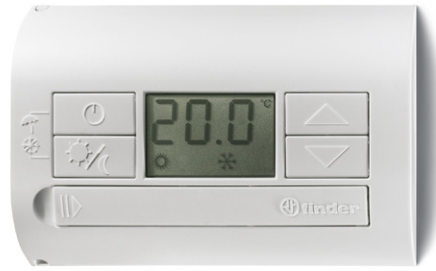

<b>Colour</b>	
White	1T.31.9.003.0000
Black	1T.31.9.003.2000
<b>Technical features</b>	
Sensing element	NTC
Supply	2 batteries 1.5 V AAA
Contact configuration	1 CO (SPDT)
Contact rating	5 A/250 V AC
Display range	0...+50 °C
Temperature setting range	+5...+37 °C
Temperature differential	0.2 - 0.5 °C
Temperature rate of change	—
Nighttime set-back	YES
Independently set temperature levels	2 (day/night)
Thermostat lock	Push buttons
Protection category	IP 20
Mounting	Surface
Temperature resolution	0.1 °C
Accuracy at +20 °C	+/-0.5 °C
Frost Protection	+2...+8 °C
Energy saving function	—
Push buttons	Mechanical
Supervisory control	NO
Back-light display	NO
<b>Approvals</b> (according to type)	<b>CE UK EAC</b>

**Digital room thermostat**

- Temperature regulation from 5 to 33 °C
- Supply voltage: 3 V DC  
(2 batteries 1.5 V DC AAA)
- Functions: OFF (with Frost protection)/  
Summer/Winter
- Programming: Day/Night (set-back by -3 °C)
- 1 changeover 5 A/250 V AC output
- Temperature setting range can be restricted, by  
internal mechanical blocking
- Display with:
  - Set temperature, actual temperature
  - Low battery
  - SUMMER/WINTER setting active
  - Heater/Air-conditioning ON

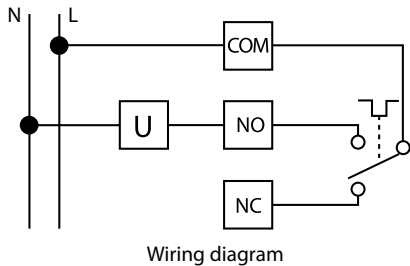

**1T.41**

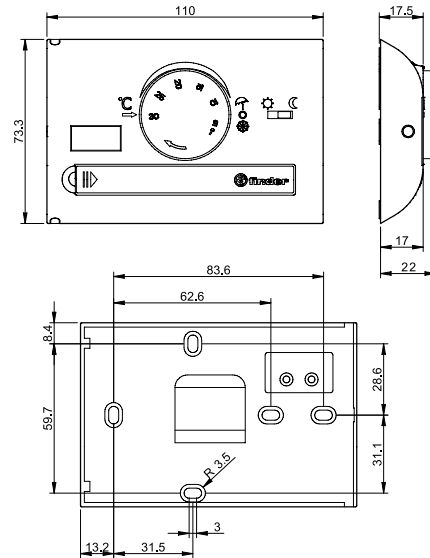

<b>Colour</b>	
White	1T.41.9.003.0000
Black	1T.41.9.003.2000
<b>Technical features</b>	
Sensing element	NTC
Supply	2 batteries 1.5 V AAA
Contact configuration	1 CO (SPDT)
Contact rating	5 A/250 V AC
Display range	0...+50 °C
Temperature setting range	+8...+30 °C (night set-back: <b>Winter</b> +5...+27 °C/ <b>Summer</b> +11...+33 °C)
Temperature differential	0.3 °C
Temperature rate of change	—
Nighttime set-back	YES (0.3 °C)
Independently set temperature levels	—
Thermostat lock	Mechanical
Protection category	IP 20
Mounting	Surface
Temperature resolution	0.1 °C
Accuracy at +20 °C	+/-0.5 °C
Frost Protection	5 °C
Energy saving function	—
Push buttons	Mechanical
Supervisory control	NO
Back-light display	NO
<b>Approvals</b> (according to type)	<b>CE UK EAC ENEC</b>

**Room thermostat**

- Temperature regulation (+7...+30)°C
- System operating - indicator light

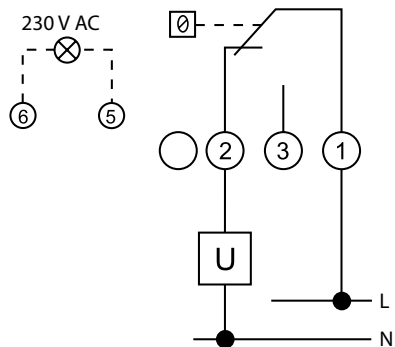

Wiring diagram

**1T.01.0**

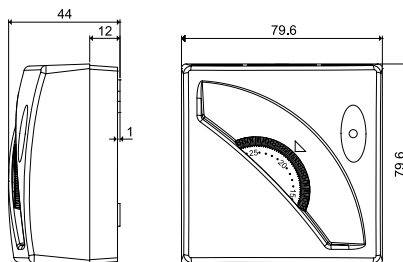

<b>Colour</b>	
White	1T.01.0
<b>Technical features</b>	
Sensing element	Gas bulb
Supply	—
Contact configuration	1 CO (SPDT)
Contact rating	16 A/250 V AC
Display range	—
Temperature setting range	+7...+30 °C
Temperature differential	0.4 - 0.8 °C
Temperature rate of change	1 °C/15 min
Nighttime set-back	—
Independently set temperature levels	—
Thermostat lock	Mechanical
Protection category	IP 20
Mounting	Surface
Temperature resolution	—
Accuracy at +20 °C	—
Frost Protection	—
Energy saving function	—
Push buttons	—
Supervisory control	NO
Back-light display	NO
<b>Approvals</b> (according to type)	

**Room thermostat with ON/OFF switch**

- ON/OFF switch
- Temperature regulation (+7...+30)°C
- System operating - indicator light

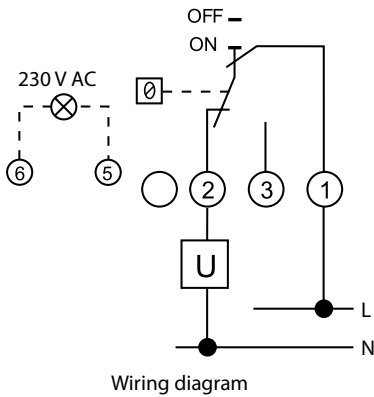

**1T.01.1**

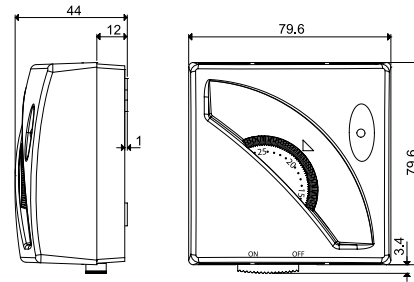

**Colour**

White

1T.01.1

**Technical features**

Sensing element	Gas bulb
Supply	—
Contact configuration	1 CO (SPDT)
Contact rating	16 A/250 V AC
Display range	—
Temperature setting range	+7...+30 °C
Temperature differential	0.4 - 0.8 °C
Temperature rate of change	1 °C/15 min
Nighttime set-back	—
Independently set temperature levels	—
Thermostat lock	Mechanical
Protection category	IP 20
Mounting	Surface
Temperature resolution	—
Accuracy at +20 °C	—
Frost Protection	—
Energy saving function	—
Push buttons	—
Supervisory control	NO
Back-light display	NO

**Approvals** (according to type)



**Room thermostat with SUMMER/WINTER switch**

- SUMMER/WINTER switch
- Temperature regulation (+7...+30)°C
- System operating - indicator light

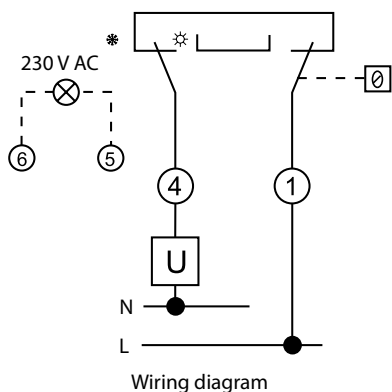
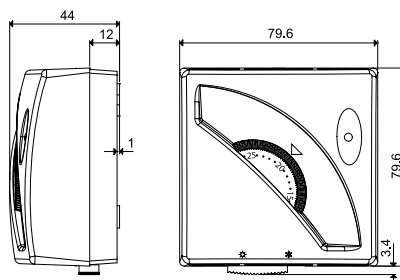
**1T.01.2**

Colour	
White	1T.01.2
Technical features	
Sensing element	Gas bulb
Supply	—
Contact configuration	1 CO (SPDT)
Contact rating	16 A/250 V AC
Display range	—
Temperature setting range	+7...+30 °C
Temperature differential	0.4 - 0.8 °C
Temperature rate of change	1 °C/15 min
Nighttime set-back	—
Independently set temperature levels	—
Thermostat lock	Mechanical
Protection category	IP 20
Mounting	Surface
Temperature resolution	—
Accuracy at +20 °C	—
Frost Protection	—
Energy saving function	—
Push buttons	—
Supervisory control	NO
Back-light display	NO
<b>Approvals</b> (according to type)	<b>CE UK EAC</b>



# Digital chronothermostats



Geolocation



Comfort



Energy  
savings



Ecological



Flexibility



Heating and  
cooling



Building  
automation





**Smart thermostat BLISS2**

- Remote management via the app (Android or iOS) thanks to the Wi-Fi GATEWAY, 1Y.GU.005.1
- Without internet connection, the BLISS2 can be set up via GATEWAY using the Bluetooth communication
- Stunning design LED matrix display
- Touch keys
- 3x batteries, type AAA (estimated electrical life of 1.5 years)
- Timed manual operation from 1 hour to 99 hours, or permanent mode
- Summer/winter function
- Temperature setting +5...+37°C
- Humidity sensor 1%...99%
- Contact rating 5 A 250 V AC
- Perfect for direct surface mounting or installation over "503" or 60 mm round wall boxes

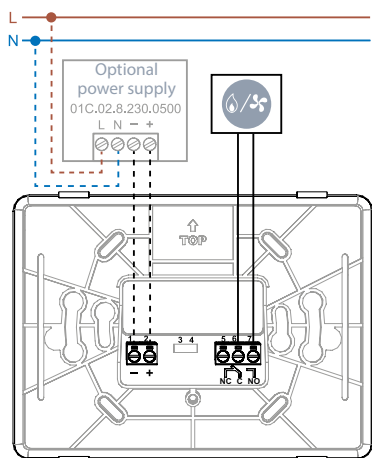

**NEW 1C.B1 BLISS2**

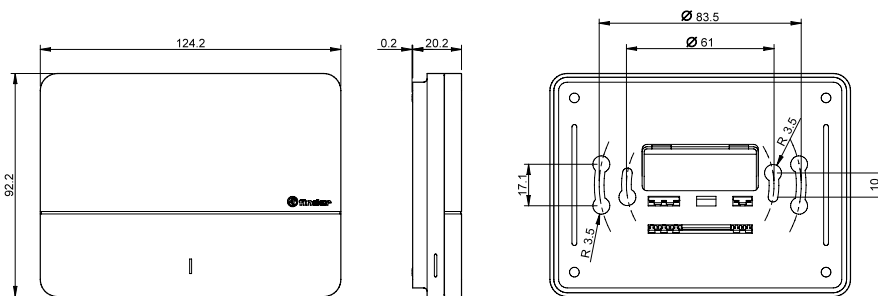

**Colour**

White

**Smart thermostat BLISS2**

1C.B1.9.005.0007

**Technical features**

Sensing element	Electronic sensor
Supply	3 batteries 1.5 V AAA or with optional external power supply (page 4)
Contact configuration	1 CO (SPDT)
Contact rating	5 A/250 V AC
Display range	0...+50 °C
Temperature setting range	+5...+37 °C
Temperature differential	0.1...0.9 °C / settable by app
Humidity sensor	1...99%
Nighttime set-back	—
Independently set temperature levels	from 5...37 °C
Thermostat lock	Temperature range
Protection category	IP 20
Mounting	Surface
Temperature resolution	0.1 °C
Accuracy at +20 °C	+/-0.5 °C
Frost Protection	+5 °C
Weekly/Daily	Weekly settable via app
Minimum programming interval	1 minute
Energy saving function	Geolocation
Push buttons	Touch keys
Back-light display	YES
Communications	868MHz RF and Wi-Fi via GATEWAY Type 1Y.GU.005.1
App programming	YES
<b>Approvals</b> (according to type)	<b>CE UK EAC</b>



# BLISS2

## With BLISS2

- Read the room Relative Humidity value
- Program the thermostat in manual mode
- Manage the thermostat remotely via the Finder YOU app
- Manage the room temperature through voice assistants

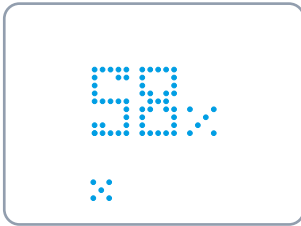

%HR

Display of Relative Humidity currently present in the atmosphere.



ROOM TEMPERATURE

Thermostat is set to AUTOMATIC mode (AUTO) and will respond to programming via the app.

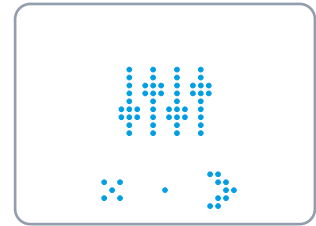

SETTINGS MENU

From here you can access the device settings.

## Type 1Y.GU.005.1 Second generation GATEWAY

# GATEWAY



The second generation GATEWAY (1Y.GU.005.1) integrates perfectly with Finder's YESLY comfort living system and BLISS2.

With the installation of GATEWAY, BLISS2 and other Finder smart home YESLY products you have the ability to check or change your home's temperature, turn on the lights, close the shutters, or recall customized scenarios via Wi-Fi, all by using the dedicated Finder YOU app.



**And importantly, even with the loss of the Wi-Fi network your BLISS2 and YESLY devices will still be controllable via Bluetooth.**

**Up to 10 BLISS2 can be paired with each GATEWAY**



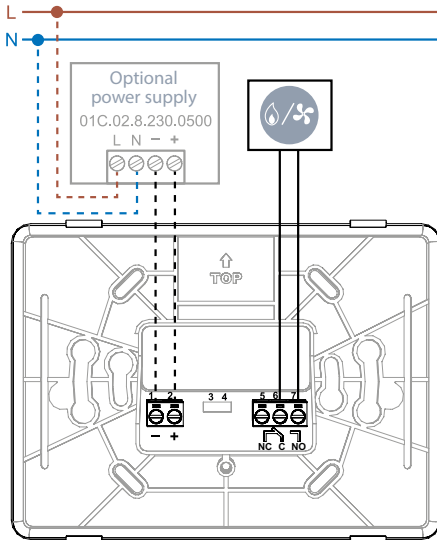

### Type 01C.02.8.230.0500 Power supply for smart thermostat BLISS2

**This power supply is perfect for installations with multiple thermostats, in both the residential and commercial sectors. In particular: hotel, B&B, offices and similar.**

- Rated power: 2 W
- Nominal voltage: 110...230 V AC
- Output voltage: 5 V DC
- Ambient temperature range: 0...40°C
- Maximum cable length between power supply and BLISS2:  
40 m (2x1.5 mm<sup>2</sup> flexible cable)

When using the smart thermostat BLISS2 with the external power supply, the batteries **MUST** be removed.



#### With Finder YOU app

- Remotely manage the thermostat easily and intuitively
- Create and edit weekly time schedules
- Share and manage your thermostat from multiple smartphones and different users
- Control multiple thermostats within the same house or in different homes
- Check the working time of the heating system and monitor its performance by viewing the deviation between the set and measured temperatures
- Set the AUTO-AWAY geolocation energy saving function



The BLISS2 thermostat is available in two different packs:



**Packaging code: 1C.B1.9.005.0007.POA**

This bundle contains 1 BLISS2 thermostat + 1 GATEWAY.  
The GATEWAY is essential for working in smart mode, and is able to pair with up to 10 BLISS2 devices.



**BLISS2**  
Thermostat  
1C.B1.9.005.0007



**GATEWAY**  
GATEWAY  
1Y.GU.005.1



**Packaging code: 1C.B1.9.005.0007**

This package contains a single BLISS2 thermostat and is for those who need to install multiple devices and are already in possession of the appropriate GATEWAY.

**Easily replace your old wall-mounted thermostat**

BLISS2 is a simple solution for replacing an existing thermostat whether it be powered by a battery or wired to a power supply, or whether it is directly surface mounted or fitted on an electrical wall box.

To use BLISS2 in smart mode, simply connect the GATEWAY to the electrical socket and pair the devices via the Finder YOU app. You can replace any Finder or other brand of thermostat\*.

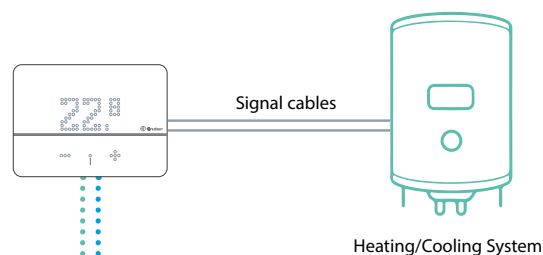
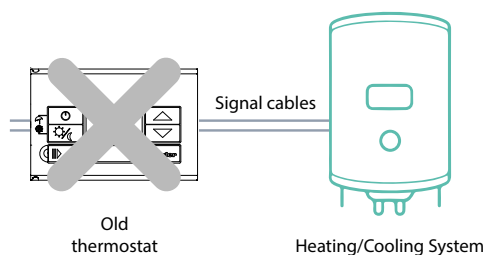

\* For thermostats with equivalent underlying functionality. For more information or assistance, contact our local sales office or toll-free number

Connect the GATEWAY to the socket using the supplied connection cable

**Radio frequency remote actuator for BLISS2**

**Type 13.21.8.230.S000**

- 868 MHz long-range radio frequency transmission
- Multi-zone heating/cooling function
- Hygrostat function combined with the BLISS2 thermostat
- Compatible with the BLISS2 smart thermostat

13.21

Screw terminals

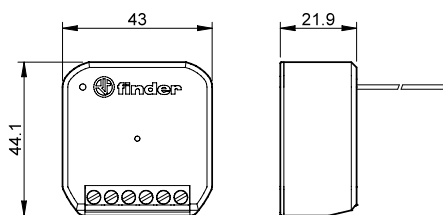

**NEW** 13.21.8.230.S000

BLISS2



- 1 CO (SPDT) 16 A 250 V AC
- Compatible with BLISS2 smart thermostat
- Heating/cooling systems - direct or solenoid control
- It can be used in dehumidification or forced ventilation systems

**Contact specification**

Contact configuration		1 CO (SPDT)
Rated current	A	16
Rated voltage/ Maximum switching voltage	V AC	250
Rated load AC1	VA	3600
Rated load AC15 (230 V AC)	VA	600
Single phase motor rating (230 V AC)	W	500
Nominal lamp rating 230V:		
incandescent/halogen W		—
fluorescent tubes with electronic ballast W		—
fluorescent tubes with electromagnetic ballast W		—
CFL W		—
LED 230 V W		—
LV halogen or LED with electronic ballast W		—
LV halogen or LED with electromagnetic ballast W		—

**Supply specification**

Nominal voltage (U <sub>N</sub> )	V AC (50/60 Hz)	110...230
	V DC	—
Rated power AC/DC	V A (50 Hz)/W	2.8 / 0.8
Operating range	AC (50 Hz)	(0.8...1.1)U <sub>N</sub>
	DC	—

**Technical data**

Electrical life at rated load in AC1	cycles	50 · 10 <sup>3</sup>
Maximum impulse duration		—
Dielectric strength between: open contacts	V AC	1000
Ambient temperature range	°C	-10...+50
Protection category		IP 20

**Approvals** (according to type)



### Ordering information

Example: radio frequency remote actuator.

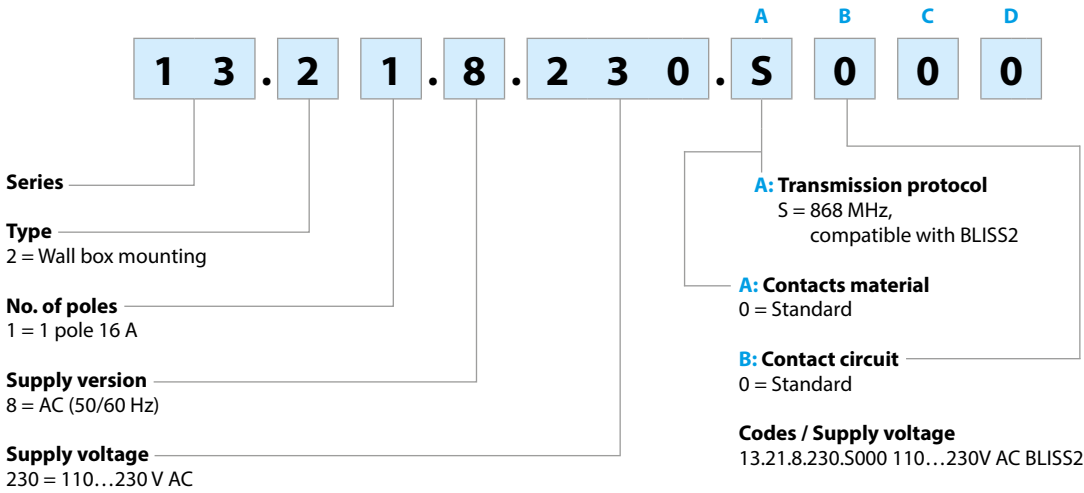

### Wiring diagrams

#### Type 13.21.8.230.S000

Solenoid valve with 2, 3 and 4 wires or direct connection

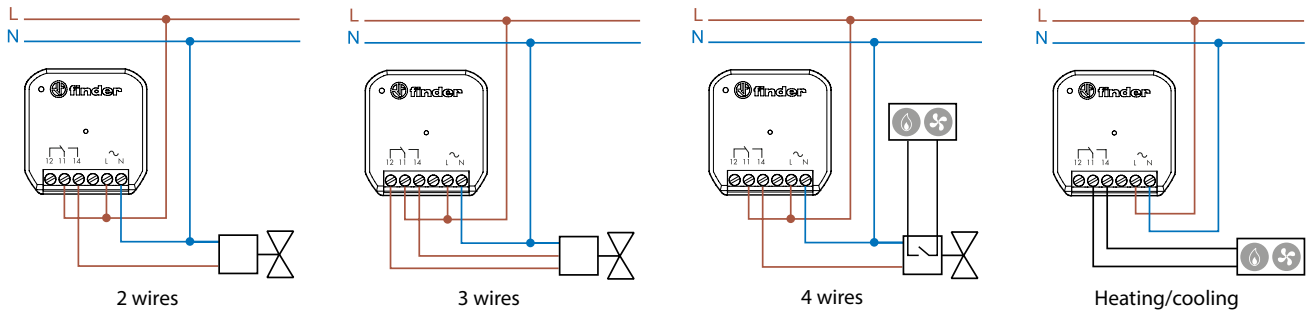

Example of connection with a 230 V AC solenoid valve, always refer to the technical characteristics of the solenoid valve.

### Accessories



013.17

Adapter for DIN rail, to install devices 13.21 in the electrical panel.

013.17

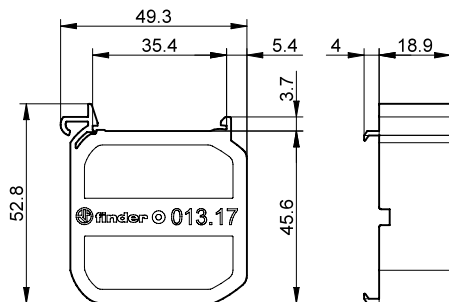



**Wi-Fi Chronothermostat**

- Remote management via the app (Android or iOS)
- Manual, or guided app programming
- Stunning design
- Touch keys
- 4 batteries 1.5 V AA
- Summer/winter function
- PIN lock padlock function
- Setting 5...37°C
- Contact rating 5 A 250 V AC

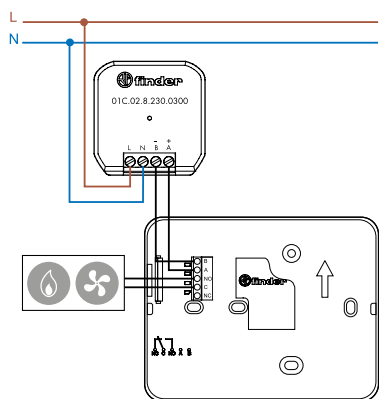

Wiring diagram

1C.91 BLISS<sup>Wi-Fi</sup>

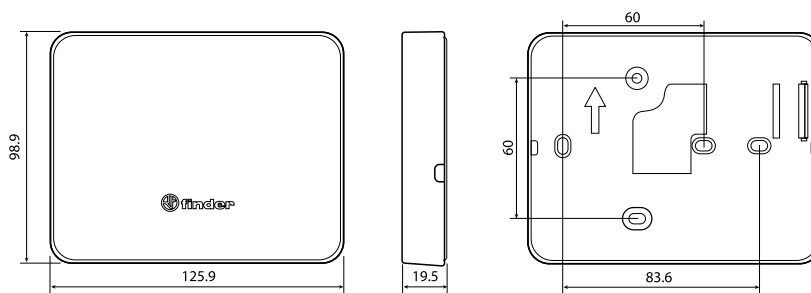

Colour	Weekly Chronothermostat
White	1C.91.9.003.0W07
Technical features	
Sensing element	NTC
Supply	4 batteries 1.5 V AA
Contact configuration	1 CO (SPDT)
Contact rating	5 A/250 V AC
Display range	0...+50 °C
Temperature setting range	+5...+37 °C
Temperature differential	0.2 °C self-adjusting / settable by app
Temperature rate of change	—
Nighttime set-back	—
Independently set temperature levels	from 5...37 °C
Thermostat lock	3 digit PIN
Protection category	IP 20
Mounting	Surface
Temperature resolution	0.1 °C
Accuracy at +20 °C	+/-0.5 °C
Frost Protection	+5 °C
Weekly/Daily	Weekly
Minimum programming interval	1 hour
Energy saving function	Geolocation
Push buttons	Touch keys
Supervisory control	NO
Back-light display	YES
Communications	Wi-Fi
App programming	YES
<b>Approvals</b> (according to type)	<b>CE UK EAC ENEC</b>

## Programming mode with Wi-Fi

### Remote control

The Finder YOU app allows you to manage your BLISS Wi-Fi chronothermostat wherever you are.

Connecting your BLISS Wi-Fi to the home network you can:

- decide to change the set temperature at any time
- activate the **AUTOAWAY** function to save energy automatically when you leave home
- create your favorite weekly or daily programs
- manage all your chronothermostats in your home or in different homes
- share your **BLISS** settings with other users

### New app for quick and easy programming



AVAILABLE ON



### Touch keys

#### Turn on the display using the "Finder" button



#### Adjustment



### Statistics and Reporting

Manage the consumption history over a selected period. Optimize the heating by monitoring the boiler switch-on times for greater energy savings.

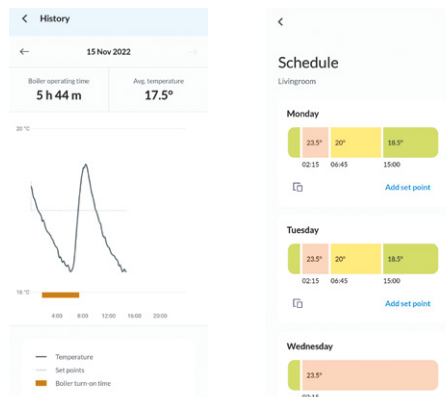

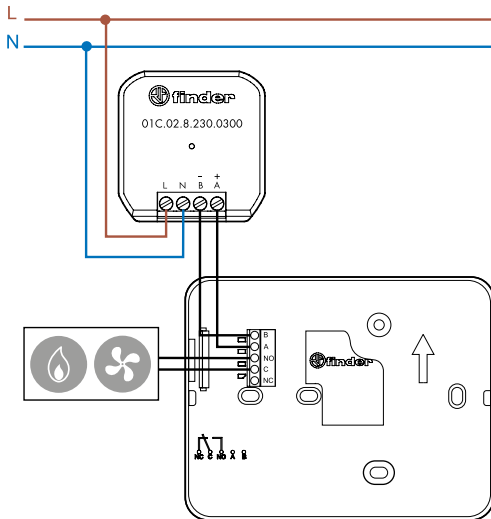

### Type 01C.02.8.230.0300 Power supply for chronothermostat BLISS Wi-Fi

- Rated power: 2 W
- Nominal voltage: 110...230 V AC
- Output voltage: 3.3 V DC
- Ambient temperature range: 0...40 °C
- Maximum cable length between power supply and chronothermostat BLISS Wi-Fi: 10 m (2x1.5 mm<sup>2</sup> flexible cable)

When using the chronothermostat with the external power supply, the batteries **MUST** be removed.

Within the application, in the "Update time" section, Level 4 (fast connection) can be set.

**Digital touch basic room chronothermostat**

- Touch display with guided programming
- Ultra-compact design
- 3 programmable temperature levels
- Functions: party program, recalibration of displayed temperature, manual timed with calendar setting, frost protection, pump anti-seizure and calibration functions
- Summer/Winter switch
- Simple touch screen blocking or full 3-digit PIN lock
- Calendar with automatic leap year & daylight-saving updates
- Partial display block or full lock with PIN code
- Multi-function and multi-touch buttons
- Surface mounting over 3 module wall box (eg. type 503)

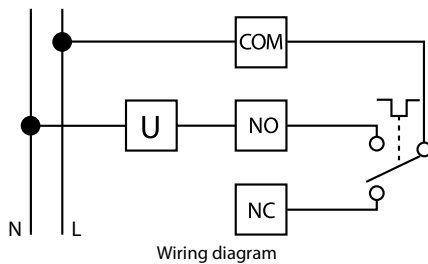
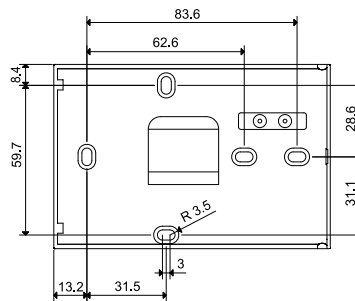
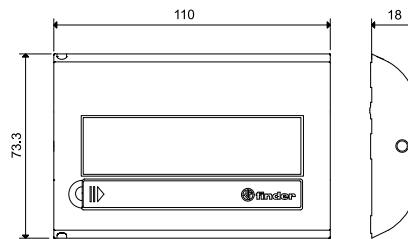
**1C.71**

Colour	Weekly Program
White	1C.71.9.003.0007
Technical features	
Sensing element	NTC
Supply	2 batteries 1.5 V AAA
Contact configuration	1 CO (SPDT)
Contact rating	5 A/250 V AC
Display range	0...+50 °C
Temperature setting range	+5...+37 °C
Temperature differential	0.1...0.9 °C
Temperature rate of change	—
Nighttime set-back	—
Independently set temperature levels	3
Thermostat lock	Basic or 3 digit PIN
Protection category	IP 20
Mounting	Surface
Temperature resolution	0.1 °C
Accuracy at +20 °C	+/-0.5 °C
Frost Protection	+2...+8 °C
Weekly/Daily	Weekly
Minimum programming interval	1 hour
Energy saving function	—
Push buttons	Touch screen
Supervisory control	NO
Back-light display	NO
Communications	—
App programming	—
<b>Approvals</b> (according to type)	

**Digital "touch slide" chronothermostat**

- Touch display with guided programming
- Chronothermostat "touch slide" ultra-thin 17 mm only with wide display
- Easy to use
- Summer/Winter switch
- 24 point for temperature setting
- Basic display lock or advanced with PIN, with storage of all settings
- Minimum interval setting 15 minutes
- The weekly function allows each day to be set to, automatic mode, hand mode, or OFF
- Calibration function
- Input for remote control
- Dynamic icons
- Surface mounting over 3 module wall box (eg. type 503)

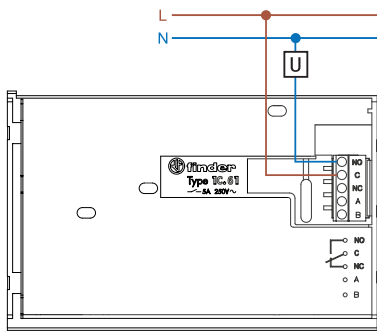

Wiring diagram

**1C.61**

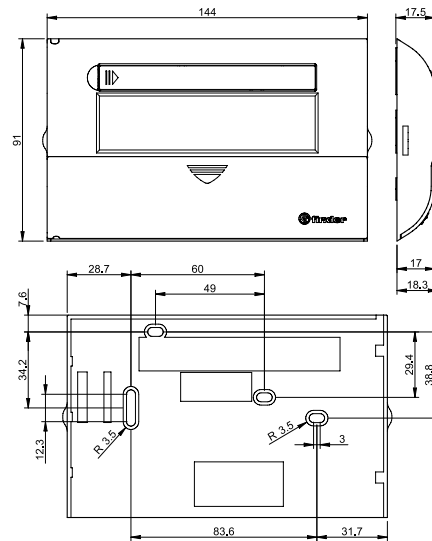

Colour	Daily Program
White RAL 9010	1C.61.9.003.0101
Technical features	
Sensing element	NTC
Supply	2 batteries 1.5 V AAA
Contact configuration	1 CO (SPDT)
Contact rating	5 A/250 V AC
Display range	0...+50 °C
Temperature setting range	+5...+37 °C (with sliders: <b>winter</b> +6...+24 °C/ <b>summer</b> +18...+30 °C)
Temperature differential	0.1...0.9 °C
Temperature rate of change	—
Nighttime set-back	—
Independently set temperature levels	Sliders
Thermostat lock	Basic or 3 digit PIN
Protection category	IP 20
Mounting	Surface
Temperature resolution	0.5 °C
Accuracy at +20 °C	+/-0.5 °C
Frost Protection	+2...+8 °C
Weekly/Daily	Daily + 7 Daily
Minimum programming interval	1 h or 15 minutes - daily/weekly (weekly: only Auto, Manual and OFF mode)
Energy saving function	—
Push buttons	Touch screen
Supervisory control	NO
Back-light display	YES
Communications	—
App programming	—
<b>Approvals</b> (according to type)	<b>CE UK EAC</b>



# YESLY Multifunction Electronic Relays



Bathroom lighting control



Bedroom light control



Living room light control



Office lighting control







**Multi and Single function electronic relays with Bluetooth**

**13.22 - Electronic multifunction relay 2 Pole**

- Round wall box (ie: Ø 60 mm) mounting
- 21 available functions (step relays, timer, staircase timer) for lighting and fan motor control

**13.72 - Electronic multifunction relay 2 Pole**

- Wall mounting, compatible with most popular Italian residential switch boxes: AVE, BTicino, Gewiss, Simon-Urmet, Vimar
- 21 available functions: step relays, timing (1s - 24h), electric shutter, blind or curtain control

**13.S2 - Electronic roller shutter actuator**

- Round wall box (ie: Ø 60 mm) mounting
- For electric shutter, blind or curtain control
- 2 contacts NO 6 A - 230 V AC independent and programmable channels
- 2 inputs for wired pushbuttons (one input per channel)
- Transmission range: approximately 10 m in free space and without obstacles

13.22/S2/72  
Screw terminals



NOTE: with 110...125 V AC supply, the Ratings (AC1, AC15 and lamp loads) must be reduced by 50 % (e.g. 200 W instead of 100 W)

For outline drawing see page 8

**Contact specification**

Contact configuration	2 NO (DPST-NO)	2 NO (DPST-NO)	2 NO (DPST-NO)
Rated current/Maximum peak current	A 6/40	6/40	6/40
Rated voltage/Maximum switching voltage	V AC 230/—	230/—	230/—
Rated load AC1	VA 1380	1380	1380
Rated load AC15 (230 V AC)	VA 300	300	300
Single phase motor rating (230 V AC)	W 200	200	200
Nominal lamp rating 230V:			
incandescent/halogen W	200	200	—
fluorescent tubes with electronic ballast W	200	200	—
fluorescent tubes with electromagnetic ballast W	200	200	—
CFL W	200	200	—
LED 230 V W	200	200	—
LV halogen or LED with electronic ballast W	200	200	—
LV halogen or LED with electromagnetic ballast W	200	200	—

**Supply specification**

Nominal voltage (U <sub>N</sub> )	V AC (50/60 Hz) 110...230	110...230	110...230
	V DC —	—	—
Rated power AC/DC	VA (50 Hz)/W 2 / 0.5	2 / 0.5	2 / 0.5
Operating range	AC (50 Hz) (0.8...1.1)U <sub>N</sub>	(0.8...1.1)U <sub>N</sub>	(0.8...1.1)U <sub>N</sub>
	DC —	—	—

**Technical data**

Electrical life at rated load in AC1	cycles 60 · 10 <sup>3</sup>	60 · 10 <sup>3</sup>	60 · 10 <sup>3</sup>
Maximum impulse duration	continuous	continuous	continuous
Dielectric strength between: open contacts	V AC 1000	1000	1000
Ambient temperature range	°C -10...+50	-10...+50	-10...+50
Protection category	IP 20	IP 20	IP 20

**Approvals** (according to type)



- Offering a variety of ON/OFF functions associated with lighting and fan motor control
- Transmission protocol Bluetooth Low Energy (BLE)
- Safe connection with 128-bit encryption
- App programming with iOS or Android Smartphone: Finder YOU
- Can be managed through standard pushbuttons, BEYON and Type 013.B9 wireless buttons

- Offering a variety of ON/OFF functions associated with lighting, electric shutters, blinds or curtains
- Transmission protocol Bluetooth Low Energy (BLE)
- Safe connection with 128-bit encryption
- App programming with iOS or Android Smartphone: Finder YOU
- Can be managed through standard pushbuttons, BEYON and Type 013.B9 wireless buttons

- Suitable for electric shutters, blind or curtain control
- Transmission protocol Bluetooth Low Energy (BLE)
- Safe connection with 128-bit encryption
- App programming with iOS or Android Smartphone: Finder YOU
- Can be managed through standard pushbuttons, BEYON and Type 013.B9 wireless buttons

**Bluetooth single channel multifunction relay** NEW **13.21.8.230.B000**
**Type 13.21.8.230.B000**

- BLE communication protocol
- Round wall box (ie: Ø 60 mm) mounting
- 12 available functions
- Up to 8 scenarios
- Pushbutton Phase or Neutral connection

YESLY



13.21

Screw terminals



- 1 CO (SPDT) 16 A 250 V AC
- Bluetooth Low Energy (BLE) transmission protocol
- 128-bit encrypted connection
- Programmable via app Finder YOU compatible with iOS and Android operating systems
- It can be connected to wired buttons or to BEYON and 013B9 wireless buttons
- Recess mounting

For outline drawing see page 9

**Contact specification**

Contact configuration		1 CO (SPDT)
Rated current	A	16
Rated voltage/ Maximum switching voltage	V AC	250
Rated load AC1	VA	3600
Rated load AC15 (230 V AC)	VA	600
Single phase motor rating (230 V AC)	W	500
Nominal lamp rating 230V:		
incandescent/halogen W		1000
fluorescent tubes with electronic ballast W		500
fluorescent tubes with electromagnetic ballast W		350
CFL W		300
LED 230 V W		200
LV halogen or LED with electronic ballast W		200
LV halogen or LED with electromagnetic ballast W		500

**Supply specification**

Nominal voltage (U <sub>N</sub> )	V AC (50/60 Hz)	110...230
	V DC	—
Rated power AC/DC	V A (50 Hz)/W	2.8 / 0.8
Operating range	AC (50 Hz)	(0.8...1.1)U <sub>N</sub>
	DC	—

**Technical data**

Electrical life at rated load in AC1	cycles	50 · 10 <sup>3</sup>
Maximum impulse duration		continuous
Dielectric strength between: open contacts	V AC	1000
Ambient temperature range	°C	-10...+50
Protection category		IP 20

**Approvals** (according to type)

## Ordering information

Example: Multifunction relay with YESLY Bluetooth.

1 3 . 7 2 . 8 . 2 3 0 . A B 0 0 0

**Series** ————

**Type** ————

2 = YESLY - multifunction relay, wall box mounting

7 = YESLY - Multifunction relay compatible with the most popular Italian wall switch systems: AVE, BTicino, Gewiss, Simon-Urmet, Vimar

S = YESLY - Shutter/blind/curtain actuator, wall box mounting

**No. of poles** ————

1 = 1 pole 16 A

2 = 2 poles 6 A NO (SPST-NO)

**Supply version** ————

8 = AC (50/60 Hz)

**Supply voltage** ————

230 = 110...230 V AC

**A: Transmission protocol**

B = Bluetooth Low Energy (BLE)

0 = White  
2 = Anthracite gray

**Codes / Supply voltage**

13.21.8.230.B000 110...230 V AC YESLY

13.22.8.230.B000 110...230 V AC YESLY

13.S2.8.230.B000 110...230 V AC YESLY

13.72.8.230.B000 110...230 V AC YESLY BLE white

13.72.8.230.B002 110...230 V AC YESLY BLE anthracite gray

## Technical data

Terminals		13.72		13.21 - 13.22 - 13.S2	
Max. wire size		solid cable	stranded cable	solid cable	stranded cable
	mm <sup>2</sup>	1 x 6 / 2 x 4	1 x 4 / 2 x 2.5	1 x 2.5 / 2 x 1.5	1 x 2.5 / 2 x 1
	AWG	1 x 10 / 2 x 12	1 x 12 / 2 x 14	1 x 14 / 2 x 16	1 x 14 / 2 x 16
Screw torque	Nm	0.8		0.5	
Wire strip length	mm	9			
Other data		13.21		13.22 - 13.S2 - 13.72	
Power lost to the environment	without contact current	W	0.4	0.5	
	with rated current	W	2.2	1.5	

## EMC specifications

Type of test	Reference standard		
Electrostatic discharge	contact discharge	EN 61000-4-2	4kV
	air discharge	EN 61000-4-2	8kV
Radiated electromagnetic field	(80...3000 MHz)	EN 61000-4-3	10 V/m
Fast transients (burst) (5-50 ns, 5 and 100 kHz)	on supply terminals	EN 61000-4-4	4kV
	on pushbutton connection	EN 61000-4-4	4kV
Voltage pulses on supply terminals (surge 1.2/50 µs)	differential mode	EN 61000-4-5	2kV
Radiofrequency common mode voltage (0.15...80 MHz)	on supply terminals	EN 61000-4-6	10 V
	on pushbutton connection	EN 61000-4-6	10 V
Voltage dips	70% U <sub>N</sub> , 40% U <sub>N</sub>	EN 61000-4-11	10 cycles
Short interruptions		EN 61000-4-11	10 cycles
Radio frequency conducted emissions	0.15...30 MHz	EN 55015 / ETSI EN 301489-1/301489-17	Class B
Radiated emissions	30...6000 MHz	ETSI EN 301489-1/301489-17	Class B

## Functions

### Relay settings

Multifunction electronic relays can be configured with the Finder YOU app, available for iOS or Android systems. This product is ready-to-use preset with the factory setting (RI) Step relay on both channels.

Type	Functions	
13.21-B000 13.22 13.72		<p><b>(RM) Monostable relay.</b> On closure of the switch the output will close, and remain so, until the switch opens.</p>
		<p><b>(RI) Step relay (pushbutton control).</b> After every impulse, the output contact changes state - alternately switching from open to closed and vice versa.</p>
		<p><b>(RIa) Step relay - lighting switch control (Type 13.22 and 13.21.8.230.B000 only).</b> Each time a lighting switch is activated, the output contact changes state. The output state can also be changed using YESLY wireless pushbutton, a smartphone, or voice assistants. Ideal for converting a traditional lighting system using one, two, or four way switches, into a Smart system. (See page 9).</p>
		<p><b>(LE) Asymmetric flasher (starting pulse on) with control signal.</b> Power is permanently applied to the relay. Closing Signal Switch (S) causes the output contacts to transfer immediately and cycle between ON (T1) and OFF (T2), until opened.</p>
		<p><b>(DE) Interval with control signal on.</b> Power is permanently applied to the relay. On momentary or maintained closure of Signal Switch (S), the output contacts transfer, and remain so for the duration of the preset delay, after which they reset.</p>
		<p><b>(BE) Staircase timer.</b> On initial impulse the output contact closes and timing starts for the pre-set duration; subsequent impulses during the timing period will extend the timing period by the full pre-set value. On expiry of the time delay, the output contact opens.</p>
		<p><b>(ME) Staircase timer + Staircase maintenance.</b> In addition to the Staircase timer function (BE), an impulse of <math>\geq 5</math> seconds will close the output contact for 60 minutes, after which time the contact will open. Ideal for maintenance or cleaning activities. The 60 minute timing can be interrupted by a further impulse of <math>\geq 5</math> seconds, when the output contact then opens.</p>
		<p><b>(BP) Staircase timer with switch off early warning.</b> On initial impulse the output contact closes and the timing starts for the pre-set duration. After the timing period, the output contact blinks off once; 10 seconds later the contact blinks off twice, and after a further 10 seconds the contact opens. During the pre-set and 20 second warning time, it is possible, by a further impulse, to extend the time by the full pre-set value.</p>
		<p><b>(MP) Staircase timer with switch off early warning + staircase maintenance.</b> In addition to the Staircase timer function (BP), an impulse of <math>\geq 5</math> seconds will close the output contact for 60 minutes, after which time the output contact blinks off once; 10 seconds later the contact blinks off twice, and after a further 10 seconds the contact will open. Ideal for maintenance or cleaning activities. The 60 minute timing can be interrupted by a further impulse of <math>\geq 5</math> seconds, when the output contact then opens.</p>

## Functions

Type	Functions	
13.21-B000 13.22 13.72		<p><b>(IT) Timing step relay.</b> On initial impulse the output contact closes and timing starts. On expiry of the time delay, the output contact opens. During the timing period it is possible to immediately open the contact with a further impulse.</p>
		<p><b>(IP) Timing step relay with switch off early warning.</b> On initial impulse the output contact closes and timing starts. After the timing period, the output contact blinks off once; 10 seconds later the contact blinks off twice, and after a further 10 seconds the contact opens. During the pre-set and 20 second warning time, it is possible to immediately open the output contact by a further impulse.</p>
		<p><b>(FZ) Timing monostable.</b> The output will be closed when the switch is closed, except where the switch is closed for greater than the preset time T1 - in which case the output contact opens.</p>
13.22 13.72		<p><b>(VB) Bathroom light + fan.</b> Channels Ch1 and Ch2 both close when the P1 command is pressed. At the expiry of T1 Ch1 opens and after a further delay of T2, Ch2 opens. Ch1 can be prematurely opened by another press of P1.</p>
		<p><b>(CP) Ringbell + light.</b> A press to P1 closes Ch1 for the pre-set time T1. While Ch1 is closed Ch2 executes a blinking function, at a rate set by T2. Subsequent presses to P1 extends the Ch1 closed time by re-triggering T1.</p>
13.S2 13.72		<p><b>(TP) Roller shutter.</b> A short press (&lt;1 second) to P1 ("up" pushbutton) initiates a 500ms delay before Ch1 closes for time T1. Pressing P1 again within time period T1 will immediately open Ch1 contact. If P1 is closed for more than 1 second the Ch1 contact will open immediately P1 opens. The same operation applies to P2 and Ch2 contact, used to control the "down" function.</p>

## Sequences

**P1 (SET):** press to advance through the sequence

**P2 (RESET):** press to return to Step 1

Type	Functions	Sequences			
		1	2	3	4
13.22 13.72	02				
	03				
	04				
	05				
	06				
	07				
	08				

Wiring diagrams

**Type 13.21.8.230.B000**

Wiring with pushbutton to phase

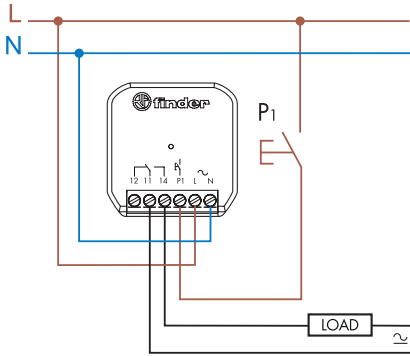

**Type 13.21.8.230.B000**

Wiring with pushbutton to neutral

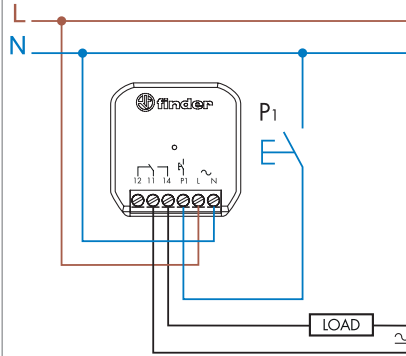

**Note:** If the load is powered by a phase other than the one that powers the 13.21, a 50% reduction in the lamp capacity must be considered (set the "Different phase" function from the Finder YOU app).

**Type 13.22**

4 wire connection

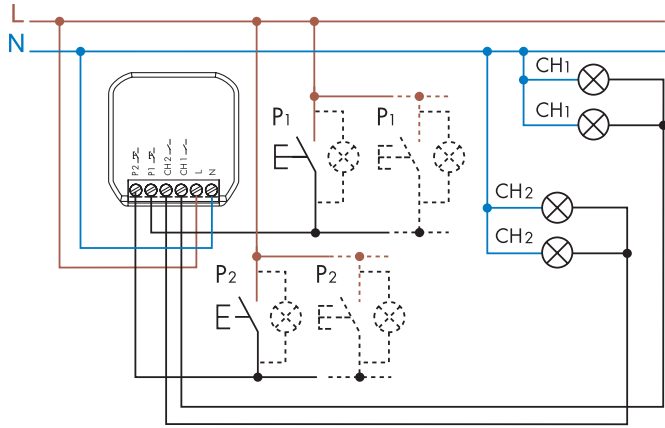

Maximum 5 ( $\leq 1$  mA)  
illuminated push buttons

**Type 13.52**

4 wire connection

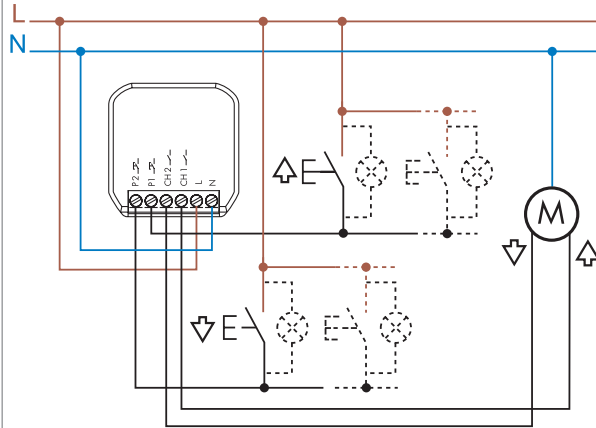

Maximum 5 ( $\leq 1$  mA)  
illuminated push buttons

**Type 13.72**

4 wire connection

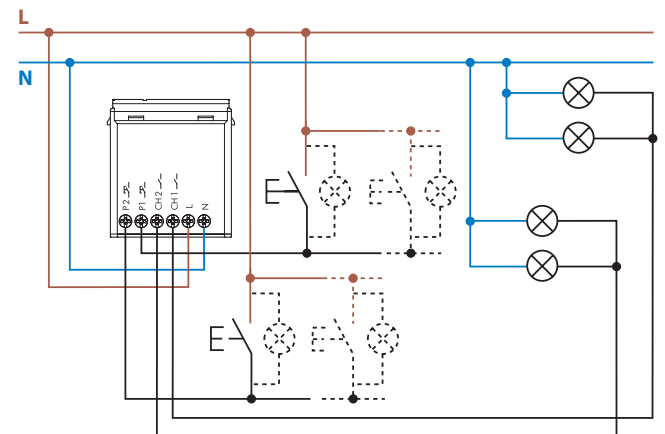

Maximum 5 ( $\leq 1$  mA)  
illuminated push buttons

## Outline drawings

Type 13.72  
Screw terminal

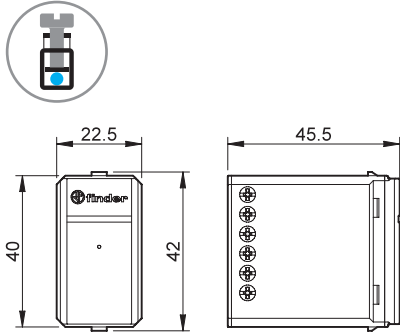

Types 13.21 / 13.22 / 13.S2  
Screw terminal

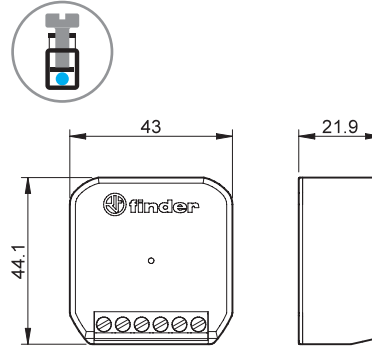

## Examples of applications

### Function TP - Roller Blinds, Shutters and Curtains

Type 13.72

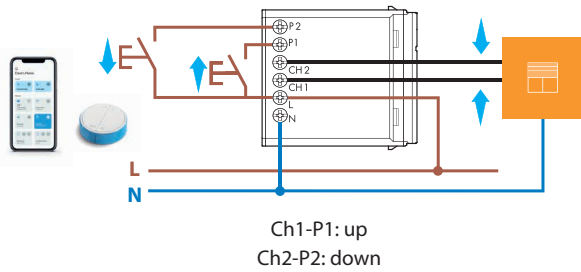

Type 13.S2

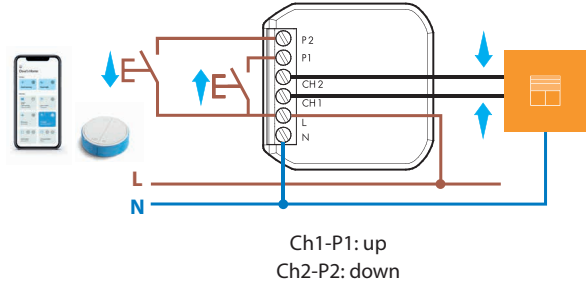

### Function VB - Bathroom light + fan

Type 13.72

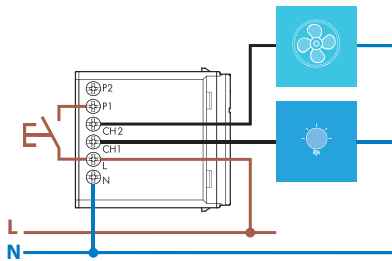

Type 13.22

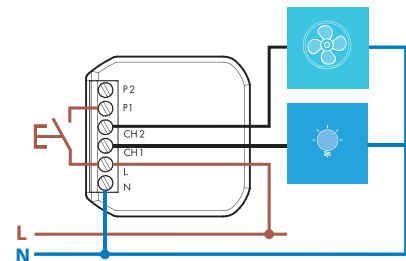

### Function CP - Ringbell + Lights

Type 13.72

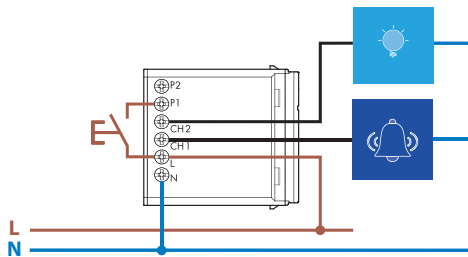

Type 13.22

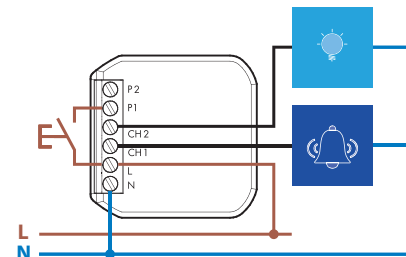

Examples of applications

**Type 13.21.8.230.B000 - Special function R1a - Step relay (switch control).**

**Ideal for converting a traditional lighting system using one, two, or four way switches, into a Smart system.  
Any existing system can be made Smart with minimum change or disruption**

*The smart system can be controlled by: wireless buttons, smartphone and gateway*

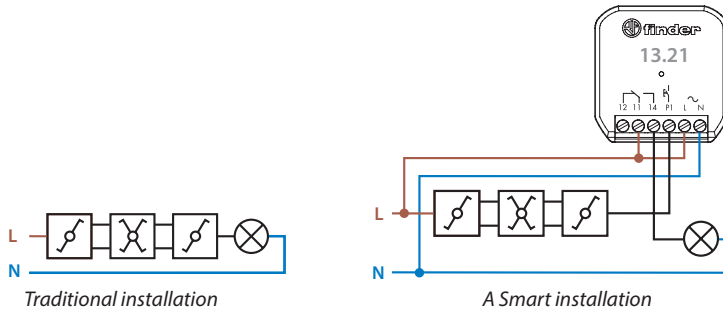

**Type 13.22 - Special function R1a - Step relay (switch control).**

**Ideal for converting a traditional lighting system using one, two, or four way switches, into a Smart system.**

*The Smart system controls with just a momentary push to a wired, YESLY wireless or Smartphone pushbutton*

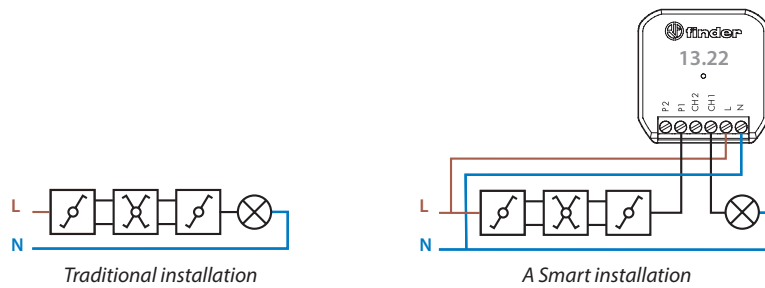



## Accessories

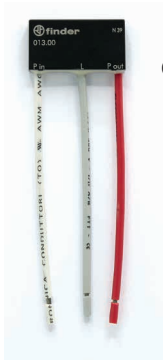

013.00

**Pushbutton phase/neutral converter.** Use this with a pre-existing neutral wired pushbutton when retro fitting a device designed only for phase connected pushbuttons. This avoids any radical change to the existing wiring.

013.00

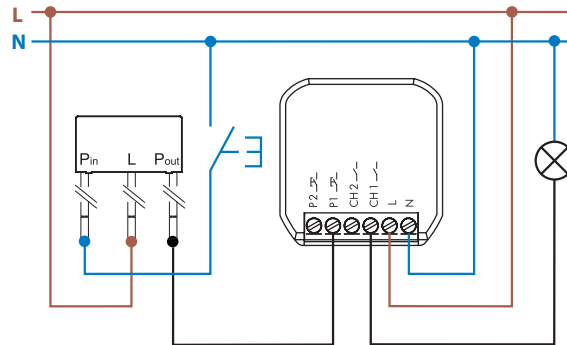

Application example with type 13.22



013.17

**Adapter for DIN rail,** to install devices 13.22, 13.21, 13.52 in the electrical panel.

013.17

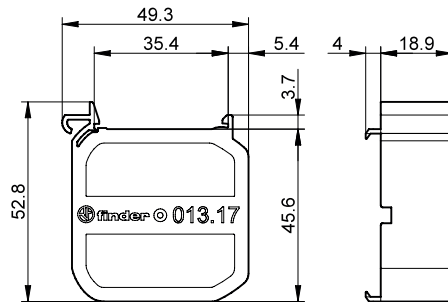



# YESLY Dimmers



Kitchen  
light control



Bedroom  
light control



Living room  
light control





**YESLY Bluetooth Dimmers**

**Type 15.21.8.230.B300**

- Round wall box (ie: Ø 60mm) mounting

**Type 15.71**

- Wall mounting, compatible with most common Italian residential switch boxes: AVE, BTicino, Gewiss, Simon-Urmet, Vimar

- 7 functions, dependent on the load type
- Functions with or without memory
- Dimming operating mode Trailing edge or Leading edge
- Linear/exponential regulation
- Suitable for dimmable LED lamps, dimmable CFL lamps, halogen lamps, transformers or electronic power supplies
- Transmission range: approximately 10 m in free space and without obstacles
- "Soft" switching ON/OFF
- Over-temperature and short-circuit protection

Screw terminal



For outline drawing see page 7

<b>Output data</b>			
Rated voltage	V AC	230	230
Power max.	W	300	200
Power min.	W	3	3
Nominal lamp ratings:			
230 V incandescent or halogen W		300	200
Toroidal electromagnetic transformers for LV halogen W		300	200
E-core electromagnetic transformers for LV halogen W		300	200
Electronic transformers (or ballasts) for LV halogen W		300	200
Dimmable compact fluorescent (CFL) W		150	100
230 V Dimmable LED Lamp W		150	100
230 V LED Strip W		270 <sup>(1)</sup>	180 <sup>(1)</sup>
Dimmable electronic transformers for LV LED W		300	200
<b>Supply specification</b>			
Nominal voltage (U <sub>N</sub> )	V AC	230	230
Operating range		(0.8...1.1) U <sub>N</sub>	(0.8...1.1) U <sub>N</sub>
Stand-by power consumption	W	0.4	0.4
<b>Technical data</b>			
Dimming operating mode		Trailing edge / Leading edge	Trailing edge / Leading edge
Ambient temperature range	°C	-10...+50	-10...+50
Protection category		IP 20	IP 20
<b>Approvals (according to type)</b>			

**NEW 15.21.8.230.B300**

YESLY



- Transmission protocol Bluetooth Low Energy (BLE)
- 128 bit encrypted connection
- Configurable via Finder YOU app - compatible with iOS and Android operating systems
- Can be controlled through standard pushbuttons, BEYON or 013.B9 wireless pushbuttons
- Maximum dimmable power 300 W
- Status LED

**NEW 15.71**

YESLY



- Transmission protocol Bluetooth Low Energy (BLE)
- 128 bit encrypted connection
- Configurable via Finder YOU app - compatible with iOS and Android operating systems
- Can be controlled through standard pushbuttons, BEYON or 013.B9 wireless pushbuttons
- Maximum dimmable power 200 W
- Status LED

**Note** <sup>(1)</sup> Select "Trailing edge" dimming operating mode from the application.

**PWM Dimmer for LED strip Bluetooth YESLY****Type 15.21.9.024.B200**

- Round wall box (ie: Ø 60mm) mounting
- LED strip
- "Soft" switching ON/OFF
- Protected against short-circuit, overload and reverse polarity
- Three PWM operating frequencies (selectable) - to counter "strobe" effect with camera

Screw terminal

**NEW 15.21.9.024.B200**

YESLY



- Transmission protocol Bluetooth Low Energy (BLE)
- 128 bit encrypted connection
- Configurable via Finder YOU app - compatible with iOS and Android operating systems
- Can be controlled through standard pushbuttons, BEYON or 013.B9 wireless pushbuttons
- Maximum dimmable power 192 W
- Three PWM operating frequencies (selectable) - to counter "strobe" effect with camera

For outline drawing see page 7

Output data		
Rated voltage	V DC	12...24
Maximum current	A	8
LED strip:		
	24 V W	192
	12 V W	96
Supply specification		
Nominal voltage (U <sub>N</sub> )	V DC	12...24
Operating range		—
Stand-by power consumption	W	—
Technical data		
Dimming operating mode		PWM
Ambient temperature range	°C	-10...+50
Protection category		IP 20
<b>Approvals</b> (according to type)		<b>CE UK EAC</b>

## Ordering information

Example: type 15.71, YESLY Bluetooth dimmer, 230 V AC.

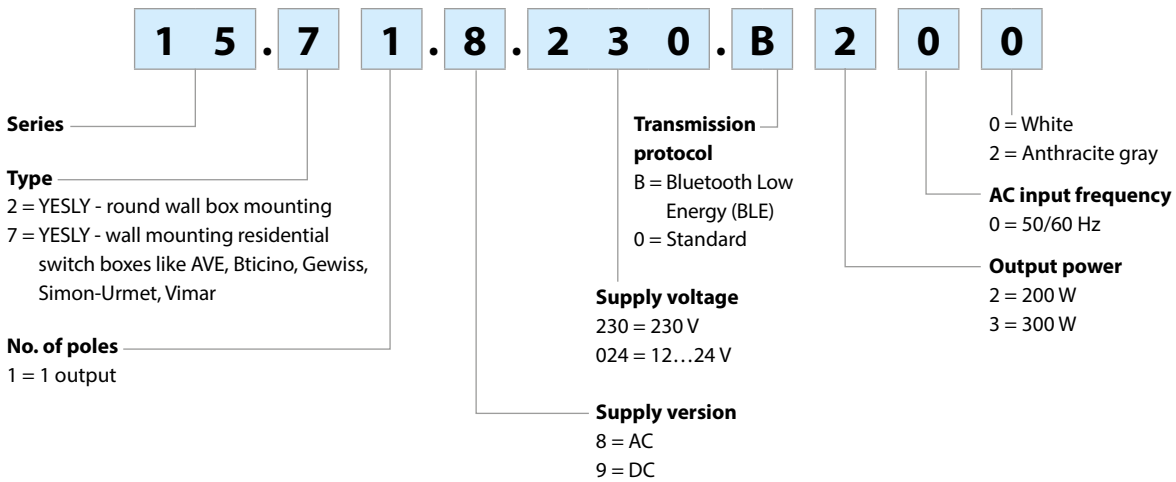

### Available Codes

- 15.21.8.230.B300 YESLY BLE Dimmer - 300 W, White
- 15.21.9.024.B200 YESLY BLE Dimmer PWM
- 15.71.8.230.B200 YESLY BLE Dimmer - 200 W, White
- 15.71.8.230.B202 YESLY BLE Dimmer - 200 W, Anthracite

## Technical data

EMC specifications					
Type of test		Reference standard	15.21.8.230.B300/ 15.71	15.21.9.024.B200	
Electrostatic discharge	contact discharge	EN 61000-4-2	4kV	4kV	
	air discharge	EN 61000-4-2	8kV	8kV	
Radiated electromagnetic field	(80...3000 MHz)	EN 61000-4-3	10 V/m	10 V/m	
Fast transients (burst) (5-50 ns, 5 and 100 kHz)	on supply terminals	EN 61000-4-4	2kV	2kV	
	on pushbutton connection	EN 61000-4-4	4kV	1kV	
Voltage pulses on supply terminals (surge 1.2/50 µs)	differential mode	EN 61000-4-5	2kV	1kV	
Radiofrequency common mode voltage (0.15...80 MHz)	on supply terminals	EN 61000-4-6	10 V	10 V	
	on pushbutton connection	EN 61000-4-6	10 V	10 V	
Voltage dips	70% U <sub>N</sub> , 40% U <sub>N</sub>	EN 61000-4-11	10 cycles	10 cycles	
Short interruptions		EN 61000-4-11	10 cycles	10 cycles	
Radiofrequency conducted emissions	0.15...30 MHz	EN 55015 / ETSI EN 301489-1/301489-17	class B	class B	
Radiated emissions	30...6000 MHz	EN 55015 / ETSI EN 301489-1/301489-17	class B	class B	
Terminals		15.71		15.21	
Max. wire size		solid cable	stranded cable	solid cable	stranded cable
	mm <sup>2</sup>	1 x 6 / 2 x 4	1 x 4 / 2 x 2.5	1 x 2.5 / 2 x 1.5	1 x 2.5 / 2 x 1
	AWG	1 x 10 / 2 x 12	1 x 12 / 2 x 14	1 x 14 / 2 x 16	1 x 14 / 2 x 16
Screw torque	Nm	0.8		0.5	
Wire strip length	mm	9			
Other data		15.71		15.21	
Power lost to the environment	without load	W	0.4		0.4
	with rated load	W	2		2.5

## Dimming method

### PWM:

"Pulse Width Modulation" regulates electrical power by modulating the width of the ON time relative to the OFF time. The higher the duty cycle, the greater the power applied to the load. PWM is exclusively for direct current and is used particularly for the dimming of DC LED strips. In this case, the dimmer is positioned downstream of the power supply.

#### Duty Cycle 10 %

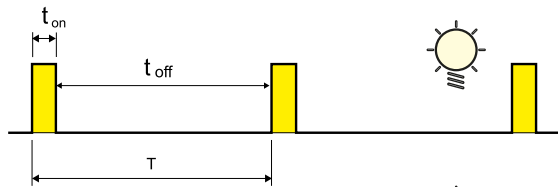

#### Duty Cycle 90 %

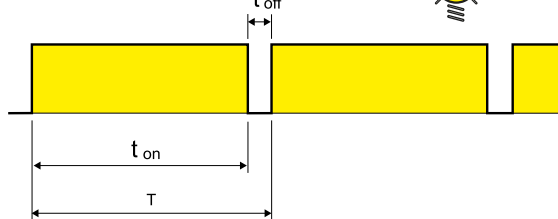







## Dimmer setting - Types 15.21 and 15.71

The dimming function can be set via Finder YOU app, available for iOS and Android systems.

This product is ready-to-use with the factory setting: 1 – LEDRC1; Trailing edge linear control curve.

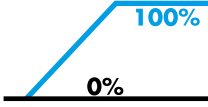
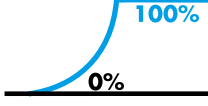
## Functions

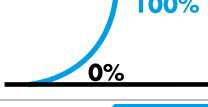
Settable via app.

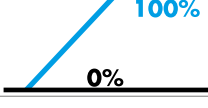
Load type	Function	Driving method	Control curve
LED lamps, Halogen, electronic transformers <b>LED</b>  	1	TE Trailing Edge	Linear 
	2	LE Leading Edge	
<b>LED</b> LED	3	TE Trailing Edge	Exponential 
	4	LE Leading Edge	
CFL lamps 	5	TE Trailing Edge	Exponential 
	6	LE Leading Edge	
Electromechanical transformers 	7	LE Leading Edge	Linear 
		<b>AUTO</b>	

**AUTO:** the automatic function verifies with a special algorithm the driving method (Trailing edge or Leading edge) best suited to the applied load. If the AUTO function is selected, the dimmer carries out a check switching on the load with two working cycles each time the dimmer is powered from the L & N (even after a blackout). These cycles allow the dimmer to set the right driving method.

**Control curve:** the Linear or Exponential control curve is useful in achieving the most visually appealing change in light intensity - according to the type of load being used.

## Parameters

Settable via Finder YOU app.

**Minimum light value:** Minimum value of load intensity.

**Switch time:** Switching ON/OFF time.

**Regulation time:** Time to reach the highest or lower light value.

**Scene time:** Reaching the value recalled by a scenario.

**Memory:** Remembers the brightness value before power off.

**Restore after blackout:** Restoring the light intensity to the value prior to a loss of power.



## Wiring diagrams

**Note:** remember to maintain a ground/earth connection for class 1 light fittings.

**Type 15.21.8.230.xxxx** - 4 wire connection

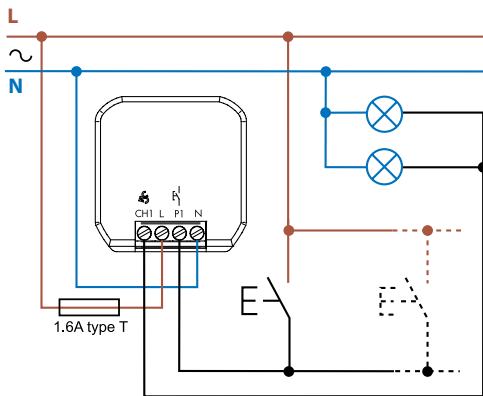

**Type 15.21.9.024.B200**

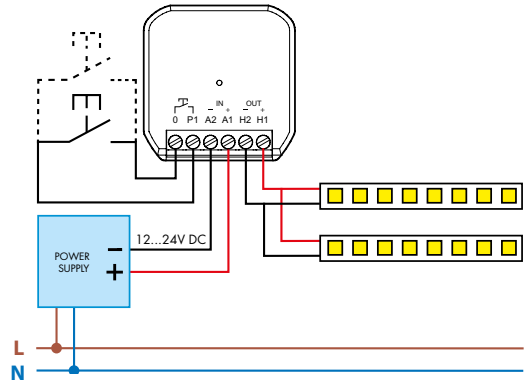

**Type 15.71** - 4 wire connection

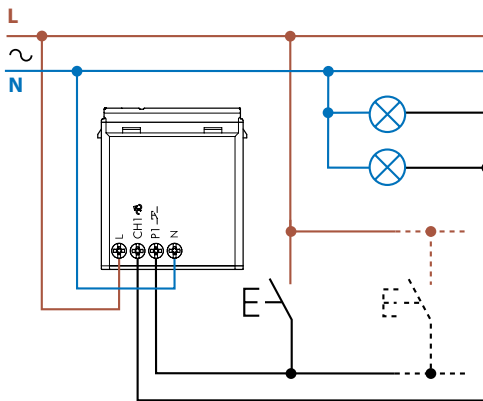

## Outline drawings

Type 15.21 - YESLY  
Screw terminal

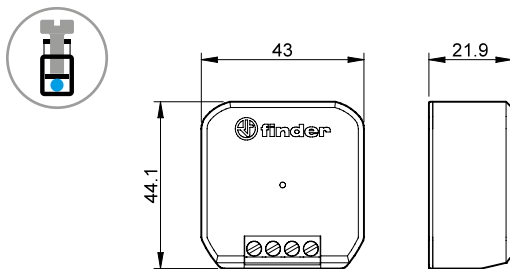

Type 15.71 - YESLY  
Screw terminal

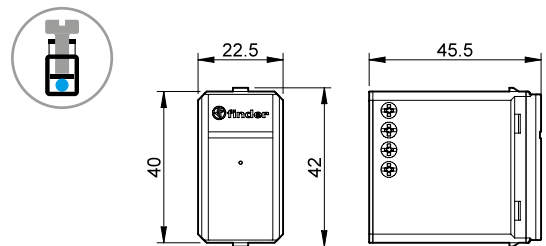

Accessories



015.0.230

**Leakage current suppression module.**

It absorbs the leakage current on the LED lamps, when, with the Dimmer off, the lamps do not turn off completely but remain on at minimum. It absorbs 0.8 W at 230 V AC.

015.0.230

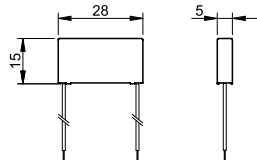

**Connection example - Type 15.21**

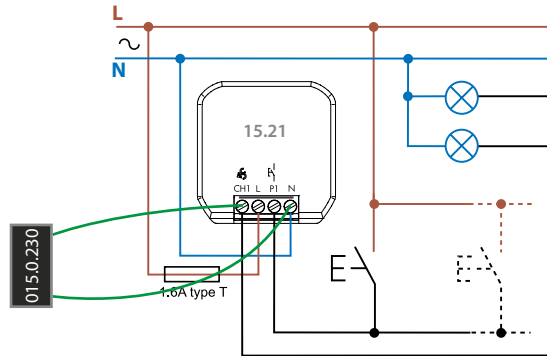

013.00

**Pushbutton phase/neutral converter.** Use this with a pre-existing neutral wired pushbutton when retro fitting a device designed only for phase connected pushbuttons. This avoids any radical change to the existing wiring.

013.00

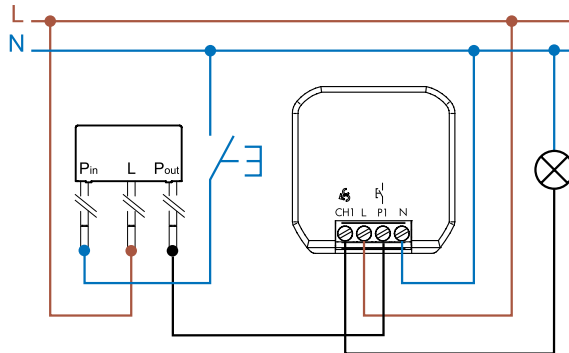

013.17

**Adapter for DIN rail,** to install devices 15.21 in the electrical panel.

013.17

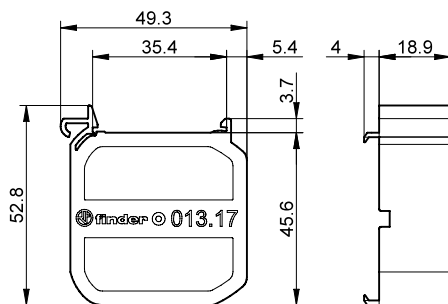

# YESLY Accessories





**Second Generation GATEWAY**

With Finder YESLY GATEWAY you can control your YESLY and the Smart BLISS2 Thermostat system remotely, wherever you are in the world. It is always possible, any time and anywhere, to check their status and make changes if necessary.

Moreover, through GATEWAY and cloud connectivity it is even possible to manage your system through voice commands using the GOOGLE Assistant or AMAZON ALEXA.

GATEWAY connects via the 2.4GHz Wi-Fi network of your home computer and communicates with YESLY and BLISS2 devices via Bluetooth or 868MHz RF transmissions.

In a situation where the Internet connection is lost the YESLY and BLISS2 devices installed in the system will continue to work as they are connected via Bluetooth or 868MHz RF transmissions to the GATEWAY.

**1Y.GU.005.1 GATEWAY**

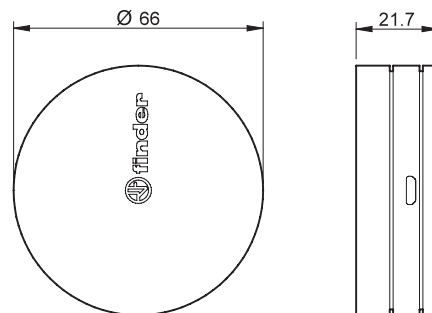

**Type**

2nd Generation GATEWAY for YESLY devices and Smart BLISS2 thermostat

**1Y.GU.005.1**

**Technical data**

Power source

5 V – 1 A min

Operating frequency

Wi-Fi 2.4 GHz / Bluetooth / 868MHz

Ambient temperature range

°C

-10...+50

Transmission range Bluetooth between YESLY devices and GATEWAY

Approximately 10 m in free space and without obstacles.  
The transmission range may vary depending on the building structure.

Transmission range 868 MHz between BLISS2 thermostat and GATEWAY

Approximately 30 m in free space.  
The transmission range may vary depending on the building structure.

**Approvals** (according to type)



**BEYON - Wireless pushbutton**

Finder's BEYON is an innovative remote control for your YESLY comfort living system.

- The clean design of the BEYON blends well with all styles of furnishings with a result that is discreet and elegant.
- BEYON can be paired, via the Finder YOU app, with other YESLY devices such as actuators and dimmers to turn on/off or dim lighting, or to control electric shutters and blinds.
- BEYON can also be configured to activate SCENARIOS as well as control many other devices of your choosing.
- Your BEYON works without batteries and without any need for recharging.
- Available with two or four channels.

**1Y.13.Bxx**

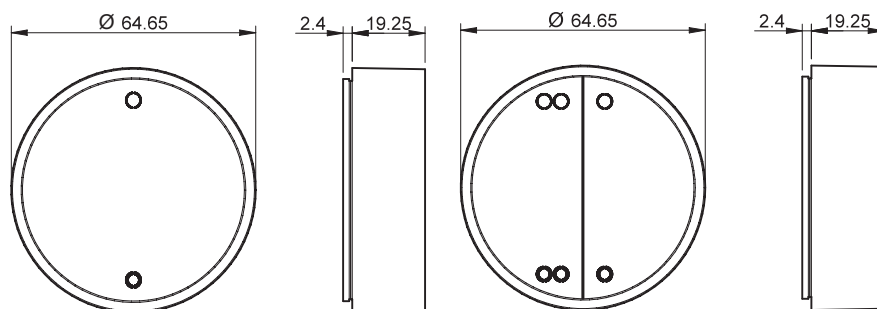

Types	
BEYON – Wireless pushbutton, 2 channels, white	<b>1Y.13.B10</b>
BEYON – Wireless pushbutton, 2 channels, black	<b>1Y.13.B12</b>
BEYON – Wireless pushbutton, 4 channels, white	<b>1Y.13.B20</b>
BEYON – Wireless pushbuttons, 4 channels, black	<b>1Y.13.B22</b>
Technical data	
Power source	Integral self powered generator
Operating frequency	2.4 GHz Bluetooth BLE
Operating cycles	cycles 50 000
Ambient temperature range	°C -25...+65
Transmission range	Approximately 10 m in free space and without obstacles. The transmission range may vary depending on the building structure.
Color	White - Black
Dimensions	mm 64.6 Ø x 24.6
<b>Approvals</b> (according to type)	<b>CE UK CA FCC IC EAC</b>

**BEYON** pushbuttons are supplied with a magnetic disc and an adhesive pad, so it is possible to attach them to most surfaces: metal, wood, glass - so you can always have it right where you need it. The silicone covers protect the BEYON from falls and provide an incredibly simple color coding, in order to associate buttons to rooms or functions.

**BEYON** is available in WHITE or BLACK , whereas cover colours are FINDER BLUE, NIGHT GREY and GLACIER WHITE.



**Wall-mounting pushbutton 013.B9**

013.B9 wireless pushbutton is an innovative remote control for your YESLY comfort living system.

- The pushbutton can be paired, via the Finder YOU app, with other YESLY devices such as actuators and dimmers to turn on/off or dim lighting, or to control electric shutters and blinds.
- The pushbutton can also be configured to activate SCENARIOS as well as control many other devices of your choosing.
- The device works without batteries and without any need for recharging.
- Configurable as two or four channels.
- The design is more classical and essential endowing the YESLY system with a more complete stylistic range.

**013.B9**



**Type**

013.B9 pushbutton can be set in 2 or 4 channel mode.

**013.B9**

**Technical data**

Source of energy	Integral self powered generator
Operating frequency	2.4 GHz Bluetooth BLE
Operating cycles	cycles 50 000
Ambient temperature range	°C -25...+65
Transmission range	Approximately 10 m in free space and without obstacles. The transmission range may vary depending on the building structure.
Color	White
Dimensions	mm 82 x 82 x 14
<b>Approvals</b> (according to type)	<b>CE UK CA FCC IC EAC</b>

**013.B9** pushbuttons are supplied with an adhesive pad, so it is possible to attach it to most surfaces: metal, wood, glass - and therefore installation can be accomplished without any structural work.

The **013.B9** button is provided with the adapters for two or four channel configuration.

**Range extender**

The range extender extends the effective transmission range of the Wireless pushbuttons and other YESLY devices if the Smartphone cannot communicate directly because of distance.

The range extender is a plug-n-play device, and does not require configuring.

**Wiring diagram**

Type 1Y.E8.230

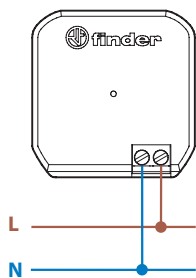

**1Y.EU.005**

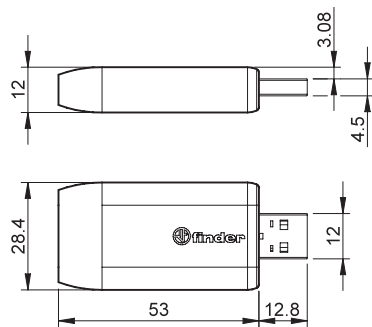

**1Y.E8.230**

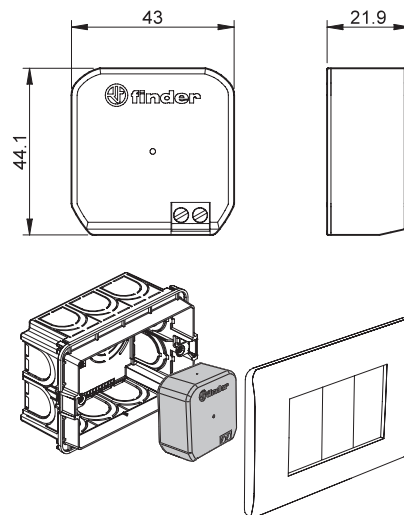

Types		
USB range extender	<b>1Y.EU.005</b>	
Range extender 110...230 V AC	<b>1Y.E8.230</b>	
Technical data		
Power supply	USB connector 5V – 0.5 A min	110...230 V AC (50/60Hz)
Operating frequency	2.4 GHz	
Ambient temperature range	°C –10...+50	
Transmission range	Approximately 10 m in free space and without obstacles. The transmission range may vary depending on the building structure.	
<b>Approvals</b> (according to type)	<b>CE UK CA FCC IC EAC</b>	

The range extenders must be installed within a maximum distance of 10 meters, and up to 4 devices can be used in the same system. It can be installed in any USB input that provides a power supply of at least 5V and 0.5A.

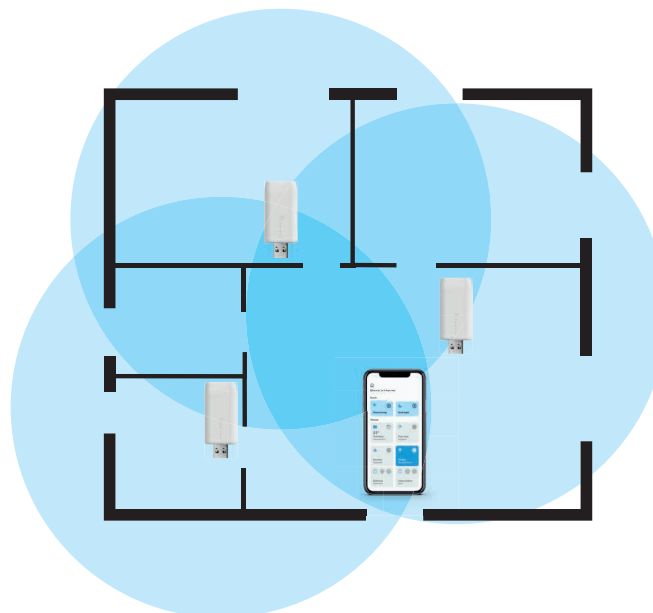
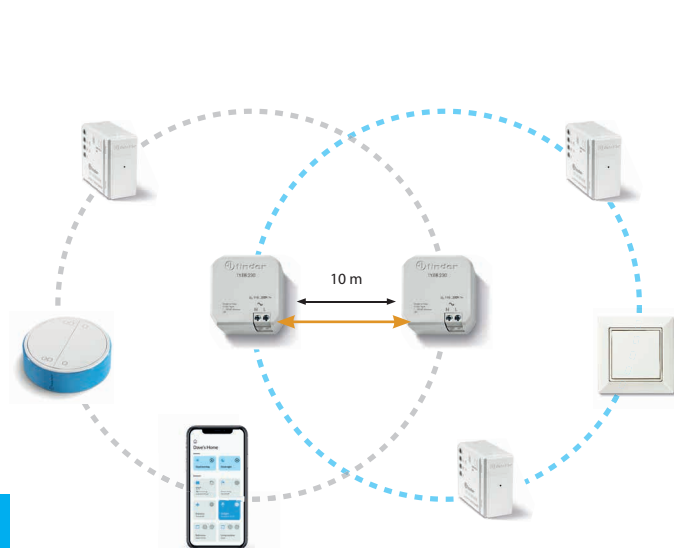



**2-Input YESLY interface unit**

The 2-input 1Y.P2 interface has been developed to accept volt-free contacts or phase voltage (L) signals as inputs, and to integrate them into a YESLY system.

It is therefore possible to control YESLY devices for lighting or roller blind control by choosing to use traditional push buttons or voltage signals.

- 2 input channels (P1 and P2)
- Suitable for controlling YESLY devices with traditional pushbuttons or switches, for example by integrating into an existing residential lighting system or with PLC outputs or relay contacts etc..
- Programming via Smartphone with Finder YOU
- Compatible with illuminated pushbuttons [max 5 ( $\leq 1$  mA) buttons]
- Transmission range: 10 meters in free space and without obstacles.

**Wiring diagram**

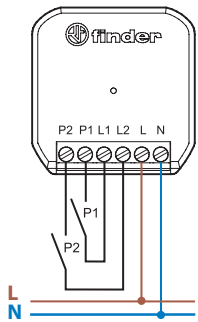

**1Y.P2.8.230.B000**

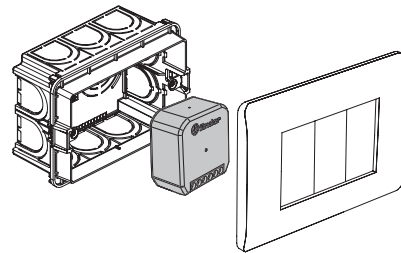
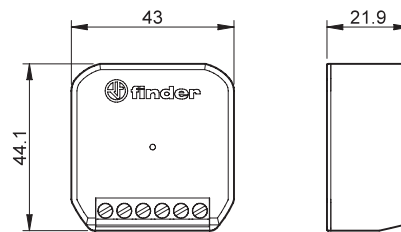

<b>Type</b>	2-Input YESLY interface unit	<b>1Y.P2.8.230.B000</b>
<b>Technical data</b>		
Power supply		110...230 V AC
Operating frequency		2.4 GHz
Ambient temperature range	°C	-10...+50
Transmission range	Approximately 10 m in free space and without obstacles. The transmission range may vary depending on the building structure.	
<b>Approvals</b> (according to type)		

Accessories

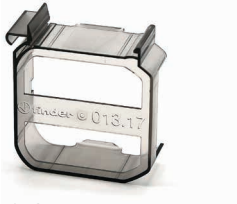

013.17

Adapter for DIN rail, to install devices 1Y.P2, 1Y.E8 in the electrical panel.

013.17

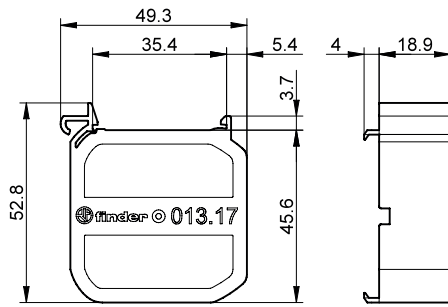

# KNX Universal Dimmer 2 channel



Kitchen  
light control



Bedroom  
light control



Living room  
light control



Lighting control  
in corridors  
(for hotels, offices  
and hospitals)



Building and  
house automation





**KNX Universal Dimmer with 2 channels**

- 2 x 400W channels
- LED indicators for each channel
- Thermal protection and short-circuit protection
- Manual override through front panel
- Scenario Management
- Power supply via KNX bus
- 35 mm rail (EN 60715) mounting
- Suitable for ETS 4 (or latest versions)

Screw terminal



**NEW** 15.2K.8.230.0400



- Dimming operating modes: Leading Edge or Trailing Edge, ETS configurable
- Suitable for many kind of loads: LED lamps, halogen, CFL, electronic and electromagnetic transformers

For outline drawing see page 5

Output data		
Rated voltage	V AC	230
Power max.	W	400
Power min.	W	2
Nominal lamp ratings 230 V:		
230 V incandescent or halogen W		400
Toroidal electromagnetic transformers for LV halogen W		400
E-core electromagnetic transformers for LV halogen W		400
Electronic transformers (or ballasts) for LV halogen W		400
Dimmable compact fluorescent (CFL) W		100
Dimmable 230 V LED W		100
Dimmable electronic transformers for LV LED W		100
Dimming operating modes		Leading Edge / Trailing Edge
Supply specification		
Type of BUS		KNX
Supply voltage	V DC	30
Rated consumption	mA	7
Technical data		
Ambient temperature range	°C	-5...+45
Protection category		IP 20
Approvals (according to type)		CE UK EAC

## Ordering information

Example: type 15.2K, KNX Universal Dimmer with 2 channels, 230 V AC.

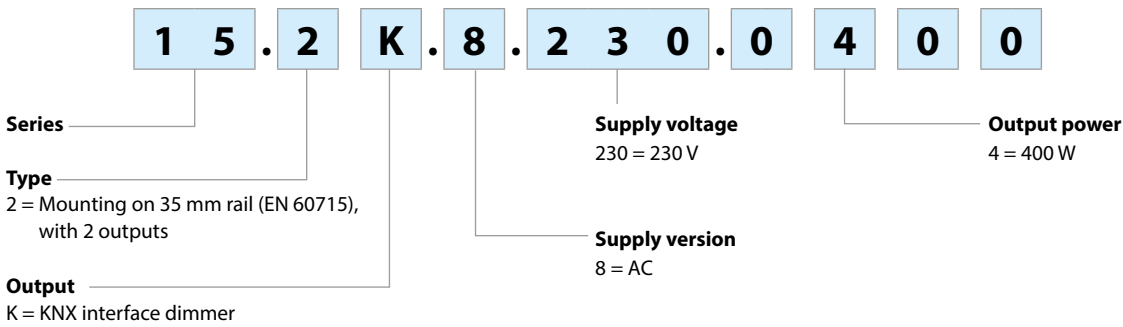

## Technical data

### EMC specifications

Type of test		Reference standard	
Electrostatic discharge	contact discharge	EN 61000-4-2	4 kV
	air discharge	EN 61000-4-2	8 kV
Radiated electromagnetic field	(80...1 000 MHz)	EN 61000-4-3	3 V/m
Fast transients (burst) (5-50 ns, 5 and 100 kHz)	on supply terminals	EN 61000-4-4	4 kV
Voltage pulses on supply terminals (surge 1.2/50 µs)	differential mode	EN 61000-4-5	2.5 kV
Radiofrequency common mode voltage (0.15...80 MHz)	on supply terminals	EN 61000-4-6	3 V
Voltage dips	70% U <sub>N</sub> , 40% U <sub>N</sub>	EN 61000-4-11	10 cycles
Short interruptions		EN 61000-4-11	10 cycles
Radiofrequency conducted emissions	0.15...30 MHz	EN 55014	class B
Radiated emissions	30...1 000 MHz	EN 55014	class B

### Terminals

Max. wire size	solid cable		stranded cable	
	mm <sup>2</sup>	1 x 6 / 2 x 2.5	1 x 4 / 2 x 1.5	
AWG	1 x 10 / 2 x 14	1 x 12 / 2 x 16		
 Screw torque	Nm	0.5		
Wire strip length	mm	7		

## Wiring diagram

Type 15.2K

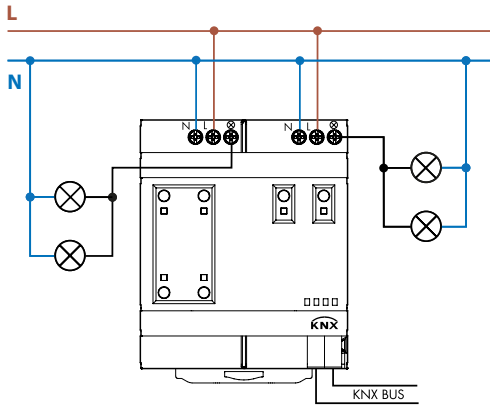

## Outline drawings

Type 15.2K  
Screw terminal

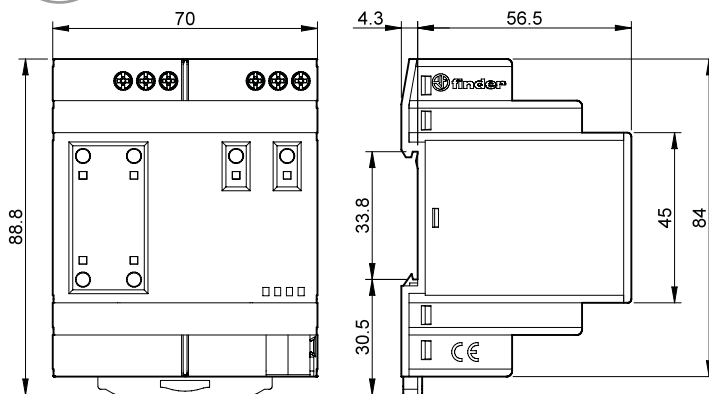





# KNX PIR movement and presence detectors



Hotel room energy-saving units



Lighting control in corridors (for hotels, offices and hospitals)



Offices, swimming baths and schools



Staircase light control



Building and house automation





**KNX movement and presence detectors.**

**Internal installation.**

- 5 outputs (datapoint) for load control (Lighting, HVAC etc.)
- Adjustment of ambient light threshold, and PIR sensitivity
- 1 output (datapoint) – master/slave detection
- Selectable function to inhibit ambient light threshold control
- Reporting of light level and movement status (for security purposes, etc.)
- Detection of movement direction (type 18.4K)
- Internal ceiling mounting
- Suitable for ETS 4 (or latest versions)

18.4K/18.5K  
KNX terminal



For outline drawings see page 4

**Supply specification**

Type of BUS		KNX	KNX
Supply voltage	V DC	30	30
Rated consumption	mA	10	10

**Technical data**

Ambient light intervention threshold	lx	1...1500	1...1500
Light ON time after last detection		0.1 s...18 h	0.1 s...18 h
Sensing area		See diagram page 4	See diagram page 4
Ambient temperature range	°C	-5...+45	-5...+45
Protection category		IP 40	IP 40

**Approvals** (according to type)



**NEW** 18.4K.9.030.0001



**NEW** 18.5K.9.030.0001



- Applications: hotel and offices corridors, transit areas
- Sensing area 30 meters length and 4 meters width
- Two detection areas: right and left
- Dynamic light regulation
- Logic gates
- Up to 5 outputs

- Applications: offices, schools, zones of low activity
- Extensive sensing area up to 64 m<sup>2</sup>
- Dynamic light regulation
- Logic gates
- Up to 5 outputs

### Ordering information

Example: 18 series, KNX PIR movement and presence detector.

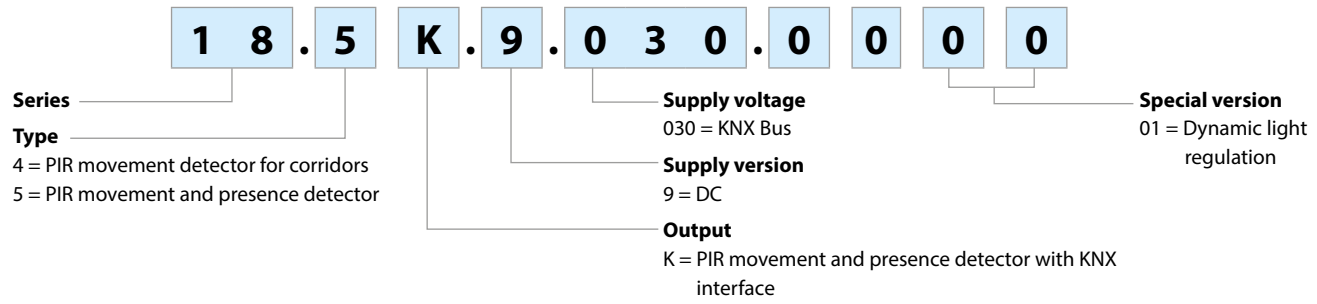

### Sensing area

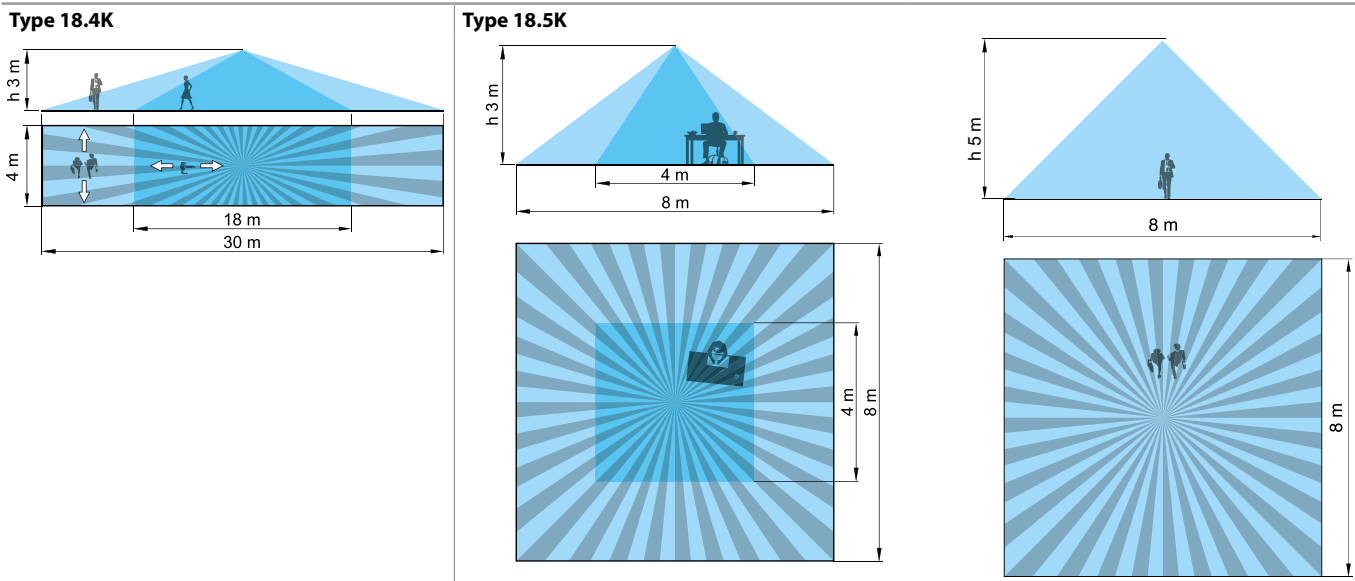

### Outline drawings

Type	Suspended ceiling mounting	Recess mounting	Surface mounting
18.4K			
18.5K			

# KNX Switching actuator 6 channel



Lighting



HVAC



Panels for  
electrical  
distribution



Building and  
house automation





**Switching actuator with KNX technology - 16 A**  
**Compact and powerful switching actuator with 6 relay outputs**

- 6 output contacts rated 16 A 250 V AC, individually configurable NO or NC
- LED status indicator for each output
- Time functions (ON, OFF, Blink, Staircase)
- Independent logic and analog functions for each output (AND, OR, XOR, THRESHOLD, WINDOW)
- Scenario Management
- Output control area for manual control
- Supply voltage via KNX bus
- 35 mm rail (EN 60715) mounting

19.6K  
Screw terminal



**NEW** 19.6K.9.030.4300



- Bistable relay ENEC approved (Maximum peak current up to 120 A)
- Suitable for lamp loads

For outline drawing see page 4

**Contact specification**

Contact configuration (via ETS)		NO - NC (SPST-NO - SPST-NC)
Rated current/Maximum peak current	A	16/120 (5 ms)
Rated voltage/ Maximum switching voltage	V	250/400
Rated load AC1	VA	4000
Rated load AC15 (230 V AC)	VA	750
Single phase motor rating (230 V AC)	kW	0.55
Nominal lamp rating (230 V):		
incandescent/halogen W		2000
fluorescent lamp with electronic ballast W		1000
fluorescent lamp with electromagnetic ballast W		750
CFL W		400
LED 230 V W		400
halogen or LV LED with electronic ballast W		400
halogen or LV LED with electromagnetic ballast W		800
Standard contact material		AgSnO <sub>2</sub>

**Supply specification**

Type of BUS		KNX
Supply voltage	V DC	30
Nominal consumption	mA	15

**Technical data**

Mechanical life	cycles	10 · 10 <sup>6</sup>
Electrical life at rated load AC1	cycles	100 · 10 <sup>3</sup>
Ambient temperature range	°C	-5...+45
Protection category		IP 20

**Approvals** (according to type)



### Ordering information

Example: 19 series, KNX switching actuator, 6 poles 16 A.

**1 9 . 6 K . 9 . 0 3 0 . 4 3 0 0**

**Series**  
**Type**  
6K = KNX actuator, 6 poles 16 A  
**Supply version**  
9 = DC  
**Supply voltage**  
030 = KNX Bus

**Contact circuit**  
3 = NO (ETS configurable)  
**Contact material**  
4 = AgSnO<sub>2</sub>

### Technical data

#### Terminals

Screw torque	Nm	0.5	
Max. wire size	mm <sup>2</sup>	solid cable	stranded cable
		1 x 6 / 2 x 2.5	1 x 4 / 2 x 1.5
		AWG 1 x 10 / 2 x 14	1 x 12 / 2 x 16
Wire strip length	mm	7	

### Wiring diagram

Type 19.6K

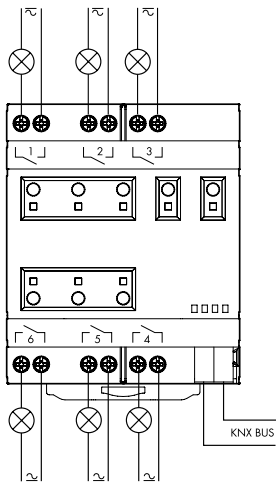

### Outline drawings

Type 19.6K  
Screw terminal

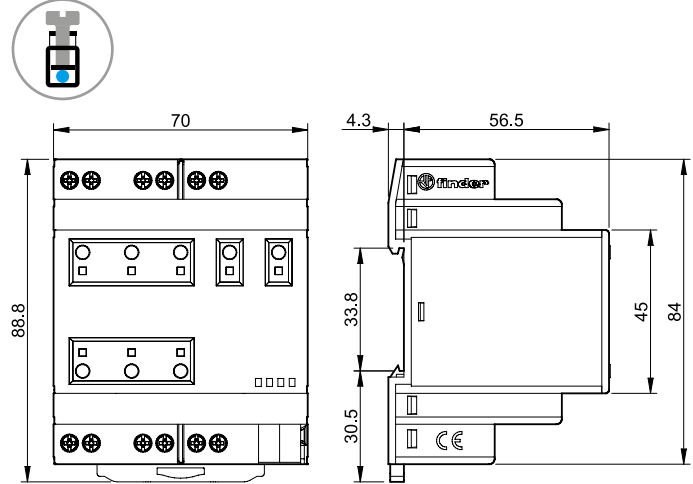

### Accessories

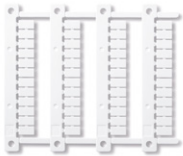

**Sheet of marker tags (CEMBRE Thermal transfer printers) for 19.6K types**  
(48 tags), 6 x 12 mm

060.48

060.48



# KNX Switch mode power supplies



Building and house automation



Automation for blinds and shutters





**KNX power supply with 30 V DC output - 640 mA**

- Output 30 V DC 640 mA, KNX Bus
- Diagnostic LEDs
- 72 mm wide (4 modules)
- 35 mm rail (EN 60715) mount
- Suitable for ETS 4 (or latest versions)

78.2K  
Screw terminal



**NEW** 78.2K.1.230.3000



- Thermal protection, overload protection and short-circuit protection
- Two power supplies can be installed 15 meters apart

For outline drawing see page 6

Output specification		
Output current	mA	640
Output voltage	V	30
Input specification		
Nominal voltage (U <sub>N</sub> )	V AC	230...240
Operating range	V AC	185 - 260
Stand-by power consumption	W	1.45
Power factor		0.62
Max current consumption	A	0.25
Technical data		
Minimum distance between power supplies	m	15
Dielectric strength between input/output	V AC	3000
Ambient temperature range	°C	-5/+45
Protection category		IP 20
<b>Approvals</b> (according to type)		<b>CE UK CA</b>

## Ordering information

Example: 78 series, KNX switch mode power supply, 640 mA output, 230...240 V AC input.

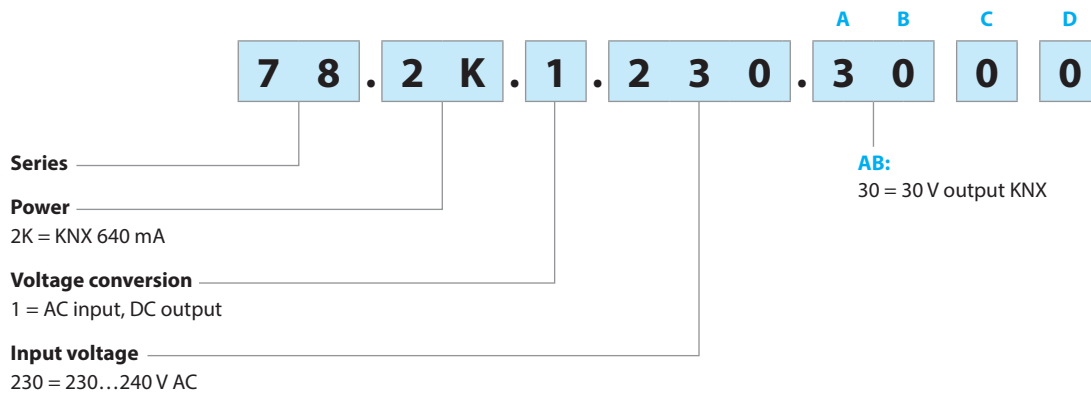











## Technical data

EMC specifications (according to EN 61204-3)		Reference standard	78.2K
Electrostatic discharge	contact discharge	EN 61000-4-2	4 kV
	air discharge	EN 61000-4-2	8 kV
Radiated electromagnetic field	80...1000 MHz	EN 61000-4-3	10 V/m
	1...2.8 GHz	EN 61000-4-3	3 V/m
Fast transients (burst 5/50 ns, 5 and 100 kHz)	HBES terminals	EN 61000-4-4	1 kV
	on supply terminals	EN 61000-4-4	2 kV
Voltage pulses on supply terminals (surge 1.2/50 µs)	DM supply terminals	EN 61000-4-5	1 kV
	CM supply terminals	EN 61000-4-5	2 kV
	HBES terminals	EN 61000-4-5	2 kV
Radio-frequency common mode voltage (0.15...230 MHz)	HBES terminals	EN 61000-4-6	10 V
	on supply terminals	EN 61000-4-6	10 V
Short interruptions	criterion A	EN 61000-4-11	10 cycles
Radio-frequency conducted emissions	0.15...30 MHz	EN 55022	class B
Radiated emissions	30...1000 MHz	EN 55022	class B
<b>Terminals</b>			<b>Max</b>
Wire size (Solid cable, stranded cable)	mm <sup>2</sup>	1 x 4 / 2 x 2.5	
	AWG	1 x 12 / 2 x 14	
 Screw torque	Nm	0.8	
Wire strip length	mm	9	
<b>Other data</b>			
Power lost to the environment with rated output current	W	4.8	

DM: differential mode

CM: common mode

LED table

Type	Area	State	LED	OUTPUT
78.2K.1.230.3000	CHECK START UP	$V_{out}$ OK	 • OFF • OFF	ON
		$V_{out}$ LOW < 29V	 • OFF • OFF	OFF
		$V_{out}$ HIGH > 33V	• OFF  • OFF	OFF
	NORMAL FUNCTION	$V_{out}$ OK $I_{out}$ > 0.9A	 • OFF 	ON
		$V_{out}$ < 29V $I_{out}$ > 0.9A	• OFF • OFF 	ON
	 Alarm condition: $T_{amb} > 45^{\circ}\text{C}$ @ $I_{nom}$ .	Pre-alarm: up to 60s	 • OFF 	ON
		Latched alarm	• OFF • OFF 	OFF

## Output specification

FB78-6 Output voltage v output current (78.2K)

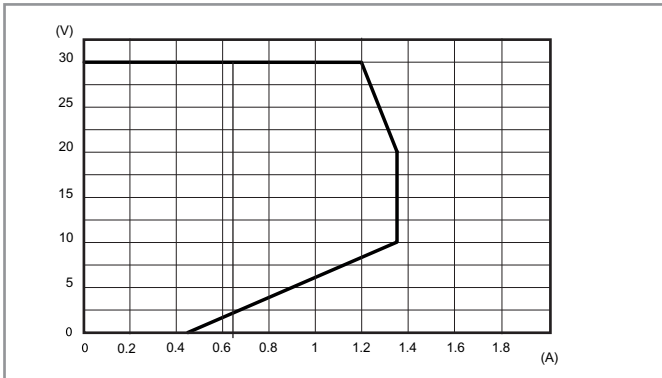

Overload diagram, KNX approved

## Wiring diagram

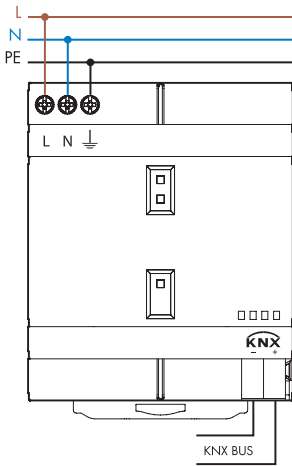

## Outline drawings

Type 78.2K  
Screw terminal

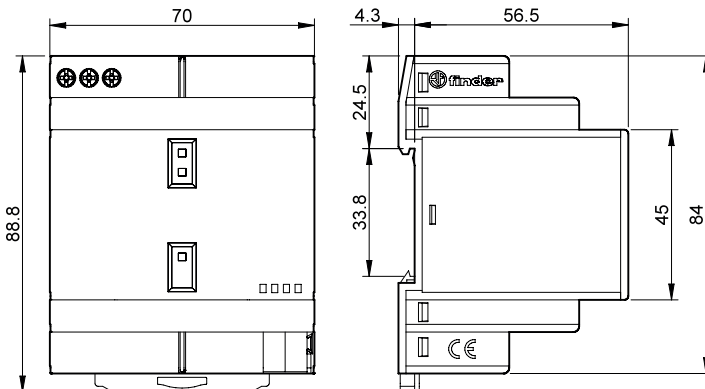

# KNX interfaces

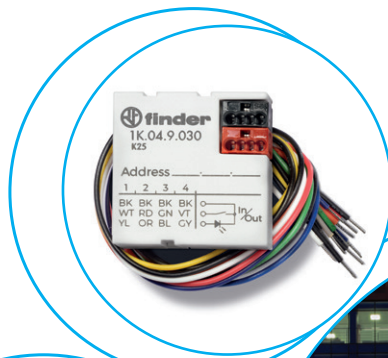

Computer interface



Dry contacts interface



Logic functions



Programming through ETS







**KNX Universal interface**

**1K.02 - 2 input – 2 LEDs**

**1K.04 - 4 input – 4 LEDs**

- Available with 2 or 4 inputs
- 8 advanced logic functions
- Compact size
- Status LED managing



Includes 2 digital inputs for dry contacts and 2 outputs for LEDs.  
 Device 1K.04.9030 includes 4 digital inputs for dry contacts and 4 outputs for LEDs.  
 These devices (only 34 x 34 x 11 mm) can also be used in installations where the inwall space available is reduced.  
 The digital inputs can interface sensors, traditional buttons, etc.  
 The low voltage output channels can drive LEDs for synoptic panels or switches

For outline drawing see page 6

**Supply specification**

Type of BUS		KNX
Supply voltage	V DC	30
<b>Technical data</b>		
Logic functions		AND, OR, NOT, XOR, NOR, NAND, XNOR, Byte to bit and bit to byte conversions, 1, 2 and 4 bytes threshold
Software compatibility		ETS 5 (or above)
Ambient temperature range	°C	-5...+45
Protection category		IP 40
<b>Approvals</b> (according to type)		—

**KNX USB interface****1K.UB - USB interface for KNX BUS**

- Standard KNX TP backbone
- USB type-B connector
- Compact size, one module wide
- LED indicating BUS status



The modular USB Finder interface has 1 module DIN BAR-mounting size.

Thanks to it you can connect the PC through the USB port in order to manage your KNX system through the ETS software taking up the least possible space.

For outline drawing see page 6

**Supply specification**

Type of BUS		KNX
Supply voltage	V DC	30
<b>Technical data</b>		
Software compatibility		ETS 3 (or above)
Ambient temperature range	°C	-5...+45
Protection category		IP 40
<b>Approvals</b> (according to type)		—

### Ordering information

Example: 1K Series, KNX universal interfaces with 2 IN / 2 OUT, in-wall mounting.

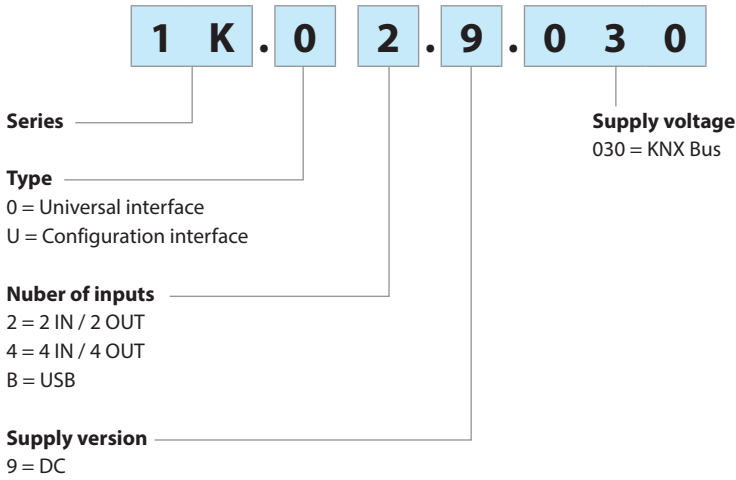

### Wiring diagram

**Type 1K.02**

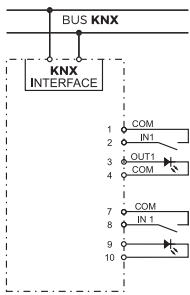

**Type 1K.04**

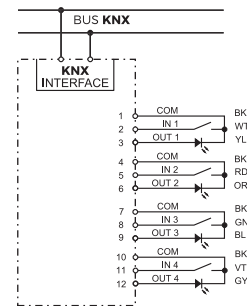

### Wired cable

**Type 1K.02 and 1K.04**

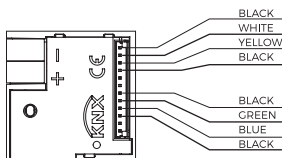
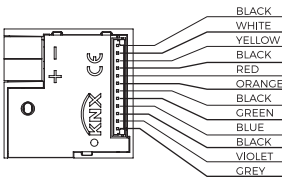

**Wired cable for 1K.02.9030**

- |     |               |          |
|-----|---------------|----------|
| 1.  | BLACK         | COM      |
| 2.  | WHITE         | INPUT 1  |
| 3.  | YELLOW        | OUTPUT 1 |
| 4.  | BLACK         | COM      |
| 5.  | NOT CONNECTED |          |
| 6.  | NOT CONNECTED |          |
| 7.  | BLACK         | COM      |
| 8.  | GREEN         | INPUT 3  |
| 9.  | BLUE          | OUTPUT 3 |
| 10. | BLACK         | COM      |
| 11. | NOT CONNECTED |          |
| 12. | NOT CONNECTED |          |

**Wired cable for 1K.04.9030**

- |     |        |          |
|-----|--------|----------|
| 1.  | BLACK  | COM      |
| 2.  | WHITE  | INPUT 1  |
| 3.  | YELLOW | OUTPUT 1 |
| 4.  | BLACK  | COM      |
| 5.  | RED    | INPUT 2  |
| 6.  | ORANGE | OUTPUT 2 |
| 7.  | BLACK  | COM      |
| 8.  | GREEN  | INPUT 3  |
| 9.  | BLUE   | OUTPUT 3 |
| 10. | BLACK  | COM      |
| 11. | VIOLET | INPUT 4  |
| 12. | GRAY   | OUTPUT 4 |

## Outline drawings

Types 1K.02 / 04

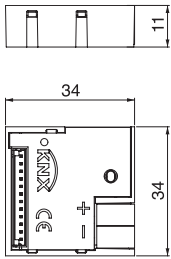

Type 1K.UB

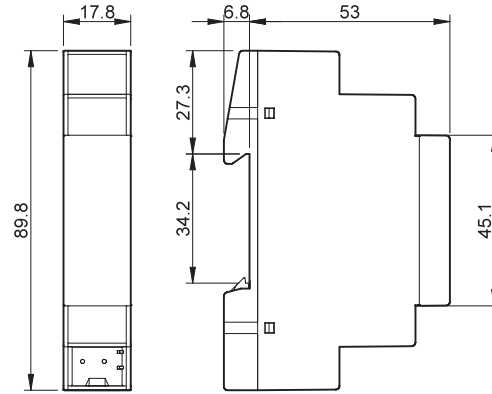

# Index - General technical information

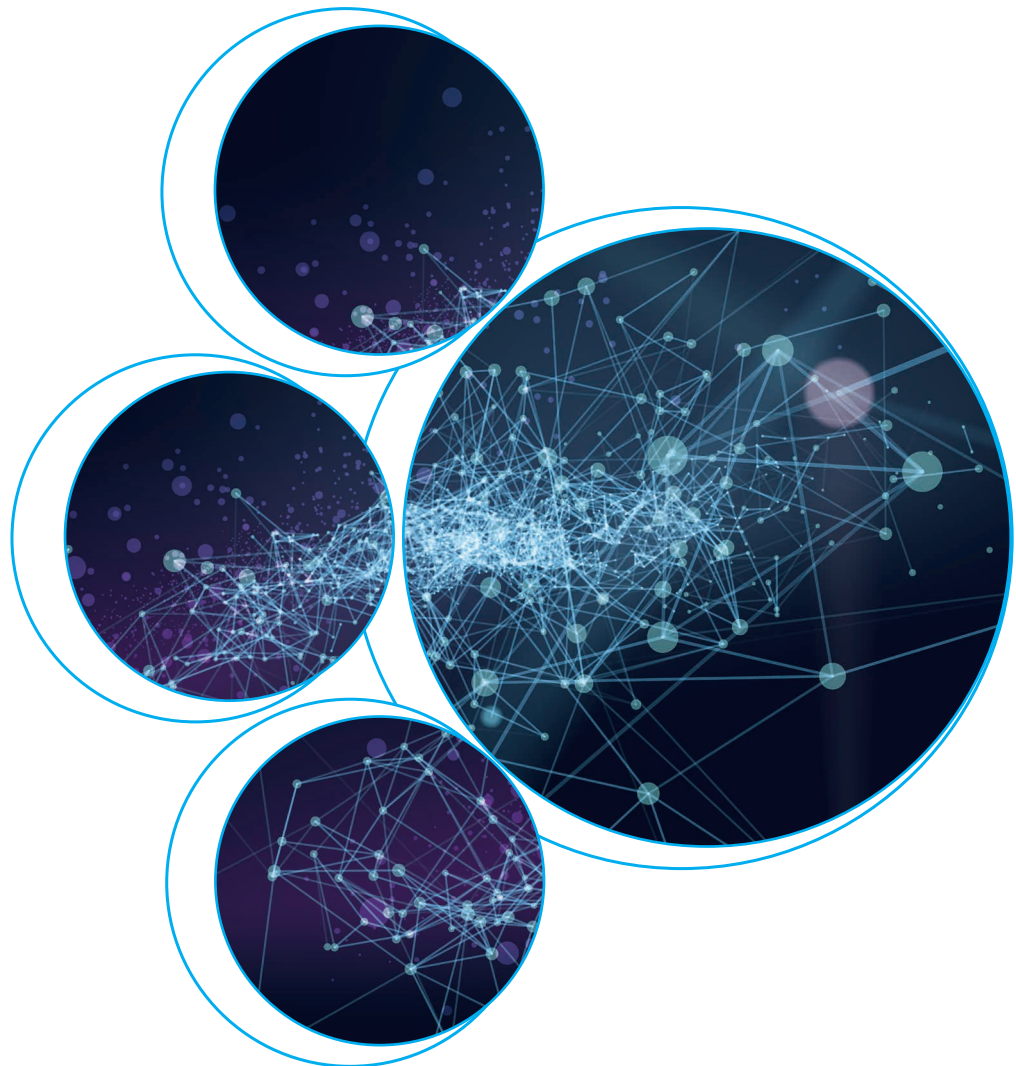



Terms	Page	col.		
Reference standards	IV	1	Vibration resistance	XVI 1, 2
Reference values and tolerances	IV	1	Shock resistance	XVI 2
Regulations for storage and handling of goods	IV	1	Installed orientation	XVI 2
Operating & installation conditions	IV	2	Power lost to the environment	XVI 2
Coil operating range	IV	2	Recommended distance between relays mounted on printed circuit boards	XVI 2
Excessive peak voltage limiting	IV	2	Torque	XVI 2
Residual current	IV	2	Minimum Wire size	XVI 2
Ambient temperature	IV	2	Max. wire size	XVI 2
Condensation	IV	2	Terminating more than one wire	XVI 2
Installed orientation	IV	2	Box clamp	XVI 2
RC contact suppression	IV	2	Plate clamp	XVI 2
Guidelines for automatic flow solder processes	IV	2	Screwless terminal (Spring clamp)	XVI 2
Relay mounting	IV	2	Push-in terminal	XVI 2
Flux application	IV	2	Jumper link	XVI 2
Preheating	V	1	SSR - Solid State Relay	XVII 1
Soldering	V	1	SSR Solid State Relay	XVII 1
Cleaning	V	1	Opto-coupler	XVII 1
Terminology & definitions	V	1	Switching voltage range	XVII 1
Terminal marking	V	1	Minimum switching current	XVII 1
Contact specification	V	2	Control current	XVII 1
Contact Set	V	2	Maximum blocking voltage	XVII 1
Single contact	V	2	Relay with forcibly guided (mechanically linked) contacts, or safety relay	XVII 1
Twin/Bifurcated contact	V	2	Monitoring and Measuring relays	XVII 1
Double break contact	V	2	Supply voltage monitoring	XVII 1
Micro interruption	V	2	3-phase asymmetry monitoring	XVII 1
Micro disconnection	V	2	Detection level	XVII 1
Full disconnection	V	2	Switch-on lock-out time	XVII 2
Rated current	V	2	Start delay (T2)	XVII 2
Maximum peak current	V	2	Switch-off time	XVII 2
Rated switching voltage	V	2	Trip on-delay	XVII 2
Maximum switching voltage	V	2	Run-on time	XVII 2
Rated load AC1	VI	1	Reaction time	XVII 2
Rated load AC15	VI	1	Fault memory	XVII 2
Single-phase motor rating	VI	1	Fault memory - status retained on power down	XVII 2
Nominal lamp ratings	VI	1	Switch-ON hysteresis	XVII 2
Breaking capacity DC1	VI	1	Thermistor temperature sensing	XVII 2
Minimum switching load	VI	1	Level control relay	XVII 2
Electric life tests	VI	1	Electrode voltage	XVII 2
Electrical life "F-chart"	VI	2	Electrode current	XVII 2
Load reduction factor versus Cos φ	VI	2	Max. sensitivity	XVII 2
Capacitor start motors	X	1	Sensitivity, fixed or adjustable	XVIII 1
Three-phase alternating current loads	XII	1	Positive safety logic	XVIII 1
Three-phase motors	XII	1	Timers	XVIII 1
Switching different voltages within a relay	XII	2	Specified time range	XVIII 1
Contact resistance	XII	2	Repeatability	XVIII 1
Contact categories according to EN 61810-7	XII	2	Recovery time	XVIII 1
Coil specification	XIII	1	Minimum control impulse	XVIII 1
Nominal voltage	XIII	1	Setting accuracy	XVIII 1
Rated power	XIII	1	Light dependent relays	XVIII 1
Operating range	XIII	1	Threshold setting	XVIII 1
Non-operate voltage	XIII	1	Delay time	XVIII 1
Minimum Pick-up voltage (Operate voltage)	XIII	1	Time switches	XVIII 1
Maximum permitted voltage	XIII	1	1 or 2 pole output types	XVIII 1
Holding voltage (Non-release voltage)	XIII	1	Type of time switch	XVIII 1
Must drop-out voltage (Must release voltage)	XIII	1	Programs	XVIII 1
Coil Resistance	XIII	1	Minimum interval setting	XVIII 2
Rated coil consumption	XIII	1	Power back-up	XVIII 2
Thermal tests	XIII	2	Step relays and staircase timers	XVIII 2
Monostable relay	XIII	2	Minimum/Maximum impulse duration	XVIII 2
Bistable relay	XIII	2	Max. number of illuminated push-buttons	XVIII 2
Latching relay	XIII	2	Glue wire conformity according to EN 60335-1	XVIII 2
Remanence relay	XIII	2	EMC (ElectroMagnetic Compatibility) Standards	XVIII 2
Insulation	XIII	2	Burst (fast transients)	XIX 1
Relay function and Isolation	XIII	2	Surge (voltage pulses)	XIX 1, 2
Specifying isolation levels	XIII	2	EMC rules	XIX 2
Insulation coordination	XIV	1	Reliability (MTTF & MTBF for equipment)	XIX 2
Nominal voltage of supply system	XIV	2	MTBF, MTTF and MCTF	XIX 2
Rated Insulation Voltage	XIV	2	MCTF, B <sub>10</sub> and B <sub>10d</sub> for Finder relays	XIX 2
Dielectric strength	XIV	2	The RoHS, REACH & WEEE directives	XX 1
Insulation Group	XV	1	Cadmium	XX 1
SELV, PELV and Safe separation	XV	1	SIL and P L categories	XX 1
The SELV system	XV	1	SIL Classes - according to EN 62061	XX 2
The PELV system	XV	1	P L Classes - according to EN ISO 13849-1	XX 2
General technical data	XV	2	Points of commonality between EN 62061 and EN ISO 13849-1	XX 2
Cycle	XV	2	Component reliability	XX 2
Period	XV	2	Certifications and Quality Approvals	XXI —
Duty factor (DF)	XV	2	Tables	TABLE 1 Contact load classifications
Continuous operation	XV	2	TABLE 2.1  Certified products ratings	VIII, IX —
Mechanical life	XV	2	TABLE 2.2  Certified products ratings	X —
Operate time	XV	2	TABLE 2.3  Certified sockets ratings	XI —
Release time	XV	2	TABLE 3 Motor ratings v relay series	XII 1
Bounce time	XV	2	TABLE 4 Contact categories	XII 2
Ambient temperature	XVI	1	TABLE 5 Contact materials characteristics	XII 2
Ambient temperature range	XVI	1	TABLE 6 Rated impulse voltage	XIV 2
Storage temperature range	XVI	1	TABLE 7 Pollution degree	XIV 2
Environmental protection	XVI	1		
Protection category	XVI	1		

## Reference standards

Unless expressly indicated otherwise, the products shown in this catalogue are designed and manufactured according to the requirements of the following European and International Standards:

- **EN 61810-1**, **EN 61810-2**, **EN 61810-7** for electromechanical elementary relays
- **EN 61810-3** for relays with forcibly guided contacts
- **EN 61812-1** for timers
- **EN 60669-1** and **EN 60669-2-2** for electromechanical step relays
- **EN 60669-1** and **EN 60669-2-1** for light-dependent relays, electronic step relays, light dimmers, staircase switches, time switches, movement detectors and monitoring relays.

Other important standards, often used as reference for specific applications, are:

- **EN 60335-1** and **EN 60730-1** for domestic appliances
- **EN 50178** for industrial electronic equipments

## Reference values and tolerances

Unless expressly indicated otherwise, all technical data is specified under the following environmental conditions:

- ambient temperature:  $23\text{ °C} \pm 5\text{ K}$
- pressure:  $96 \pm 10\text{ kPa}$
- humidity:  $50 \pm 25\%$
- altitude: from sea level to 2000 m. Higher altitudes will not affect current or temperature ratings, but will require a de-rating of the rated impulse voltage - which must be reduced by 14% at 3000 m, 29% at 4000 m, 48% at 5000 m

The following tolerances apply:

- coil resistance, rated consumption and rated power:  $\pm 10\%$
- frequency:  $\pm 2\%$
- dimensions indicated in the mechanical drawings:  $\pm 0.1\text{ mm}$

## Regulations for storage and handling of goods

All Finder products are packaged individually and / or in multiple packages and boxes that are designed to facilitate warehousing, identification, storage and handling.

To ensure optimum performance and quality over time, the following regulations must be adhered to:

- ALWAYS move pallets by forklift and / or other suitable equipment for moving and handling goods.
- Handle products with caution, avoiding dropping, falling or other violent mechanical stress (such as shock, compression and abrasion) that could compromise their integrity and functionality.
- Store the product in dry areas, in accordance with the "storage temperature range" guidelines.
- Maintain in the vertical position the packages and boxes, which have been designed to protect the contents more effectively this way.
- To simplify the identification and traceability of products, store them in their original packaging until they are used.
- Keep the original packaging closed, in order to avoid the accumulation of dust on the products; and to reduce their exposure to direct sunlight.
- In cases such as e-commerce, when and where necessary, use additional packaging to avoid potential damage from automatic sorting systems.
- Avoid using products found in packaging with visible signs of damage or tampering.

## Operating & installation conditions

### Coil operating range

In general, Finder relays will operate over the full specified temperature range, according to:

- Class 1 - 80% to 110% of nominal coil voltage, or
- Class 2 - 85% to 110% of nominal coil voltage.

Outside the above Classes, coil operation is permitted according to the limits shown in the appropriate "R" chart.

Unless expressly indicated otherwise, all relays are suitable for 100% Duty Cycle (continuous energisation) and all AC coil relays are suitable for 50 and 60 Hz frequency.

### Excessive peak voltage limiting

Overvoltage protection (varistor for AC, diode for DC) is recommended in parallel with the coil for nominal voltages  $\geq 110\text{ V}$  for the relays of 40, 41, 44, 46 series. LED + Varistor (for AC) or LED + diode (for DC) 99 series modules are perfectly suitable for this purpose.

### Residual current

When AC relay coils are controlled via a proximity switch, or via cables having length  $> 10\text{ m}$ , the use of a 99 series "residual current bypass" module is recommended, or alternatively, fit a resistor of  $62\text{ k}\Omega/1\text{ watt}$  in parallel with the coil.

### Ambient temperature

The Ambient temperature as specified in the relevant specification and "R" chart relates to the immediate environment in which the component is situated, as this may be greater than the ambient temperature in which the equipment is located. Refer to page [XIV](#) for more detail.

### Condensation

Environmental conditions causing condensation or ice formation in the relay are not permitted.

### Installed orientation

The component's specification is unaffected (unless expressly stated otherwise) by its orientation, (provided it is properly retained, eg by a retaining clip in the case of socket mounted relays).

### RC contact suppression

If a resistor/capacitor network is placed across a contact to suppress arcing, it should be ensured that when the contact is open, the leakage current through the RC network does not give rise to a residual voltage across the load (typically the coil of another relay or solenoid) any greater than 10% of the load's nominal voltage - otherwise, the load may hum or vibrate, and reliability can be affected. Also, the use of an RC network across the contact will destroy the isolation normally afforded by the contact (in the open position).

## Guidelines for automatic flow solder processes

In general, an automatic flow solder process consists of the following stages:

### Relay mounting

Ensure that the relay terminals are straight and enter the PC board perpendicular to the PC board. For each relay, the catalogue illustrates the necessary PC board hole pattern (copper side view). Because of the weight of the relay, a plated through hole printed circuit board is recommended to ensure a secure fixation.

### Flux application

This is a particularly delicate process. If the relay is not RT II or RT III rated (see page [XIV](#)), flux may penetrate the relay due to capillary forces, changing its performance and functionality.

Whether using foam or spray fluxing methods, ensure that flux is applied sparingly and evenly and does not flood through to the component side of the PC board.

By following the above precautions, and assuming the use of alcohol or water based fluxes, it is possible to satisfactorily use relays with protection category RT II or RT III.



**Preheating**

Set the preheat time and heat to just achieve the effective evaporation of the flux, taking care not to exceed a component side temperature of 120 °C (248 °F).

**Soldering**

Set the height of the molten solder wave such that the PC board is not flooded with solder. Ensure the solder temperature and time are kept to 260 °C (500 °F) and 5 seconds maximum.

**Cleaning**

The use of modern "no-clean" flux avoids the necessity of washing the PC boards.

In special cases, where the PC board must be washed, the use of wash-tight relays (option xxx1 - RT III) is mandatory.

In such case, after the soldering and before starting any cleaning process, it is necessary to assure an appropriate cooling of the assemblies, in order to reduce thermal stress and avoid pressure difference between relay interior and ambient, both conditions which could cause cracking of the sealing.

Ultrasonic cleaning is generally not allowed. Aggressive solvents must be avoided: the user should establish compatibility between his cleaning fluid and the relay plastics. In washing cycles, the solvent temperature must not be higher than 50 °C, and the difference of the temperature of cleaning and rinsing liquids must not exceed 10 °C.

After cleaning it is suggested to break the pin on the relay cover. This is necessary to guarantee the electrical life at maximum load as quoted in the catalogue; otherwise ozone generated inside the relay (dependent on the switching load and frequency) will significantly reduce the electrical life.

**Terminology & definitions**

All the following terms used in the catalogue are commonly used in technical language. However, occasionally, National, European or International Standards may prescribe the use of different terms, in which case these will be mentioned in the appropriate descriptions that follow.

**Terminal marking**

European Standard EN 50005 recommends the following numbering for the marking of relay terminals:

- .1 for common contact terminals (e.g. 11, 21, 31...)
- .2 for NC contact terminals (e.g. 12, 22, 32...)
- .4 for NO contact terminals (e.g. 14, 24, 34...)
- A1 and A2 for coil terminals
- B1, B2, B3 etc. for Signal inputs
- Z1 & Z2 for potentiometer or sensor connection

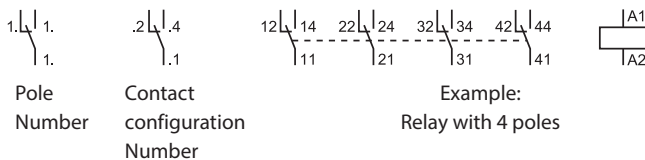

For delayed contacts of timers the numbering will be:

- .5 for common contact terminals (e.g. 15, 25,...)
- .6 for NC contact terminals (e.g. 16, 26,...)
- .8 for NO contact terminals (e.g. 18, 28,...)

American standards prescribes:

progressive numbering for terminals (1,2,3,...13,14,...) and sometimes A and B for coil terminals.

**Contact specification**

Symbol	Configuration	EU	D	GB	USA
	Make contact (Normally Open)	NO	S	A	SPST-NO DPST-NO nPST-NO
	Break contact (Normally Closed)	NC	Ö	B	SPST-NC DPST-NC nPST-NC
	Changeover	CO	W	C	SPDT DPDT nPDT

n = number of poles (3,4,...), S = 1 and D = 2

**Contact Set**

The contact set comprises all the contacts within a relay.

**Single contact**

A contact with only one point of contact.

**Twin/Bifurcated contact**

A contact with two points of contact, which are effectively in parallel with each other. Very effective for switching small contact loads such as analogue, transducer, low signal or PLC input circuits.

**Double break contact**

A contact comprising two points of contact in series with each other. Particularly effective for switching DC loads. The same effect can be achieved by wiring two single contacts in series.

**Micro interruption**

Interruption of a circuit, without any specific requirements for distance or dielectric strength across the contact gap. All Finder relays comply or exceed this.

**Micro disconnection**

Adequate contact separation in at least one contact so as to provide functional safety. A dielectric strength requirement must be achieved across the contact gap. All Finder relays comply with this class of disconnection.

**Full disconnection**

Contact separation for the disconnection of conductors so as to provide the equivalent of basic insulation between those parts intended to be disconnected. There are requirements for both the dielectric strength and the dimensioning of the contact gap. Several Finder relays comply with this category of disconnection.

**Rated current**

This coincides with the *Limiting continuous current* - the highest current that a contact can continuously carry within the prescribed temperature limits. It also coincides with the *Limiting cycling capacity*, i.e. the maximum current that a contact is capable of making and breaking under specified conditions. In virtually all cases the Rated current is also the current that, when associated with the Rated switching voltage, gives rise to the Rated load (AC1). (The exception being the 30 series relay).

**Maximum peak current**

The highest value of inrush current ( $\leq 0.5$  seconds) that a contact can make and cycle (duty cycle  $\leq 0.1$ ) without undergoing any permanent degradation of its characteristics due to generated heat. It also coincides with the *Limiting making capacity*.

**Rated switching voltage**

This is the switching voltage that when associated with the Rated current gives rise to the Rated load (AC1). The Rated load is used as the reference load for electrical life tests.

**Maximum switching voltage**

This represents the maximum nominal voltage that the contacts are able to switch and for the relay to meet the insulation and design requirements called for by the insulation coordination standards.

**Rated load AC1**

The maximum AC resistive load (in VA) that a contact can make, carry and break repeatedly, according to classification AC1 (see Table 1). It is the product of rated current and rated voltage, and is used as the reference load for electrical life tests.

**Rated load AC15**

The maximum AC inductive load (in VA) that a contact can make, carry and break repeatedly, according to classification AC15 (see Table 1), called “AC inductive load” in EN 61810-1, Annex B.

**Single-phase motor rating**

The nominal value of motor power that a relay can switch. (The figures are given in kW; the horsepower rating can be calculated by multiplying the kW value by 1.34 i.e. 0.37 kW = 0.5 HP).

Note: “inching” or “plugging” is not permitted.

If reversing motor direction, always allow an intermediate break of > 300 ms, otherwise an excessive inrush peak current (caused from change of polarity of motor capacitor) may occur, causing contact welding.

**Nominal lamp ratings**

Lamp ratings for 230 V AC supply for:

- Incandescent (or halogen) lamps
- Fluorescent lamps with electronic or electromechanical ballast
- CFL (Compact Fluorescent Lamps) or LED lamps
- LV (Low voltage) halogen or LED lamps with electronic or electromechanical ballast

**Breaking capacity DC1**

The maximum value of DC resistive current that a contact can make, carry and break repeatedly, according to classification DC1 (see Table 1).

**Minimum switching load**

The minimum values of power, voltage and current that a contact can reliably switch. For example, if minimum values are 300 mW, 5 V/5 mA:

- with 5 V the current must be at least 60 mA;
- with 24 V the current must be at least 12.5 mA;
- with 5 mA the voltage must be at least 60 V.

For gold contact variants, loads no less than 50 mW, 5V/2 mA are suggested. With 2 gold contacts in parallel, it is possible to switch 1 mW, 0.1 V/1 mA.

**Test conditions for contact data and charts**

Unless otherwise specified, the following test conditions apply:

- Tests performed at the maximum ambient temperature.
- Relay coil (AC or DC) energised at rated voltage.
- Load test applied to the NO contacts; generally the rated AC1 current for the NC contacts is the same, but the electrical life and/or the other ratings (AC15, DC, motor, lamp) can be lower, information on request. For a CO contact, the rated values and third-party life tests are based on a single load being controlled by either the NO or the NC side, but a “secondary” load ≤10% of the rated load is generally acceptable on the other side of the CO.
- Switching frequency for elementary relays: 900 cycles/h with 50% duty cycle (can be 25% or less for relays with rated current ≥16 A).
- Switching frequency for step relays: 900 cycles/h for the coil, 450 cycles/h for the contact, 50% duty cycle.
- Electrical life expectancy values and ratings other than AC1 (AC15, DC, motor, lamp) are generally valid for relays with standard contact material; data for optional materials are available on request.

**Electric life tests**

The Electrical life at rated load AC1, as specified in the Technical data, represents the life expectancy for an AC resistive load at rated current and 250 V.

(This value can be used as the relay B<sub>10</sub> Value; see “Electrical life “F-chart” and “Reliability” sections).

**Electrical life “F-chart”**

The “Electrical life (AC) v contact current” chart indicates the life expectancy for an AC resistive load for different values of contact current. Some charts also indicate the results of electrical life tests for inductive AC loads

In general, the reference load voltage applicable to these life expectancy charts is Un = 250 V AC. However, the life indicated can also be assumed to be approximately valid for voltages between 125 V to 277 V. Where the life expectancy chart shows a curve for 440 V, the life indicated can also be assumed to be approximately valid for voltages up to 480 V.

Note: Life, or number of cycles, from these charts can be taken as indicating the B<sub>10</sub> statistical value for the purposes of reliability calculations. And, this value multiplied by 1.4 could be taken as an approximation to the related MCTF (Mean Cycles To Failure) figure. (Failure, in this case, refers to the contact “wear-out” mechanism that occurs at relatively high contact loads.)

Predicting life expectancy at voltages lower than 125 V:

For load voltages < 125 V (i.e. 110 or 24 V AC), the electrical life will rise significantly with decreasing voltage. (A rough estimate can be made using a multiplying factor of 250/2Un and applying it to the life expectancy appropriate to the 250 V load voltage).

Estimating switching current at voltages greater than 250 V:

For load voltages higher than 250 V (but less than the maximum switching voltage specified for the relay), the maximum contact current should be limited to the Rated load AC1 divided by the voltage being considered. For example, a relay with rated current and rated load AC1 of 16 A and 4000 VA respectively, is able to switch a maximum current of 10 A at 400 V AC: the corresponding electrical life will be approximately the same as that at 16 A/250 V.

**Load reduction factor versus Cos φ**

The load current for AC loads which comprise both an inductive and resistive component can be estimated by applying a reduction factor (k) to the resistive contact current (according to the load’s Cos φ). Such loads should not be taken as appropriate for electric motors or fluorescent lamps, where specific ratings are quoted. They are however, appropriate for inductive loads where the current and Cos φ are substantially the same at “make” and “break”, and are also widely specified by international relay standards as reference loads for performance verification and comparison.

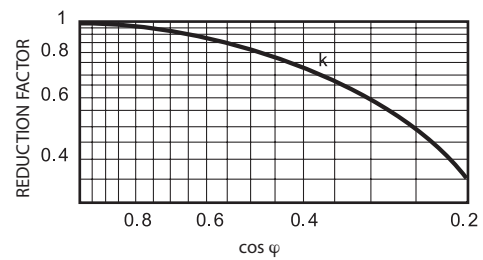

**TABLE 1 Contact load classifications**

(related to the utilization categories defined in EN 60947-4-1 and EN 60947-5-1)

Load classification	Supply type	Application	Switching with relay
AC1	AC single-phase AC three-phase	Resistive or slightly Inductive AC loads.	Work within the relay data.
AC3	AC single-phase AC three-phase	Starting and stopping of Squirrel cage motors. Reversing direction of rotation only after motor has stopped rotating. <u>Three-phase:</u> Motor reversal is only permitted if there is a guaranteed break of 50 ms between energisation in one direction and energisation in the other. <u>Single-phase:</u> Provision of 300 ms “dead break” time when neither relay contacts are closed - during which time the capacitor discharges harmlessly through the motor windings.	For single-phase: keep to the relay data. For three-phase: see “Three-phase motors” section.
AC4	AC three-phase	Starting, Stopping and Reversing direction of rotation of Squirrel cage motors. Jogging (Inching). Regenerative braking (Plugging).	Not possible using relays. Since, when reversing a phase connection, severe contact arcing will occur.
AC14	AC single-phase	Control of small electromagnetic loads (< 72 VA), power contactors, magnetic solenoid valves, and electromagnets.	Assume a peak inrush current of approx. 6-times rated current, and keep this within the the specified “Maximum peak current” for the relay.
AC15	AC single-phase	Control of small electromagnetic loads (> 72 VA), power contactors, magnetic solenoid valves, and electromagnets.	Assume a peak inrush current of approx. 10-times rated current, and keep this within specified “Maximum peak current” for the relay.
DC1	DC	Resistive loads or slightly inductive DC loads. (The switching voltage at the same current can be doubled by wiring 2 contacts in series).	Work within relay data (see the diagram “Maximum DC1 breaking capacity”).
DC13	DC	Inductive DC loads such as contactor coils, electrovalves, electromagnets	This assumes no inrush current, although the switch off over-voltage can be up to 15 times the rated voltage. An approximation of the relay rating on a DC inductive load with 40 ms L/R can be made using 50% of the DC1 rating. If a freewheeling diode is wired in parallel to the load, it can be considered the same value as DC1. See the diagram “Maximum DC1 breaking capacity”

**TABLE 2.1** **Certified products ratings**

R = Resistive / GP = General Purpose / GU = General Use / SB = Standard Ballast / I = Inductive (cosφ 0.4) / B = Ballast / NO = N.O. type

Type	UL file No.	Ratings			Open Type Devices	Pollution degree	Max Surrounding Air Temperature	
		AC/DC	"Motor Load" Single phase					
			110-120	220-240				
34.51	E106390	6 A – 250 Vac (GP)			B300 – R300	Yes	2	40 °C
34.81.7.XXX.7048	E106390	0.1 A – 48 Vdc (GU)	/	/	/	Yes	1	70 °C
34.81.7.XXX.7220	E106390	0.2 A – 220 Vdc (GU)	/	/	/	Yes	1	70 °C
34.81.7.XXX.8240	E106390	2 A – 277 Vac (GU)	/	/	1.25 A-120 Vac 0.63 A-240 Vac	Yes	1	50 °C
34.81.7.XXX.9024	E106390	6 A – 24 Vdc (GU)	/	/	1.5 A – 24 Vdc	Yes	1	70 °C
40.31 – 40.51	E81856	10 A – 250 Vac (R)		1/3 Hp (250 V)	/	Yes	/	85 °C
40.52	E81856	8 A – 250 Vac (R) 8 A – 277 Vac (GP) 8 A – 30 Vdc (GP)	1/6 Hp (4.4 FLA)	1/3 Hp (3.6 FLA)	R300	Yes	/	85 °C
40.61	E81856	15 A – 250 Vac (R)		½ Hp (250 V)	/	Yes	/	85 °C
40.31 – 40.51 NEW	E81856	12 A – 277 Vac (GU) 12 A – 30 Vdc (GU)	1/3 Hp (7.2 FLA/43.2 LRA)	¾ Hp (6.9 FLA/41.4 LRA)	B300	Yes	2 or 3	85 °C
40.52 NEW	E81856	8 A – 250 Vac (R) 8 A – 277 Vac (GP) 8 A – 30 Vdc (GP)	1/4 Hp	1/2 Hp	B300	Yes	2 or 3	85 °C
40.61 NEW	E81856	16 A – 277 Vac (GU) 16 A – 30 Vdc (GU) (AgCdO) 12 A – 30 Vdc (GU) (AgNi) 16 A – 24 Vdc (GU) (AgSnO <sub>2</sub> )	1/3 Hp (7.2 FLA/43.2 LRA)	¾ Hp (6.9 FLA/41.4 LRA)	B300	Yes	2 or 3	85 °C
40.62	E81856	10 A – 277 Vac (GU) 10 A – 24 Vdc (GU)	¼ Hp (only NO)	½ Hp (AgNi) (Only NO) ¾ Hp (AgSnO <sub>2</sub> ) (Only NO)	B300 (Only NO) 1 A – 30 Vdc (Only NO)	Yes	2 or 3	85 °C
40.11 – 40.41	E81856	10 A – 240 Vac (R) 5 A – 240 Vac (I) 10 A – 250 Vac (GP) 8 A – 24 Vdc 0.5 A – 60 Vdc 0.2 A – 110 Vdc 0.12 A – 250 Vdc	/	½ Hp (250 V)	/	Yes	/	70 °C
41.31	E81856	12 A – 277 Vac (GU) 12 A – 277 Vac (R)	1/4 Hp (5.8 FLA)	½ Hp (4.9 FLA)	B300 – R300	Yes	2 or 3	40 or 70 °C with a minimum distance among relay of 5 mm
41.61	E81856	16 A – 277 Vac (GU-R) 8 A – 277 Vac (B)	¼ Hp (5.8 FLA)	½ Hp (4.9 FLA)	B300 – R300	Yes	2 or 3	40 or 70 °C with a minimum distance among relay of 5 mm
41.52	E81856	8 A – 277 Vac (GU-R) 8 A – 30 Vdc (GU; NO)		½ Hp (277 V) (4.1 FLA)	B300	Yes	2 or 3	40 or 70 °C with a minimum distance among relay of 5 mm
43.41	E81856	10 A – 250 Vac (GU-R) 4 A – 30 Vdc (R)	¼ Hp (5.8 FLA)	½ Hp (4.9 FLA)	B300 – R300	Yes	2 or 3	40 or 85 °C
43.61	E81856	10 A – 250 Vac (GU-R) (AgCdO) 16 A – 250 Vac (GU) (AgNi) 16 A – 250 Vac (R) (AgCdO)	¼ Hp (5.8 FLA) (AgCdO) 1/3 Hp (7.2 FLA) (AgNi)	½ Hp (4.9 FLA) (AgCdO) ¾ Hp (6.9 FLA) (AgNi)	B300 – R300	Yes	2 or 3	40 or 85 °C
44.52	E81856	6 A – 277 Vac (R)	1/8 Hp (3.8 FLA)	1/3 Hp (3.6 FLA)	/	Yes	/	85°C
44.62	E81856	10 A – 277 Vac (R)	¼ Hp (5.8 FLA)	¾ Hp (6.9 FLA)	/	Yes	/	85°C
45.31	E81856	16 A – 277 Vac (GU)(AgNi) 16 A – 30 Vdc (GU)(AgNi)	1/3 Hp (7.2 FLA) (AgNi; NO)	1 Hp (8 FLA) (AgNi)	/	Yes	2 or 3	105 or 125 °C with a minimum distance among relay of 10 mm
45.71	E81856	16 A – 240 Vac (GU) 16 A – 30 Vdc (GU) (AgCdO) 16 A – 277 Vac (GU) 16 A – 30 Vdc (NO-GU) 12 A – 30 Vdc (NC-GU) (AgNi)	½ Hp (9.8 FLA) (AgCdO) 1/3 Hp (7.2 FLA) (AgNi; NO)	1 Hp (8 FLA) (AgNi)	/	Yes	2 or 3	105 or 125 °C with a minimum distance among relay of 10 mm
45.91	E81856	16 A – 277 Vac (GU)(AgNi) 16 A – 30 Vdc (GU)(AgNi)	1/6 Hp (4.4 FLA)	½ Hp (4.9 FLA)	/	Yes	2 or 3	105 or 125 °C with a minimum distance among relay of 10 mm
46.52	E81856	8 A – 277 Vac (GU) 6 A – 30 Vdc (R)	¼ Hp (5.8 FLA/34.8 LRA)	½ Hp (4.9 FLA/29.4 LRA)	B300 – R300	Yes	2 or 3	70 °C
46.61	E81856	16 A – 277 Vac 12 A(NO)-10 A (NC) 30 Vdc (AgNi) 10 A(NO)-8 A(NC) 30 Vdc (AgSnO <sub>2</sub> )	1/3 Hp (7.2 FLA/43.2 LRA)	¾ Hp (6.9 FLA/41.4 LRA)	B300 – R300 (AgNi) A300 – R300 (AgSnO <sub>2</sub> )	Yes	2 or 3	70 °C

**TABLE 2.1** **US Certified products ratings**

R = Resistive / GP = General Purpose / GU = General Use / SB = Standard Ballast / I = Inductive (cosφ 0.4) / B = Ballast / NO = N.O. type

Type	UL file No.	Ratings			Open Type Devices	Pollution degree	Max Surrounding Air Temperature	
		AC/DC	"Motor Load" Single phase					
			110-120	220-240				
50	E81856	8 A – 277 Vac (GU) 8 A – 30 Vdc (GU)	1/3 Hp (7.2 FLA/43.2 LRA) (Only NO)	1/2 Hp (4.9 FLA/29.4 LRA) (Only NO)	B300 (NO only)	Yes	2 or 3	70 °C with a minimum distance among relay of 5 mm
55.X2 – 55.X3	E106390	10 A – 277 Vac (R) 10 A – 24 Vdc (R) (55.X2) 5 A – 24 Vdc (R) (55.X3)	1/3 Hp (7.2 FLA)	3/4 Hp (6.9 FLA)	R300 (2 CO only)	Yes	/	40 °C
55.X4	E106390	7 A – 277 Vac (GP) 7 A – 30 Vdc (GP) (Std/Au contact) 5 A – 277 Vac (R) 5 A – 24 Vdc (R) (AgCdO contact)	1/8 Hp (3.8 FLA)	1/3 Hp (3.6 FLA)	R300	Yes	/	55 °C
56	E81856	12 A – 277 Vac (GU) 12 A – 30 Vdc (GU) (AgNi; NO) 8 A – 30 Vdc (GU) (AgNi; NC) 12 A – 30 Vdc (GU) (AgCdO) 10 A – 30 Vdc (GU) (AgSnO <sub>2</sub> ; NO) 8 A – 30 Vdc (GU) (AgSnO <sub>2</sub> ; NC)	1/2 Hp (9.8 FLA)	1 Hp (8 FLA)	B300	Yes	2 or 3	40 or 70 °C
60	E81856	10 A – 277 Vac (R) 10 A – 30 Vdc (GU)	1/3 Hp (7.2 FLA)	1 Hp (8 FLA)	B300 (AgNi only) R300	Yes	/	40 °C
62	E81856	15 A – 277 Vac (GU) 10 A – 400 Vac (GU) 8 A – 480 Vac (GU) 15 A – 30 Vdc (GU)	3/4 Hp (13.8 FLA)	2 Hp (12 FLA) 1 Hp (480 Vac - 3 Ø) (2.1 FLA) (NO)	B300 (AgCdO) R300	Yes	2 or 3	40 or 70 °C
62.XX.9.XXX.X2XXS	E81856	16 A – 277 Vac (GU) 16 A – 30 Vdc (GU) 1.6 A – 110 Vdc (GU)	/	/	/	Yes	2 or 3	85 °C
62.31.9.XXX.4800	E81856	12 A – 240 Vdc (GU) 16 A – 125 Vdc (GU) 16 A – 30 Vdc (GU)	/	/	/	Yes	2 or 3	70 °C
62.32.9.XXX.4800	E81856	6 A – 240 Vdc (GU) 12 A – 125 Vdc (GU) 16 A – 30 Vdc (GU)	/	/	/	Yes	2 or 3	70 °C
65.31 65.61	E81856	20 A – 277 Vac (GU)	3/4 Hp (13.6 FLA)	2 Hp (12.0 FLA)	/	Yes	/	70 °C
65.31 NO 65.61 NO		30 A – 277 Vac (GU)						
65.31-S 65.61-S (DC coil and NO type only)		35 A – 277 Vac (GU)	/	/				
66	E81856	30 A – 277 Vac (GU) (NO) 10 A – 277 Vac (GU) (NC) 24 A – 30 Vdc (GU) (NO) 30 A – 30 Vdc (GU) (X6XX type only)	1 Hp (16.0 FLA/96 LRA) (AgCdO, NO only) 1/2 Hp (9.8 FLA/58.8 LRA) (AgNi, NO only)	2 Hp (12.0 FLA/72 LRA) (NO only)	/	Yes	2 or 3	70 °C with a minimum distance among relay of 20 mm
67	E81856	50 A – 277 Vac (GU) 50 A – 480 Vac (GU) (three phases)	/	/	/	Yes	3	85 °C (60 °C – x50x)
67 1301-1501	E81856	50 A – 277 Vac (GU) 50 A – 480 Vac (GU) (three phases)	1 1/2 Hp (20 FLA/120 LRA)	3 Hp (17 FLA/102 LRA) 15 Hp – 480 Vac – 3 Ø (21 FLA/116 LRA)	/	Yes	3	60°C (GU) or 40 °C
67 4301-4501	E81856	50 A – 277 Vac (GU) 50 A – 480 Vac (GU) (three phases)	1 1/2 Hp (20 FLA/120 LRA)	3 Hp (17 FLA/102 LRA) 10 Hp – 480 Vac – 3 Ø (14 FLA/81 LRA)	/	Yes	3	60°C (GU) or 40 °C
20	E81856	16 A – 277 Vac (R) 1000 W Tung. 120 V 2000 W Tung. 277 V	1/2 Hp (9.8 FLA)	/	/	Yes	/	40 °C
85.02 – 85.03	E106390	10 A – 277 Vac (R) 10 A – 24 Vdc (R) (55.X2) 5 A – 24 Vdc (R) (55.X3)	1/3 Hp (7.2 FLA)	3/4 Hp (6.9 FLA)	R300 (2 CO only)	Yes	/	40 °C
85.04	E106390	7 A – 277 Vac (GP) 7 A – 30 Vdc (GP) (Std/Au contact) 5 A – 277 Vac (R) 5 A – 24 Vdc (R) (AgCdO contact)	1/8 Hp (3.8 FLA)	1/3 Hp (3.6 FLA)	R300	Yes	/	55 °C
86	E106390	/	/	/	/	Yes	2	35 or 50 °C
99	E106390	/	/	/	/	Yes	2 or 3	50 °C
7T.81...2301 7T.81...2401	E337851	10 A – 250 Vac (R)		1 1/2 Hp (250 Vac) (10 FLA)	/	Yes	2	-20 / +40 °C
7T.81...2303 7T.81...2403	E337851	10 A – 250 Vac (R)		1 1/2 Hp (250 Vac) (10 FLA)	/	Yes	2	0 / +60 °C

**TABLE 2.2** **US Certified products ratings**

R = Resistive / GP = General Purpose / GU = General Use / SB = Standard Ballast / I = Inductive (cosφ 0.4) / B = Ballast / NO = N.O. type

Type	UL file No.	Ratings			Open Type Devices	Pollution degree	Max Surrounding Air Temperature	
		AC/DC	"Motor Load" Single phase					
			110-120	220-240				
19.21	E81856	10 A – 250 Vac (GU)	¼ Hp	½ Hp	B300 – R300	Yes	50 °C	
22.32 – 22.34	E81856	25 – 277 Vac (GU) 25 A – 30 Vdc (GU) 20 A – 277 Vac (B)	3/4 Hp (13.8 FLA / 82.8 LRA) (AgNi ; N.O.) 1/2 Hp (9.8 FLA / 5.8 LRA) (AgSnO <sub>2</sub> ; N.O.)	2 Hp (12 FLA / 72 LRA) (AgNi ; N.O.) 1.5 Hp (10 FLA / 60 LRA) (AgSnO <sub>2</sub> ; N.O.) Three phase (22.34 N.O. only) 3 Hp (9.6 FLA / 64 LRA)	A300	Yes	2	50 °C
0.22.33 – 0.22.35	E81856	5 A – 277 Vac (GU)			B300	Yes	2	50 °C
70.61	E106390	6 A – 250 Vac (R) 6 A – 24 Vdc (R)	/	/	/	Yes	2	50 °C
72.01 – 72.11	E81856	15 A – 250 Vac (R)	/	½ Hp (250 Vac) (4.9 FLA)	/	Yes	2 or 3	50 °C
77.01.0-8	E359047	5 A – 240 Vac (GU) 3 A – 277 Vac (SB)	1/10 Hp			Yes	2	50 °C
77.01.9.024.9024	E359047	12 A – 24 Vdc (GU)	5 A FLA/50 A LRA 24 Vdc			Yes	2	50 °C
77.01.9.024.9125	E359047	6 A – 120 Vdc (GU)	1/6 Hp - 120 Vdc			Yes	2	50 °C
77.11	E359047	15 A – 277 Vac (GU-B)	¾ Hp	1 Hp	/	Yes	2	45 °C
77.31	E359047	30 A – 400 Vac (GU) 30 A – 277 Vac (B)	¾ Hp	1 Hp ½ Hp (480 Vac)	/	Yes	2	40 °C
80.01-11-21-41-51-91...X(0 or P)XXX	E172124	10 A – 250 (R)		¾ Hp (250 Vac) (NO only)	B300 (NO only)	Yes	2	40 °C
80.61	E172124	8 A – 250 (GU;R)	/	1/3 Hp (250 Vac) (3.6 FLA)	R300	Yes	2	40 °C
80.82	E172124	6 A – 250 Vac (GU;R)	/	/	B300 – R300	Yes	2	40 °C
83.X1 – 83.X2	E81856	12 A – 250 Vac (GU)	/	/	/	Yes	2	50 °C
83.62	E81856	8 A – 250 Vac (GU)	/	/	/	Yes	2	50 °C
84	E81856	10A – 277 Vac 10 A – 30 Vdc	1/3 Hp (7.2 FLA/43.2 LRA)	¾ Hp (6.9 FLA/41.4 LRA)	B300 (NO only)	Yes	2	50 °C
75	E172124	6 A – 250 Vac (GU same polarity) 6 A – 24 Vdc (GU)	/	/	B300 (NO only)	Yes	/	70 °C
75.23	E172124	10 A – 250 Vac (GU same polarity) 6 A – 24 Vdc (GU)	/	/	B300 (NO only)	Yes	/	70 °C
78.1D – 78.1C	E361251	5 A – 24 Vdc (120 W)	/	/	/	Yes	2	40 °C
78.1B	E361251	4.5 A – 24 Vdc (108 W)	/	/	/	Yes	2	40 °C
78.2E	E361251	10 A – 24 Vdc (240 W)	/	/	/	Yes	2	40 °C

**Capacitor start motors**

Single phase 230 V AC capacitor start motors have a starting current of about 120% of the rated current. However, damaging currents can result from an instantaneous reversal of the direction of rotation. In the first diagram, high circulating currents can cause severe arcing across the contact gap, as the changeover contacts make an almost instantaneous reversal of polarity to the capacitor. Measurements have shown a peak current of 250 A for a 50 Watt motor, and up to 900 A for a 500 Watt motor. This inevitably leads to welding of the contacts.

Reversing the direction of such motors should therefore use two relays, as the second diagram shows, whereby in the control to the relay coils a "dead break" of approximately 300 ms is provided. The delay can either be provided by another control component such as a Timer, or through the Microprocessor etc., or by connecting a suitable NTC resistance in series with each relay coil. Cross interlocking the coil circuits of both relays will not produce the required delay! Moreover, the use of anti-weld contact material will not solve the problem.

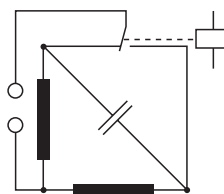

**Incorrect AC motor reversal:**

Contact is in the intermediate state for less than 10 ms – insufficient time to allow the energy in the capacitor to dissipate before the electrical connection is remade to the opposite polarity.

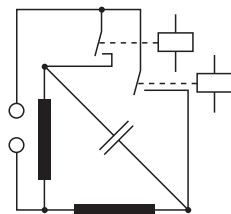

**Correct AC motor reversal:**

Provision of 300 ms "dead break" time when neither relay contacts are closed - during which time the capacitor discharges harmlessly through the motor windings.



**TABLE 2.3** **Certified sockets ratings**

Socket type	UL ratings	CSA ratings	Open Type Devices	Pollution degree (Installation environment)	Max Surrounding Air Temperature	System Overvoltage Category (max peak Voltage impulse)	Conductors to be used	Wire size (AWG)	Terminal tightening torque
90.02/03	10A-300V(60°C) 8A-300V(70°C)	10A 300V (max 20A Total Load)			70°C				
90.14/15	10A 300V	10A 300V max20A TL							
90.20/21/26/27	10A 300V	10A 250V							
90.82.3	10A 300V	10A 300V			70 °C			14-20 stranded and solid	7.08 lb.in. (0.8 Nm)
90.83.3	10A 300V	10A 300V			65 °C			14-20 stranded and solid	7.08 lb.in. (0.8 Nm)
92.03	16A 300V	10A 250V (max 20A Total Load)			70°C		75°C Cu only	10-24, stranded or solid	7.08 lb.in. (0.8 Nm)
92.13/33	16A 300V	10A 300V max20A TL							
93.01/51	6A 300V	6A 250V			60°C		75°C Cu only	14-24, stranded or solid	
93.02/52	2x10A 300V (60°C) 2x8A 300V (70°C)	2x10A 300V (60°C) 2x8A 300V (70°C)	Yes	2	60 or 70°C	II (2.5 kV)	75°C Cu only (CSA)		
93.11	6A 300V	6A 300V			70°C				
93.21	6A 300V	/	Yes	2	70°C				
93.60/65/ 66/67/69	6A 300V (40°C) 4A 300V (70°C)	6A 300V (40°C) 4A 300V (70°C)			40 or 70°C		75°C Cu only	14-24, stranded or solid	
93.61/62/ 63/64/68	6A 300V (40°C) 4A 300V (70°C)	6A 300V (40°C) 4A 300V (70°C)			40 or 70°C		75°C Cu only	14-24, stranded or solid	4.43 lb.in. (0.5 Nm)
09368141	100mA 24V	100mA 24V			70°C				
94.02/03/04	10A 300V	10A 250V (max 20A Total Load)			70°C		75°C Cu only	10-24 stranded, 12-24 solid	4.43 lb.in. (0.5 Nm)
94.12/13/14	10A 300V (4 pole: 5A 300V)	10A 300V max20A TL							
94.22/23/24	10A 300V	10A 250V							
94.33/34	10A 300V (4 pole: 5A 300V)	10A 300V max20A TL							
94.54	10A 300V		Yes		70 °C		Copper only	14-18-24 stranded and solid	
94.62/64	10A 300V	10A 250V							
94.72/73/74	10A 300V	10A 250V (94.74: max 20A Total Load)							
94.82	10A 300V	10A 250V							
94.82.3/92.3	10A 300V		Yes		70 °C				
94.84.3/94.3	10A 300V		Yes		55 °C				
94.82.2	10A 300V		Yes		50 °C				
94.84.2	7 A 300 V		Yes		50 °C				
94.P2/P3	10A 300V	10A 300V	Yes		70°C			14-26 stranded and solid	
94.P4	7A 300V	7A 300V	Yes		70°C			14-26 stranded and solid	
95.03/05	10A 300V	10A 250V (max 20A Total Load)			70°C		75°C Cu only	10-24 stranded, 12-24 solid	4.43 lb.in. (0.5 Nm)
95.13.2	12A 300V	10A 300V (max 20A Total Load)	Yes		70 °C with a minimum distance of 5 mm				
95.15.2	10A 300V	10A 300V (max 20A Total Load)	Yes		70 °C with a minimum distance of 5 mm				
95.55/55.3	10A 300V (40°C) 8A 300V (70°C)	10A 300V (40 °C) 8A 300V (70 °C)	Yes		40 or 70°C			14-24 stranded and solid	
95.23	10A 300V	10A 250V							
95.63/65	10A 300V	10A 250V							
95.75	10A 300V	10A 250V (max 20A TL)							
95.83.3/85.3/ 93.3/95.3	12A 300V		Yes		85 °C			14-18, stranded or solid	7.08 lb. in. (0.8 Nm)
95.P3/P5	10A 300V	10A 300V	Yes		70°C			14-26 stranded and solid	
96.02/04	12A 300V (50°C) 10A 300V (70°C)	12A 300V (50°C) 10A 300V (70°C)	Yes		50 or 70°C	III (4.0 kV)	60/75°C Cu only 75°C Cu only (CSA)	10-14, stranded or solid	7.08 lb.in. (0.8 Nm)
96.12/14	12A 300V	15A 250V							
96.72	16A 300V	10A 250V (max 20A Total Load)							
96.74	15A 300V	10A 250V (max 20A Total Load)							
97.01	16A 300V (50°C) 12A 300V (70°C)	16A 300V (50°C) 12A 300V (70°C)	Yes		50 or 70°C		75°C Cu only (CSA)		
97.02	2x8A 300V	2x8A 300V	Yes		70°C		75°C Cu only (CSA)		
97.11	16A 300V (50°C) 12A 300V (70°C)	/	Yes		50 or 70 °C with a minimum distance of 5 mm				
97.12	2x8A 300V	/	Yes		70 °C with a minimum distance of 5 mm				
97.51 - 97.51.3	15A 300V (40°C) (2-wires/per pole) 10A 300V (70°C)	15A 300V (40 °C) 10A 300V (70 °C)	Yes		40 or 70°C			14-24 stranded and solid	
97.52 - 97.52.3	10A 300V (40°C) 8A 300V (70°C)	8A 300V	Yes		70°C			14-24 stranded and solid	
97.P1/P2	10A 300V	10A 300V	Yes		70°C			14-26 stranded and solid	

**Three-phase alternating current loads**

Larger three-phase alternating current loads should preferably be switched with contactors according to EN 60947-4-1 Electromechanical contactors and motor starters. Contactors are similar to relays but they have their own characteristics; typically compared to relays:

- They can normally switch different phases at the same time.
- They are physically much larger.
- Their design and construction usually features double break contacts.
- They can withstand certain short-circuit conditions.

There is nevertheless, some overlap between relays and contactors regarding switching characteristics and applications.

However, when switching three-phase alternating current with relays, consider and take into account:

- The isolation co-ordination, i.e. the voltage stress and the degree of pollution between the contacts according to the insulation rated voltage.
- And, avoid the use of the NO relay versions with 3 mm contact gaps, unless the isolation afforded by the contact gap is specifically required.

**Three-phase motors**

Higher power three-phase motors are often switched by a 3-pole contactor, where there is high isolation/separation between phases. However, for space, size and other reasons, relays are also called upon to switch 3-phase motors.

**TABLE 3 Motor ratings v relay series**

Relay series	Motor Power (400 V 3 phase)		Permissible degree of pollution	Impulse voltage
	kW	PS(hp)		
55.33, 55.13	0.37	0.50	2	4
56.34, 56.44	0.80	1.10	2	4
60.13, 60.63	0.80	1.10	2	3.6
62.23, 62.33, 62.83	1.50	2.00	3	4
67.23	11	15	3	6

62 series relay is also capable to switch 1 hp 480 V 3 phase motors

**Reversing the motor:** Take particular care if it is required to change the motor direction by reversing two of the supply phases applied to the motor terminals, as this will result in severe damage unless there is a "dead time" between the changeover. Therefore, use one relay for the forward direction and another for the reverse direction (as the following diagram). And, most importantly, ensure that there is a "dead time" of no less than 50 ms - when neither relay coil is energised. Simple cross interlocking of the relay coils will not produce a Time delay! However, choosing a tougher, anti-weld contact material may further improve the reliability and performance, and is advised.

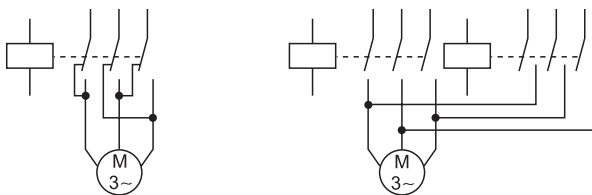

**Incorrect three-phase motor reversal:** The electrical stress of opposing phase voltages across the contact gap, together with contact arcing can result in a phase to phase short-circuit.

**Correct three-phase motor reversal:** "Dead break" time of > 50 ms, during which time neither the Forward nor the Reverse relay contacts are closed.

Notes:

- 1 - For AC3 category (starting and switching off) - motor reversal is only permitted if there is a guaranteed break of 50 ms between energisation in one direction and energisation in the other. Observe the maximum starts per hour, according to the motor manufacturer's recommendation.
- 2 - AC4 category (starting, plugging, reversing and inching/jogging) is not possible with relays or small contactors. In particular, the direct reversing of phase connections for "plugging" will result in severe contact arcing leading to a short-circuit within the relay or contactor.
- 3 - Under certain circumstances it may be preferable to use three single pole relays to control each phase individually, and so achieve greater separation between the phases. (Any relatively small time difference between the operation times of the three relays is insignificant compared to the much slower operation of contactors.)

**Switching different voltages within a relay**

Switching different voltages in a relay e.g. 230 V AC with one contact and 24V DC with a neighboring contact is possible - provided that the Insulation type between adjacent contacts is at least of Basic level. However, note that the equipment standard might demand a higher level that is not possible using adjacent contacts on the same relay. The possibility of using more than one relay could be considered.

**Contact resistance**

Measured, according to Application Category (Table 4), at the external terminals of the relay. It is a final test value, not necessarily reproducible subsequently. It has little effect on relay reliability for most applications since a typical value would be < 50 mΩ (measured with 24 V 100 mA).

**Contact categories according to EN 61810-7**

The effectiveness with which a relay contact can make an electrical circuit depends on several factors, such as the material used for the contact, its exposure to environmental pollution and its design etc. Therefore, for reliable operation, it is necessary to specify a Contact Category, which is defined in terms of the characteristics of the load. The appropriate Contact Category will also define the voltage and current levels used to measure the contact resistance. All Finder relays are category CC2.

**TABLE 4 Contact categories**

Contact category	Load characteristic	Contact Resistance Measurement	
		30 mV	10 mA
CC0	Dry circuit	30 mV	10 mA
CC1	Low load without arcing	10 V	100 mA
CC2	High load with arcing	30 V	1 A

**TABLE 5 Contact materials characteristics**

Material	Property	Typical application
AgNi + Au (Silver Nickel Gold plated)	- Silver-nickel base with a galvanic hard gold plating - Gold is not attacked by industrial atmospheres - With small loads, contact resistance is lower and more consistent compared to other materials. <b>NOTE:</b> hard gold plating is completely different to 0.2 μm gold flashing, which allows only protection in storing, but no better performance in use.	Wide range applications: - Small load range (where gold plating erodes very little) from 50 mW (5 V - 2 mA) up to 1.5 W/24 V (resistive load). - Middle load range where gold plating erodes after several operations and the property of basic AgNi becomes dominant. <b>NOTE:</b> for switching lower load, typically 1 mW (0.1 V - 1 mA), (for example in measuring instruments), it is recommended to connect 2 contacts in parallel.
AgNi (Silver Nickel)	- Standard contact material for most relay applications - High wear resistance - Medium resistance to welding	- Resistive and slightly inductive loads
AgCdO (Silver Cadmium Oxide)	- High wear resistance with higher AC loads - Good resistance to welding	- Inductive and motor loads
AgSnO <sub>2</sub> (Silver Tin Oxide)	- Excellent resistance to welding	- Lamp and capacitive loads - Very high Inrush current loads



## Coil specification

### Nominal voltage

The nominal value of coil voltage for which the relay has been designed, and for which operation is intended. The operating and performance characteristics are with respect to the coil at nominal voltage.

### Rated power

The DC power value (W) or the apparent AC power value (VA with closed armature) which is absorbed by the coil at 23 °C and at rated voltage.

### Operating range

The range of input voltage, in nominal voltage applications, in which the relay works in the whole range of ambient temperatures, according to operating class:

- class 1: (0.8...1.1)U<sub>N</sub>
- class 2: (0.85...1.1)U<sub>N</sub>

In application where the coil voltage doesn't meet the tolerances of nominal voltage, the diagrams "R" shows the relation of maximum coil voltage permitted and pick-up voltage (without pre-energisation) versus ambient temperature.

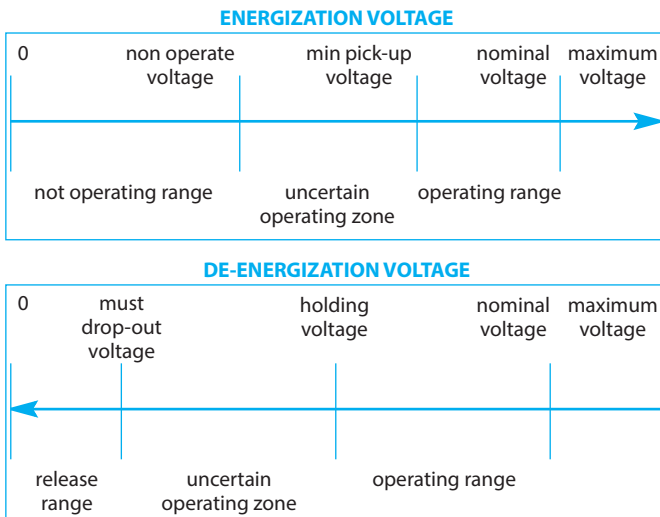

### Non-operate voltage

The highest value of input voltage at which the relay will not operate (not specified in the catalogue).

### Minimum Pick-up voltage (Operate voltage)

The lowest value of applied voltage at which the relay will operate.

### Maximum permitted voltage

The highest applied coil voltage that the relay can continuously withstand, dependent on ambient temperature (see "R" diagrams).

### Holding voltage (Non-release voltage)

The lowest value of coil voltage at which the relay (which has previously been energised with a voltage within the operating range) will not drop-out.

### Must drop-out voltage (Must release voltage)

The highest value of coil voltage at which the relay (having previously been energised with a voltage within the operating range) will definitely drop-out. The same "per unit" value can be applied to the nominal coil current value to give an indication of the maximum leakage current that may be permitted in the coil circuit, before problems with relay release might be expected.

### Coil Resistance

The nominal value of the coil resistance under the standard prescribed condition of 23 °C ambient. Tolerance is ± 10%.

### Rated coil consumption

The nominal value of coil current, when energized at nominal voltage (and at 50 Hz for AC coils).

### Thermal tests

Calculation of the coil temperature rise ( $\Delta T$ ) is made by measuring the coil resistance in a temperature controlled oven (not ventilated) until a stable value is reached (no less than 0.5 K variation in 10 minutes).

$$\text{That is: } \Delta T = (R2 - R1)/R1 \times (234.5 + t1) - (t2 - t1)$$

where:

- R1 = initial resistance
- R2 = final resistance
- t1 = initial temperature
- t2 = final temperature

### Monostable relay

An electrical relay which, having responded to coil energisation by changing contact state, returns to the previous contact state when the coil energisation is removed.

### Bistable relay

An electrical relay, which, having responded to coil energisation by changing contact state, retains that contact state after the coil energisation has been removed. A further energisation of the coil is necessary to cause the contact state to revert.

### Latching relay

A bistable relay, where the contacts retain their state due to a mechanical latching mechanism. Subsequent applications of coil energisation causes the contacts to "toggle" open and closed.

### Remanence relay

A bistable relay, where the contacts retain their operated (or Set) state due to remanent magnetism in the relay iron circuit caused by the application of a DC current through the coil. Resetting the contact state is achieved by passing a smaller DC current through the coil in the opposite direction. For AC excitation, magnetization takes place via a diode to produce a DC set current, and demagnetising is achieved by applying an AC coil current of lower magnitude.

## Insulation

### Relay function and isolation

One of the main functions of a relay is to connect and disconnect different electric circuits, and usually, to maintain a high level of electrical separation between the various circuits. It is therefore necessary to consider the level of isolation appropriate to the application and the task to be performed - and to relate this to the relay's specification. In the case of electromechanical relays the areas of isolation generally considered are:

- Isolation between coil and all contacts (the "contact set").  
Catalogue data - "Insulation between coil and contact set".
- Isolation between physically adjacent, but electrically separate, contacts of a multi-pole relay. Catalogue data - "Insulation between adjacent contacts".
- Isolation between the open contacts (applies to the NO contact, and the NC contact when the coil is energised).  
Catalogue data - "Insulation between open contacts".

### Specifying isolation levels

There are several ways of specifying or describing the level of isolation offered by, or demanded of, a relay. These include:

Insulation coordination, which focuses on the levels of impulse voltage likely to be seen on the supply lines of the application equipment and the cleanliness of the immediate surroundings of the relay in the equipment. And, as a consequence, it demands appropriate levels of separation between circuits, in terms of isolating distances and quality of insulating material used etc. (see additional information under "Insulation coordination").

Type of insulation; For both equipment and components such as a relay, there are several types (or levels) of insulation that might be demanded between the various circuits. The appropriate type will depend on the specific function being performed, the voltage levels involved, and the associated safety consequences. The various types of insulation are listed below, and those appropriate to each relay series are stated within the relay data; Specifically, within the table under the section entitled **Technical data**, sub-heading; Insulation.

**Functional insulation;** Insulation between conductive parts, which is necessary only for the proper functioning of the relay.

**Basic insulation;** Insulation applied to live parts to provide basic protection against electric shock.

**Supplementary insulation;** Independent insulation applied in addition to basic insulation, in order to provide protection against electric shock in the event of a failure of basic insulation.

**Double insulation;** Insulation comprising both basic insulation and supplementary insulation.

**Reinforced insulation;** A single insulation system applied to live parts, which provides a degree of protection against electric shock equivalent to double insulation.

(Usually, the decision as to the appropriate type of insulation will have already been made by the equipment standard.)

**Dielectric strength, and high voltage impulse tests;** These are either, final inspection or Type tests, which prove the level of isolation in terms of the minimum voltage stress that can be withstood, between the various specified electrical circuits. As the only method of specifying and checking for adequate isolation, this tends to be the more historical approach. However, there are still some dielectric strength requirements to be found within both the Insulation coordination approach and the Level of Insulation approach.

**Insulation coordination**

In accordance with EN 61810-1 and IEC 60664-1, the Insulation characteristics offered by a relay can be described by just two characteristic parameters – the **Rated Impulse Voltage** and the **Pollution Degree**.

To ensure the correct Insulation Coordination between the relay and the application, the equipment designer (relay user) should establish the **Rated Impulse Voltage** appropriate to his application, and the **Pollution Degree** for the microenvironment in which the relay is situated. He should then match (or coordinate) these two figures with the corresponding values given in the appropriate relay data, under the section entitled **Technical data**, sub-heading; Insulation.

**Rated Impulse Voltage;** To establish the appropriate Rated Impulse Voltage refer to the appropriate Equipment Standard which may specify mandatory values for equipment being designed. Alternatively, using the Rated Impulse Voltage table (Table 6) with knowledge of the Nominal Voltage of the Supply System and knowledge of the Overvoltage Category, determine the appropriate Rated Impulse Voltage.

**Overvoltage Category;** this is described in IEC 60664-1, but is also summarised in the footnotes to Rated Impulse Voltage table. Alternatively, it may be specified in the equipment standard.

**Pollution Degree;** determine this by considering the immediate surroundings of the relay (refer to Pollution Degree table 7). Then check that the relay specification offers the appropriate (or better) Rated Impulse Voltage and Rated Insulation Voltage, for that Pollution Degree.

**Nominal voltage of supply system**

This effectively describes the source of the power supply system, so 230/400 V AC indicates that this would be (or is likely to be) a three-phase sub-station transformer with a Neutral connection. Being aware of the source of the supply system is important since (in conjunction with the Overvoltage category) it determines the typical levels of impulse voltage likely to be seen on the supply lines, and this has to be taken into account in the designing of the relay. However, it does not necessarily follow that the relay will be rated by the manufacturer for use at the highest voltage of the supply system. It is the declared Rated Insulation Voltage that confirms this aspect.

**Rated Insulation Voltage**

This is a notional value of voltage that indicates the relay's insulation as being suitable for handling voltages up to this level. Note that this notional Rated Insulation Voltage is selected from a list of preferred values. For Finder relays, 250 V and 400 V are two such preferred values, and of course they will cover respectively, the 230 V L-N and 400 V L-L voltages commonly encountered in practice.

**TABLE 6 Rated impulse voltage**

Nominal voltage of the supply system <sup>(1)</sup> V		Rated insulation voltage V	Rated impulse voltage kV			
Three-phase systems	Single-phase systems		Overvoltage category			
			I	II	III	IV
	120 to 240	125 to 250	0.8	1.5	2.5	4
230/400		250/400	1.5	2.5	4	6
277/480		320/500	1.5	2.5	4	6

(1) In accordance with IEC 60038.

Remark: The descriptions of overvoltage categories below are for information. The actual overvoltage category to be considered has to be taken from the product standard defining the application of the relay.

**Overvoltage category I** Applies to equipment intended for connection to fixed installations of buildings, but where measures have been taken (either in the fixed installation or in the equipment) to limit transient overvoltages to the level indicated.

**Overvoltage category II** Applies to equipment intended for connection to fixed installations of buildings.

**Overvoltage category III** Applies to equipment in fixed installations, and for cases where a higher degree of availability of the equipment is expected.

**Overvoltage category IV** Applies to equipment intended for use at or near the origin of the installation, from the main distributor towards the supply mains.

**TABLE 7 Pollution degree**

Pollution degree	Immediate surroundings of relay
1	No pollution or only dry, non-conductive pollution occurs. The pollution has no influence.
2	Only non-conductive pollution occurs, except that occasionally a temporary conductivity caused by condensation is to be expected.
3	Conductive pollution occurs or dry, non-conductive pollution occurs which becomes conductive due to condensation, which is to be expected.

Dependent on the product standard, pollution degree 2 and 3 are commonly prescribed for equipment. For example, EN 50178 (electronics for use in power installations) prescribes, under normal circumstances, contamination level 2.

**Dielectric strength**

This can be described in terms of an AC voltage test, or in terms of an Impulse (1.2/50 µs) voltage test. (The correspondence between the AC test and Impulse voltage test is listed in IEC 60664-1 Annex A, Table A.1).

All Finder relays receive a 100% final inspection AC (50 Hz) dielectric strength test; applied between all contacts and coil, between adjacent contacts, and across open contacts. The leakage current must be less than 3 mA.

For Type testing, both AC and Impulse voltage dielectric strength tests are applied.

**Insulation Group**

This was the older Insulation Group classification (such as C 250), which was according to the VDE 0110 standard. They have largely been replaced with the more recent way of specifying insulation properties, according to Insulation Coordination.

**SELV, PELV and Safe separation**

Insulation Coordination as described earlier ensures the isolation of hazardous voltages from other circuits to a safe engineering level, but may not be adequate on its own if the design of the equipment permits the LV circuit to be accessible and therefore able to be touched directly or, where the nature and location of the electricians presents extra dangers.

Therefore, for these extra dangerous applications (such as swimming pool lighting or bathroom electricians) there can be a need for a special low voltage supply system (SELV or PELV), that is inherently safe and highly secure, working at low voltage and with much higher levels of physical isolation and integrity between it and other hazardous circuits.

**The SELV system**

The SELV system (Separated Extra Low Voltage) is achieved by designing with double or reinforced insulation and by ensuring "safe separation" from hazardous circuits in accordance with regulations for SELV circuits. The SELV voltage (which is isolated from Ground) must be derived via a safety transformer meeting double or reinforced isolation between the windings, as well as other safety requirements demanded by the appropriate standard.

Note: The value for the "safe voltage" can differ slightly dependent upon the particular application or end product regulation.

There are specific requirements for keeping SELV circuits and wiring separate from other hazardous circuits, and it is this aspect concerning the separation of the coil to contacts that is met by several Finder relays as standard, and as a special version of the 62 series of relays - where an additional barrier is a special option.

**The PELV system**

The PELV system (Protected Extra Low Voltage), like the SELV system, requires a design that guarantees a low risk of accidental contact with a high voltage, but in contrast, it has a protective earth (ground) connection. Like SELV, the transformer can have windings separated by double or reinforced isolation, or by a conductive shield with a protected earth connection.

Consider a common situation, where the mains voltage of 230 V and a low voltage circuit both appear within a relay; all the following requirements must be met by the relay - and also applied to the connections/wiring to it.

- The low voltage and the 230 V must be separated by double or reinforced insulation. This means that between the two electrical circuits there must be guaranteed a dielectric strength of 6 kV (1.2/50 μs), an air distance of 5.5 mm and, depending on the pollution degree and on material used, an appropriate tracking distance.
- The electrical circuits within the relay must be protected against any possibility of bridging, caused for instance by a loose metal part. This is achieved by the physical separation of circuits into isolated chambers within the relay.
- The different voltage wiring connected to the relay must also be physically separated from each other. This is normally achieved by using separate cable channels.
- For relays mounted on printed circuit boards the appropriate distance between the tracks connected to low voltage and the tracks connected to other voltages must be achieved. Alternatively, earth barriers can be interposed between hazardous and safe parts of the circuitry.

Although this appears quite complex, with the SELV capability/options offered by some Finder relays, the user only needs to address the two last points. And, when using a socket where the coil and contact connections are on opposite sides, the separation of wiring into different cable channels is greatly facilitated.

**General technical data**

**Cycle**

The operate and subsequent release of a relay. Over a cycle, the coil is energised and de-energised, and a (NO) contact will have progressed through a cycle of making circuit, through to breaking the circuit, back to the point at which it is just about to re-make the circuit.

**Period**

The time taken by one cycle.

**Duty factor (DF)**

During cyclic operation, the Duty Factor is the ratio between the time the relay is energized, to the time taken for one cycle (i.e. the Period). For continuous duty, the DF = 1.

**Continuous operation**

This would represent the condition where the coil is permanently energized, or is energized for at least sufficient time for the relay to reach thermal equilibrium.

**Mechanical life**

This is derived from a test performed by energising the coils of several relays at 5 to 10 cycles per second without any load applied to the contacts. It establishes the ultimate durability of the relay where electrical wear of the contacts is not an issue. The maximum Electrical Life may therefore approach the Mechanical Life where the electrical loading of the contacts is very small.

**Operate time**

The typical time (average of values measured supplying the relay coil with the nominal DC voltage) for the NO contact to close, from the point of coil energisation. It does not include the bounce time (see following pattern).

**Release time**

- For CO relays: The typical time (average of values measured removing from the coil the DC voltage) for the NC contact to close, from the point of coil de-energisation. It does not include the bounce time.

- For NO relays: The typical time (average of values measured removing from the coil the DC voltage) for the NO contact to open, from the point of coil de-energisation.

Note: The release time will increase if a suppression diode in parallel with the coil is employed (either in the form of; a coil protection module; integrated option within the relay; or mounted directly on the PCB).

**Bounce time**

The typical time duration (average of values measured) while closing contacts bounce, before attaining a stable closed state. Different values generally apply to NO and NC contacts.

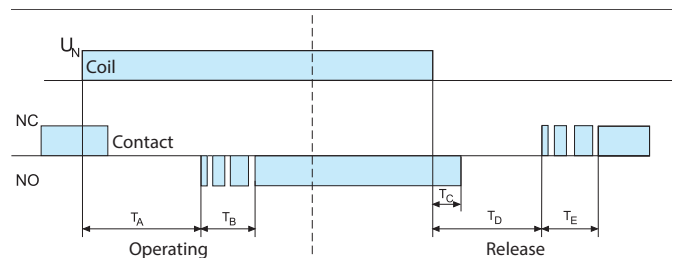

- T<sub>A</sub> Operate time
- T<sub>B</sub> Bounce time for NO contact
- T<sub>C</sub> Release Time (NO relays)
- T<sub>D</sub> Release Time (CO relays)
- T<sub>E</sub> Bounce time for NC contact

For each relay type, the catalogue data-sheet states the operate and release time on the main page, and the bounce times are shown in the "Technical data" section that follows the "Ordering information" section. All these values must be considered as "average" values, such that an individual relay can show times differing by about ± 3 ms from the stated value. For relays with AC coil such differences can reach 10 ms.

**Ambient temperature**

The temperature of the immediate area where the relay is located. It will not necessarily correspond to the ambient temperature either within, or external to, the enclosure in which the relay is located. To accurately measure the ambient temperature with respect to the relay, remove the relay from its location whilst maintaining the worst-case energisation of all the other relays and components within the enclosure or panel. Measuring the temperature at the position vacated by the relay will give the true ambient temperature in which the relay is working.

**Ambient temperature range**

The temperature range over which, operation of the relay is guaranteed (under prescribed conditions).

**Storage temperature range**

This can be taken as the ambient temperature range, with the upper and lower limits extended by 10 °C.

**Environmental protection**

According to EN 61810-1. The RT categories describe the degree of sealing of the relay case:

Environmental protection category	Protection	
RT 0	Unenclosed relay	Relay not provided with a protective case.
RT I	Dust protected relay	Relay provided with a case, which protects its mechanism from dust.
RT II	Flux proof relay	Relay capable of being automatically soldered without allowing the migration of solder fluxes beyond the intended.
RT III	Wash tight relay	Relay capable of being automatically soldered and subsequently undergoing a washing process to remove flux residues without allowing the ingress of flux or washing solvents.

**Special application categories**

RT IV	Sealed relay	Relay provided with a case which has no venting to the outside atmosphere.
RT V	Hermetically sealed relay	Sealed relay having an enhanced level of sealing.

**Protection category**

According to EN 60529. The first digit is related to the protection against the intrusion of solid foreign objects into the relay, and also against access to hazardous parts. The second digit relates to the protection against ingress of water. The IP category relates to the relay, when used normally in relay sockets or PC boards.

For sockets, IP 20 signifies that the socket is "finger-safe" (VDE 0106).

IP Examples:

IP 00 = Not protected.

IP 20 = Protected against solid foreign objects of 12.5 mm Ø and greater. Not protected against water.

IP 40 = Protected against solid foreign objects of 1 mm Ø and greater. Not protected against water.

IP 50 = Protected against powder (ingress of dust is not totally prevented, but dust shall not penetrate in a quantity to interfere with satisfactory operation of the relay). Not protected against water.

IP 51 = As IP 50, but with protection against vertically falling drops of water.

IP 54 = As IP 50, but with protection against sprayed from all directions - limited ingress permitted.

IP 67 = Totally protected against powder (dust-tight) and protected against the effects of temporary immersion in water.

**Vibration resistance**

The maximum level of sinusoidal vibration, over the specified frequency range, which can be applied to the relay in the X-axis without the opening (for more than 10 µs) of the NO contact (if the coil is energised) or NC contact (if the coil is not energised). (The X-axis is the axis through the plane of the relay face containing the relay terminals). The vibration resistance is usually higher in the energised state, than in the non-energised state. Data for other axes and frequency ranges, on request. The level of vibration is given in terms of the maximum acceleration of the sinusoidal vibration, "g" (where g = 9.81 m/s<sup>2</sup>). But note: the normal testing procedure according to

IEC 60068-2-6 prescribes to limit the maximum peak-to-peak displacement in the lower range of frequencies.

**Shock resistance**

The maximum mechanical shock (half-sine 11 ms waveform) permitted in the X-axis without contact opening > 10 µs.

Data for other axes on request.

**Installed orientation**

The component's specification is unaffected (unless expressly stated otherwise) by its orientation, (provided it is properly retained, eg by a retaining clip in the case of socket mounted relays.)

**Power lost to the environment**

The value of the power lost from the relay with the coil energised (without contact current, or with full rated current through all NO contacts). This may be used in the thermal design and regulation of the control panel.

**Recommended distance between relays mounted on printed circuit boards**

This is the minimum mounting distance suggested when several relays are mounted on the same PC board. Care and consideration shall be given to ensure that other components mounted on the PC board do not heat the relay and raise its microenvironment beyond the permitted maximum ambient temperature.

**Torque**

The maximum value of torque that can be used for tightening terminal screws, according to EN 60999, is 0.4 Nm for M2.5 screws, 0.5 Nm for M3 screws, 0.8 Nm for M3.5 screws, 1.2 Nm for M4 screws. The test torque is indicated in the catalogue. Normally a 20% increase of this value is acceptable.

Both slot-head and cross-head screwdrivers can be used.

**Minimum Wire size**

If not otherwise indicated, for screw terminals a minimum cross-section of 0.5 mm<sup>2</sup> is permitted.

**Max. wire size**

Maximum cross-section of cables (solid or stranded wire, without ferrules) that can be connected to each terminal. For use with ferrules, the wire cross-section has to be reduced (e.g. from 4 to 2.5 mm<sup>2</sup>, from 2.5 to 1.5 mm<sup>2</sup>, from 1.5 to 1 mm<sup>2</sup>).

**Terminating more than one wire**

EN 60204-1 permits 2 or more wires to be terminated in the same terminal. All Finder products are designed in such a way that each terminal can accept 2 or more wires, except screwless and push-in terminals.

**Box clamp**

Wires are terminated within a box shaped clamp. Effective retention of solid, stranded and "bootlace" wires, but not suitable for wires terminated with "fork" style terminations.

**Plate clamp**

Wires are terminated under the pressure of a clamp plate. Effective for "fork" terminated wires and solid wire, but less so for stranded wire.

**Screwless terminal (Spring clamp)**

Wires are terminated under the pressure of a spring clamp. The clamp being temporarily held open by the insertion of a tool, while the wire is inserted.

**Push-in terminal**

Similarly to spring clamp terminals, wires are terminated under the pressure of a spring clamp. Solid wires or ferrules can be quickly connected by their simple insertion into the terminal. For stranded wires insertion, and for each wire type extraction, it is necessary first to open the terminal by pushing down on the push-button.

**Jumper link**

Jumper links are accessories intended to simplify wiring and are typically used in the connection of the common side of multiple coils.

Attention must be paid to the total current that they can carry, if used to interconnect contact circuits, and to the stability of their mechanical and electrical connection (for example, their use is not recommended in applications where continuous vibration is expected).



## SSR - Solid State Relay

### SSR Solid State Relay

A relay utilising semiconductor technology, rather than electromechanical. In particular, the load is switched by a semiconductor and consequently these relays are not subject to burning of contacts and there is no migration of contact material.

SSRs are capable of very high speed switching and virtual unlimited life. However, SSRs for switching DC are polarity sensitive and consideration must be given to the maximum permitted blocking voltage.

### Opto-coupler

For all SSR relays in the catalogue, the electrical isolation between Input and Output circuits is provided by the use of an opto-coupler.

### Switching voltage range

The minimum to maximum range for the load voltage.

### Minimum switching current

The minimum value of load current necessary to ensure correct switch-on and switch-off action.

### Control current

The nominal value of input current, at 23 °C and with rated voltage applied.

### Maximum blocking voltage

The maximum level of output (load) voltage that the SSR can withstand.

## Relay with forcibly guided (mechanically linked) contacts, or safety relay

A relay with forcibly guided contacts is a special type of relay which must satisfy the requirements of a very specific safety EN standard.

Such relays are used within safety systems to guarantee their operational safety and reliability, contributing to a safe working environment.

Such relays must have at least one NO and one NC forcibly guided contact. These contacts must be mechanically linked, such that if one of the contacts fails to open, the other is prevented from closing (and vice versa). This requirement is fundamental in order to identify with certainty the non-correct operation of a circuit. For example, a failure of a NO contact to open (for example, by welding closed) is identified by the failure of the NC from closing, thereby signaling an operational anomaly. Under such circumstances, the standard requires a guaranteed contact gap of 0.5 mm to be maintained.

EN 61810-3 (which replaced former EN 50205) is the standard that establishes the requirements for relays with forcibly guided contacts, and it describes two types:

- Type A: where all the contacts are forcibly guided
- Type B: where only some contacts are forcibly guided

According to EN 61810-3, in a relay with changeover contacts, only the NO of one pole and the NC of the other pole can be considered as forcibly guided contacts. In the case of the 50.12 type relay this means the remaining poles cannot be considered as forcibly guided and therefore this relay is categorised as "Type B".

However, since the other 50 series relay types and all the relays of 7S series offer only NO and NC contacts, they can be categorized as "Type A".

## Monitoring and Measuring relays

### Supply voltage monitoring

The supply voltage being monitored also provides the operating power for the unit, so an auxiliary supply is not necessary.

### 3-phase asymmetry monitoring

In a 3-phase system, asymmetry is present if at least one of the three L - L voltage vectors fails to be at 120° with respect to the other L - L voltage vectors.

### Detection level

For monitoring relays, this represents, either fixed or adjustable level(s) of voltage, current or phase asymmetry, which define the acceptable limits of operation. Values outside acceptable limits will cause the output relay NO contact to open (after any intentional delay).

### Switch-on lock-out time

For over and under voltage monitoring relays this is a selectable time delay to ensure that the output relay cannot re-energise too quickly (following a trip and the re-establishment of healthy conditions). Protects equipment where a quick succession of restarts might cause overheating and damage. Same delay applies immediately following "power-on".

### Trip on-delay

Similar in effect to the switch-off delay, this delays the "trip" signal that would result in the output relay switching off. The term is used primarily for monitoring relays which monitor and act according to several parameters. But the effect is the same, and momentary or short-term excursions of the measured/monitored values outside of limits are ignored.

### Run-on time

With liquid level control relays the pump motor can be turned on (or off) within 0.5 to 1 second of the liquid reaching or departing the level of the electrode. Depending on model, this delay can be increased up to 7 seconds, which will have the effect of the liquid level running past the electrode level. This can help prevent "hunting" of the motor, which might otherwise have happened due to ripples, or foam, on the surface of the liquid.

### Reaction time

For monitoring relays, this is the maximum time taken by the electronics to respond to changes in the monitored value.

### Fault memory

For monitoring relays; selecting this function will inhibit the automatic reset following clearing of fault condition. Reset can only be made by positive intervention.

### Fault memory - status retained on power down

As above but the fault memory status will be retained during power down.

### Thermistor temperature sensing

Over-temperature monitoring via a PTC resistance sensor, with in-built checking for sensor open or short circuit faults.

### Level control relay

Detects the level of conductive liquids by measuring and evaluating the resistance between either 2 or 3 level electrodes.

### Electrode voltage

For level control relays, this is the nominal voltage between electrodes. Note: this voltage is an alternating voltage, so as to avoid the effects of electrolytic corrosion.

### Electrode current

For level control relays, this is the nominal (AC) electrode current.

### Max. sensitivity

For level control relays: the maximum sensitivity is the maximum resistance between the electrodes that will be recognised as indicating the presence of liquid. This may be fixed, or adjustable over a range - according to type.

### Sensitivity, fixed or adjustable

The resistance value between the electrodes B1-B3 and B2-B3 is used to determine if there is a conductive liquid between the electrodes. The sensitivity is either a fixed level (type 72.11) or an adjustable value (type 72.01). The latter is useful for "tuning out" any false detection of the fluid level arising from detecting surface foam (or head), rather than the liquid itself.

### Positive safety logic

Positive logic means that the make contact is closed, if the level or parameter which is being monitored lies within the target range. The make contact opens, after a delay if appropriate, if the level falls outside of the target range, or level.

## Timers

### Specified time range

The minimum and maximum limits of, one or more time ranges, over which it is possible to set the desired time.

### Repeatability

The difference between the upper and lower limits of a range of values taken from several time measurements of a specified time relay under identical stated conditions. Usually repeatability is indicated as a percentage of the mean value of all measured values.

### Recovery time

The minimum time necessary before re-starting the timer function - in order to maintain the defined timing accuracy.

### Minimum control impulse

The minimum duration of a control impulse (Terminal B1) necessary to ensure the complete and proper time function.

### Setting accuracy

The difference between the measured value of the specified time and the reference value set on the scale.

## Light dependent relays

### Threshold setting

The ambient light level setting, measured in lux (lx), at which the output relay switches on (following the elapse of the ON Delay time). This is adjustable over the range specified in the specification.

The relay will switch off, dependent upon the type of Light dependent relay used, at either the same or a higher brightness value (following the elapse of the OFF Delay time).

### Delay time

Switching ON/OFF For light-dependent relays this is an intentional delay in the response of the output relay, following a change of state within the electronic light sensitive circuit (usually indicated by change of state of an LED).

This is to eliminate the possibility of the output relay unnecessarily responding to a momentary change in ambient light level.

## Time switches

### 1 or 2 pole output types

The 2 pole output type (12.62, 12.A2 and 12.B2) can have both contacts programmed independently of each other.

### Type of time switch

**Daily** Same program every day.

**Weekly** Different program possible for each of the 7 days of the week.

### Programs

For electronic digital time switches, this is the maximum number of switching times that can be stored in memory. A switching time can be used for more than one day (ie. It could apply to Mon, Tues, Wed, Thurs and Friday), but will only use one memory location.

For mechanical daily time switches, this is the maximum number of switching points during the day that can be set.

### Minimum interval setting

For time switches, this it is the minimum time interval that can be programmed.

### Power back-up

The time, following a power failure, over which the time switch will retain the stored programs and the elapsed time information.

## Step relays and staircase timers

### Minimum/Maximum impulse duration

For step relays there is a minimum and a maximum time period for coil energisation. The former is necessary to ensure a full and complete mechanical step action, while exceeding the latter would result in coil overheating and damage.

With the electronic staircase timer, there is no limit to the maximum time for impulse duration.

### Max. number of illuminated push-buttons

For step relays and staircase switches, this is the maximum number of illuminated push-buttons (having current absorption < 1 mA @ 230 V AC) that can be connected without causing problems. If the push-button consumption is higher than 1 mA, the maximum number of push-buttons allowed is proportionally reduced. (i.e. 15 push-buttons x 1 mA is equivalent to 10 push-buttons x 1.5 mA).

## Glow wire conformity according to EN 60335-1

European standard EN 60335-1, "Household and similar electrical appliances - Safety - Part 1: General requirements"; clause 30 prescribes that insulated parts supporting connections that carry current exceeding 0.2 A (and the insulated parts within a distance of 3 mm from them), must comply with the following 2 requirements with respect to resistance to fire:

- 1 - GWFI (Glow Wire Flammability Index) of 850 °C - Compliance with glow wire flammability test at 850 °C (according to EN 60695-2-12).
- 2 - GWIT (Glow Wire Ignition Temperature) of 775 °C according to EN 60695-2-13 - This requirement can be verified with a GWT (Glow Wire Test according to EN 60695-2-11) at a value of 750 °C with a flame extinction within 2 seconds.

The following Finder products comply with the above mentioned requirements:

- electromechanical relays of series **34, 40, 41, 43, 44, 45, 46, 50, 55, 56, 60, 62, 65, 66, 67;**
- PCB or DIN Rail sockets in special versions **9x.xx.7**

Important note: Whilst EN 60335-1 permits the application of an alternative needle flame test (if the flame during test no. 2 burns longer than 2 seconds) this can result in some limitation in the relay's mounting position. Finder products however, have no such limitations, since the materials used do not require the alternative test method to be performed.

## EMC (ElectroMagnetic Compatibility) Standards

Type of test	Reference standard
Electrostatic discharge	EN 61000-4-2
Radio-frequency electromagnetic field (80 ÷ 1000 MHz)	EN 61000-4-3
Fast transients (burst) (5-50 ns, 5 kHz)	EN 61000-4-4
Surges (1.2/50 µs)	EN 61000-4-5
Radio-frequency common mode disturbances (0.15...80 MHz)	EN 61000-4-6
Power-frequency magnetic field (50 Hz)	EN 61000-4-8
Radiated and conducted emission	EN 55011/55014/55022

In panel installations, the most frequent and, particularly, more dangerous type of electrical disturbances are the following:

**Burst (fast transients)**

These are packets of **5/50 ns** pulses, having high peak voltage level but low energy since individual pulses are very short - 5 ns rise time ( $5 \times 10^{-9}$  seconds) and 50 ns fall time.

They simulate the disturbances that can spread along the cables as a consequence of commutation transients from relays, contactors or motors. Usually they are not destructive, but they can affect the correct working of electronic devices.

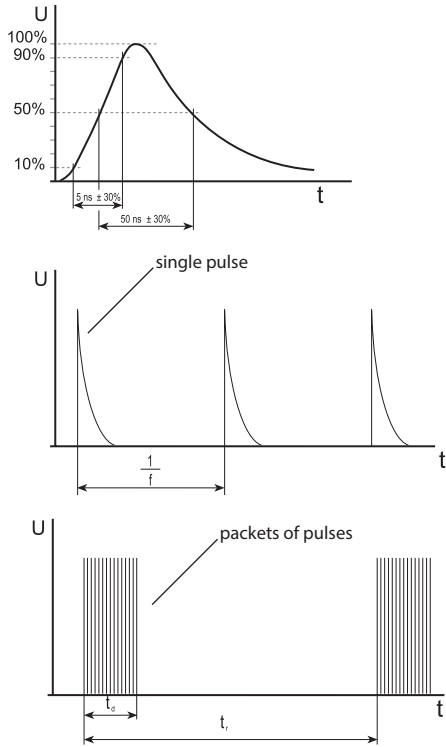

**Surge (voltage pulses)**

These are single **1.2/50 µs** pulses, with energy much higher than bursts since the duration is considerably longer - 1.2 µs rise time ( $1.2 \times 10^{-6}$  seconds) and 50 µs fall time.

For this reason they are very often destructive. The Surge test typically simulates disturbances caused by the propagation of atmospheric electrical storm discharges along electrical lines, but often the switching of power contacts (such as the opening of highly inductive loads) can cause disturbances that are very similar, and equally destructive. The test levels V (peak values of the single pulses) are prescribed in appropriate product standards:

- **EN 61812-1** for electronic timers;
- **EN 60669-2-1** for electronic relays and switches;

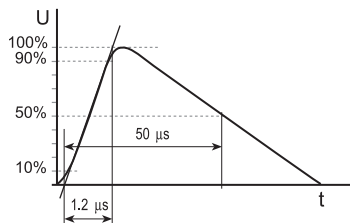

- **EN 61000-6-2** (generic standard for immunity in the industrial environment) for other electronic products for industrial application;
- **EN 61000-6-1** (generic standard for immunity in the domestic environment) for other electronic products for domestic application.

Finder electronic products are in accordance with European EMC Directive **2014/30/EU** and indeed, have immunity capabilities often higher than the levels prescribed in the above mentioned standards. Nevertheless, it is not impossible that some working environments may impose levels of disturbances far in excess of the guaranteed levels, such that the product could be immediately destroyed!

It is therefore necessary to consider Finder products as not being indestructible under all circumstances. The user should pay attention to the disturbances in electrical systems and reduce as much as possible these disturbances. For example, employ arc suppression circuits on the contacts of switches, relays or contactors which otherwise might produce over-voltages when opening electrical circuits (particularly highly inductive or DC loads). Attention should also be paid to the placement of components and cables in such a way as to limit disturbances and their propagation.

**EMC rules**

Require that it is the equipment designer who must ensure that the emissions from panels or equipment does not exceed the limits stated in EN 61000-6-3 (generic standard for emission in the domestic environment) or 61000-6-4 (generic standard for emission in the industrial environment) or any product specific harmonised EMC standard.

**Reliability (MTTF & MTBF for equipment)**

**MTBF, MTTF and MCTF**

Relays are generally considered to be non-repairable items and consequently require replacement following failure. Consequently, if a worn relay within equipment is replaced, its MTTF (Mean Time To Failure) value is appropriate in calculating the MTBF (Mean Time Between Failure) for the equipment. The predominant failure mode for elementary relays is attributable to the wear-out mechanism affecting the relay contacts. This can be expressed in terms of MCTF (Mean Cycles To Failure). With knowledge of the frequency of operation f (cycling rate, expressed in cycles/hour) of the relay within the equipment, the number of cycles can be simply transformed, using the relation  $MTTF = MCTF / f$ , into a respective time (expressed in hours), giving the effective MTTF value for the relay in that application.

**MCTF, B<sub>10</sub> and B<sub>10d</sub> for Finder relays**

The electrical contact life for a Finder relay, as indicated by its associated "F" chart in the relay data-sheet, can be taken as the relay B<sub>10</sub> figure, which is the statistical 10% fractile of lifetime (or, more simply, the expected time at which 10% of the population will have failed).

For Finder relays it is possible to estimate a relationship between it and the MCTF value, using the rough approximation  $MCTF = 1.5 \times B_{10}$ .

The B<sub>10d</sub> value refers to dangerous failures, and is derived from the B<sub>10</sub> value from the relationship:  $B_{10d} = B_{10} \times 10/N_d$ , where N<sub>d</sub> is the number of registered dangerous failures on 10 tested relays.

For a precise value it is of course necessary to test at least 10 relays, however for Finder relays it is possible to estimate using the rough approximation  $B_{10d} = 2 \times B_{10}$ .

**Example** 40.31 relay, switching a 10 A current on a resistive load, at 250 V AC, with a frequency of operation of 10 cycles per hour:

- from the chart "F40.1" we can see the electrical life value to be 200 000 cycles and can take it to represent the B<sub>10</sub> value;
- this value, multiplied by 1.5 gives an MCTF value of about 300 000 cycles;
- this 300 000, divided by the cycling rate (10 cycles/hour), gives a MTTF value of 30 000 hours;
- the B<sub>10d</sub> value can then be estimated (multiplying by 2 the B<sub>10</sub> value) as 400 000 cycles.

## RoHS, REACH & WEEE directives

Recent directives approved by the European Union aim to reduce potentially hazardous substances contained in electrical and electronic equipment - minimising risks to health and the environment, and guaranteeing the safe reuse, recycling or ultimate disposal of equipment.

Finder products comply with the relevant requirements of these Directives. Details and updated references can be found on the Finder website.

### CADMIUM

**Following the European Commission decision 2005/747/EC dated 21st October 2005, cadmium and its compounds are still permitted in electrical contacts. Consequently, relays with AgCdO contacts are acceptable in all applications.** However, if required, the majority of Finder relays are currently available in "Cadmium-free" versions (for example, AgNi or AgSnO<sub>2</sub>). But, it should be noted that AgCdO achieves a particularly good balance between the electrical life and the switching capacity of, for example, solenoids and inductive loads in general (particularly DC loads), motor loads and higher power resistive loads.

Alternative materials such as AgNi and AgSnO<sub>2</sub>, do not always offer the same performance for electrical life as AgCdO, although this depends on both the type of load and application (see Table 5 under Contact specification section).

## SIL and PL categories

**SIL and PL categories relate to the statistical reliability of Safety Related Electrical Control Systems (SRECS). They are defined, respectively, in the following standards: EN 62061 (sector standard deriving from EN/IEC 61508 and listed as a Harmonized standard under the EU Machinery Directive) and EN ISO 13849-1 (which replaces EN 954-1 and is specifically intended to cover machines and process plant).**

From the point of view of a user who is implementing safety controls using electrical / electronic / programmable systems, there is no clear distinction as to which standard should be used for any particular application, whether EN 62061 or ISO 13849-1. Either standard can be used as guidance for both hardware and application software for systems up to the highest integrity or performance as identified by the standard. Some of the considerations that might influence the choice of standard are:

- Customer requirements to demonstrate the safety integrity of a machine control system in terms of a Safety Integrity Level (SIL) may mean the use of IEC 62061 is more appropriate;
- Control systems of machinery used in, for example, process industries where other safety related systems (such as safety instrumented systems in accordance with IEC 61511) are characterised in terms of SILs may mean the use of IEC 62061 is more appropriate;
- Control system based upon media other than electrical may mean that the use of ISO 13849-1 is more appropriate.

Both standards use the concept of functional safety which means specifying the safety requirements in terms of the functional requirements (for example: "WHEN THE GUARD IS OPENED HAZARDOUS MOVEMENT MUST BE STOPPED"), and the amount of risk reduction required. EN 62061 uses Safety Integrity Levels (SIL), EN 13849-1 uses Performance Levels (PL). Both standards require the user to follow essentially the same series of steps:

- Access the Risks
- Allocate the Safety measures
- Design Architecture
- Validate

Both standards have a recommended risk assessment method to help establish the risk reduction that is required from a particular safety function; although the methods are quite different the outcomes should be the same (or very similar) for any given function.

## SIL Classes - according to EN 62061

The severity of possible harm is assessed as one of four levels. The probability of the hazardous event occurring is then assessed by considering 3 further parameters in a range of point scores, these scores are summed to give the class (Cl). The class is then plotted against the severity in a simple matrix to establish the target SIL for the function.

The SIL (Safety Integrity Level) classifies, as one of 4 classes (SIL 0 to SIL 3), the dangers and risks that would be consequential to a particular application malfunctioning. This in turn generates the need for any associated SRECS to perform with an appropriate level of reliability. Applications, where the consequences of a failure of the control system are assessed as low (SIL 0) can tolerate a relatively high statistical probability of a control system failure occurring. Conversely, applications where the dangerous consequences of a failure of the control system are assessed as very high (SIL 3), cannot tolerate anything other than a control system with the highest (statistically assured) reliability. The reliability of the (overall) control system is specified in terms of the "Statistical probability of a dangerous system failure per hour".

## PL Classes - according to EN ISO 13849-1

The risk assessment methodology given in EN ISO 13849-1 is in the form of a qualitative risk graph which is an enhanced version of the well-known risk graph that was in EN 954-1.

The output of the risk graph indicates a required performance level of a, b, c, d, e and clearly the greater the risk exposure to a hazard, the higher the performance of the safety related control needs to be.

## Points of commonality between EN 62061 and EN ISO 13849-1

There is clearly correspondence between the SIL required according to EN 62061 and the PL required according to EN ISO 13849-1 because the numeric values for the "statistical probability of a dangerous fault per hour" are to a large extent the same for EN 62061 and EN ISO 13849-1.

SIL 1 corresponds to PL b & c, SIL 2 corresponds to PL d and SIL 3 corresponds to PL e.

Both standards define the statistical probability of a SERCS failure, and not the failure of a component. It is the responsibility of the system designer to ensure that a failure of a component does not compromise the required safety integrity of the system.

IEC EN 62061 (Safety Integrity Level)	"Statistical probability of a dangerous system failure per hour"	EN ISO 13849-1 (Performance Level)
No special safety requirements	$\geq 10^{-5} \dots < 10^{-4}$	a
1	$\geq 3 \times 10^{-6} \dots < 10^{-5}$	b
	$\geq 10^{-6} \dots < 3 \times 10^{-6}$	c
2	$\geq 10^{-7} \dots < 10^{-6}$	d
3	$\geq 10^{-8} \dots < 10^{-7}$	e

## Component reliability

The safety control system designer needs to take into account the reliability of components. Accordingly, the most predictable failure for a relay is contact wear-out at moderate to high contact loading. But, as relay reliability standard EN 61810-2 emphasises, relays are not repairable, and this in particular needs to be taken into account when estimating the "statistical probability of a dangerous system failure per hour". See Reliability section.

For relays, the number of switching cycles before failure is predominantly determined by the life of the contacts, and consequently is dependent upon contact loading. The F-diagrams in the Finder catalogue can be regarded as indicating the B<sub>10</sub> Value of a Weibull type distribution of electrical life (for a 230 V AC1 load); from which the MCTF can be derived and used ultimately in calculating the "statistical probability of a dangerous system failure per hour" for the safety control system.



### Certifications and Quality Approvals

		<b>CE</b>	<b>EU</b>	
	UK Conformity Assessed	<b>UKCA</b>	United Kingdom	
		<b>ATEX</b>	<b>EU</b>	
		<b>IECEx</b>	<b>World</b>	
		<b>UL HazLoc</b>	<b>USA</b>	
	Asociación de Normalización y Certificación, A.C.	<b>ANCE</b>	Mexico	
	China quality Certification Centre	<b>CCC</b>	China	
	Canadian Standards Association	<b>CSA</b>	Canada	
	EurAsian Conformity	<b>EAC</b>	Russia, Belarus, Kazakhstan, Armenia and Kyrgyzstan	
	European Norms Electrical Certification	<b>ENEC</b>	Europe	
	Istituto Italiano del Marchio di Qualità	<b>IMQ</b>	Italy	
	Laboratoire Central des Industries Electriques	<b>LCIE</b>	France	
	Lloyd's Register of Shipping	Lloyd's Register	United Kingdom	
<b>RINA</b>	Registro Italiano Navale	<b>RINA</b>	Italy	
	Regulatory Compliance Mark	<b>RCM</b>	Australia	
	TÜV Rheinland	<b>TUV</b>	Germany	
	TÜV SÜD			
	Underwriters Laboratories	<b>UL</b>	USA	
	Underwriters Laboratories	<b>UL</b>	USA Canada	
	VDE Prüf- und Zertifizierungsinstitut Zeichengenehmigung	<b>VDE</b>	Germany	
	Servimeetr	<b>SM</b>	Colombia	
	Russian Maritime Register of Shipping	<b>RMRS</b>	Russia	

