



Electric Automation
Automation specialists

Referência: RTM 150 FS
Código: 6042020

pedaço T-filial com conexão rápida,
110x500, banda galvanizado, DIN EN
10147, de aço, St

A partir de Electric Automation Network

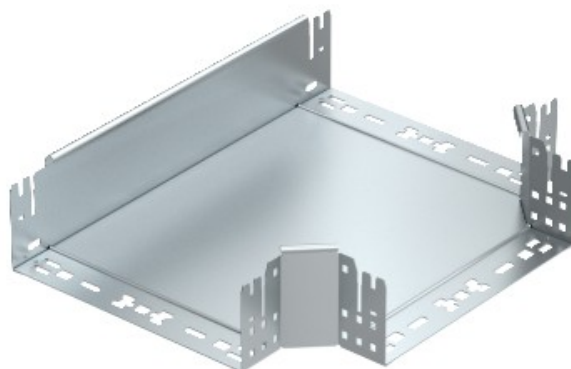

T ramo peça com conector rápido do sistema. Para todos os bandeja de cabo tipos de 110 mm de altura da lateral.