



■ Features :

- Universal AC input / Full range
- Protections: Short circuit / Overload / Over voltage
- Cooling by free air convection
- LED indicator for power on
- 100% full load burn-in test
- All using 105°C long life electrolytic capacitors
- Withstand 300VAC surge input for 5 second
- High operating temperature up to 70°C
- Withstand 5G vibration test
- High efficiency, long life and high reliability
- 3 years warranty



SPECIFICATION

MODEL		RQ-65B				RQ-65C				RQ-65D				
OUTPUT	OUTPUT NUMBER	CH1	CH2	CH3	CH4	CH1	CH2	CH3	CH4	CH1	CH2	CH3	CH4	
	DC VOLTAGE	5V	12V	-5V	-12V	5V	15V	-5V	-15V	5V	12V	24V	-12V	
	RATED CURRENT	6A	2A	0.5A	0.5A	5A	2A	0.5A	0.5A	4A	1.5A	1A	0.5A	
	CURRENT RANGE <small>Note.6</small>	0.5 ~ 8A	0.2 ~ 3A	0 ~ 1A	0 ~ 1A	0.5 ~ 8A	0.2 ~ 3A	0 ~ 1A	0 ~ 1A	0.5 ~ 8A	0.2 ~ 3A	0.1 ~ 1.5A	0 ~ 1A	
	RATED POWER <small>Note.6</small>	62.5W				65W				68W				
	RIPPLE & NOISE (max.) <small>Note.2</small>	80mVp-p	120mVp-p	80mVp-p	80mVp-p	80mVp-p	120mVp-p	80mVp-p	80mVp-p	80mVp-p	80mVp-p	120mVp-p	180mVp-p	80mVp-p
	VOLTAGE ADJ. RANGE	CH1: 4.75 ~ 5.5V				CH1: 4.75 ~ 5.5V				CH1: 4.75 ~ 5.5V				
	VOLTAGE TOLERANCE <small>Note.3</small>	±2.0%	+9,-5%	±5.0%	±5.0%	±2.0%	+10,-4%	±5.0%	±5.0%	±2.0%	±6.0%	±8.0%	±5.0%	
	LINE REGULATION <small>Note.4</small>	±0.5%	±1.5%	±0.5%	±0.5%	±0.5%	±1.5%	±0.5%	±0.5%	±0.5%	±1.5%	±2.0%	±0.5%	
	LOAD REGULATION <small>Note.5</small>	±0.5%	±3.0%	±1.0%	±1.0%	±0.5%	±4.0%	±1.0%	±1.0%	±0.5%	±3.0%	±5.0%	±1.0%	
SETUP, RISE TIME	500ms, 20ms/230VAC				1200ms, 30ms/115VAC at full load									
HOLD UP TIME (Typ.)	60ms/230VAC				14ms/115VAC at full load									
INPUT	VOLTAGE RANGE	88 ~ 264VAC		125 ~ 373VDC (Withstand 300VAC surge for 5sec. Without damage)										
	FREQUENCY RANGE	47 ~ 63Hz												
	EFFICIENCY (Typ.)	76%				76%				78%				
	AC CURRENT (Typ.)	2A/115VAC		1.2A/230VAC										
	INRUSH CURRENT (Typ.)	COLD START 40A/230VAC												
LEAKAGE CURRENT	<2mA / 240VAC													
PROTECTION	OVERLOAD	110 ~ 150% rated output power Protection type : Hiccup mode, recovers automatically after fault condition is removed												
	OVER VOLTAGE	CH1: 5.75 ~ 6.75V Protection type : Hiccup mode, recovers automatically after fault condition is removed												
ENVIRONMENT	WORKING TEMP.	-25 ~ +70°C (Refer to "Derating Curve")												
	WORKING HUMIDITY	20 ~ 90% RH non-condensing												
	STORAGE TEMP., HUMIDITY	-40 ~ +85°C, 10 ~ 95% RH												
	TEMP. COEFFICIENT	±0.03%/°C (0 ~ 50°C) on +5V output												
VIBRATION	10 ~ 500Hz, 5G 10min./1cycle, period for 60min. each along X, Y, Z axes													
SAFETY & EMC (Note 7)	SAFETY STANDARDS	UL60950-1, TUV EN60950-1 approved												
	WITHSTAND VOLTAGE	I/P-O/P:3KVAC I/P-FG:2KVAC O/P-FG:0.5KVAC												
	ISOLATION RESISTANCE	I/P-O/P, I/P-FG, O/P-FG:100M Ohms / 500VDC / 25°C/ 70% RH												
	EMC EMISSION	Compliance to EN55032 (CISPR32) Class B, EN61000-3-2,-3												
EMC IMMUNITY	Compliance to EN61000-4-2,3,4,5,6,8,11, EN61000-6-2 (EN50082-2), heavy industry level, criteria A													
OTHERS	MTBF	245.5Khrs min. MIL-HDBK-217F (25°C)												
	DIMENSION	129*98*38mm (L*W*H)												
	PACKING	0.44Kg; 30pcs/13.2Kg/0.72CUFT												
NOTE	<ol style="list-style-type: none"> 1. All parameters NOT specially mentioned are measured at 230VAC input, rated load and 25°C of ambient temperature. 2. Ripple & noise are measured at 20MHz of bandwidth by using a 12" twisted pair-wire terminated with a 0.1uf & 47uf parallel capacitor. 3. Tolerance : includes set up tolerance, line regulation and load regulation. 4. Line regulation is measured from low line to high line at rated load. 5. Load regulation is measured from 20% to 100% rated load, and other output at 60% rated load. 6. Each output can work within current range. But total output power can't exceed rated output power. 7. The power supply is considered a component which will be installed into a final equipment. All the EMC tests are been executed by mounting the unit on a 360mm*360mm metal plate with 1mm of thickness. The final equipment must be re-confirmed that it still meets EMC directives. For guidance on how to perform these EMC tests, please refer to "EMI testing of component power supplies." (as available on http://www.meanwell.com) 													

Mechanical Specification

Case No. 903 Unit:mm

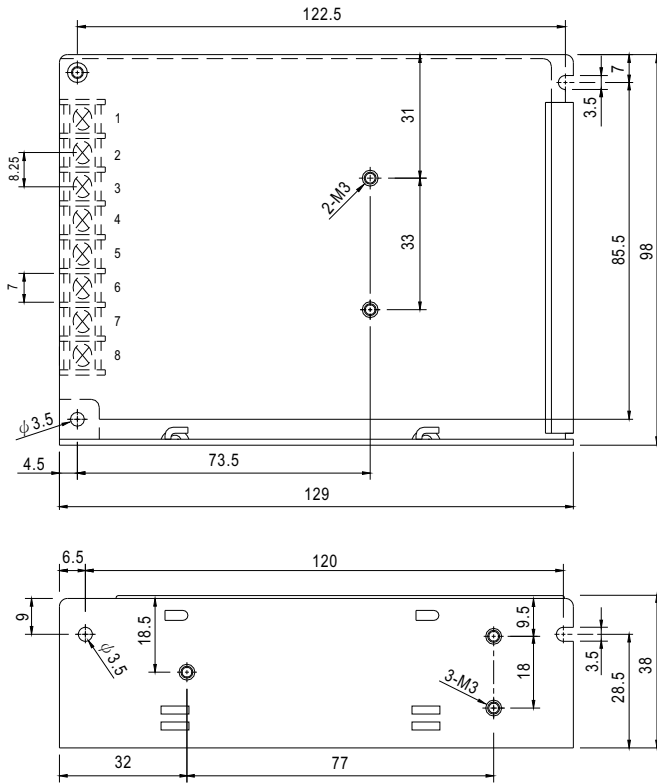

Terminal Pin No. Assignment

Pin No.	Assignment	Pin No.	Assignment
1	AC/L	5	DC OUTPUT V3
2	AC/N	6	DC OUTPUT +V2
3	FG \perp	7	DC OUTPUT COM
4	DC OUTPUT -V4	8	DC OUTPUT +V1

Block Diagram

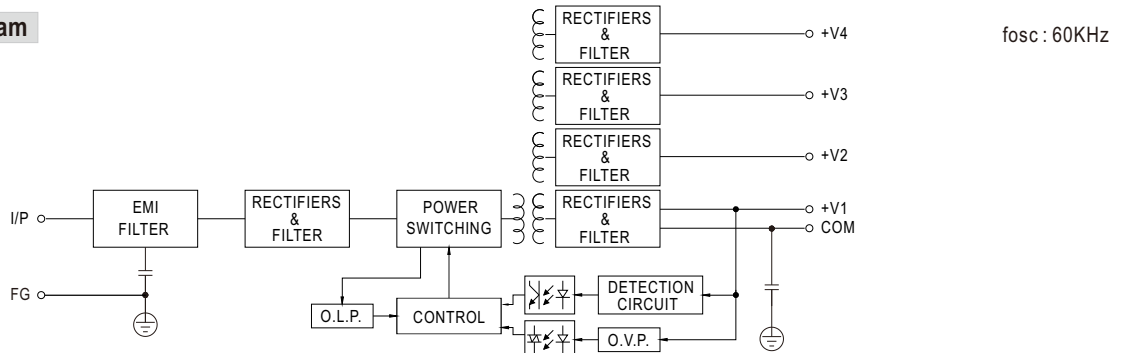

Derating Curve

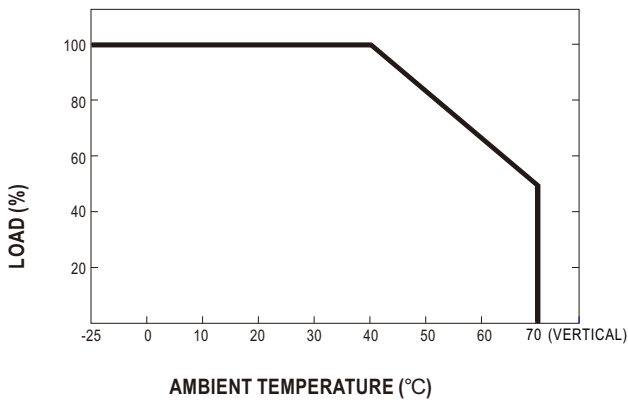

Output Derating VS Input Voltage

