



**Non-standard switch, TM, 10 A, centre mounting, 1 contact unit(s), customized version according to form, TM mini rotary switches, ordering for the first time**



**Part no. TM-1-SOND-ERSTBESTELLUNG/EZ**  
**Catalog No. 208262**

### Delivery program

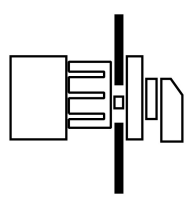
Product range			Non-standard switch
Part group reference			TM
<b>Notes</b>			customized version according to form
Non-standard order			TM mini rotary switches, ordering for the first time
Degree of Protection			Front IP65
Design			centre mounting
			
<b>Motor rating AC-23A, 50 - 60 Hz</b>			
400 V	P	kW	3
Rated uninterrupted current	$I_u$	A	10
Note on rated uninterrupted current $I_u$			Rated uninterrupted current $I_u$ is specified for max. cross-section.
Number of contact units		contact unit(s)	1

### Design verification as per IEC/EN 61439

Technical data for design verification			
Rated operational current for specified heat dissipation	$I_n$	A	10
Heat dissipation per pole, current-dependent	$P_{vid}$	W	0.15
Equipment heat dissipation, current-dependent	$P_{vid}$	W	0
Static heat dissipation, non-current-dependent	$P_{vs}$	W	0
Heat dissipation capacity	$P_{diss}$	W	0
Operating ambient temperature min.		°C	-25
Operating ambient temperature max.		°C	50
IEC/EN 61439 design verification			
10.2 Strength of materials and parts			
10.2.2 Corrosion resistance			Meets the product standard's requirements.
10.2.3.1 Verification of thermal stability of enclosures			Meets the product standard's requirements.
10.2.3.2 Verification of resistance of insulating materials to normal heat			Meets the product standard's requirements.
10.2.3.3 Verification of resistance of insulating materials to abnormal heat and fire due to internal electric effects			Meets the product standard's requirements.
10.2.4 Resistance to ultra-violet (UV) radiation			UV resistance only in connection with protective shield.
10.2.5 Lifting			Does not apply, since the entire switchgear needs to be evaluated.
10.2.6 Mechanical impact			Does not apply, since the entire switchgear needs to be evaluated.
10.2.7 Inscriptions			Meets the product standard's requirements.
10.3 Degree of protection of ASSEMBLIES			Does not apply, since the entire switchgear needs to be evaluated.
10.4 Clearances and creepage distances			Meets the product standard's requirements.
10.5 Protection against electric shock			Does not apply, since the entire switchgear needs to be evaluated.
10.6 Incorporation of switching devices and components			Does not apply, since the entire switchgear needs to be evaluated.
10.7 Internal electrical circuits and connections			Is the panel builder's responsibility.
10.8 Connections for external conductors			Is the panel builder's responsibility.
10.9 Insulation properties			

10.9.2 Power-frequency electric strength		Is the panel builder's responsibility.
10.9.3 Impulse withstand voltage		Is the panel builder's responsibility.
10.9.4 Testing of enclosures made of insulating material		Is the panel builder's responsibility.
10.10 Temperature rise		The panel builder is responsible for the temperature rise calculation. Eaton will provide heat dissipation data for the devices.
10.11 Short-circuit rating		Is the panel builder's responsibility. The specifications for the switchgear must be observed.
10.12 Electromagnetic compatibility		Is the panel builder's responsibility. The specifications for the switchgear must be observed.
10.13 Mechanical function		The device meets the requirements, provided the information in the instruction leaflet (IL) is observed.

## Technical data ETIM 7.0

Low-voltage industrial components (EG000017) / Control switch (EC002611)		
Electric engineering, automation, process control engineering / Low-voltage switch technology / Off-load switch, circuit breaker, control switch / Control switch (ecl@ss10.0.1-27-37-14-14 [ACN998011])		
Type of switch		
Number of poles		0
Max. rated operation voltage Ue AC	V	500
Rated permanent current Iu	A	10
Number of switch positions		0
With 0 (off) position		No
With retraction in 0-position		No
Device construction		Built-in device
Width in number of modular spacings		0
Suitable for ground mounting		No
Suitable for front mounting 4-hole		Yes
Suitable for distribution board installation		No
Suitable for intermediate mounting		No
Complete device in housing		No
Type of control element		Toggle
Front shield size		30x30 mm
Degree of protection (IP), front side		IP65
Degree of protection (NEMA), front side		Other

## Dimensions

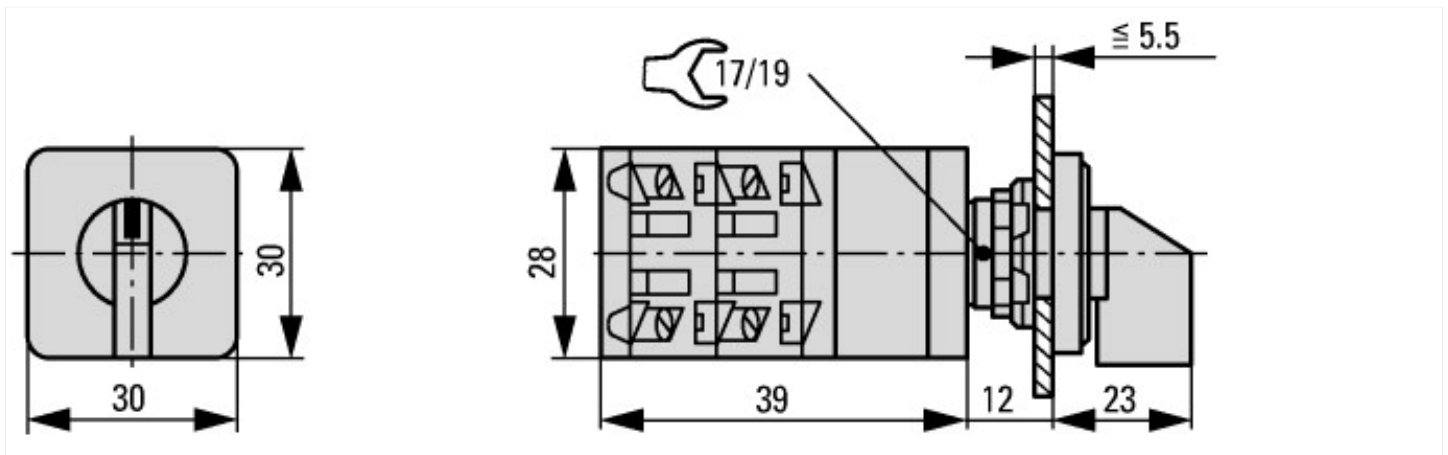

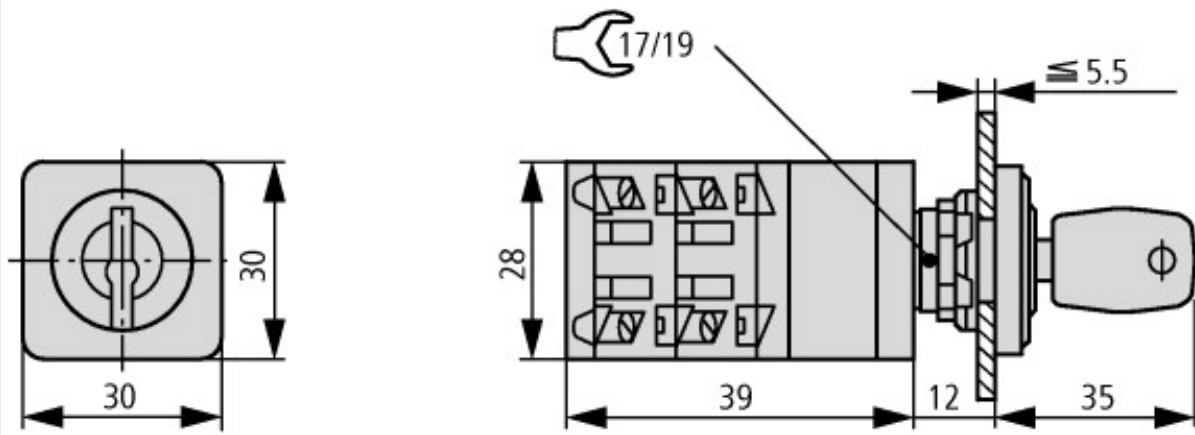

Key operation lock mechanism



Door drilling dimensions

Drilling dimensions: either 16.2 mm = without reduction  $\triangle$  RMQ16 or 22.3 mm = with reduction  $\triangle$  RMQ Titan

### Additional product information (links)

Ordering form for SOND switches and SOND front plates(DE\_EN)

[ftp://ftp.moeller.net/DOCUMENTATION/PDF/MZ008005ZU\\_Orderform\\_Customized\\_Switch.pdf](ftp://ftp.moeller.net/DOCUMENTATION/PDF/MZ008005ZU_Orderform_Customized_Switch.pdf)

Ordering form for SOND switches and SOND front plates(DE\_EN)

[ftp://ftp.moeller.net/DOCUMENTATION/PDF/MZ008006ZU\\_Orderform\\_Customized\\_Switch.pdf](ftp://ftp.moeller.net/DOCUMENTATION/PDF/MZ008006ZU_Orderform_Customized_Switch.pdf)