



Circuit-breaker, 4p, 500A, withdrawable unit

Part no. **NZMN3-4-A500-AVE**
 Catalog No. **113536**

Similar to illustration

Delivery program

Product range			Circuit-breaker
Protective function			System and cable protection
Standard/Approval			IEC
Installation type			Withdrawable
Release system			Thermomagnetic release
Construction size			NZM3
Description			Set value in neutral conductor is synchronous with set value I_r of main pole.
Number of poles			4 pole
Standard equipment			Screw connection





Switching capacity

400/415 V 50 Hz	I_{cu}	kA	50
-----------------	----------	----	----

Rated current = rated uninterrupted current

Rated current = rated uninterrupted current	$I_n = I_u$	A	500
Neutral conductor	% of phase conductor	CSA	100

Setting range

Overload trip			
	I_r	A	400 - 500
Main pole 	I_r	A	400 - 500
Short-circuit releases			
			
Non-delayed 	$I_i = I_n \times \dots$		6 - 10

Technical data

General

Standards			IEC/EN 60947
Protection against direct contact			Finger and back of hand proof to VDE 0106 Part 100
Climatic proofing			Damp heat, constant, to IEC 60068-2-78 Damp heat, cyclic, to IEC 60068-2-30
Ambient temperature			
Ambient temperature, storage		°C	- 40 - + 70
Operation		°C	-25 - +70
Mechanical shock resistance (10 ms half-sinusoidal shock) according to IEC 60068-2-27		g	20 (half-sinusoidal shock 20 ms)
Safe isolation to EN 61140			
Between auxiliary contacts and main contacts		V AC	500
between the auxiliary contacts		V AC	300
Weight		kg	8.4
Mounting position			Vertical and 90° in all directions



With XFI earth-fault release:
 - NZM1, N1, NZM2, N2: vertical and 90° in all directions
 with plug-in unit
 - NZM1, N1, NZM2, N2: vertical, 90° right/left
 with withdrawable unit:
 - NZM3, N3: vertical, 90° right/left
 - NZM4, N4: vertical
 with remote operator:
 - NZM2, N(S)2, NZM3, N(S)3, NZM4, N(S)4: vertical and 90° in all directions

Direction of incoming supply		as required
Degree of protection		
Device		In the operating controls area: IP20 (basic degree of protection)
Enclosures		With insulating surround: IP40 With door coupling rotary handle: IP66
Terminations		Tunnel terminal: IP10 Phase isolator and strip terminal: IP00
Other technical data (sheet catalogue)		Temperature dependency, Derating

Circuit-breakers

Rated current = rated uninterrupted current	$I_n = I_u$	A	500
Rated surge voltage invariability	U_{imp}		
Main contacts		V	8000
Auxiliary contacts		V	6000
Rated operational voltage	U_e	V AC	690
Overvoltage category/pollution degree			III/3
Rated insulation voltage	U_i	V	1000
Use in unearthed supply systems		V	≤ 690

Switching capacity

Rated short-circuit making capacity	I_{cm}		
240 V	I_{cm}	kA	187
400/415 V	I_{cm}	kA	105
440 V 50/60 Hz	I_{cm}	kA	74
525 V 50/60 Hz	I_{cm}	kA	53
690 V 50/60 H	I_c	kA	40
Rated short-circuit breaking capacity I_{cn}	I_{cn}		
I_{cu} to IEC/EN 60947 test cycle O-t-CO	I_{cu}	kA	
240 V 50/60 Hz	I_{cu}	kA	85
400/415 V 50/60 Hz	I_{cu}	kA	50
440 V 50/60 Hz	I_{cu}	kA	35
525 V 50/60 Hz	I_{cu}	kA	25
690 V 50/60 Hz	I_{cu}	kA	20
I_{cs} to IEC/EN 60947 test cycle O-t-CO-t-CO	I_{cs}	kA	
240 V 50/60 Hz	I_{cs}	kA	85
400/415 V 50/60 Hz	I_{cs}	kA	50
440 V 50/60 Hz	I_{cs}	kA	35
525 V 50/60 Hz	I_{cs}	kA	13
690 V 50/60 Hz	I_{cs}	kA	5
Rated short-time withstand current			Maximum back-up fuse, if the expected short-circuit currents at the installation location exceed the switching capacity of the circuit-breaker.
$t = 0.3$ s	I_{cw}	kA	3.3
$t = 1$ s	I_{cw}	kA	3.3
Utilization category to IEC/EN 60947-2			A
Lifespan, mechanical(of which max. 50 % trip by shunt/undervoltage release)	Operations		15000
Lifespan, electrical			
AC-1			
400 V 50/60 Hz	Operations		5000

415 V 50/60 Hz	Operations	5000
690 V 50/60 Hz	Operations	3000
AC--3		
400 V 50/60 Hz	Operations	2000
415 V 50/60 Hz	Operations	2000
690 V 50/60 Hz	Operations	2000
Max. operating frequency	Ops/h	60
Total break time at short-circuit	ms	< 10

Terminal capacity

Standard equipment			Screw connection
Accessories required			NZM3-4-XAVS
Optional accessories			Box terminal Tunnel terminal connection on rear
Round copper conductor			
Box terminal			
Solid		mm ²	2 x 16
Stranded		mm ²	1 x (35 - 240) 2 x (25-120)
Tunnel terminal			
Solid		mm ²	1 x 16
Stranded			
1-hole		mm ²	1 x (16 - 185)
Bolt terminal and rear-side connection			
Direct on the switch			
Solid		mm ²	1 x 16 2 x 16
Stranded		mm ²	1 x (25 - 240) 2 x (25 - 240)
Connection width extension		mm ²	
Connection width extension		mm ²	2 x 300
Al circular conductor			
Tunnel terminal			
Solid		mm ²	1 x 16
Stranded			
Stranded		mm ²	1 x (25 - 185) ²⁾
Double hole		mm ²	1 x (50 - 240) 2 x (50 - 240)
			²⁾ Up to 240 mm ² can be connected depending on the cable manufacturer.
Cu strip (number of segments x width x segment thickness)			
Box terminal			
	min.	mm	6 x 16 x 0.8
	max.	mm	10 x 24 x 1.0 + 5 x 24 x 1.0 (2 x) 8 x 24 x 1.0
Bolt terminal and rear-side connection			
Flat copper strip, with holes	min.	mm	6 x 16 x 0.8
Flat copper strip, with holes	max.	mm	10 x 32 x 1.0 + 5 x 32 x 1.0
Connection width extension		mm	(2 x) 10 x 50 x 1.0
Copper busbar (width x thickness)		mm	
Bolt terminal and rear-side connection			
Screw connection			M10
Direct on the switch			
	min.	mm	20 x 5
	max.	mm	30 x 10 + 30 x 5
Connection width extension		mm	
Connection width extension	max.	mm	2 x (10 x 50)

Control cables			
		mm ²	1 x (0.75 - 2.5) 2 x (0.75 - 1.5)

Design verification as per IEC/EN 61439

Technical data for design verification			
Rated operational current for specified heat dissipation	I _n	A	500
Equipment heat dissipation, current-dependent	P _{vid}	W	130.5
Operating ambient temperature min.		°C	-25
Operating ambient temperature max.		°C	70
IEC/EN 61439 design verification			
10.2 Strength of materials and parts			
10.2.2 Corrosion resistance			
			Meets the product standard's requirements.
10.2.3.1 Verification of thermal stability of enclosures			
			Meets the product standard's requirements.
10.2.3.2 Verification of resistance of insulating materials to normal heat			
			Meets the product standard's requirements.
10.2.3.3 Verification of resistance of insulating materials to abnormal heat and fire due to internal electric effects			
			Meets the product standard's requirements.
10.2.4 Resistance to ultra-violet (UV) radiation			
			Meets the product standard's requirements.
10.2.5 Lifting			
			Does not apply, since the entire switchgear needs to be evaluated.
10.2.6 Mechanical impact			
			Does not apply, since the entire switchgear needs to be evaluated.
10.2.7 Inscriptions			
			Meets the product standard's requirements.
10.3 Degree of protection of ASSEMBLIES			
			Does not apply, since the entire switchgear needs to be evaluated.
10.4 Clearances and creepage distances			
			Meets the product standard's requirements.
10.5 Protection against electric shock			
			Does not apply, since the entire switchgear needs to be evaluated.
10.6 Incorporation of switching devices and components			
			Does not apply, since the entire switchgear needs to be evaluated.
10.7 Internal electrical circuits and connections			
			Is the panel builder's responsibility.
10.8 Connections for external conductors			
			Is the panel builder's responsibility.
10.9 Insulation properties			
10.9.2 Power-frequency electric strength			
			Is the panel builder's responsibility.
10.9.3 Impulse withstand voltage			
			Is the panel builder's responsibility.
10.9.4 Testing of enclosures made of insulating material			
			Is the panel builder's responsibility.
10.10 Temperature rise			
			The panel builder is responsible for the temperature rise calculation. Eaton will provide heat dissipation data for the devices.
10.11 Short-circuit rating			
			Is the panel builder's responsibility. The specifications for the switchgear must be observed.
10.12 Electromagnetic compatibility			
			Is the panel builder's responsibility. The specifications for the switchgear must be observed.
10.13 Mechanical function			
			The device meets the requirements, provided the information in the instruction leaflet (IL) is observed.

Technical data ETIM 7.0

Low-voltage industrial components (EG000017) / Power circuit-breaker for trafo/generator/installation protection (EC000228)			
Electric engineering, automation, process control engineering / Low-voltage switch technology / Circuit breaker (LV < 1 kV) / Circuit breaker for power transformer, generator and system protection (ecl@ss10.0.1-27-37-04-09 [AJZ716013])			
Rated permanent current I _u		A	500
Rated voltage		V	690 - 690
Rated short-circuit breaking capacity I _{cu} at 400 V, 50 Hz		kA	50
Overload release current setting		A	400 - 500
Adjustment range short-term delayed short-circuit release		A	0 - 0
Adjustment range undelayed short-circuit release		A	6 - 10
Integrated earth fault protection			No
Type of electrical connection of main circuit			Screw connection
Device construction			Built-in device slide-in technique (withdrawable)
Suitable for DIN rail (top hat rail) mounting			No
DIN rail (top hat rail) mounting optional			No
Number of auxiliary contacts as normally closed contact			0
Number of auxiliary contacts as normally open contact			0
Number of auxiliary contacts as change-over contact			0

With switched-off indicator		No
With under voltage release		No
Number of poles		4
Position of connection for main current circuit		Front side
Type of control element		Rocker lever
Complete device with protection unit		Yes
Motor drive integrated		No
Motor drive optional		Yes
Degree of protection (IP)		IP20

Characteristics

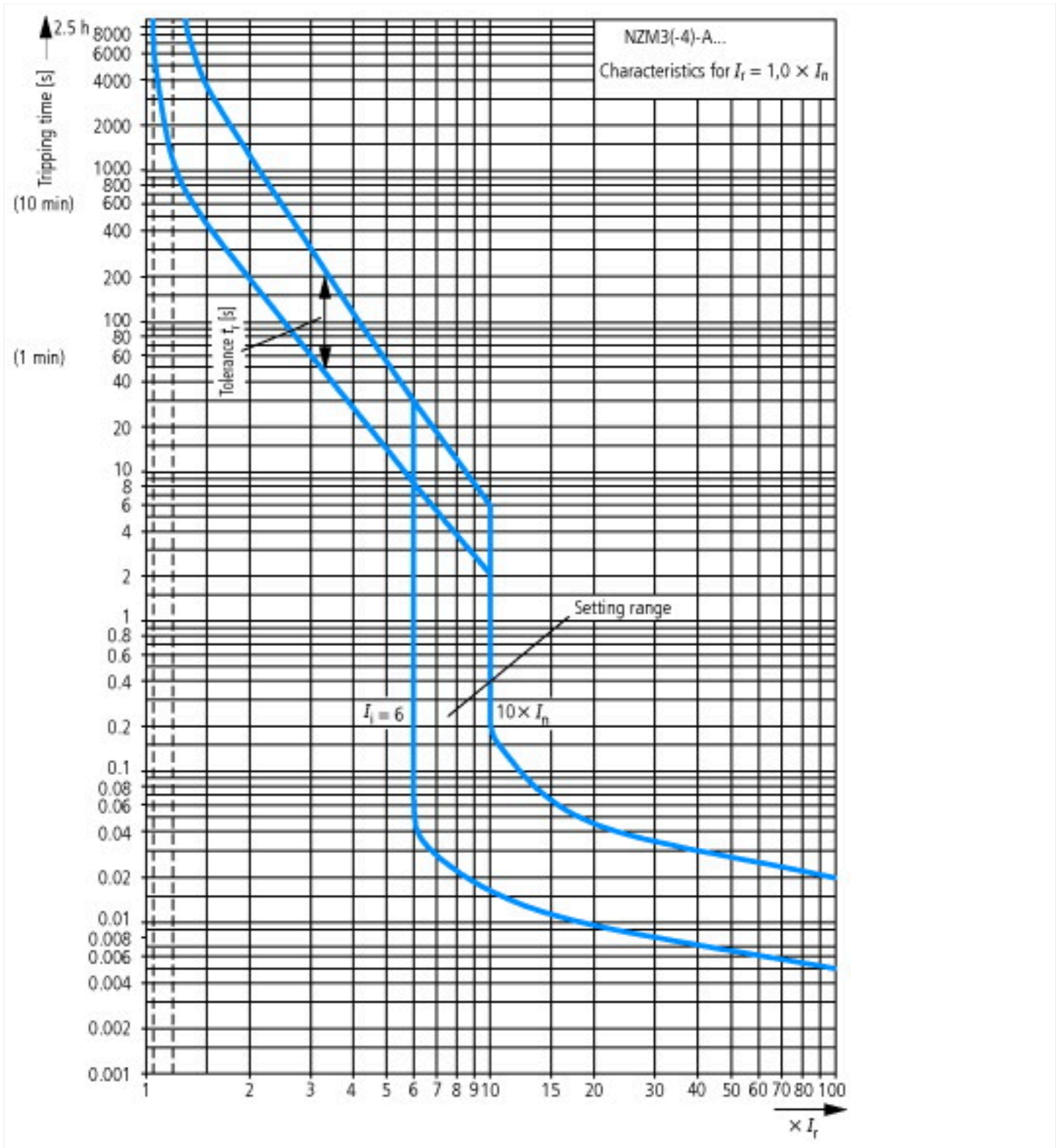



Let-through current

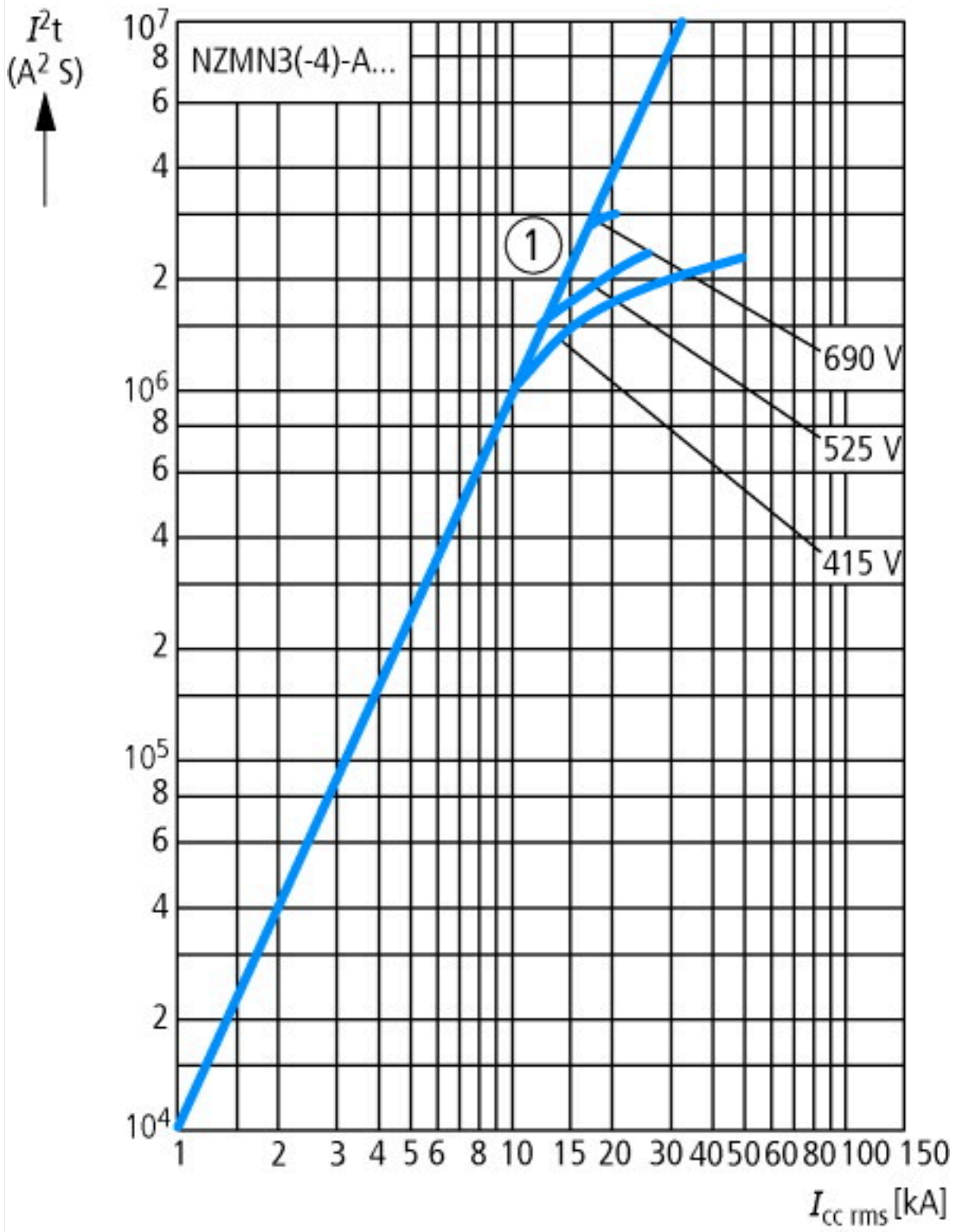

Let-through energy

Dimensions

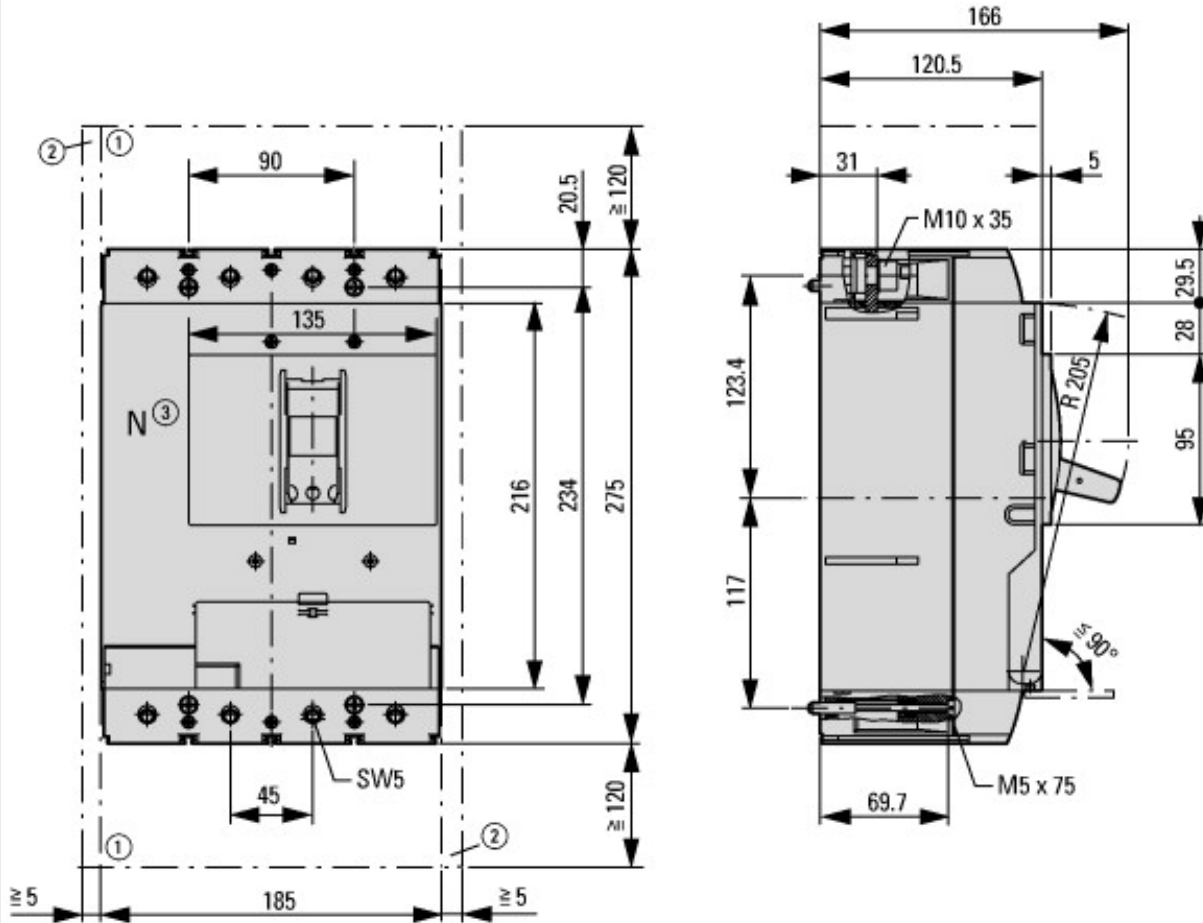

- ① Blow out area, minimum clearance to adjacent parts
- ② Minimum clearance to adjacent parts

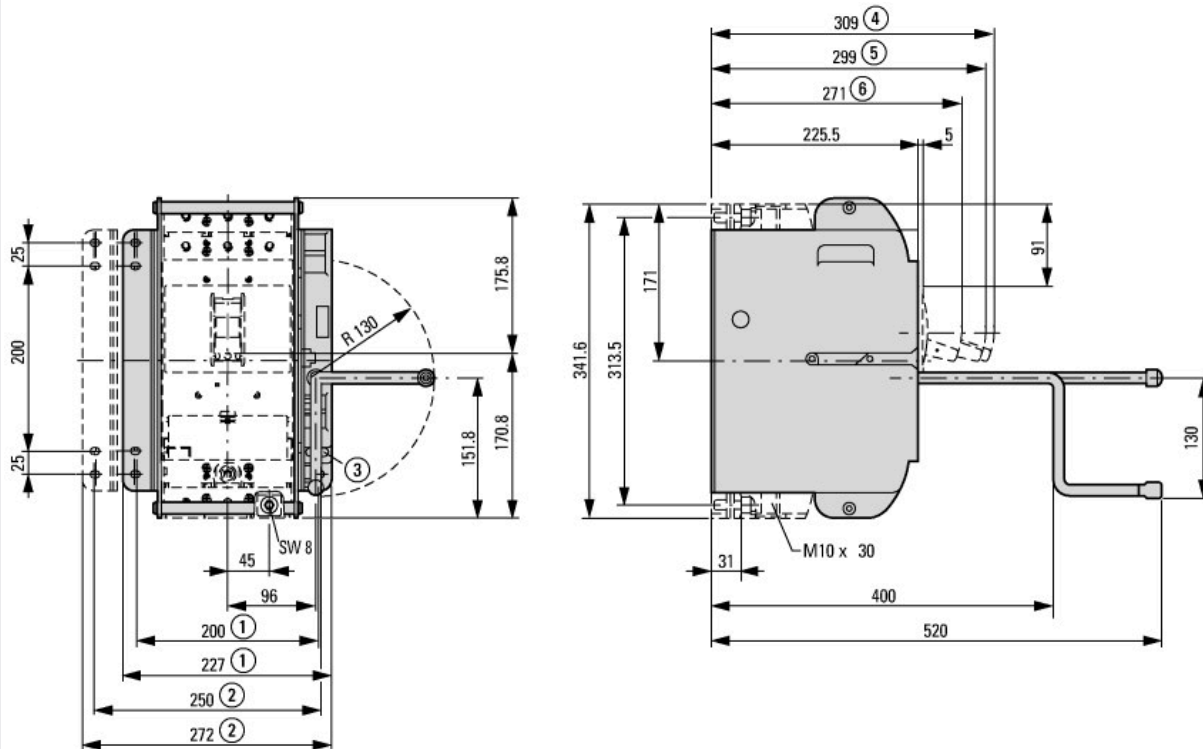

Additional product information (links)

IL01208009Z (AWA1230-1992) Circuit-Breaker, basic unit

IL01208009Z (AWA1230-1992) Circuit-Breaker, basic unit ftp://ftp.moeller.net/DOCUMENTATION/AWA_INSTRUCTIONS/IL01208009Z2018_11.pdf

Temperature dependency, Derating <http://ecat.moeller.net/flip-cat/?edition=HPLEN&startpage=17.172>

CurveSelect characteristics program <http://www.eaton.eu/DE/Europe/Electrical/CustomersSupport/ConfigurationTools/CharacteristicsProgram/index.htm>

