







**Circuit-breaker, 3p, 250A, +residual current circuit-breaker, 30mA, AC/DC sensitive**



**Part no. NZMH2-A250-FIA30**  
**Catalog No. 112629**

Similar to illustration

## Delivery program

Product range				Circuit-breaker
Protective function				System and cable protection, fire protection, personnel protection
Standard/Approval				IEC
Installation type				Fixed
Release system				Thermomagnetic release, AC/DC sensitive earth-fault release
Construction size				NZM2
Description				For equipment with power electronics, such as inverters and variable frequency drives Ready-to-connect combination consisting of type B circuit-breaker and residual current circuit-breaker and type A passive section Suitability for the application in three-phase systems without neutral conductor Personnel protection and preventive fire protection for 0 - 100 kHz fault current frequency Operational voltage range Type B 50 - 400 V AC (+ 10 %) Type A functionality even without operational voltage for rated frequency of 50 Hz Not UL/CSA approved Adjusting buttons can be sealed. Rated operating voltage 400 V AC (+/- 10 %) Rated frequency 50 Hz Rated fault current $I_{\Delta n} = 0.03$ A Depending on the cable manufacturer up to 240 mm <sup>2</sup> can be connected
Number of poles				3 pole
Standard equipment				Screw connection
Rated operational voltage	U <sub>e</sub>	V AC		400
<b>Switching capacity</b>				
400/415 V 50 Hz	I <sub>cu</sub>	kA		150
<b>Rated current = rated uninterrupted current</b>				
Rated current = rated uninterrupted current	I <sub>n</sub> = I <sub>u</sub>	A		250
<b>Setting range</b>				
Overload trip				
	I <sub>r</sub>	A		200 - 250
Short-circuit releases				
				
Non-delayed	I <sub>i</sub> = I <sub>n</sub> x ...			6 - 10
				
Short-circuit releases	I <sub>rm</sub>	A		1500 - 2500
				

## Technical data

<b>General</b>				
Standards				IEC/EN 60947, VDE 0660, EN 62423: Type B
Protection against direct contact				Finger and back of hand proof to VDE 0106 Part 100
Climatic proofing				Damp heat, constant, to IEC 60068-2-78 Damp heat, cyclic, to IEC 60068-2-30

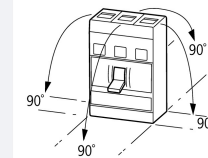
Ambient temperature			
Ambient temperature, storage	°C		- 40 - + 70
Operation	°C		-25 - +70
Mechanical shock resistance (10 ms half-sinusoidal shock) according to IEC 60068-2-27	g		20 (half-sinusoidal shock 20 ms)
Safe isolation to EN 61140			
Between auxiliary contacts and main contacts	V AC		500
between the auxiliary contacts	V AC		300
Weight	kg		2.345
Mounting position			Vertical and 90° in all directions  <p>With XFI earth-fault release:</p> <ul style="list-style-type: none"> <li>- NZM1, N1, NZM2, N2: vertical and 90° in all directions with plug-in unit</li> <li>- NZM1, N1, NZM2, N2: vertical, 90° right/left with withdrawable unit:</li> <li>- NZM3, N3: vertical, 90° right/left</li> <li>- NZM4, N4: vertical with remote operator:</li> <li>- NZM2, N(S)2, NZM3, N(S)3, NZM4, N(S)4: vertical and 90° in all directions</li> </ul>
Direction of incoming supply			bottom
Degree of protection			
Device			In the operating controls area: IP20 (basic degree of protection)
Enclosures			With insulating surround: IP40 With door coupling rotary handle: IP66
Terminations			Tunnel terminal: IP10 Phase isolator and strip terminal: IP00
Other technical data (sheet catalogue)			Temperature dependency, Derating

### Circuit-breakers

Rated current = rated uninterrupted current	$I_n = I_u$	A	250
Rated surge voltage invariability			
Main contacts	$U_{imp}$	V	8000
Auxiliary contacts		V	6000
Rated operational voltage	$U_e$	V AC	400
Overvoltage category/pollution degree			III/3
Rated insulation voltage	$U_i$	V	1000
Use in unearthed supply systems		V	≤ 400

### Switching capacity

Rated short-circuit making capacity			
240 V	$I_{cm}$	kA	330
400/415 V	$I_{cm}$	kA	330
Rated short-circuit breaking capacity $I_{cn}$			
Icu to IEC/EN 60947 test cycle O-t-CO			
240 V 50/60 Hz	$I_{cu}$	kA	150
400/415 V 50/60 Hz	$I_{cu}$	kA	150
Ics to IEC/EN 60947 test cycle O-t-CO-t-CO			
240 V 50/60 Hz	$I_{cs}$	kA	150
400/415 V 50/60 Hz	$I_{cs}$	kA	150
Maximum back-up fuse, if the expected short-circuit currents at the installation location exceed the switching capacity of the circuit-breaker.			
Rated short-time withstand current			
t = 0.3 s	$I_{cw}$	kA	1.9
t = 1 s	$I_{cw}$	kA	1.9
Utilization category to IEC/EN 60947-2			A
Lifespan, mechanical(of which max. 50 % trip by shunt/undervoltage release)	Operations		20000
Lifespan, electrical			
AC-1			
400 V 50/60 Hz	Operations		10000

415 V 50/60 Hz	Operations	10000
AC--3		
400 V 50/60 Hz	Operations	6500
415 V 50/60 Hz	Operations	6500
Max. operating frequency	Ops/h	120
Total break time at short-circuit	ms	< 10

### Terminal capacity

Standard equipment			Screw connection
Optional accessories			Box terminal Tunnel terminal connection on rear
Round copper conductor			
Box terminal			
Solid		mm <sup>2</sup>	1 x (10 - 16) 2 x (6 - 16)
Stranded		mm <sup>2</sup>	1 x (25 - 185) 2 x (25 - 70)
Tunnel terminal			
Solid		mm <sup>2</sup>	1 x 16
Stranded			
1-hole		mm <sup>2</sup>	1 x (25 - 185)
Bolt terminal and rear-side connection			
Direct on the switch			
Solid		mm <sup>2</sup>	1 x (10 - 16) 2 x (6 - 16)
Stranded		mm <sup>2</sup>	1 x (25 - 185) 2 x (25 - 70)
Al circular conductor			
Tunnel terminal			
Solid		mm <sup>2</sup>	1 x 16
Stranded			
Stranded		mm <sup>2</sup>	1 x (25 - 185)
Cu strip (number of segments x width x segment thickness)			
Box terminal			
	min.	mm	2 x 9 x 0.8
	max.	mm	10 x 16 x 0.8 (2x) 8 x 15.5 x 0,8
Bolt terminal and rear-side connection			
Flat copper strip, with holes	min.	mm	2 x 16 x 0.8
Flat copper strip, with holes	max.	mm	10 x 24 x 0.8
Copper busbar (width x thickness)		mm	
Bolt terminal and rear-side connection			
Screw connection			M8
Direct on the switch			
	min.	mm	16 x 5
	max.	mm	24 x 8
Control cables			
		mm <sup>2</sup>	1 x (0.75 - 2.5) 2 x (0.75 - 1.5)

### Design verification as per IEC/EN 61439

Technical data for design verification			
Rated operational current for specified heat dissipation	I <sub>n</sub>	A	250
Equipment heat dissipation, current-dependent	P <sub>vid</sub>	W	58.13
Operating ambient temperature min.		°C	-25
Operating ambient temperature max.		°C	70
IEC/EN 61439 design verification			
10.2 Strength of materials and parts			

10.2.2 Corrosion resistance		Meets the product standard's requirements.
10.2.3.1 Verification of thermal stability of enclosures		Meets the product standard's requirements.
10.2.3.2 Verification of resistance of insulating materials to normal heat		Meets the product standard's requirements.
10.2.3.3 Verification of resistance of insulating materials to abnormal heat and fire due to internal electric effects		Meets the product standard's requirements.
10.2.4 Resistance to ultra-violet (UV) radiation		Meets the product standard's requirements.
10.2.5 Lifting		Does not apply, since the entire switchgear needs to be evaluated.
10.2.6 Mechanical impact		Does not apply, since the entire switchgear needs to be evaluated.
10.2.7 Inscriptions		Meets the product standard's requirements.
10.3 Degree of protection of ASSEMBLIES		Does not apply, since the entire switchgear needs to be evaluated.
10.4 Clearances and creepage distances		Meets the product standard's requirements.
10.5 Protection against electric shock		Does not apply, since the entire switchgear needs to be evaluated.
10.6 Incorporation of switching devices and components		Does not apply, since the entire switchgear needs to be evaluated.
10.7 Internal electrical circuits and connections		Is the panel builder's responsibility.
10.8 Connections for external conductors		Is the panel builder's responsibility.
10.9 Insulation properties		
10.9.2 Power-frequency electric strength		Is the panel builder's responsibility.
10.9.3 Impulse withstand voltage		Is the panel builder's responsibility.
10.9.4 Testing of enclosures made of insulating material		Is the panel builder's responsibility.
10.10 Temperature rise		The panel builder is responsible for the temperature rise calculation. Eaton will provide heat dissipation data for the devices.
10.11 Short-circuit rating		Is the panel builder's responsibility. The specifications for the switchgear must be observed.
10.12 Electromagnetic compatibility		Is the panel builder's responsibility. The specifications for the switchgear must be observed.
10.13 Mechanical function		The device meets the requirements, provided the information in the instruction leaflet (IL) is observed.

## Technical data ETIM 7.0

Low-voltage industrial components (EG000017) / Power circuit-breaker for trafo/generator/installation protection (EC000228)		
Electric engineering, automation, process control engineering / Low-voltage switch technology / Circuit breaker (LV < 1 kV) / Circuit breaker for power transformer, generator and system protection (ecl@ss10.0.1-27-37-04-09 [AJZ716013])		
Rated permanent current I <sub>u</sub>	A	250
Rated voltage	V	690 - 690
Rated short-circuit breaking capacity I <sub>cu</sub> at 400 V, 50 Hz	kA	150
Overload release current setting	A	200 - 250
Adjustment range short-term delayed short-circuit release	A	0 - 0
Adjustment range undelayed short-circuit release	A	1500 - 2500
Integrated earth fault protection		No
Type of electrical connection of main circuit		Screw connection
Device construction		Built-in device fixed built-in technique
Suitable for DIN rail (top hat rail) mounting		No
DIN rail (top hat rail) mounting optional		Yes
Number of auxiliary contacts as normally closed contact		0
Number of auxiliary contacts as normally open contact		0
Number of auxiliary contacts as change-over contact		0
With switched-off indicator		No
With under voltage release		No
Number of poles		3
Position of connection for main current circuit		Front side
Type of control element		Rocker lever
Complete device with protection unit		Yes
Motor drive integrated		No
Motor drive optional		Yes
Degree of protection (IP)		IP20

# Characteristics





Let-through current

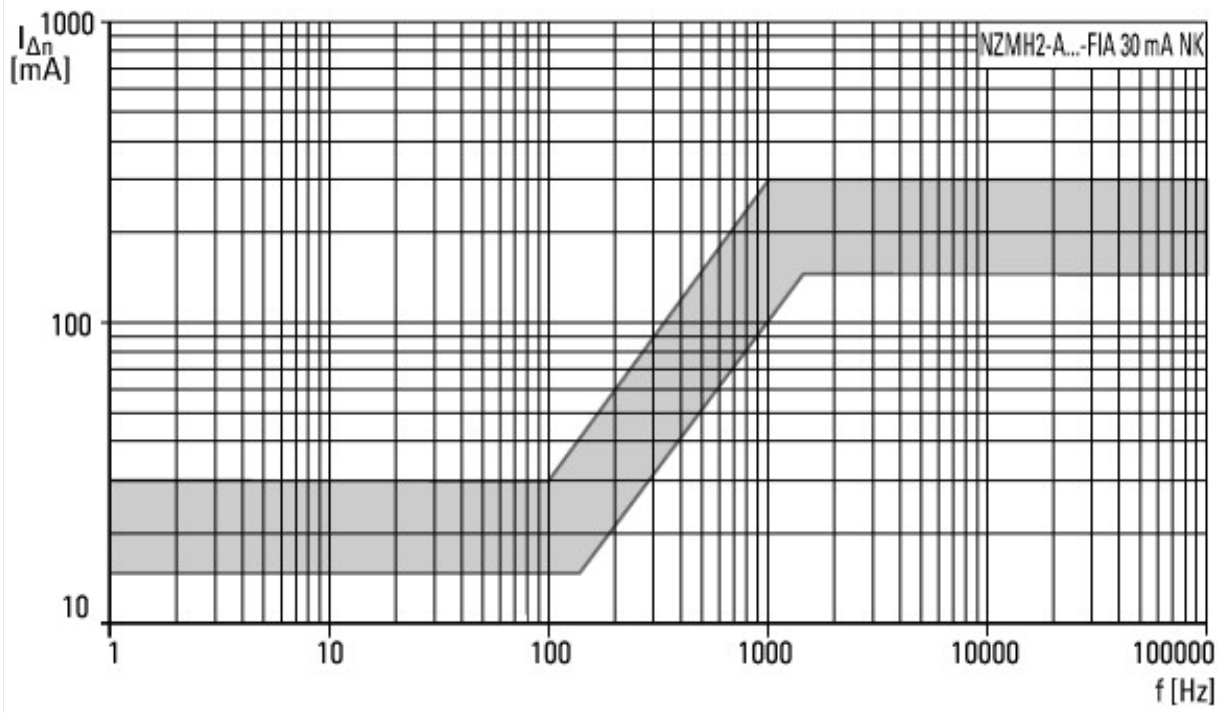

Let-through energy

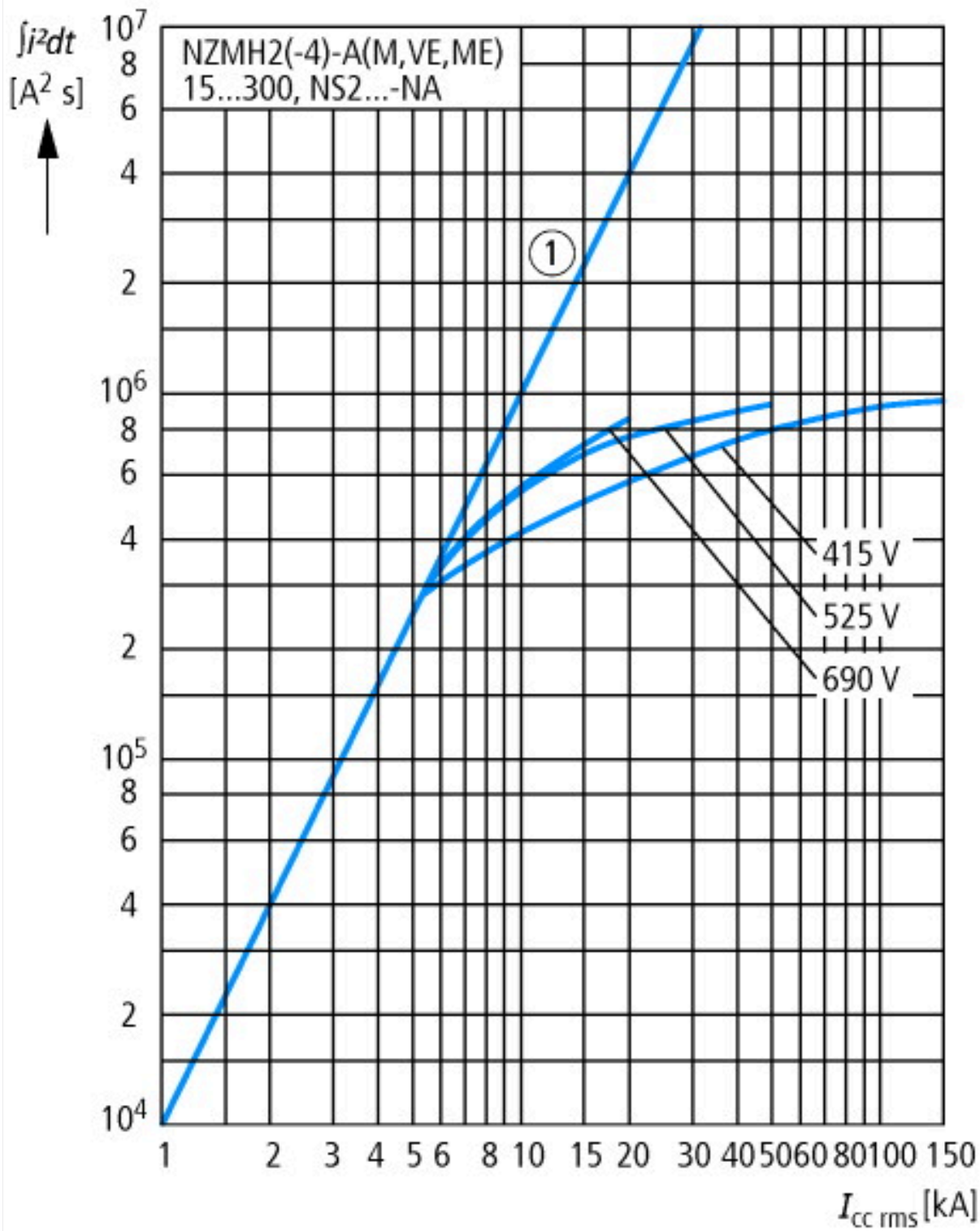



# Dimensions

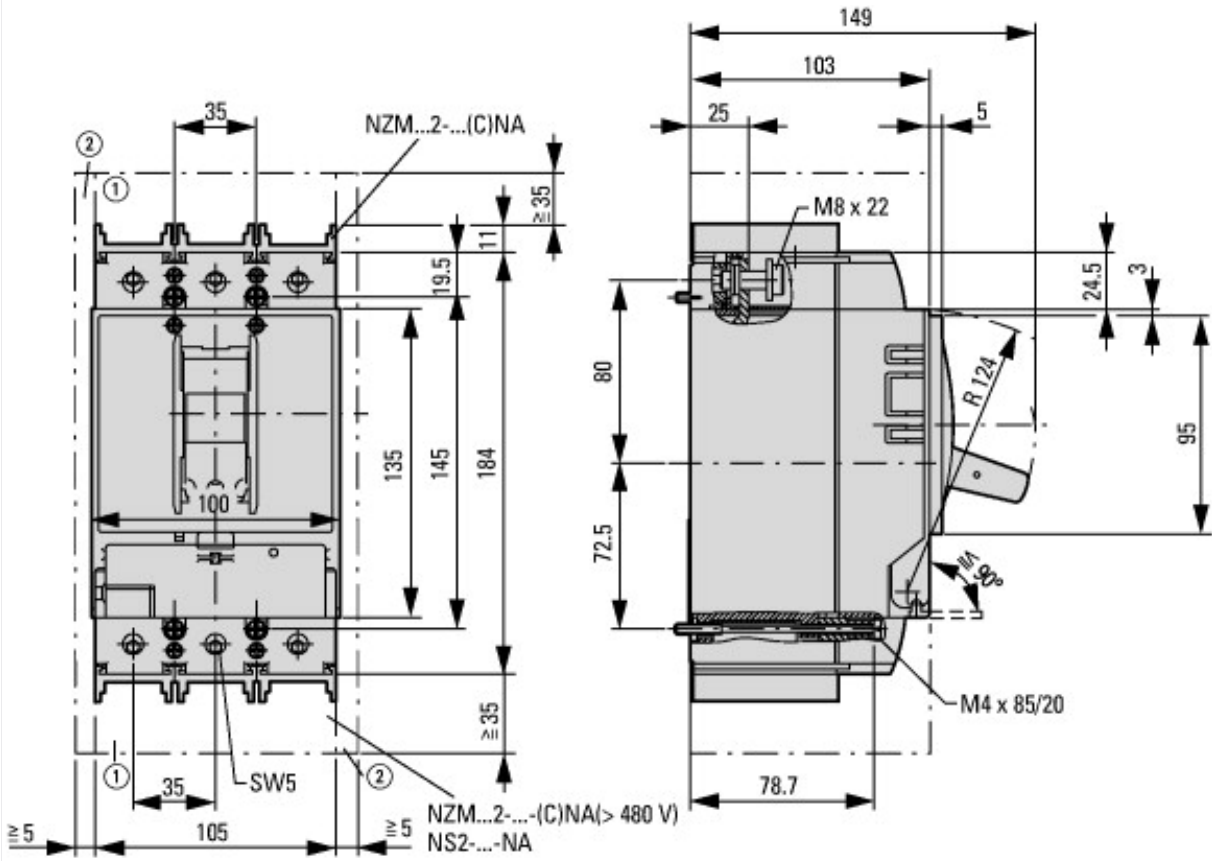

- ① Blow out area, minimum clearance to adjacent parts
- ② Minimum clearance to adjacent parts

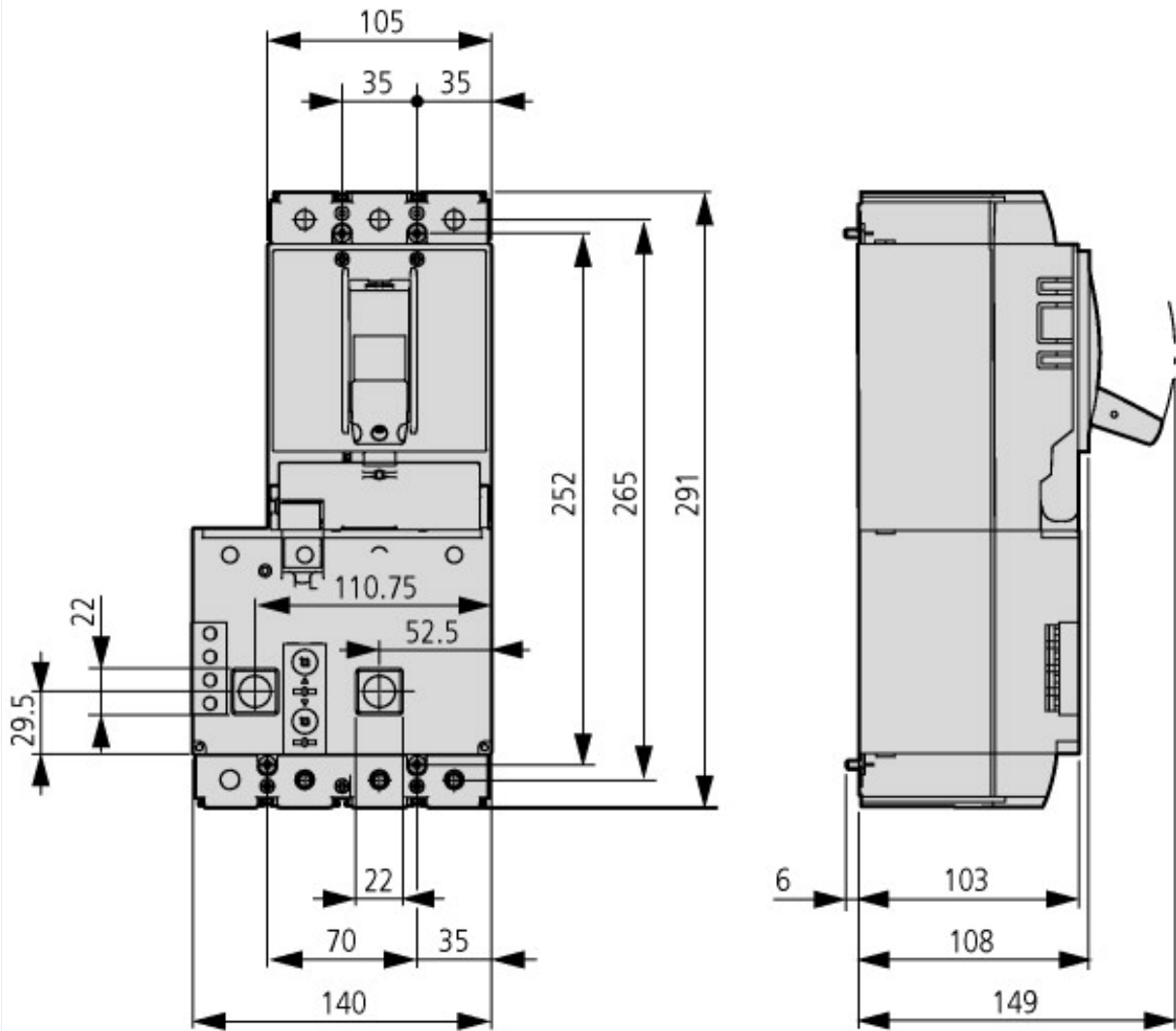

## Additional product information (links)

### IL01219040Z Residual current device with 3 pole NZM2, AC/DC

IL01219040Z Residual current device with 3 pole NZM2, AC/DC	<a href="ftp://ftp.moeller.net/DOCUMENTATION/AWA_INSTRUCTIONS/IL01219040Z2017_03.pdf">ftp://ftp.moeller.net/DOCUMENTATION/AWA_INSTRUCTIONS/IL01219040Z2017_03.pdf</a>
Temperature dependency, Derating	<a href="http://ecat.moeller.net/flip-cat/?edition=HPLEN&amp;startpage=17.172">http://ecat.moeller.net/flip-cat/?edition=HPLEN&amp;startpage=17.172</a>
CurveSelect characteristics program	<a href="http://www.eaton.eu/DE/Europe/Electrical/CustomerSupport/ConfigurationTools/CharacteristicsProgram/index.htm">http://www.eaton.eu/DE/Europe/Electrical/CustomerSupport/ConfigurationTools/CharacteristicsProgram/index.htm</a>
additional technical information for NZM power switch	<a href="ftp://ftp.moeller.net/DOCUMENTATION/PDF/nzm_technic_de_en.pdf">ftp://ftp.moeller.net/DOCUMENTATION/PDF/nzm_technic_de_en.pdf</a>