





Circuit-breaker, 3p, 110A, box terminals

Part no. **NZMN2-AF110-BT-NA**
 Catalog No. **107644**

Similar to illustration

Delivery program

Product range				Circuit-breaker
Protective function				System and cable protection
Standard/Approval				UL/CSA, IEC
Release system				Thermomagnetic release
Installation type				Fixed
Description				Switches conform to UL/CSA as well as the IEC regulations. IEC switching performance values are contained on the rating plate. Fixed overload releases Ir
Frame size				NZM2
Number of poles				3 pole
Standard equipment				Box terminal
Switching capacity				
SCCR 480Y/277 V 60 Hz	I_{cu}	kA		35
SCCR 480 V 60 Hz	I_{cu}	kA		35
SCCR 600Y/347 V 60 Hz	I_{cu}	kA		25
Rated current = rated uninterrupted current				
Rated current = rated uninterrupted current	$I_n = I_u$	A		110
Setting range				
Overload trip				
	I_r	A		110 - 110
Short-circuit releases				
				
Non-delayed	$I_j = I_n \times \dots$			6 - 10
				

Technical data

General

Standards				IEC/EN 60947
Protection against direct contact				Finger and back of hand proof to VDE 0106 Part 100
Climatic proofing				Damp heat, constant, to IEC 60068-2-78 Damp heat, cyclic, to IEC 60068-2-30
Ambient temperature				
Ambient temperature, storage		°C		- 40 - + 70
Operation		°C		-25 - +70
Mechanical shock resistance (10 ms half-sinusoidal shock) according to IEC 60068-2-27		g		20 (half-sinusoidal shock 20 ms)
Safe isolation to EN 61140				
Between auxiliary contacts and main contacts		V AC		500
between the auxiliary contacts		V AC		300
Weight		kg		2.345
Mounting position				
Mounting position				Vertical and 90° in all directions



With XFI earth-fault release:

- NZM1, N1, NZM2, N2: vertical and 90° in all directions with plug-in unit
- NZM1, N1, NZM2, N2: vertical, 90° right/left with withdrawable unit:
- NZM3, N3: vertical, 90° right/left
- NZM4, N4: vertical with remote operator:
- NZM2, N(S)2, NZM3, N(S)3, NZM4, N(S)4: vertical and 90° in all directions

Direction of incoming supply		as required
Degree of protection		
Device		In the operating controls area: IP20 (basic degree of protection)
Enclosures		With insulating surround: IP40 With door coupling rotary handle: IP66
Terminations		Tunnel terminal: IP10 Phase isolator and strip terminal: IP00
Other technical data (sheet catalogue)		Weight Temperature dependency, Derating Effective power loss

Circuit-breakers

Rated surge voltage invariability	U_{imp}		
Main contacts		V	8000
Auxiliary contacts		V	6000
Rated operational voltage	U_e	V AC	690
Overvoltage category/pollution degree			III/3
Rated insulation voltage	U_i	V	1000
Use in unearthed supply systems		V	≤ 690

Switching capacity

Rated short-circuit making capacity	I_{cm}		
240 V	I_{cm}	kA	187
400/415 V	I_{cm}	kA	105
440 V 50/60 Hz	I_{cm}	kA	74
525 V 50/60 Hz	I_{cm}	kA	53
690 V 50/60 Hz	I_c	kA	40
Rated short-circuit breaking capacity I_{cn}	I_{cn}		
I_{cu} to IEC/EN 60947 test cycle O-t-CO	I_{cu}	kA	
240 V 50/60 Hz	I_{cu}	kA	85
400/415 V 50/60 Hz	I_{cu}	kA	50
440 V 50/60 Hz	I_{cu}	kA	35
525 V 50/60 Hz	I_{cu}	kA	25
690 V 50/60 Hz	I_{cu}	kA	20
I_{cs} to IEC/EN 60947 test cycle O-t-CO-t-CO	I_{cs}	kA	
240 V 50/60 Hz	I_{cs}	kA	85
400/415 V 50/60 Hz	I_{cs}	kA	50
440 V 50/60 Hz	I_{cs}	kA	35
525 V 50/60 Hz	I_{cs}	kA	25
690 V 50/60 Hz	I_{cs}	kA	5
Maximum low-voltage h.b.c. fuse		A gG/gL	355
			Maximum back-up fuse, if the expected short-circuit currents at the installation location exceed the switching capacity of the circuit-breaker.
Technical data that diverge from products for the IEC market			
Switching capacity of NA switches (UL489, CSA 22.2 No. 5.1)			
Short-circuit current rating SCCR			
SCCR 240 V 60 Hz	I_{cu}	kA	85
SCCR 480V/277 V 60 Hz	I_{cu}	kA	35
SCCR 480 V 60 Hz	I_{cu}	kA	35
SCCR 600V/347 V 60 Hz	I_{cu}	kA	25

Rated short-time withstand current			
t = 0.3 s	I _{cw}	kA	1.9
t = 1 s	I _{cw}	kA	1.9
Utilization category to IEC/EN 60947-2			A
Lifespan, mechanical(of which max. 50 % trip by shunt/undervoltage release)			Operations 20000
Lifespan, electrical			
AC-1			
400 V 50/60 Hz	Operations		10000
690 V 50/60 Hz	Operations		7500
AC--3			
400 V 50/60 Hz	Operations		6500
415 V 50/60 Hz	Operations		6500
690 V 50/60 Hz	Operations		5000
Max. operating frequency		Ops/h	120
Total break time at short-circuit			ms < 10

Terminal capacity

Standard equipment				Box terminal
Round copper conductor				
Box terminal				
Solid		mm ²	1 x (12 ... 6)	
Stranded		mm ²	1 x (4 ... 350)	
Tunnel terminal				
Solid		mm ²	1 x 16	
Stranded				
Stranded		mm ²	1 x (4 ... 350)	
Bolt terminal and rear-side connection				
Direct on the switch				
Solid		mm ²	1 x (11 ... 6)	
Stranded		mm ²	1 x (4 ... 3/0)	
Al conductors, Cu cable				
Tunnel terminal				
Solid		mm ²	1 x 16	
Bolt terminal and rear-side connection				
Flat copper strip, with holes	min.	mm	2 x 16 x 0.8	
Flat copper strip, with holes	max.	mm	10 x 16 x 0.8	
Cu strip (number of segments x width x segment thickness)				
Box terminal				
	min.	mm	2 x 9 x 0.8	
	max.	mm	10 x 16 x 0.8	
Bolt terminal and rear-side connection				
Flat copper strip, with holes	min.	mm	2 x 16 x 0.8	
Flat copper strip, with holes	max.	mm	10 x 16 x 0.8	
Copper busbar (width x thickness)				
Bolt terminal and rear-side connection				
Screw connection			M8	
Direct on the switch				
	min.	mm	16 x 5	
	max.	mm	20 x 5	
Control cables				
		mm ²	1 x (18 ... 14) 2 x (18 ... 16)	

Design verification as per IEC/EN 61439

Technical data for design verification			
--	--	--	--

Rated operational current for specified heat dissipation	I _n	A	110
Equipment heat dissipation, current-dependent	P _{vid}	W	21.38
Operating ambient temperature min.		°C	-25
Operating ambient temperature max.		°C	70
IEC/EN 61439 design verification			
10.2 Strength of materials and parts			
10.2.2 Corrosion resistance			Meets the product standard's requirements.
10.2.3.1 Verification of thermal stability of enclosures			Meets the product standard's requirements.
10.2.3.2 Verification of resistance of insulating materials to normal heat			Meets the product standard's requirements.
10.2.3.3 Verification of resistance of insulating materials to abnormal heat and fire due to internal electric effects			Meets the product standard's requirements.
10.2.4 Resistance to ultra-violet (UV) radiation			Meets the product standard's requirements.
10.2.5 Lifting			Does not apply, since the entire switchgear needs to be evaluated.
10.2.6 Mechanical impact			Does not apply, since the entire switchgear needs to be evaluated.
10.2.7 Inscriptions			Meets the product standard's requirements.
10.3 Degree of protection of ASSEMBLIES			Does not apply, since the entire switchgear needs to be evaluated.
10.4 Clearances and creepage distances			Meets the product standard's requirements.
10.5 Protection against electric shock			Does not apply, since the entire switchgear needs to be evaluated.
10.6 Incorporation of switching devices and components			Does not apply, since the entire switchgear needs to be evaluated.
10.7 Internal electrical circuits and connections			Is the panel builder's responsibility.
10.8 Connections for external conductors			Is the panel builder's responsibility.
10.9 Insulation properties			
10.9.2 Power-frequency electric strength			Is the panel builder's responsibility.
10.9.3 Impulse withstand voltage			Is the panel builder's responsibility.
10.9.4 Testing of enclosures made of insulating material			Is the panel builder's responsibility.
10.10 Temperature rise			The panel builder is responsible for the temperature rise calculation. Eaton will provide heat dissipation data for the devices.
10.11 Short-circuit rating			Is the panel builder's responsibility. The specifications for the switchgear must be observed.
10.12 Electromagnetic compatibility			Is the panel builder's responsibility. The specifications for the switchgear must be observed.
10.13 Mechanical function			The device meets the requirements, provided the information in the instruction leaflet (IL) is observed.

Technical data ETIM 7.0

Low-voltage industrial components (EG000017) / Power circuit-breaker for trafo/generator/installation protection (EC000228)			
Electric engineering, automation, process control engineering / Low-voltage switch technology / Circuit breaker (LV < 1 kV) / Circuit breaker for power transformer, generator and system protection (ecI@ss10.0.1-27-37-04-09 [AJZ716013])			
Rated permanent current I _u		A	110
Rated voltage		V	690 - 690
Rated short-circuit breaking capacity I _{cu} at 400 V, 50 Hz		kA	50
Overload release current setting		A	110 - 110
Adjustment range short-term delayed short-circuit release		A	0 - 0
Adjustment range undelayed short-circuit release		A	6 - 10
Integrated earth fault protection			No
Type of electrical connection of main circuit			Frame clamp
Device construction			Built-in device fixed built-in technique
Suitable for DIN rail (top hat rail) mounting			No
DIN rail (top hat rail) mounting optional			Yes
Number of auxiliary contacts as normally closed contact			0
Number of auxiliary contacts as normally open contact			0
Number of auxiliary contacts as change-over contact			0
With switched-off indicator			No
With under voltage release			No
Number of poles			3
Position of connection for main current circuit			Front side
Type of control element			Rocker lever

Complete device with protection unit		Yes
Motor drive integrated		No
Motor drive optional		Yes
Degree of protection (IP)		IP20

Approvals

Product Standards		UL 489; CSA-C22.2 No. 5-09; IEC 60947-2; CE marking
UL File No.		E31593
UL Category Control No.		DIVQ
CSA File No.		022086
CSA Class No.		1432-01
North America Certification		UL listed, CSA certified
Specially designed for North America		Yes
Suitable for		Feeder circuits, branch circuits
Current Limiting Circuit-Breaker		Yes
Max. Voltage Rating		600Y/347 V, 480 V
Degree of Protection		IEC: IP20; UL/CSA Type: -

Characteristics



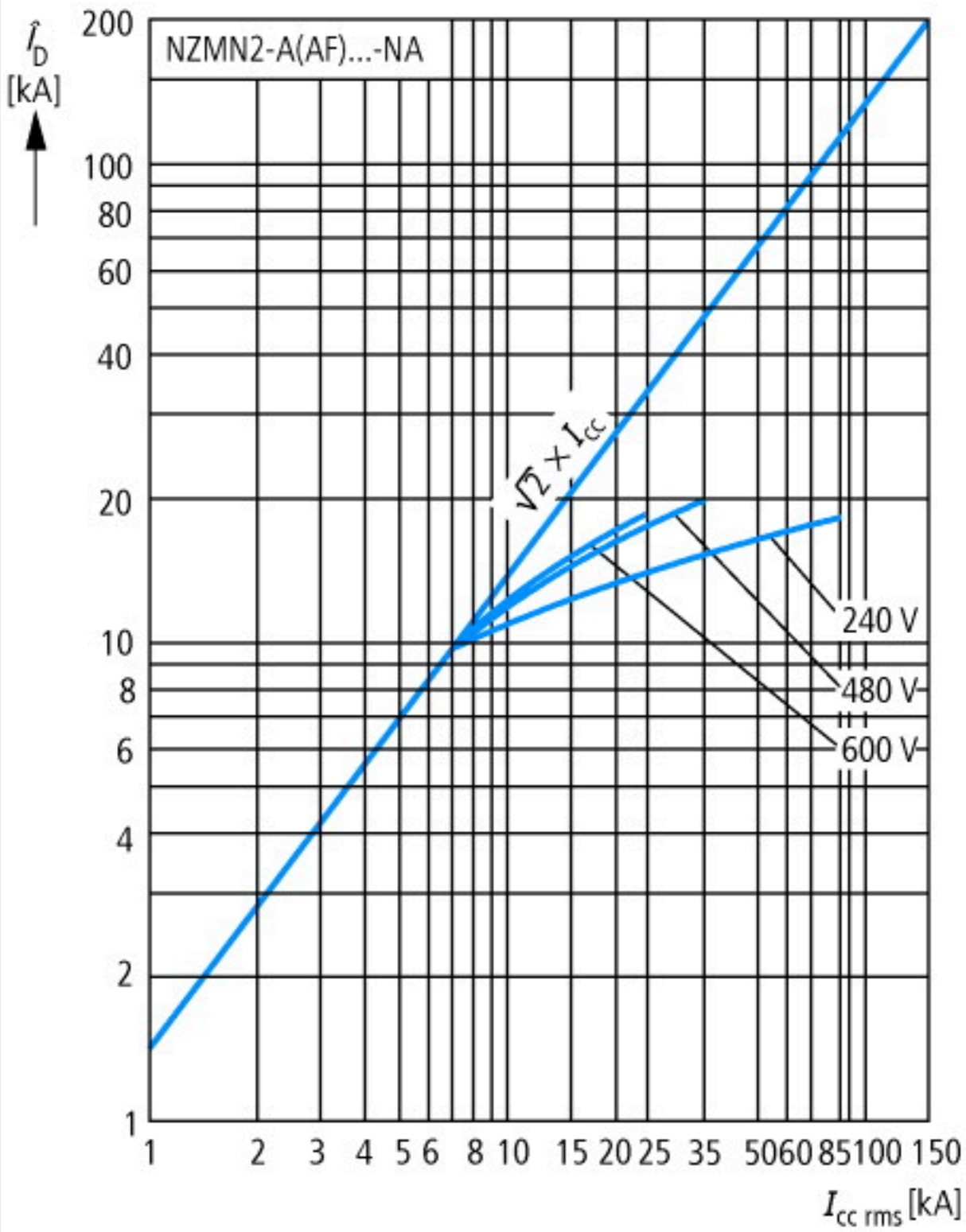



Dimensions

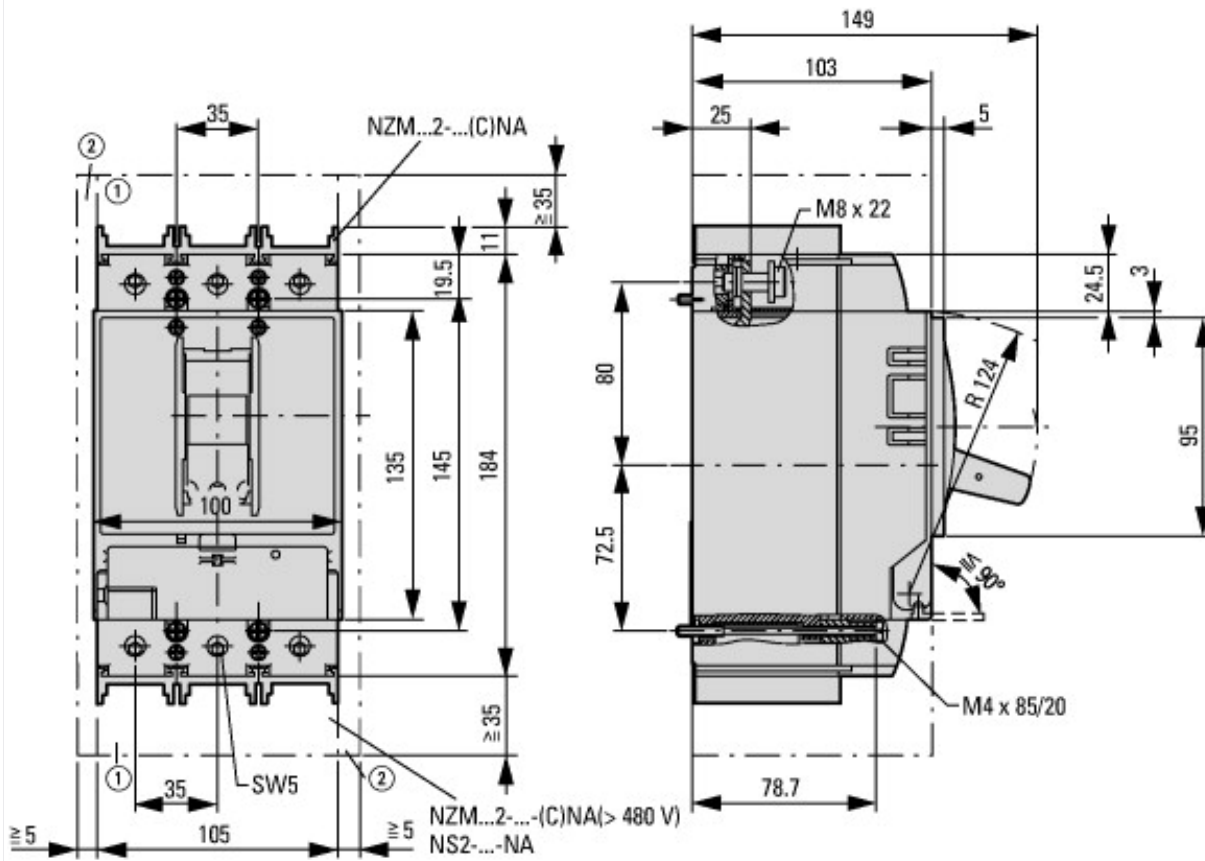

- ① Blow out area, minimum clearance to adjacent parts
- ② Minimum clearance to adjacent parts



Additional product information (links)

IL01206006Z (AWA1230-1916) Circuit-Breaker, basic unit

IL01206006Z (AWA1230-1916) Circuit-Breaker, basic unit	ftp://ftp.moeller.net/DOCUMENTATION/AWA_INSTRUCTIONS/IL01206006Z2015_11.pdf
Weight	http://ecat.moeller.net/flip-cat/?edition=HPLEN&startpage=17.171
Temperature dependency, Derating	http://ecat.moeller.net/flip-cat/?edition=HPLEN&startpage=17.172
Effective power loss	http://ecat.moeller.net/flip-cat/?edition=HPLEN&startpage=17.174
additional technical information for NZM power switch	ftp://ftp.moeller.net/DOCUMENTATION/PDF/nzm_techinc_de_en.pdf