







Circuit-breaker, 3p, 160A 1000V

Part no. NZMH2-VE160-S1
Catalog No. 100778

EL-Nummer (Norway) 0004359044

Similar to illustration

Delivery program

Product range			Circuit-breaker
Protective function			Systems, cable, selectivity and generator protection
Standard/Approval			IEC
Installation type			Fixed
Release system			Electronic release
Construction size			NZM2
Description			R.m.s. value measurement and "thermal memory" adjustable time delay setting to overcome current peaks tr: 2 – 20 s at 6 x I _r also infinity (without overload releases) Adjustable delay time tsd: Steps: 0, 20, 60, 100, 200, 300, 500, 750, 1000 ms i ² t constant function: fixed OFF NZM...S1 terminal type: NZM...XKSA cover required
Number of poles			3 pole
Standard equipment			Screw connection
Rated current = rated uninterrupted current	I _n = I _u	A	160
Switching capacity			
1000 V 50/60 Hz	I _{cu}	kA	10
Setting range			
Overload trip			
	I _r	A	80 - 160
Short-circuit releases			
			
Non-delayed	I _i = I _n x ...		1920 A fixed
			
Delayed	I _{sd} = I _r x ...		2 - 10
			

Technical data

Circuit-breakers

Rated surge voltage invariability	U _{imp}		
Main contacts		V	8000
Auxiliary contacts		V	6000
Rated operational voltage	U _e	V AC	1000
Rated current = rated uninterrupted current	I _n = I _u	A	160
Overvoltage category/pollution degree			III/3
Rated insulation voltage	U _i	V	1000
Utilization category			A
Ambient temperature			
Ambient temperature, storage		°C	- 40 - + 70
Operation		°C	-25 - +70

Rated short-circuit making capacity

240 V 50/60 Hz	I _{cm}	kA	330
----------------	-----------------	----	-----

400/415 V 50/60 Hz	I _{cm}	kA	330
440 V 50/60 Hz	I _{cm}	kA	286
525 V 50/60 Hz	I _{cm}	kA	105
690 V 50/60 H	I _c	kA	40
1000 V 50/60 Hz	I _{cm}	kA	17

Rated short-circuit breaking capacity I_{cn}

I _{cu} to IEC/EN 60947 test cycle O-t-CO	I _{cu}	kA	
240 V 50/60 Hz	I _{cu}	kA	150
400/415 V 50 Hz	I _{cu}	kA	150
440 V 50/60 Hz	I _{cu}	kA	130
525 V 50/60 Hz	I _{cu}	kA	50
690 V 50/60 Hz	I _{cu}	kA	20
1000 V 50/60 Hz	I _{cu}	kA	10
I _{cs} to IEC/EN 60947 test cycle O-t-CO-t-CO	I _{cs}	kA	
230 V 50/60 Hz	I _{cs}	kA	150
400/415 V 50/60 Hz	I _{cs}	kA	150
440 V 50/60 Hz	I _{cs}	kA	130
525 V 50/60 Hz	I _{cs}	kA	37.5
690 V 50/60 Hz	I _{cs}	kA	5
1000 V AC	I _{cs}	kA	3

Rated short-time withstand current

t = 0.3 s	I _{cw}	kA	1.9
t = 1 s	I _{cw}	kA	1.9
Lifespan, mechanical	Operations		20000
Max. operating frequency		Ops/h	120
			Lifespan, mechanical: of which max. 50 % trip by shunt/undervoltage release

Lifespan, electrical

1000 V 50/60 Hz	Operations		3000
-----------------	------------	--	------

Terminal capacity

Standard equipment			Screw connection
Round copper conductor			
Box terminal			
Solid		mm ²	1 x (10 - 16) 2 x (6-16)
Stranded		mm ²	1 x (25 - 185) 2 x (25-70)
Tunnel terminal			
Solid		mm ²	1 x 16
Stranded			
Stranded		mm ²	1 x (25 - 185)
Bolt terminal and rear-side connection			
Direct on the switch			
Solid		mm ²	1 x (10 - 16) 2 x (10 - 16)
Stranded		mm ²	1 x (25 - 50) 2 x (25 - 50)
Al conductors, Cu cable			
Tunnel terminal			
Solid		mm ²	1 x 16
Stranded			
Stranded		mm ²	1 x (25 - 185) ²⁾
			²⁾ Up to 240 mm ² can be connected depending on the cable manufacturer.
Cu strip (number of segments x width x segment thickness)			
Box terminal			
	min.	mm	2 x 9 x 0.8
	max.	mm	10 x 16 x 0.8

			(2x) 8 x 15.5 x 0,8
Bolt terminal and rear-side connection			
Flat copper strip, with holes	min.	mm	2 x 16 x 0.8
Flat copper strip, with holes	max.	mm	10 x 24 x 0.8
Copper busbar (width x thickness)	mm		
Bolt terminal and rear-side connection			
Screw connection			M8
Direct on the switch			
	min.	mm	16 x 5
	max.	mm	24 x 8
Control cables			
		mm ²	1 x (0.75 - 2.5) 2 x (0.75 - 1.5)

Design verification as per IEC/EN 61439

Technical data for design verification			
Rated operational current for specified heat dissipation	I _n	A	160
Equipment heat dissipation, current-dependent	P _{vid}	W	21.12
Operating ambient temperature min.		°C	-25
Operating ambient temperature max.		°C	70
IEC/EN 61439 design verification			
10.2 Strength of materials and parts			
10.2.2 Corrosion resistance			Meets the product standard's requirements.
10.2.3.1 Verification of thermal stability of enclosures			Meets the product standard's requirements.
10.2.3.2 Verification of resistance of insulating materials to normal heat			Meets the product standard's requirements.
10.2.3.3 Verification of resistance of insulating materials to abnormal heat and fire due to internal electric effects			Meets the product standard's requirements.
10.2.4 Resistance to ultra-violet (UV) radiation			Meets the product standard's requirements.
10.2.5 Lifting			Does not apply, since the entire switchgear needs to be evaluated.
10.2.6 Mechanical impact			Does not apply, since the entire switchgear needs to be evaluated.
10.2.7 Inscriptions			Meets the product standard's requirements.
10.3 Degree of protection of ASSEMBLIES			Does not apply, since the entire switchgear needs to be evaluated.
10.4 Clearances and creepage distances			Meets the product standard's requirements.
10.5 Protection against electric shock			Does not apply, since the entire switchgear needs to be evaluated.
10.6 Incorporation of switching devices and components			Does not apply, since the entire switchgear needs to be evaluated.
10.7 Internal electrical circuits and connections			Is the panel builder's responsibility.
10.8 Connections for external conductors			Is the panel builder's responsibility.
10.9 Insulation properties			
10.9.2 Power-frequency electric strength			Is the panel builder's responsibility.
10.9.3 Impulse withstand voltage			Is the panel builder's responsibility.
10.9.4 Testing of enclosures made of insulating material			Is the panel builder's responsibility.
10.10 Temperature rise			The panel builder is responsible for the temperature rise calculation. Eaton will provide heat dissipation data for the devices.
10.11 Short-circuit rating			Is the panel builder's responsibility. The specifications for the switchgear must be observed.
10.12 Electromagnetic compatibility			Is the panel builder's responsibility. The specifications for the switchgear must be observed.
10.13 Mechanical function			The device meets the requirements, provided the information in the instruction leaflet (IL) is observed.

Technical data ETIM 7.0

Low-voltage industrial components (EG000017) / Power circuit-breaker for trafo/generator/installation protection (EC000228)			
Electric engineering, automation, process control engineering / Low-voltage switch technology / Circuit breaker (LV < 1 kV) / Circuit breaker for power transformer, generator and system protection (ecI@ss10.0.1-27-37-04-09 [AJZ716013])			
Rated permanent current I _u		A	160
Rated voltage		V	1000 - 1000
Rated short-circuit breaking capacity I _{cu} at 400 V, 50 Hz		kA	150
Overload release current setting		A	80 - 160

Adjustment range short-term delayed short-circuit release	A	160 - 1600
Adjustment range undelayed short-circuit release	A	1920 - 1920
Integrated earth fault protection		No
Type of electrical connection of main circuit		Screw connection
Device construction		Built-in device fixed built-in technique
Suitable for DIN rail (top hat rail) mounting		No
DIN rail (top hat rail) mounting optional		Yes
Number of auxiliary contacts as normally closed contact		0
Number of auxiliary contacts as normally open contact		0
Number of auxiliary contacts as change-over contact		0
With switched-off indicator		No
With under voltage release		No
Number of poles		3
Position of connection for main current circuit		Front side
Type of control element		Rocker lever
Complete device with protection unit		Yes
Motor drive integrated		No
Motor drive optional		Yes
Degree of protection (IP)		IP20

Characteristics

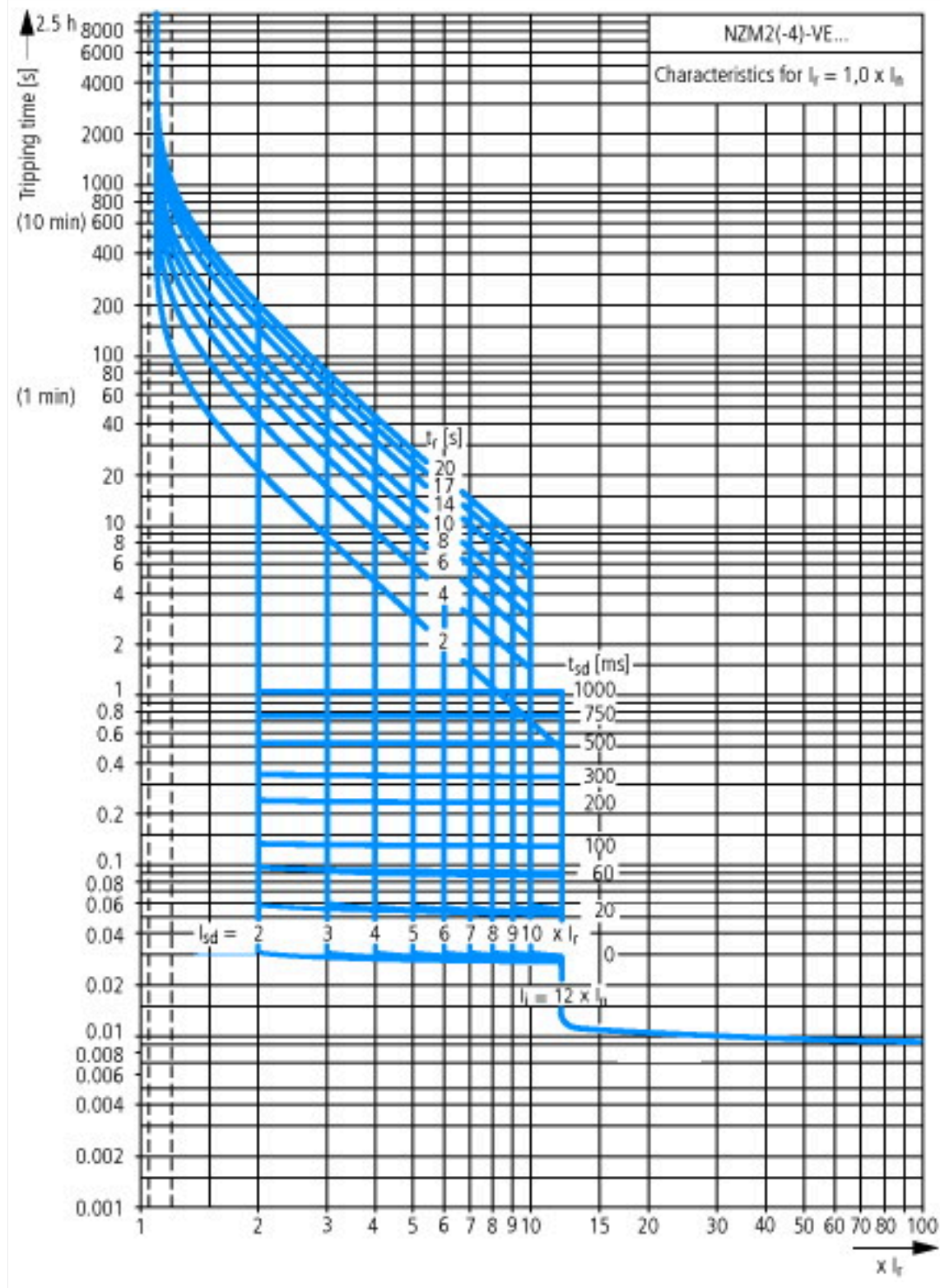



Let-through current



Let-through energy

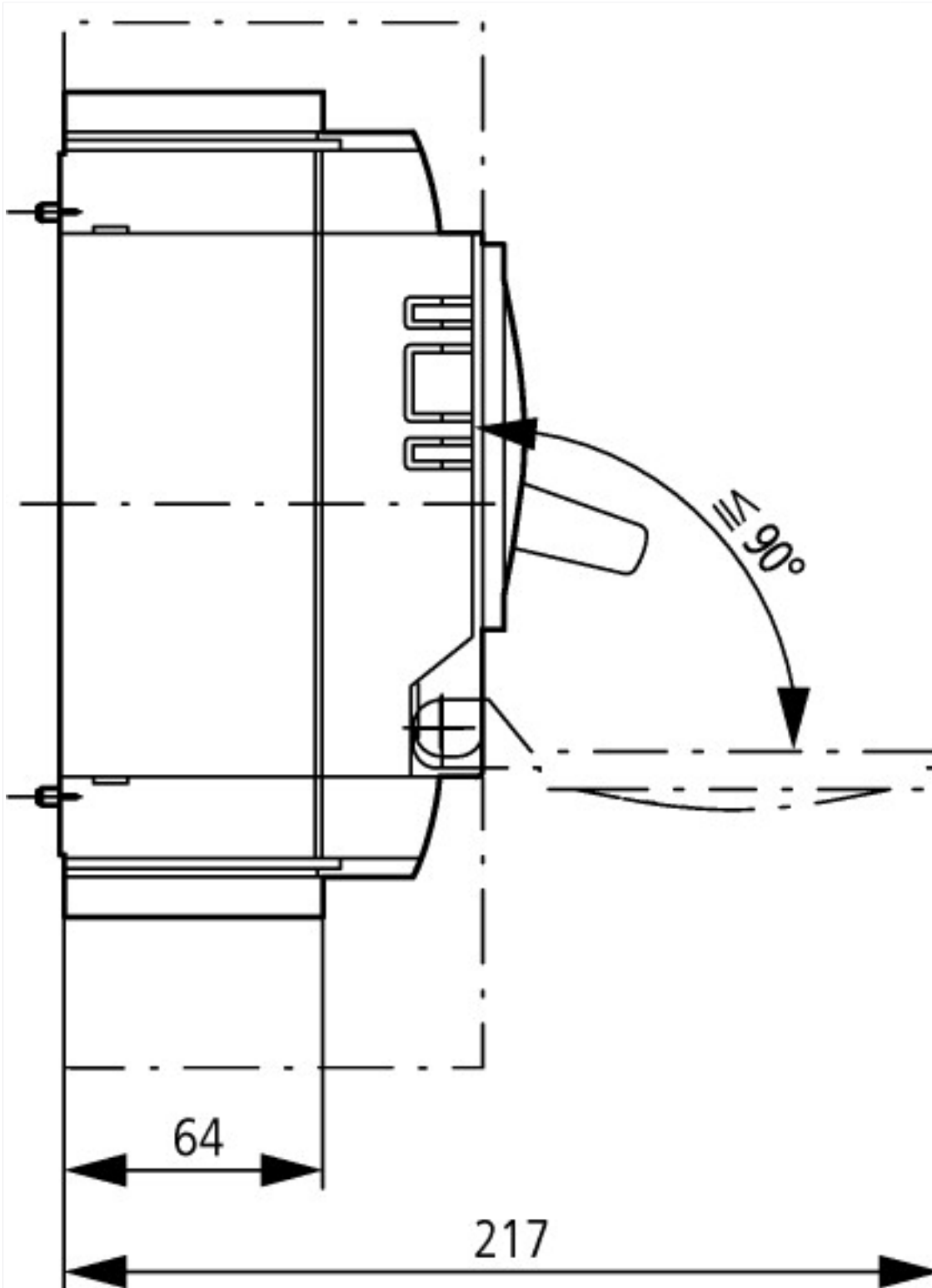

Additional product information (links)

IL01206006Z (AWA1230-1916) Circuit-Breaker, basic unit

IL01206006Z (AWA1230-1916) Circuit-Breaker, basic unit	ftp://ftp.moeller.net/DOCUMENTATION/AWA_INSTRUCTIONS/IL01206006Z2015_11.pdf
Weight	http://ecat.moeller.net/flip-cat/?edition=HPLEN&startpage=17.171
Temperature dependency, Derating	http://ecat.moeller.net/flip-cat/?edition=HPLEN&startpage=17.172
Effective power loss	http://ecat.moeller.net/flip-cat/?edition=HPLEN&startpage=17.174
Selectivity, Back Up Protection and Coordination Guide	http://www.eaton.eu/ecm/groups/public/@pub/@europe/@electrical/documents/content/pct_1198913.pdf
Setting-Specific Representation of Tripping Characteristics and Competent Assessment of their Interaction	http://www.moeller.net/binary/ver_techpapers/ver943en.pdf
Busbar Component Adapters for modern Industrial control panels	http://www.moeller.net/binary/ver_techpapers/ver960en.pdf
CurveSelect characteristics program	http://www.eaton.eu/DE/Europe/Electrical/CustomerSupport/ConfigurationTools/CharacteristicsProgram/index.htm

Eaton configurator	http://www.eaton.eu/DE/Europe/Electrical/CustomerSupport/ConfigurationTools/ConfiguratorCircuitBreaker/index.htm
additional technical information for NZM power switch	ftp://ftp.moeller.net/DOCUMENTATION/PDF/nzm_technic_de_en.pdf