



**Illuminated selector switch actuator, maintained/momentary, 45° 45°, 25 × 25 mm, 3 positions, With thumb-grip, White, with VS anti-rotation tab, without light elements, With base, W2x4,6d; max. 30 V, 1 W**



**Part no. Q25LWK3R1-WS**  
**Catalog No. 072364**  
**Alternate Catalog No. Q25LWK3R1-WS**

## Delivery program

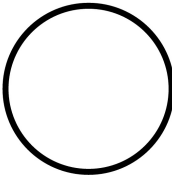
Product range			RMQ16
Basic function			Illuminated selector switch actuator
Single unit/Complete unit			Single unit
Design			With thumb-grip maintained/momentary
<b>Function:</b>			
Description			45°  45° with VS anti-rotation tab without light elements With base, W2x4,6d; max. 30 V, 1 W 3 positions
<b>Colour</b>			
Thumb-grip			White 
Degree of Protection			IP65
Connection to SmartWire-DT			no
Front dimensions			25 × 25 mm

## Technical data

<b>General</b>			
Standards			IEC/EN 60947
Lifespan, mechanical	Operations	x 10 <sup>6</sup>	> 3
Operating frequency	Operations/h		≤ 1800
Operating torque		Nm	≤ 0.2
Degree of protection, IEC/EN 60529			IP65
Climatic proofing			Damp heat, constant, to IEC 60068-2-78 Damp heat, cyclic, to IEC 60068-2-30
Ambient temperature			
Open		°C	-25 - +60
Enclosed		°C	- 25 - 40
Mounting position			As required
Mechanical shock resistance		g	> 40 according to IEC 60068-2-27 Shock duration 11 ms Sinusoidal
Terminal capacities		mm <sup>2</sup>	0.5 - 1.0
Blade terminal			2.8 × 0.8 mm to DIN 46244
Fast-on connectors			2.8 × 0.8 mm to DIN 46247 and IEC 60760
<b>Contacts</b>			
Rated impulse withstand voltage	U <sub>imp</sub>	V AC	800
Rated insulation voltage	U <sub>i</sub>	V	250
Overvoltage category/pollution degree			III/3

Rated operational voltage	U <sub>e</sub>	V AC	24
Control circuit reliability			
at 24 V DC/5 mA	H <sub>F</sub>	Fault probability	< 10 <sup>-7</sup> (i.e. 1 failure to 10 <sup>7</sup> operations)
at 5 V DC/1 mA	H <sub>F</sub>	Fault probability	< 5 x 10 <sup>-6</sup> (1 failure in 5 x 10 <sup>6</sup> operations)
Use of insulated ferrule ISH 2,8			>24 V AC/DC recommended >50 V AC or 120 V DC is mandatory, even on unused blade terminals

## Design verification as per IEC/EN 61439

Technical data for design verification			
Rated operational current for specified heat dissipation	I <sub>n</sub>	A	0
Heat dissipation per pole, current-dependent	P <sub>vid</sub>	W	0
Equipment heat dissipation, current-dependent	P <sub>vid</sub>	W	0
Static heat dissipation, non-current-dependent	P <sub>vs</sub>	W	0
Heat dissipation capacity	P <sub>diss</sub>	W	0
Operating ambient temperature min.		°C	-25
Operating ambient temperature max.		°C	60
IEC/EN 61439 design verification			
10.2 Strength of materials and parts			
10.2.2 Corrosion resistance			
			Meets the product standard's requirements.
10.2.3.1 Verification of thermal stability of enclosures			
			Meets the product standard's requirements.
10.2.3.2 Verification of resistance of insulating materials to normal heat			
			Meets the product standard's requirements.
10.2.3.3 Verification of resistance of insulating materials to abnormal heat and fire due to internal electric effects			
			Meets the product standard's requirements.
10.2.4 Resistance to ultra-violet (UV) radiation			
			Please enquire
10.2.5 Lifting			
			Does not apply, since the entire switchgear needs to be evaluated.
10.2.6 Mechanical impact			
			Does not apply, since the entire switchgear needs to be evaluated.
10.2.7 Inscriptions			
			Meets the product standard's requirements.
10.3 Degree of protection of ASSEMBLIES			
			Does not apply, since the entire switchgear needs to be evaluated.
10.4 Clearances and creepage distances			
			Meets the product standard's requirements.
10.5 Protection against electric shock			
			Does not apply, since the entire switchgear needs to be evaluated.
10.6 Incorporation of switching devices and components			
			Does not apply, since the entire switchgear needs to be evaluated.
10.7 Internal electrical circuits and connections			
			Is the panel builder's responsibility.
10.8 Connections for external conductors			
			Is the panel builder's responsibility.
10.9 Insulation properties			
10.9.2 Power-frequency electric strength			
			Is the panel builder's responsibility.
10.9.3 Impulse withstand voltage			
			Is the panel builder's responsibility.
10.9.4 Testing of enclosures made of insulating material			
			Is the panel builder's responsibility.
10.10 Temperature rise			
			Not applicable.
10.11 Short-circuit rating			
			Is the panel builder's responsibility. The specifications for the switchgear must be observed.
10.12 Electromagnetic compatibility			
			Is the panel builder's responsibility. The specifications for the switchgear must be observed.
10.13 Mechanical function			
			The device meets the requirements, provided the information in the instruction leaflet (IL) is observed.

## Technical data ETIM 7.0

Low-voltage industrial components (EG000017) / Front element for selector switch (EC000222)			
Electric engineering, automation, process control engineering / Low-voltage switch technology / Command and alarm device / Front element for selector switches (ecl@ss10.0.1-27-37-12-13 [AKF031014])			
Number of switch positions			3
Type of control element			Toggle
Suitable for illumination			Yes
Colour control element			Black
Colour indicator light cap			White
Construction type lens			Square
Hole diameter		mm	16

Width opening	mm	0
Height opening	mm	0
Switching function latching		Yes
Spring-return		Yes
With front ring		Yes
Material front ring		Plastic
Colour front ring		Black
Degree of protection (IP), front side		IP65
Degree of protection (NEMA)		1

## Approvals

Product Standards		IEC/EN 60947-5; UL 508; CSA-C22.2 No. 14-05; CE marking
UL File No.		E29184
UL Category Control No.		NKCR
CSA File No.		46552
CSA Class No.		3211-03
North America Certification		UL listed, CSA certified
Degree of Protection		UL/CSA Type 1

## Dimensions

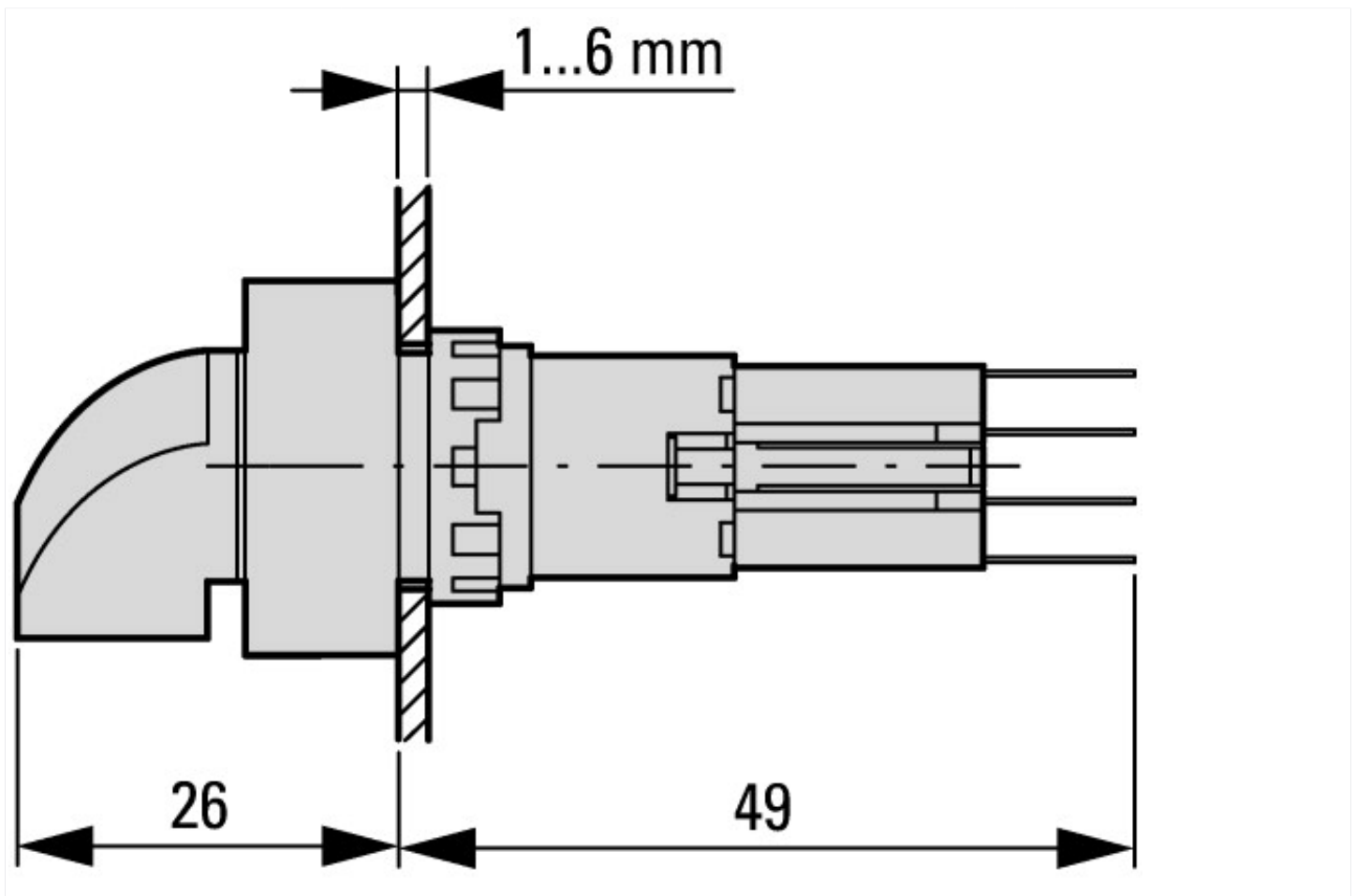

Actuating and indicator elements  
Square style

## Assets (links)

### Declaration of CE Conformity

00002898

### Instruction Leaflets

IL04716016Z2018\_05

## Additional product information (links)

[IL04716016Z \(AWA1160-1429\) Mounting of components](#)

