



Contactor, 42 V 50 Hz, 48 V 60 Hz, 3 pole, 380 V 400 V, 4 kW, Contacts N/C = Normally closed= 1 NC, Screw terminals, AC operation



Part no. **DILEM-01(42V50HZ,48V60HZ)**
 Catalog No. **051791**
 Alternate Catalog No. **XTMC9A01W**

Delivery program

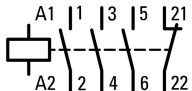
| | | | | |
|---|----------------|----|--|--|
| Product range | | | | Contactors |
| Application | | | | Mini Contactors for Motors and Resistive Loads |
| Subrange | | | | DILEM contactors |
| Utilization category | | | | AC-1: Non-inductive or slightly inductive loads, resistance furnaces AC-3/AC-3e: Normal AC induction motors: Starting, switching off while running AC-4: Normal AC induction motors: starting, plugging, reversing, inching |
| Notes | | | |  Also suitable for motors with efficiency class IE3. IE3-ready devices are identified by the logo on their packaging. Also tested according to AC-3e. |
| Connection technique | | | | Screw terminals |
| Description | | | | With auxiliary contact |
| Number of poles | | | | 3 pole |
| Rated operational current | | | | |
| AC-3 | | | | |
| 380 V 400 V | I_e | A | | 9 |
| AC-1 | | | | |
| Conventional free air thermal current, 3 pole, 50 - 60 Hz | | | | |
| Open | | | | |
| at 40 °C | $I_{th} = I_e$ | A | | 22 |
| Max. rating for three-phase motors, 50 - 60 Hz | | | | |
| AC-3 | | | | |
| 220 V 230 V | P | kW | | 2.2 |
| 380 V 400 V | P | kW | | 4 |
| 660 V 690 V | P | kW | | 4 |
| AC-4 | | | | |
| 220 V 230 V | P | kW | | 1.5 |
| 380 V 400 V | P | kW | | 3 |
| 660 V 690 V | P | kW | | 3 |
| Contacts | | | | |
| N/C = Normally closed | | | | 1 NC |
| Contact sequence | | | |  |
| For use with | | | | ...DILE |
| Actuating voltage | | | | 42 V 50 Hz, 48 V 60 Hz |
| Voltage AC/DC | | | | AC operation |

Technical data

| | | | | |
|-------------------------------------|------------|---------------|--|---------------------------------|
| General | | | | |
| Standards | | | | IEC/EN 60947, VDE 0660, CSA, UL |
| Lifespan, mechanical; Coil 50/60 Hz | Operations | $\times 10^6$ | | 7 |
| Lifespan, mechanical | Operations | $\times 10^6$ | | 10 |
| Maximum operating frequency | | | | |

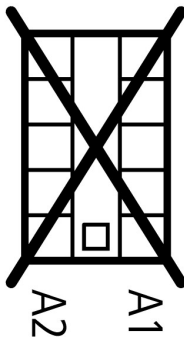
| | | |
|---|-----------------|--|
| Mechanical | Ops/h | 9000 |
| electrical (Contactors without overload relay) | Operations/h | Page 05/070 |
| Climatic proofing | | Damp heat, constant, to IEC 60068-2-78 Damp heat, cyclic, to IEC 60068-2-30 |
| Ambient temperature | | |
| Open | °C | -25 - +50 |
| Enclosed | °C | -25 - 40 |
| Storage | °C | |
| Min. ambient temperature, storage | °C | -40 |
| Ambient temperature, storage max. | °C | +80 |
| Mounting position | | As required, except vertical with terminals A1/A2 at the bottom |
| Mounting position | |  |
| Mechanical shock resistance (IEC/EN 60068-2-27) | | |
| Half-sinusoidal shock, 10 ms | | |
| Basic unit without auxiliary contact module | | |
| Main contacts, make contacts | g | 10 |
| Main contacts Make/break contacts | g | |
| Break contact | g | 10 |
| Basic unit with auxiliary contact module | | |
| Main contacts make contact | g | |
| Make | g | 10 |
| Auxiliary contacts Make/break contacts | g | 20 / 20 |
| Degree of Protection | | IP20 |
| Protection against direct contact when actuated from front (EN 50274) | | Finger and back-of-hand proof |
| Altitude | m | Max. 2000 |
| Weight | kg | 0.17 |
| Terminal capacity of auxiliary and main contacts | | |
| Screw terminals | | |
| Solid | mm ² | 1 x (0.75 - 2.5) 2 x (0.75 - 2.5) |
| Flexible with ferrule | mm ² | 1 x (0.75 - 1.5) 2 x (0.75 - 1.5) |
| Solid or stranded | AWG | 18 - 14 |
| Stripping length | mm | 8 |
| Terminal screw | | M3.5 |
| Pozidriv screwdriver | Size | 2 |
| Standard screwdriver | mm | 0.8 x 5.5 1 x 6 |
| Max. tightening torque | Nm | 1.2 |

Main conducting paths

| | | | |
|---|------------------|------|-------|
| Rated impulse withstand voltage | U _{imp} | V AC | 6000 |
| Overvoltage category/pollution degree | | | III/3 |
| Rated insulation voltage | U _i | V AC | 690 |
| Rated operational voltage | U _e | V AC | 690 |
| Safe isolation to EN 61140 | | | |
| between coil and contacts | | V AC | 300 |
| between the contacts | | V AC | 300 |
| Making capacity (cos φ to IEC/EN 60947) | | A | 110 |

| | | | |
|---------------------------------------|-------|---|----|
| Breaking capacity | | | |
| 220 V 230 V | | A | 90 |
| 380 V 400 V | | A | 90 |
| 500 V | | A | 64 |
| 660 V 690 V | | A | 42 |
| Short-circuit protection maximum fuse | | | |
| Type "2", 500 V | gL/gG | A | 10 |
| Type "1", 500 V | gL/gG | A | 20 |

AC

| | | | |
|---|----------------|----|---|
| AC-1 | | | |
| Rated operational current | | | |
| Conventional free air thermal current, 3 pole, 50 - 60 Hz | | | |
| Open | | | |
| at 40 °C | $I_{th} = I_e$ | A | 22 |
| at 50 °C | $I_{th} = I_e$ | A | 20 |
| at 55 °C | $I_{th} = I_e$ | A | 19 |
| enclosed | I_{th} | A | 16 |
| Notes | | | At maximum permissible ambient air temperature. |
| Conventional free air thermal current, 1 pole | | | |
| Notes | | | At maximum permissible ambient air temperature. |
| open | I_{th} | A | 50 |
| enclosed | I_{th} | A | 40 |
| AC-3 | | | |
| Rated operational current | | | |
| Open, 3-pole: 50 – 60 Hz | | | |
| Notes | | | At maximum permissible ambient temperature (open.) Also tested according to AC-3e. |
| 220 V 230 V | I_e | A | 9 |
| 240 V | I_e | A | 9 |
| 380 V 400 V | I_e | A | 9 |
| 415 V | I_e | A | 9 |
| 440V | I_e | A | 9 |
| 500 V | I_e | A | 6.4 |
| 660 V 690 V | I_e | A | 4.8 |
| Motor rating | | P | kWh |
| 220 V 230 V | P | kW | 2.2 |
| 240V | P | kW | 2.5 |
| 380 V 400 V | P | kW | 4 |
| 415 V | P | kW | 4.3 |
| 440 V | P | kW | 4.6 |
| 500 V | P | kW | 4 |
| 660 V 690 V | P | kW | 4 |
| AC-4 | | | |
| Rated operational current | | | |
| Open, 3-pole: 50 – 60 Hz | | | |
| Notes | | | At maximum permissible ambient air temperature. |
| 220 V 230 V | I_e | A | 6.6 |
| 240 V | I_e | A | 6.6 |
| 380 V 400 V | I_e | A | 6.6 |
| 415 V | I_e | A | 6.6 |
| 440 V | I_e | A | 6.6 |
| 500 V | I_e | A | 5 |
| 660 V 690 V | I_e | A | 3.4 |
| Motor rating | | P | kWh |

| | | | |
|-------------|---|----|-----|
| 220 V 230 V | P | kW | 1.5 |
| 240 V | P | kW | 1.8 |
| 380 V 400 V | P | kW | 3 |
| 415 V | P | kW | 3.1 |
| 440 V | P | kW | 3.3 |
| 500 V | P | kW | 3 |
| 660 V 690 V | P | kW | 3 |

DC

| | | | |
|--------------------------------|-------|---|----|
| Rated operational current open | | | |
| DC-1 | | | |
| 12 V | I_e | A | 20 |
| 24 V | I_e | A | 20 |
| 60 V | I_e | A | 20 |
| 110 V | I_e | A | 20 |
| 220 V | I_e | A | 20 |

Magnet systems

| | | | |
|--|---------|---------|-----------|
| Voltage tolerance | | | |
| AC operated | | | |
| Single-voltage coil 50 Hz and dual-voltage coil 50 Hz, 60 Hz | Pick-up | $x U_c$ | 0.8 - 1.1 |
| Dual-frequency coil 50/60 Hz | Pick-up | $x U_c$ | |
| Voltage tolerance Dual-frequency coil 50/60 Hz, max. pick-up voltage | | $x U_c$ | 1.1 |
| Power consumption | | | |
| AC operation | | | |
| Single-voltage coil 50 Hz and dual-voltage coil 50 Hz, 60 Hz | Pick-up | VA | 25 |
| Single-voltage coil 50 Hz and dual-voltage coil 50 Hz, 60 Hz | Pick-up | W | 22 |
| Single-voltage coil 50 Hz and dual-voltage coil 50 Hz, 60 Hz | Sealing | VA | 4.6 |
| Single-voltage coil 50 Hz and dual-voltage coil 50 Hz, 60 Hz | Sealing | W | 1.8 |
| Duty factor | | % DF | 100 |
| Switching times at 100 % U_c | | | |
| Make contact | | ms | |
| Closing delay | | ms | |
| Closing delay min. | | ms | 14 |
| Closing delay max. | | ms | 21 |
| Opening delay | | ms | |
| Opening delay min. | | ms | 8 |
| Opening delay max. | | ms | 18 |
| Closing delay with top mounting auxiliary contact | | ms | 45 |
| Reversing contactors | | | |
| Changeover time at 110 % U_c | | | |
| Changeover time min. | | ms | 16 |
| Changeover time max. | | ms | 21 |
| Arcing time at 690 V AC | | ms | 12 |

Current heat losses (3- or 4-pole)

| | | | |
|------------------------|--|----|------|
| at I_{th} , 50 °C | | W | 5.9 |
| at I_e to AC-3/400 V | | W | 1.2 |
| Impedance per pole | | mΩ | 9.18 |

Auxiliary contacts

| | | | |
|--|-----------|------|-------|
| Positive operating contacts to EN 60947-5-1 appendix L, including auxiliary contact module | | | Yes |
| Rated impulse withstand voltage | U_{imp} | V AC | 6000 |
| Overvoltage category/pollution degree | | | III/3 |
| Rated insulation voltage | U_i | V AC | 690 |
| Rated operational voltage | U_e | V AC | 600 |
| Safe isolation to EN 61140 | | | |
| between coil and auxiliary contacts | | V AC | 300 |

| | | | |
|---|--------------|---------------|--|
| between the auxiliary contacts | | V AC | 300 |
| Rated operational current | | | |
| AC-15 | | | |
| 220 V 240 V | I_e | A | 6 |
| 380 V 415 V | I_e | A | 3 |
| 500 V | I_e | A | 1.5 |
| DC L/R \leq 15 ms | | | |
| Contacts in series: | | A | |
| 1 | 24 V | A | 2.5 |
| 2 | 60 V | A | 2.5 |
| 3 | 100 V | A | 1.5 |
| 3 | 220 V | A | 0.5 |
| Conv. thermal current | I_{th} | A | 10 |
| Control circuit reliability | Failure rate | λ | $<10^{-8}$, < one failure at 100 million operations (at $U_e = 24$ V DC, $U_{min} = 17$ V, $I_{min} = 5.4$ mA) |
| Component lifespan at $U_e = 240$ V | | | |
| AC-15 | Operations | $\times 10^6$ | 0.2 |
| DC current | | | |
| L/R = 50 ms: 2 contacts in series at $I_e = 0.5$ A | Operations | $\times 10^6$ | 0.15 |
| Notes | | | Switch-on and switch-off conditions based on DC-13, time constant as specified |
| Short-circuit rating without welding | | | |
| Maximum overcurrent protective device | | | |
| Short-circuit protection only | | | PKZM0-4 |
| Short-circuit protection maximum fuse | | | |
| 500 V | | A gG/gL | 6 |
| 500 V | | A fast | 10 |
| Current heat loss at a load of I_{th} per contact | | W | 1.1 |
| Rating data for approved types | | | |
| Switching capacity | | | |
| Maximum motor rating | | | |
| Three-phase | | | |
| 200 V 208 V | | HP | 2 |
| 230 V 240 V | | HP | 3 |
| 460 V 480 V | | HP | 5 |
| 575 V 600 V | | HP | 5 |
| Single-phase | | | |
| 115 V 120 V | | HP | 0.5 |
| 230 V 240 V | | HP | 1.5 |
| General use | | A | 15 |
| Auxiliary contacts | | | |
| Pilot Duty | | | |
| AC operated | | | A600 |
| DC operated | | | P300 |
| General Use | | | |
| AC | | V | 600 |
| AC | | A | 10 |
| DC | | V | 250 |
| DC | | A | 0.5 |
| Short Circuit Current Rating | | SCCR | |
| Basic Rating | | | |
| SCCR | | kA | 5 |

| | | |
|-----------|---|----|
| max. Fuse | A | 45 |
|-----------|---|----|

Design verification as per IEC/EN 61439

| Technical data for design verification | | | |
|--|------------|----|-----|
| Rated operational current for specified heat dissipation | I_n | A | 9 |
| Heat dissipation per pole, current-dependent | P_{vid} | W | 0.4 |
| Equipment heat dissipation, current-dependent | P_{vid} | W | 1.2 |
| Static heat dissipation, non-current-dependent | P_{vs} | W | 1.8 |
| Heat dissipation capacity | P_{diss} | W | 0 |
| Operating ambient temperature min. | | °C | -25 |
| Operating ambient temperature max. | | °C | 50 |
| IEC/EN 61439 design verification | | | |
| 10.2 Strength of materials and parts | | | |
| 10.2.2 Corrosion resistance | | | |
| Meets the product standard's requirements. | | | |
| 10.2.3.1 Verification of thermal stability of enclosures | | | |
| Meets the product standard's requirements. | | | |
| 10.2.3.2 Verification of resistance of insulating materials to normal heat | | | |
| Meets the product standard's requirements. | | | |
| 10.2.3.3 Verification of resistance of insulating materials to abnormal heat and fire due to internal electric effects | | | |
| Meets the product standard's requirements. | | | |
| 10.2.4 Resistance to ultra-violet (UV) radiation | | | |
| Meets the product standard's requirements. | | | |
| 10.2.5 Lifting | | | |
| Does not apply, since the entire switchgear needs to be evaluated. | | | |
| 10.2.6 Mechanical impact | | | |
| Does not apply, since the entire switchgear needs to be evaluated. | | | |
| 10.2.7 Inscriptions | | | |
| Meets the product standard's requirements. | | | |
| 10.3 Degree of protection of ASSEMBLIES | | | |
| Does not apply, since the entire switchgear needs to be evaluated. | | | |
| 10.4 Clearances and creepage distances | | | |
| Meets the product standard's requirements. | | | |
| 10.5 Protection against electric shock | | | |
| Does not apply, since the entire switchgear needs to be evaluated. | | | |
| 10.6 Incorporation of switching devices and components | | | |
| Does not apply, since the entire switchgear needs to be evaluated. | | | |
| 10.7 Internal electrical circuits and connections | | | |
| Is the panel builder's responsibility. | | | |
| 10.8 Connections for external conductors | | | |
| Is the panel builder's responsibility. | | | |
| 10.9 Insulation properties | | | |
| 10.9.2 Power-frequency electric strength | | | |
| Is the panel builder's responsibility. | | | |
| 10.9.3 Impulse withstand voltage | | | |
| Is the panel builder's responsibility. | | | |
| 10.9.4 Testing of enclosures made of insulating material | | | |
| Is the panel builder's responsibility. | | | |
| 10.10 Temperature rise | | | |
| The panel builder is responsible for the temperature rise calculation. Eaton will provide heat dissipation data for the devices. | | | |
| 10.11 Short-circuit rating | | | |
| Is the panel builder's responsibility. The specifications for the switchgear must be observed. | | | |
| 10.12 Electromagnetic compatibility | | | |
| Is the panel builder's responsibility. The specifications for the switchgear must be observed. | | | |
| 10.13 Mechanical function | | | |
| The device meets the requirements, provided the information in the instruction leaflet (IL) is observed. | | | |

Technical data ETIM 7.0

| Low-voltage industrial components (EG000017) / Power contactor, AC switching (EC000066) | | | |
|---|--|----|---------|
| Electric engineering, automation, process control engineering / Low-voltage switch technology / Contactor (LV) / Power contactor, AC switching (ecl@ss10.0.1-27-37-10-03 [AAB718015]) | | | |
| Rated control supply voltage U_s at AC 50HZ | | V | 42 - 42 |
| Rated control supply voltage U_s at AC 60HZ | | V | 48 - 48 |
| Rated control supply voltage U_s at DC | | V | 0 - 0 |
| Voltage type for actuating | | | AC |
| Rated operation current I_e at AC-1, 400 V | | A | 22 |
| Rated operation current I_e at AC-3, 400 V | | A | 9 |
| Rated operation power at AC-3, 400 V | | kW | 4 |
| Rated operation current I_e at AC-4, 400 V | | A | 6.6 |
| Rated operation power at AC-4, 400 V | | kW | 3 |
| Rated operation power NEMA | | kW | 3.7 |
| Modular version | | | No |
| Number of auxiliary contacts as normally open contact | | | 0 |
| Number of auxiliary contacts as normally closed contact | | | 1 |

| | | |
|--|--|------------------|
| Type of electrical connection of main circuit | | Screw connection |
| Number of normally closed contacts as main contact | | 0 |
| Number of main contacts as normally open contact | | 3 |

Approvals

| | | |
|--------------------------------------|--|---|
| Product Standards | | IEC/EN 60947-4-1; UL 508; CSA-C22.2 No. 14-05; CE marking |
| UL File No. | | E29096 |
| UL Category Control No. | | NLDX |
| CSA File No. | | 012528 |
| CSA Class No. | | 3211-04 |
| North America Certification | | UL listed, CSA certified |
| Specially designed for North America | | No |

Characteristics

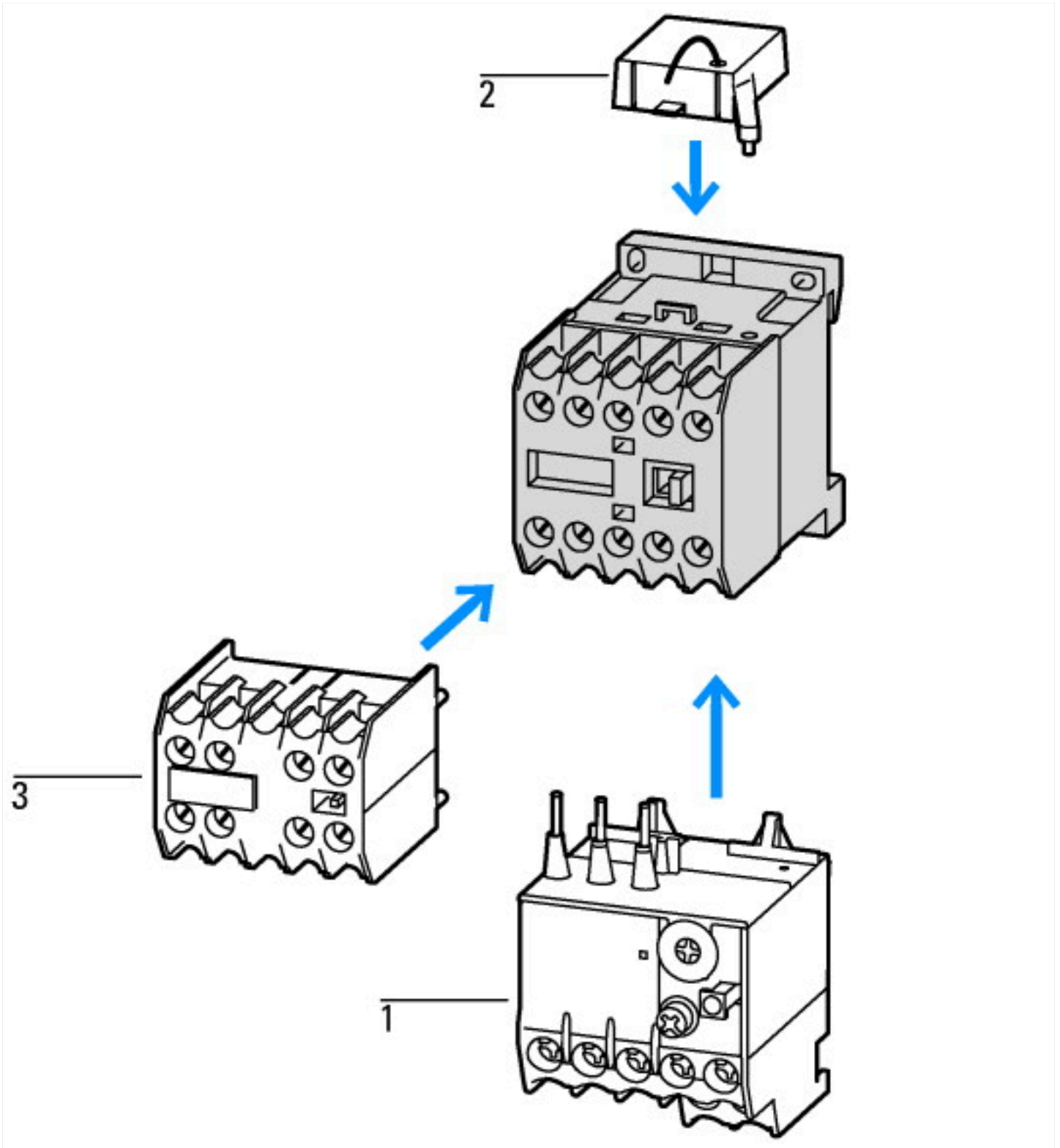

- 1: Overload relay
 - 2: Suppressor
 - 3: Auxiliary contact modules
- Enclosure totally insulated

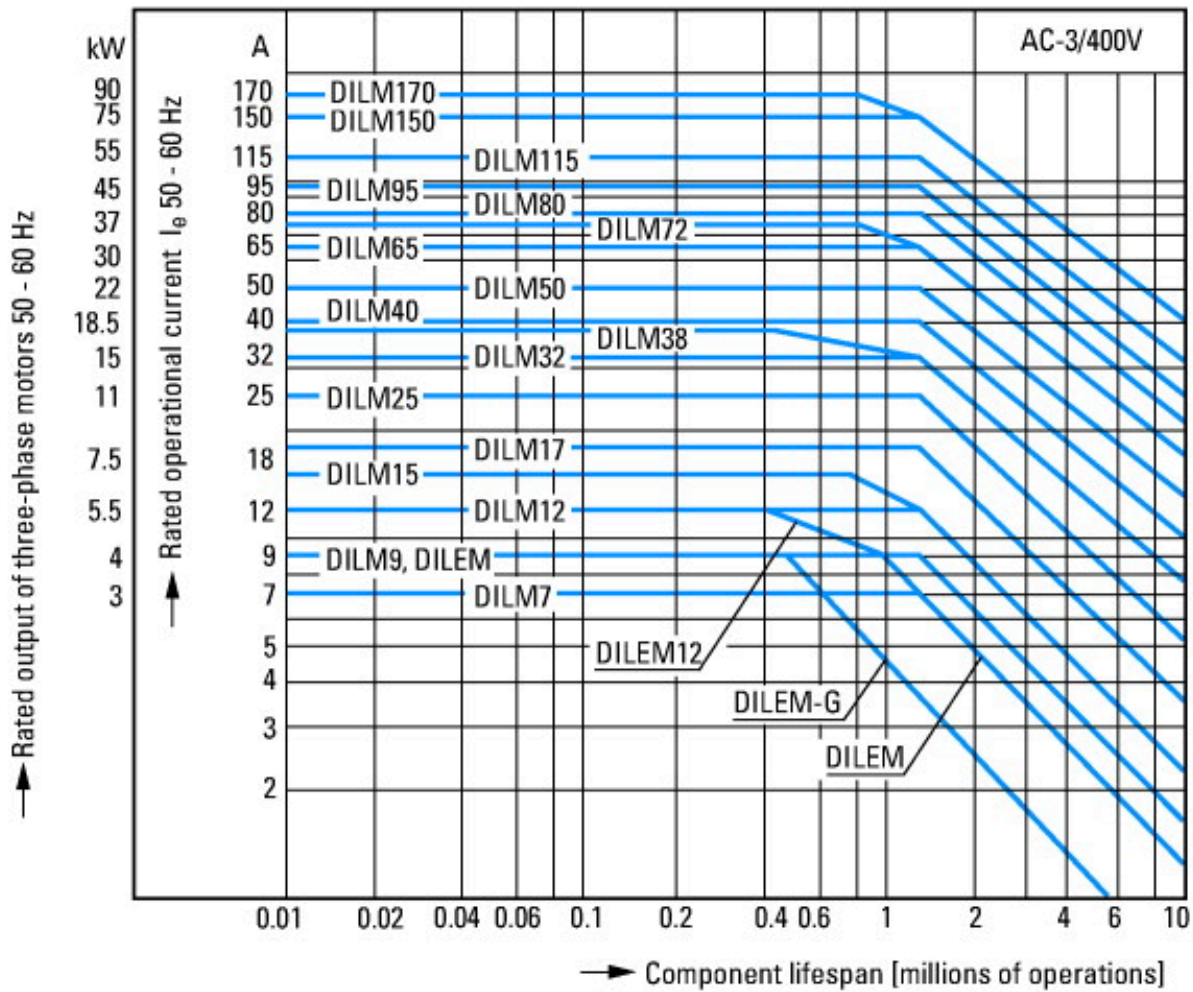

Squirrel-cage motor
 Operating characteristics
 Starting: from rest
 Stopping: after attaining full running speed
 Electrical characteristics
 Make: up to 6 x rated motor current
 Break: up to 1 x rated motor current
 Utilization category
 100 % AC-3
 Typical applications
 Compressors
 Lifts
 Mixers
 Pumps
 Escalators
 Agitators
 Fans
 Conveyor belts
 Centrifuges
 Hinged flaps
 Bucket-elevators
 Air conditioning system
 General drives in manufacturing and processing machines

Extreme switching duty
 Squirrel-cage motor
 Operating characteristics
 Inching, plugging, reversing
 Electrical characteristics
 Make: up to 6 x rated motor current
 Break: up to 6 x rated motor current
 Utilization category
 100 % AC-4
 Typical applications
 Printing presses
 Wire-drawing machines
 Centrifuges
 Special drives for manufacturing and processing machines

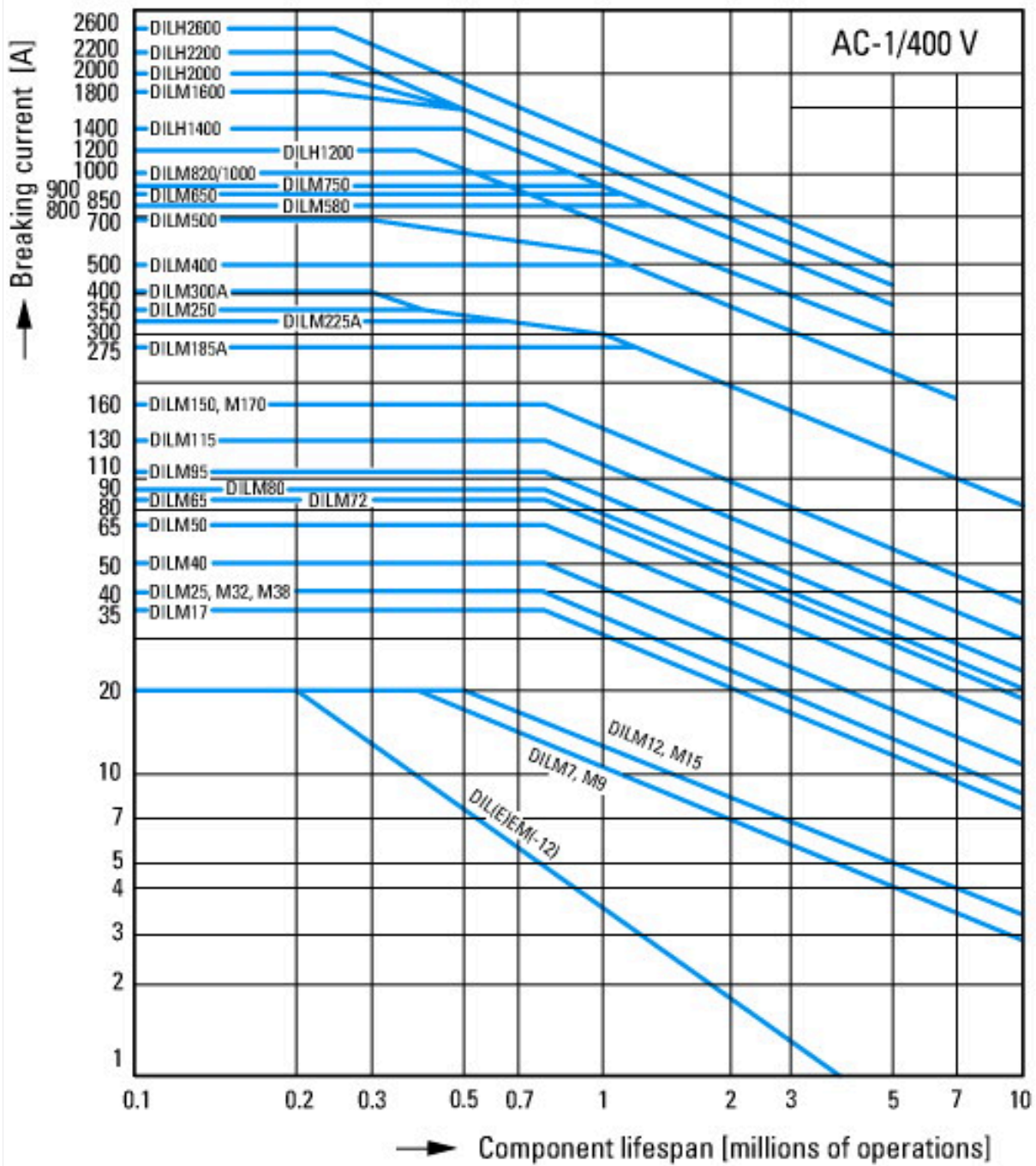

Switching duty for non-motor loads, 3-pole, 4-pole
 Operating characteristics
 Non-inductive or slightly inductive loads
 Electrical characteristics
 Make: 1 x rated current
 Break: 1 x rated current
 Utilization category
 100 % AC-1
 Typical applications
 Electric heat

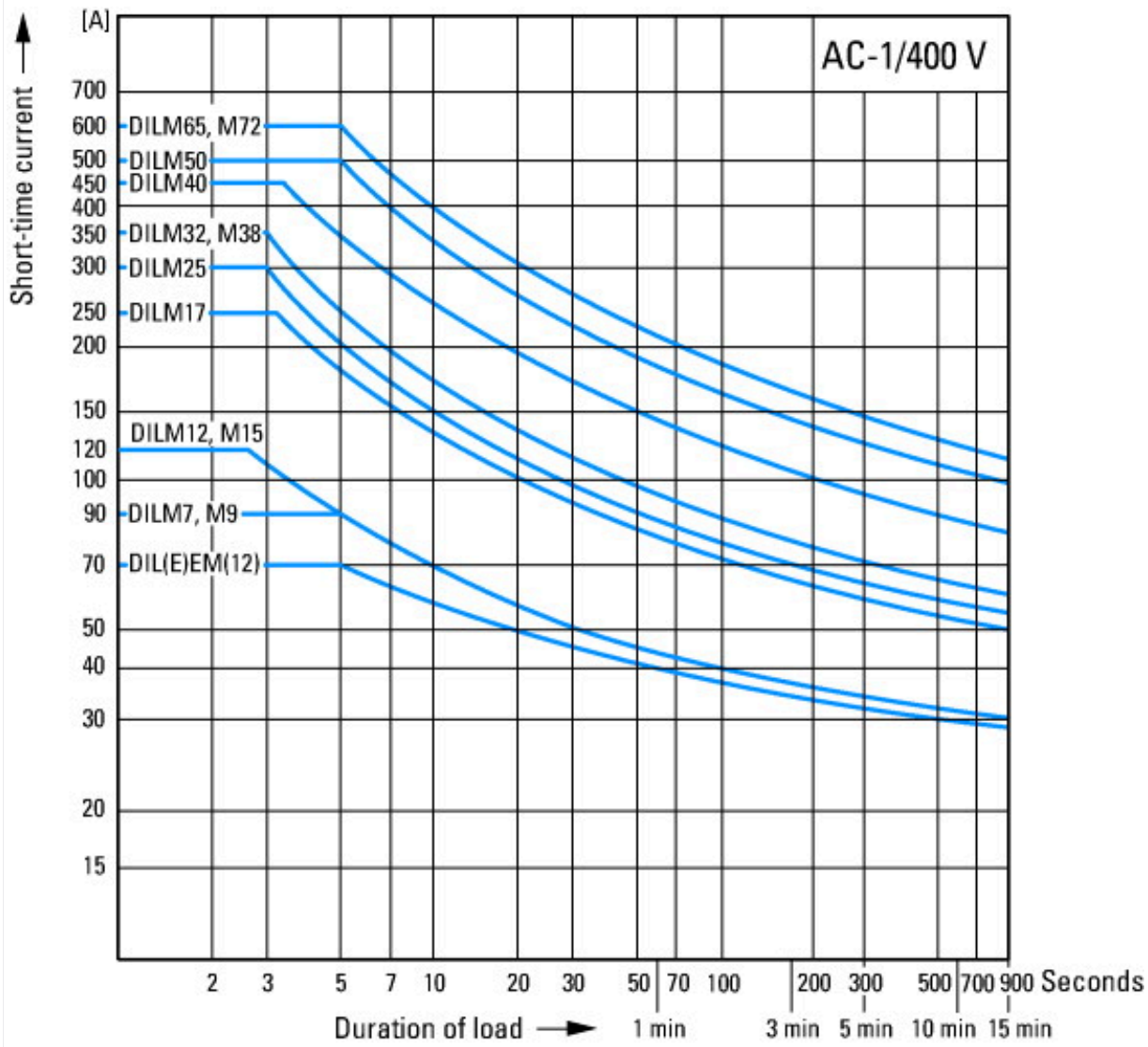

Short-time loading, 3-pole
 Time interval between two loading cycles: 15 minutes

Dimensions

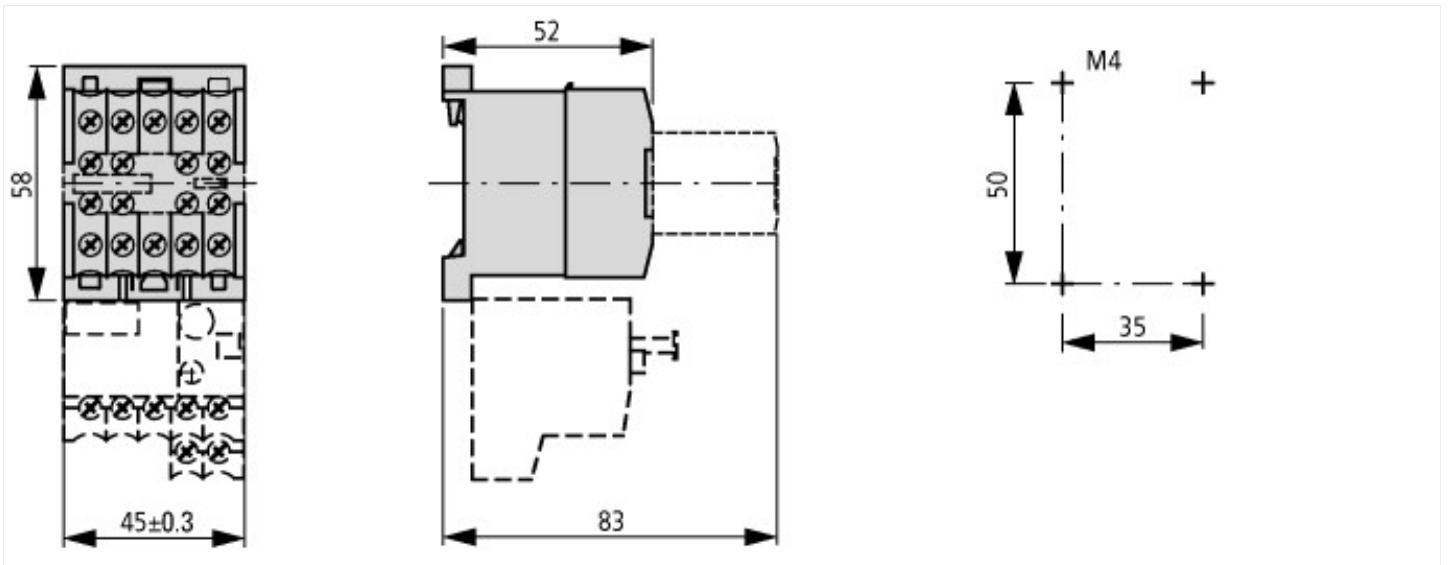

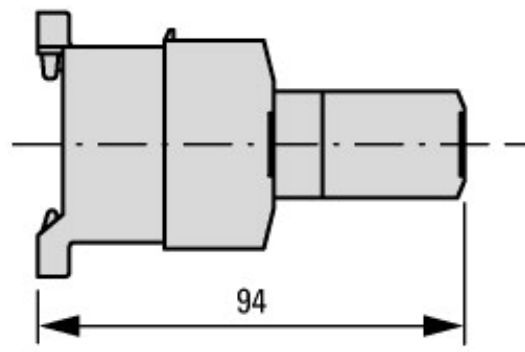
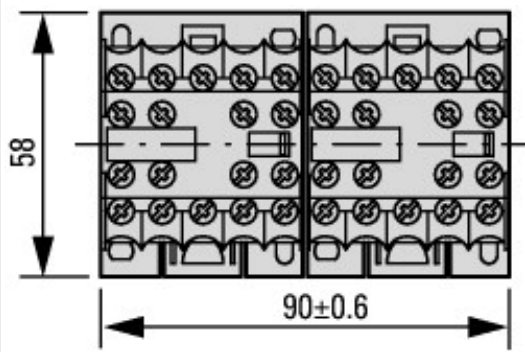

2DILE-... + MVDILE + ...DILE
2DILE-...-G + MVDILE + ...DILE

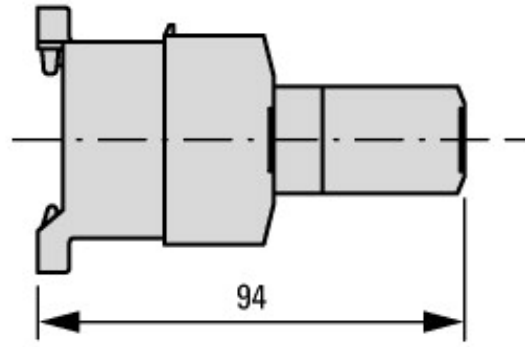
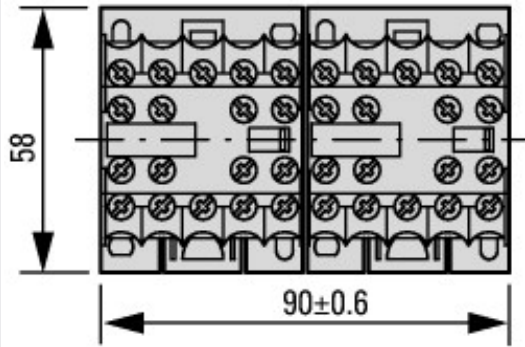

2DILE-... + MVDILE + ...DILE
2DILE-...-G + MVDILE + ...DILE

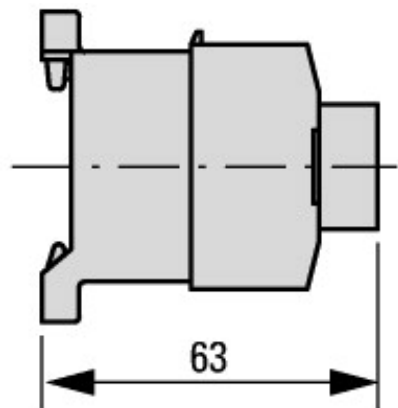
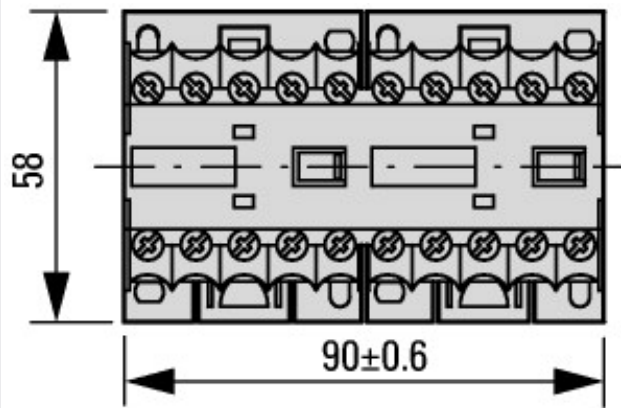

2DILE-... + MVDILE
2DILE-...-G + MVDILE

Additional product information (links)

IL03407009Z (AWA2100-0882) Mini contactor relay

IL03407009Z (AWA2100-0882) Mini contactor relay

https://es-assets.eaton.com/DOCUMENTATION/AWA_INSTRUCTIONS/IL03407009Z2020_05.pdf