

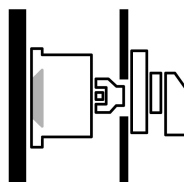

Non-standard switch, T5B, 63 A, rear mounting, 3 contact unit(s)

Part no. **T5B-3-SOND\*/Z**  
 Catalog No. **907970**

### Delivery program

Product range			Non-standard switch
Part group reference			T5B
<b>Notes</b>			customized version according to form
Degree of Protection			Front IP65
Design			rear mounting
			
<b>Motor rating AC-23A, 50 - 60 Hz</b>			
400 V	P	kW	30
Rated uninterrupted current	$I_u$	A	63
Note on rated uninterrupted current $I_u$			Rated uninterrupted current $I_u$ is specified for max. cross-section.
Number of contact units		contact unit(s)	3

### Technical data

#### General

Standards			IEC/EN 60947, VDE 0660, IEC/EN 60204 Switch-disconnector according to IEC/EN 60947-3
Climatic proofing			Damp heat, constant, to IEC 60068-2-78 Damp heat, cyclic, to IEC 60068-2-30
Ambient temperature			
Open		°C	-25 - +50
Enclosed		°C	-25 - +40
Overvoltage category/pollution degree			III/3
Rated impulse withstand voltage	$U_{imp}$	V AC	6000
Mechanical shock resistance		g	15
Mounting position			As required

#### Contacts

Electrical characteristics			
Rated operational voltage	$U_e$	V AC	690
Rated uninterrupted current	$I_u$	A	63
Note on rated uninterrupted current $I_u$			Rated uninterrupted current $I_u$ is specified for max. cross-section.
Load rating with intermittent operation, class 12			
AB 25 % DF		x $I_e$	2
AB 40 % DF		x $I_e$	1.6
AB 60 % DF		x $I_e$	1.3
Short-circuit rating			
Fuse		A gG/gL	80
Rated short-time withstand current (1 s current)	$I_{cw}$	$A_{rms}$	1300
Note on rated short-time withstand current $I_{cw}$			Current for a time of 1 second
Rated conditional short-circuit current	$I_q$	kA	2

#### Switching capacity

cos $\phi$ rated making capacity as per IEC 60947-3		A	800
Rated breaking capacity cos $\phi$ to IEC 60947-3		A	

230 V		A	520
400/415 V		A	600
500 V		A	480
690 V		A	340
Safe isolation to EN 61140			
between the contacts		V AC	440
Current heat loss per contact at $I_e$		W	4.5
Current heat loss per auxiliary circuit at $I_e$ (AC-15/230 V)		CO	4.5
Lifespan, mechanical	Operations	$\times 10^6$	> 0.5
Maximum operating frequency	Operations/h		1200
AC			
AC-3			
Rating, motor load switch	P	kW	
220 V 230 V	P	kW	15
230 V Star-delta	P	kW	18.5
400 V 415 V	P	kW	22
400 V Star-delta	P	kW	30
500 V	P	kW	22
500 V Star-delta	P	kW	37
690 V	P	kW	15
690 V Star-delta	P	kW	22
Rated operational current motor load switch			
230 V	$I_e$	A	51
230 V star-delta	$I_e$	A	63
400V 415 V	$I_e$	A	41
400 V star-delta	$I_e$	A	63
500 V	$I_e$	A	33
500 V star-delta	$I_e$	A	57.2
690 V	$I_e$	A	17
690 V star-delta	$I_e$	A	29.4
AC-21A			
Rated operational current switch			
440 V	$I_e$	A	63
AC-23A			
Motor rating AC-23A, 50 - 60 Hz	P	kW	
230 V	P	kW	18.5
400 V 415 V	P	kW	30
500 V	P	kW	22
690 V	P	kW	22
Rated operational current motor load switch			
230 V	$I_e$	A	63
400 V 415 V	$I_e$	A	63
500 V	$I_e$	A	33
690 V	$I_e$	A	23.8
DC			
DC-1, Load-break switches L/R = 1 ms			
Rated operational current	$I_e$	A	63
Voltage per contact pair in series		V	60
DC-23A, motor load switch L/R = 15 ms			
24 V			
Rated operational current	$I_e$	A	50
Contacts		Quantity	1
48 V			
Rated operational current	$I_e$	A	50

Contacts		Quantity	2
60 V			
Rated operational current	I <sub>e</sub>	A	50
Contacts		Quantity	3
120 V			
Rated operational current	I <sub>e</sub>	A	25
Contacts		Quantity	3
240 V			
Rated operational current	I <sub>e</sub>	A	20
Contacts		Quantity	6
DC-13, Control switches L/R = 50 ms			
Rated operational current	I <sub>e</sub>	A	25
Voltage per contact pair in series		V	24
Control circuit reliability at 24 V DC, 10 mA	Fault probability	H <sub>F</sub>	< 10 <sup>-5</sup> , < 1 failure in 100,000 switching operations

### Terminal capacities

Solid or stranded		mm <sup>2</sup>	1 x (2,5 - 35) 2 x (2,5 - 16)
Flexible with ferrules to DIN 46228		mm <sup>2</sup>	1 x (1 - 25) 2 x (1.5 - 10)
Terminal screw			M6
Tightening torque for terminal screw		Nm	4

### Technical safety parameters:

<b>Notes</b>			B10 <sub>q</sub> values as per EN ISO 13849-1, table C1
--------------	--	--	---

### Rating data for approved types

Terminal capacity			
Terminal screw			M6

## Design verification as per IEC/EN 61439

Technical data for design verification			
Rated operational current for specified heat dissipation	I <sub>n</sub>	A	63
Heat dissipation per pole, current-dependent	P <sub>vid</sub>	W	4.5
Equipment heat dissipation, current-dependent	P <sub>vid</sub>	W	0
Static heat dissipation, non-current-dependent	P <sub>vs</sub>	W	0
Heat dissipation capacity	P <sub>diss</sub>	W	0
Operating ambient temperature min.		°C	-25
Operating ambient temperature max.		°C	50
IEC/EN 61439 design verification			
10.2 Strength of materials and parts			
10.2.2 Corrosion resistance			Meets the product standard's requirements.
10.2.3.1 Verification of thermal stability of enclosures			Meets the product standard's requirements.
10.2.3.2 Verification of resistance of insulating materials to normal heat			Meets the product standard's requirements.
10.2.3.3 Verification of resistance of insulating materials to abnormal heat and fire due to internal electric effects			Meets the product standard's requirements.
10.2.4 Resistance to ultra-violet (UV) radiation			UV resistance only in connection with protective shield.
10.2.5 Lifting			Does not apply, since the entire switchgear needs to be evaluated.
10.2.6 Mechanical impact			Does not apply, since the entire switchgear needs to be evaluated.
10.2.7 Inscriptions			Meets the product standard's requirements.
10.3 Degree of protection of ASSEMBLIES			Does not apply, since the entire switchgear needs to be evaluated.
10.4 Clearances and creepage distances			Meets the product standard's requirements.
10.5 Protection against electric shock			Does not apply, since the entire switchgear needs to be evaluated.
10.6 Incorporation of switching devices and components			Does not apply, since the entire switchgear needs to be evaluated.
10.7 Internal electrical circuits and connections			Is the panel builder's responsibility.
10.8 Connections for external conductors			Is the panel builder's responsibility.
10.9 Insulation properties			
10.9.2 Power-frequency electric strength			Is the panel builder's responsibility.
10.9.3 Impulse withstand voltage			Is the panel builder's responsibility.

10.9.4 Testing of enclosures made of insulating material		Is the panel builder's responsibility.
10.10 Temperature rise		The panel builder is responsible for the temperature rise calculation. Eaton will provide heat dissipation data for the devices.
10.11 Short-circuit rating		Is the panel builder's responsibility. The specifications for the switchgear must be observed.
10.12 Electromagnetic compatibility		Is the panel builder's responsibility. The specifications for the switchgear must be observed.
10.13 Mechanical function		The device meets the requirements, provided the information in the instruction leaflet (IL) is observed.

## Technical data ETIM 7.0

Low-voltage industrial components (EG000017) / Switch disconnecter (EC000216)

Electric engineering, automation, process control engineering / Low-voltage switch technology / Off-load switch, circuit breaker, control switch / Switch disconnecter (ec@ss10.0.1-27-37-14-03 [AKF060013])

Version as main switch		No
Version as maintenance-/service switch		No
Version as safety switch		No
Version as emergency stop installation		No
Version as reversing switch		No
Number of switches		1
Max. rated operation voltage Ue AC	V	690
Rated operating voltage	V	690 - 690
Rated permanent current Iu	A	63
Rated permanent current at AC-23, 400 V	A	63
Rated permanent current at AC-21, 400 V	A	63
Rated operation power at AC-3, 400 V	kW	22
Rated short-time withstand current Icw	kA	1.3
Rated operation power at AC-23, 400 V	kW	30
Switching power at 400 V	kW	30
Conditioned rated short-circuit current Iq	kA	2
Number of poles		0
Number of auxiliary contacts as normally closed contact		0
Number of auxiliary contacts as normally open contact		0
Number of auxiliary contacts as change-over contact		0
Motor drive optional		No
Motor drive integrated		No
Voltage release optional		No
Device construction		Built-in device fixed built-in technique
Suitable for ground mounting		Yes
Suitable for front mounting 4-hole		No
Suitable for front mounting centre		No
Suitable for distribution board installation		No
Suitable for intermediate mounting		Yes
Colour control element		Black
Type of control element		Toggle
Interlockable		No
Type of electrical connection of main circuit		Screw connection
Degree of protection (IP), front side		IP65
Degree of protection (NEMA)		Other

## Dimensions

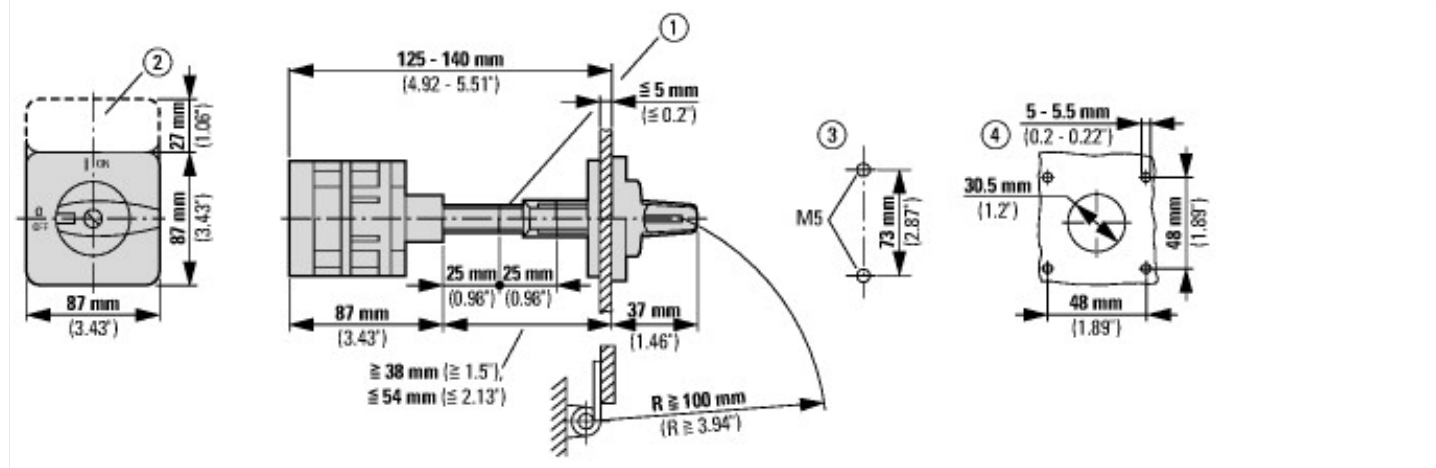

- ① Shaft extension with ZAV-P3 possible, max. 4 x 25 = 100 mm
  - ② ZFS-... Label mount not included as standard
  - ③ Drilling dimensions base
  - ④ Drilling dimensions door
- Cam switches T5B and T5 are of identical design, only their contacts are different

## Assets (links)

### Instruction Leaflets

IL03801009Z2018\_05

## Additional product information (links)

### IL03801009Z (AWA1150-1692) Cam switch: switch-disconnector

IL03801009Z (AWA1150-1692) Cam switch: switch-disconnector	<a href="ftp://ftp.moeller.net/DOCUMENTATION/AWA_INSTRUCTIONS/IL03801009Z2018_05.pdf">ftp://ftp.moeller.net/DOCUMENTATION/AWA_INSTRUCTIONS/IL03801009Z2018_05.pdf</a>
Technical overview cam switch, switch-disconnector	<a href="http://de.ecat.moeller.net/flip-cat/?edition=HPLTEv1&amp;startpage=4.2">http://de.ecat.moeller.net/flip-cat/?edition=HPLTEv1&amp;startpage=4.2</a>
System overview cam switch T	<a href="http://de.ecat.moeller.net/flip-cat/?edition=HPLTEv1&amp;startpage=4.4">http://de.ecat.moeller.net/flip-cat/?edition=HPLTEv1&amp;startpage=4.4</a>
System overview switch-disconnector P	<a href="http://de.ecat.moeller.net/flip-cat/?edition=HPLTEv1&amp;startpage=4.6">http://de.ecat.moeller.net/flip-cat/?edition=HPLTEv1&amp;startpage=4.6</a>
Key to part numbers Cam switch	<a href="http://de.ecat.moeller.net/flip-cat/?edition=HPLTEv1&amp;startpage=4.8">http://de.ecat.moeller.net/flip-cat/?edition=HPLTEv1&amp;startpage=4.8</a>
Key to part numbers Switch-disconnector	<a href="http://de.ecat.moeller.net/flip-cat/?edition=HPLTEv1&amp;startpage=4.8">http://de.ecat.moeller.net/flip-cat/?edition=HPLTEv1&amp;startpage=4.8</a>
Switches for ATEX	<a href="http://www.coopercrouse-hinds.eu/en/products/25-ex-safety-and-main-current-switches.html">http://www.coopercrouse-hinds.eu/en/products/25-ex-safety-and-main-current-switches.html</a>
Ordering form for SOND switches and SOND front plates(DE_EN)	<a href="ftp://ftp.moeller.net/DOCUMENTATION/PDF/MZ008005ZU_Orderform_Customized_Switch.pdf">ftp://ftp.moeller.net/DOCUMENTATION/PDF/MZ008005ZU_Orderform_Customized_Switch.pdf</a>
Ordering form for SOND switches and SOND front plates(DE_EN)	<a href="ftp://ftp.moeller.net/DOCUMENTATION/PDF/MZ008006ZU_Orderform_Customized_Switch.pdf">ftp://ftp.moeller.net/DOCUMENTATION/PDF/MZ008006ZU_Orderform_Customized_Switch.pdf</a>