

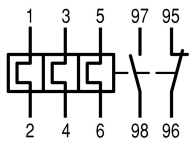



Overload relay, I_r= 50 - 70 A, 1 N/O, 1 N/C, For use with: DILM250

Part no. Z5-70/FF250
Catalog No. 210070
Alternate Catalog No. XTOB070LC1
EL-Nummer (Norway) 4134167

Delivery program

Product range			Overload relay Z5
Phase-failure sensitivity			IEC/EN 60947, VDE 0660 Part 102
Description			Test/off button Reset pushbutton manual/auto Trip-free release
Mounting type			Direct mounting Separate mounting
Setting range			
Overload releases	I _r	A	50 - 70
			
Contact sequence			
Auxiliary contacts			
N/O = Normally open			1 N/O
N/C = Normally closed			1 N/C
For use with			DILM250
Short-circuit protection			
Type "1" coordination	gG/gL	A	250
			
Type "2" coordination	gG/gL	A	160
			

Notes

Overload release: tripping class 10 A
 Short-circuit protection: Observe the maximum permissible fuse of the contactor with direct device mounting.

Notes

Fitted directly to the contactor

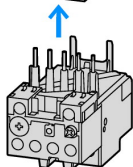
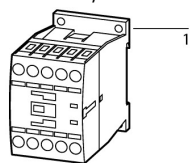

1 Contactor

Technical data

General		
Standards		IEC/EN 60947, VDE 0660, UL, CSA
Climatic proofing		Damp heat, constant, to IEC 60068-2-78 Damp heat, cyclic, to IEC 60068-2-30

Ambient temperature			
Open		°C	-25 - +60
Enclosed		°C	- 25 - 40
Temperature compensation			Continuous
Weight		kg	1.55
Mechanical shock resistance		g	10 Sinusoidal Shock duration 10 ms
Degree of Protection			IP00
Protection against direct contact when actuated from front (EN 50274)			With terminal cover
Altitude		m	Max. 2000

Main conducting paths

Rated impulse withstand voltage	U_{imp}	V AC	8000
Overvoltage category/pollution degree			III/3
Rated insulation voltage	U_i	V	1000
Rated operational voltage	U_e	V AC	1000
Safe isolation to EN 61140			
Between auxiliary contacts and main contacts		V AC	500
Between main circuits		V AC	500
Temperature compensation residual error > 40°C			$\leq 0.25 \%/K$
Current heat loss (3 conductors)			
Lower value of the setting range		W	10
Maximum setting		W	20
Terminal capacities		mm ²	
Flexible with cable lug		mm ²	185
Stranded with cable lug		mm ²	185
Solid or stranded		AWG	2/0 - 500 MCM
Busbar	Width	mm	25
Terminal screw			M10 x 35
Tightening torque		Nm	18
Tools			
Hexagon head spanner	SW	mm	16

Auxiliary and control circuits

Rated impulse withstand voltage	U_{imp}	V	4000
Overvoltage category/pollution degree			III/3
Terminal capacities		mm ²	
Solid		mm ²	1 x (0.75 - 4) 2 x (0.75 - 4)
Flexible with ferrule		mm ²	1 x (0.75 - 2.5) 2 x (0.75 - 2.5)
Solid or stranded		AWG	2 x (18 - 14)
Terminal screw			M3.5
Tightening torque		Nm	1.2
Stripping length		mm	8
Tools			
Pozidriv screwdriver		Size	2
Standard screwdriver		mm	1 x 6
Rated insulation voltage	U_i	V AC	500
Rated operational voltage	U_e	V AC	500
Safe isolation to EN 61140			
between the auxiliary contacts		V AC	240
Conventional thermal current	I_{th}	A	6
Rated operational current	I_e	A	
AC-15			
Make contact			
120 V	I_e	A	1.5

220 V 230 V 240 V	I_e	A	1.5
380 V 400 V 415 V	I_e	A	0.5
500 V	I_e	A	0.5
Break contact			
120 V	I_e	A	1.5
220 V 230 V 240 V	I_e	A	1.5
380 V 400 V 415 V	I_e	A	0.9
500 V	I_e	A	0.8
DC L/R \leq 15 ms			
			Switch-on and switch-off conditions based on DC-13, time constant as specified.
24 V	I_e	A	0.9
60 V	I_e	A	0.75
110 V	I_e	A	0.4
220 V	I_e	A	0.2
Short-circuit rating without welding			
max. fuse		A gG/gL	6

Notes

Notes Ambient air temperature: Operating range to IEC/EN 60947

Rating data for approved types

Auxiliary contacts			
Pilot Duty			
AC operated			B300 at opposite polarity B600 at same polarity
DC operated			R300
Short Circuit Current Rating		SCCR	
Basic Rating			
SCCR		kA	10
max. Fuse		A	250
max. CB		A	250

Design verification as per IEC/EN 61439

Technical data for design verification			
Rated operational current for specified heat dissipation	I_n	A	70
Heat dissipation per pole, current-dependent	P_{vid}	W	7
Equipment heat dissipation, current-dependent	P_{vid}	W	21
Static heat dissipation, non-current-dependent	P_{vs}	W	0
Heat dissipation capacity	P_{diss}	W	0
Operating ambient temperature min.		°C	-25
Operating ambient temperature max.		°C	60
IEC/EN 61439 design verification			
10.2 Strength of materials and parts			
10.2.2 Corrosion resistance			Meets the product standard's requirements.
10.2.3.1 Verification of thermal stability of enclosures			Meets the product standard's requirements.
10.2.3.2 Verification of resistance of insulating materials to normal heat			Meets the product standard's requirements.
10.2.3.3 Verification of resistance of insulating materials to abnormal heat and fire due to internal electric effects			Meets the product standard's requirements.
10.2.4 Resistance to ultra-violet (UV) radiation			Meets the product standard's requirements.
10.2.5 Lifting			Does not apply, since the entire switchgear needs to be evaluated.
10.2.6 Mechanical impact			Does not apply, since the entire switchgear needs to be evaluated.
10.2.7 Inscriptions			Meets the product standard's requirements.
10.3 Degree of protection of ASSEMBLIES			Does not apply, since the entire switchgear needs to be evaluated.
10.4 Clearances and creepage distances			Meets the product standard's requirements.
10.5 Protection against electric shock			Does not apply, since the entire switchgear needs to be evaluated.
10.6 Incorporation of switching devices and components			Does not apply, since the entire switchgear needs to be evaluated.
10.7 Internal electrical circuits and connections			Is the panel builder's responsibility.

10.8 Connections for external conductors			Is the panel builder's responsibility.
10.9 Insulation properties			
10.9.2 Power-frequency electric strength			Is the panel builder's responsibility.
10.9.3 Impulse withstand voltage			Is the panel builder's responsibility.
10.9.4 Testing of enclosures made of insulating material			Is the panel builder's responsibility.
10.10 Temperature rise			The panel builder is responsible for the temperature rise calculation. Eaton will provide heat dissipation data for the devices.
10.11 Short-circuit rating			Is the panel builder's responsibility. The specifications for the switchgear must be observed.
10.12 Electromagnetic compatibility			Is the panel builder's responsibility. The specifications for the switchgear must be observed.
10.13 Mechanical function			The device meets the requirements, provided the information in the instruction leaflet (IL) is observed.

Technical data ETIM 7.0

Low-voltage industrial components (EG000017) / Thermal overload relay (EC000106)			
Electric engineering, automation, process control engineering / Low-voltage switch technology / Overload protection device / Thermal overload relay (ecl@ss10.0.1-27-37-15-01 [AKF075014])			
Adjustable current range		A	50 - 70
Max. rated operation voltage U _e		V	1000
Mounting method			Direct attachment
Type of electrical connection of main circuit			Screw connection
Number of auxiliary contacts as normally closed contact			1
Number of auxiliary contacts as normally open contact			1
Number of auxiliary contacts as change-over contact			0
Release class			CLASS 10
Reset function input			No
Reset function automatic			Yes
Reset function push-button			Yes

Approvals

Product Standards			IEC/EN 60947-4-1; UL 60947-4-1; CSA - C22.2 No. 60947-4-1-14; CE marking
UL File No.			E29184
UL Category Control No.			NKCR
CSA File No.			12528
CSA Class No.			3211-03
North America Certification			UL listed, CSA certified
Specially designed for North America			No
Suitable for			Branch circuits
Max. Voltage Rating			600 V AC
Degree of Protection			IEC: IP00, UL/CSA Type: -

Characteristics

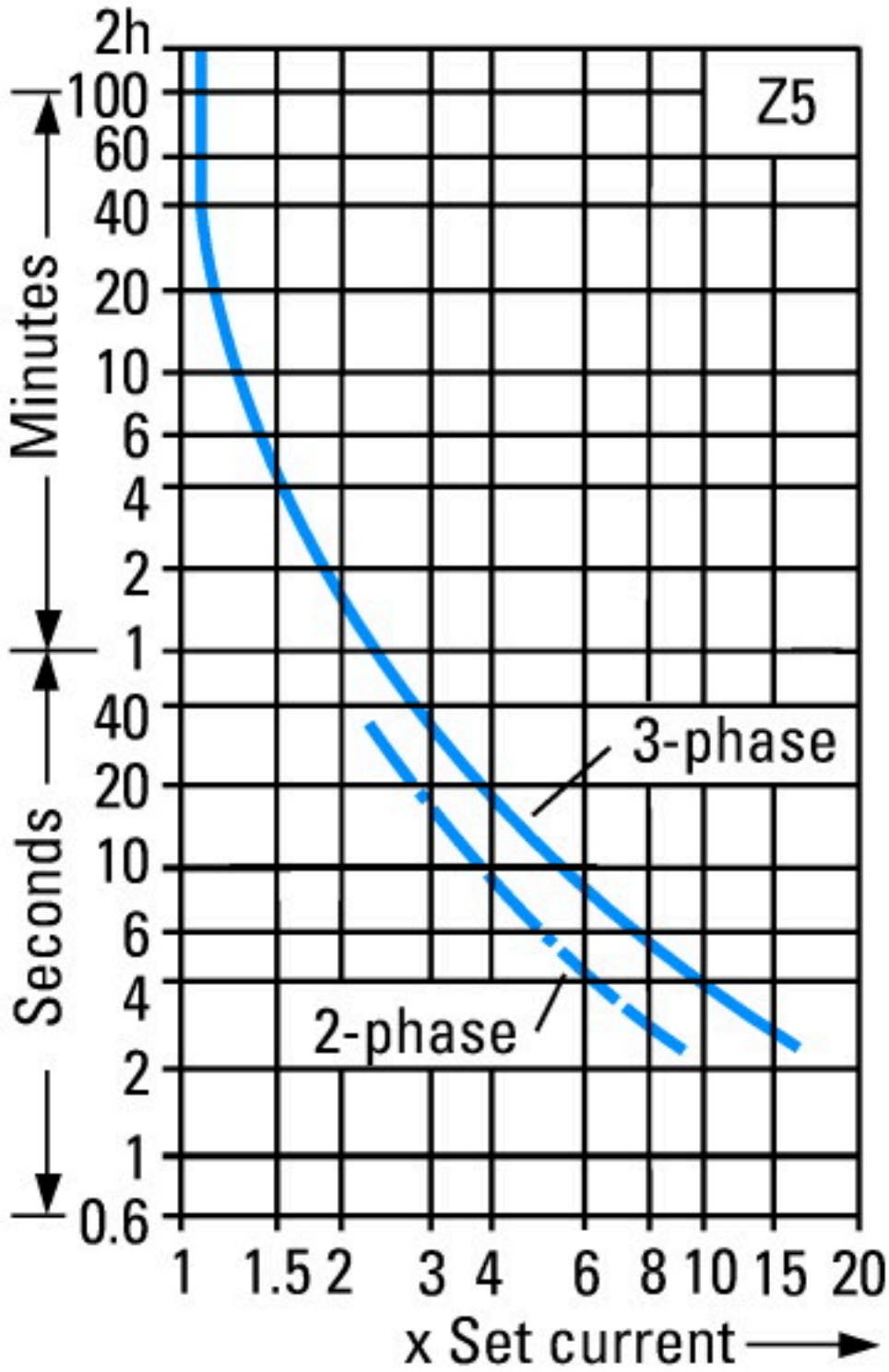

These tripping characteristics are mean values of the spreads at 20 °C ambient air temperature in a cold state.
Tripping time depends on response current.
When the devices are at operational temperature the tripping time of the overload relay falls to approx. 25 % of the read off value.

Tolerances for tripping times: max. $\pm 20\%$
Toleranzen für Auslösezeiten: max. $\pm 20\%$
Tolérances temps de déclenchement: $\pm 20\%$

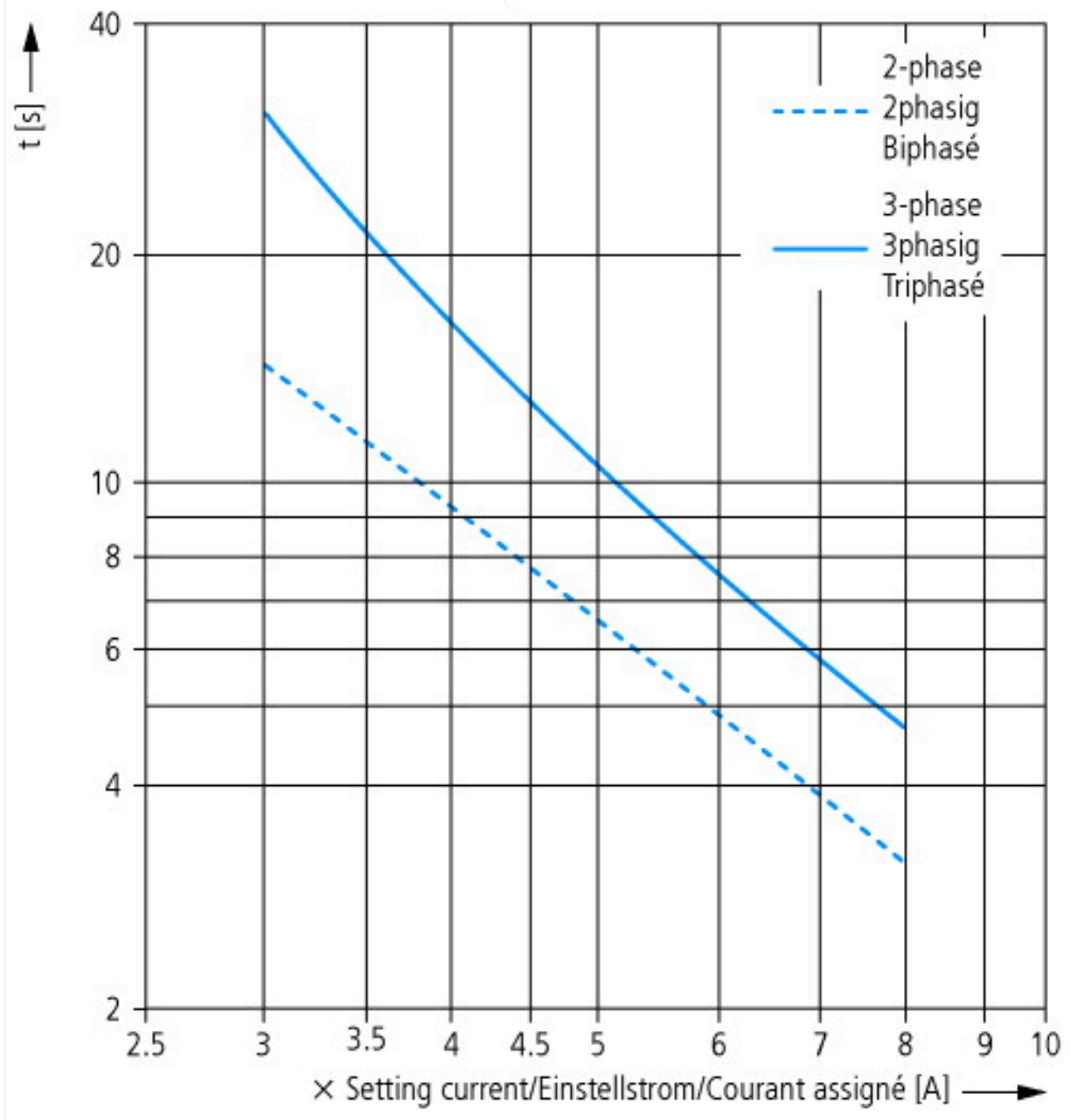

Dimensions

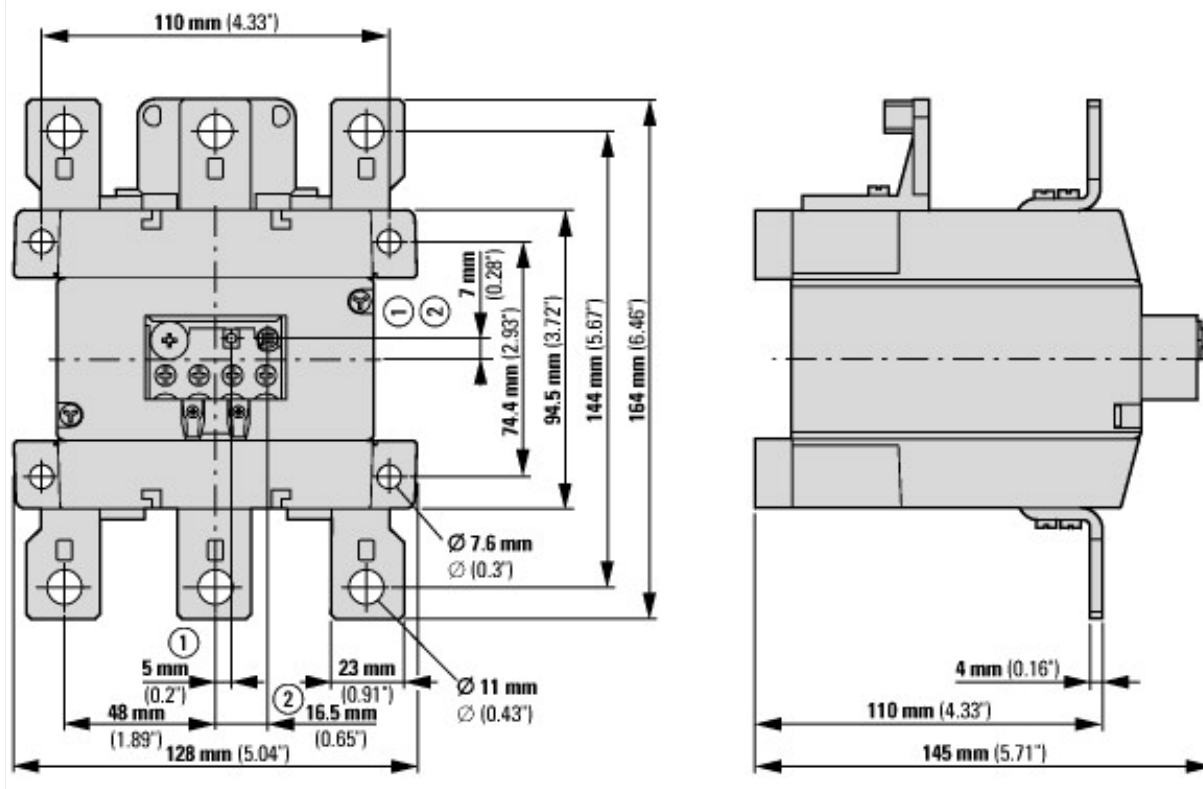

- ① OFF
- ② Reset/ON

Assets (links)

Declaration of CE Conformity

00002879

Instruction Leaflets

IL03407006Z2018_03

Manuals

h1476dgb (English)

Additional product information (links)

IL03407006Z (AWA2300-1276) Overload relay

IL03407006Z (AWA2300-1276) Overload relay ftp://ftp.moeller.net/DOCUMENTATION/AWA_INSTRUCTIONS/IL03407006Z2018_03.pdf

IL03407081Z (AWA2300-1901) NA terminal

IL03407081Z (AWA2300-1901) NA terminal ftp://ftp.moeller.net/DOCUMENTATION/AWA_INSTRUCTIONS/IL03407081Z2018_05.pdf