



Control transformer, 0.4 kVA, Rated input voltage 100 – 690 ± 5 % V, Rated output voltage 12 – 250 V

Part no. STN0,4(*/*)
Catalog No. 204983
Alternate Catalog No. -

Delivery program

Product range		Single-phase control transformers ST...
Basic function		Single-phase STN control transformers
Rated input voltage	V	100 – 690 ± 5 %
Rated output voltage	V	12 – 250
Rated power	kVA	0.4
Short-time rating	kVA	0.62
Cu factor 1,10		
Notes		
		<ul style="list-style-type: none"> The STN transformers are suitable for use in control circuits to VDE 0113 or IEC/EN 60204. UL/CSA only up to primary and secondary 600 V (incl. tappings). When ordering, the type reference must include the following details:
STN0,1(*/*)		
1st wildcard \triangleq Nominal input voltage		
2nd wildcard \triangleq Rated output voltage		
Ordering example		
		<ul style="list-style-type: none"> Desired part no.: STN0,1 Desired rated input voltage 200 V Desired rated output voltage 18.5 V
The correct type reference is		
STN0,1(200/18,5)		
Transformer-protective circuit-breaker \rightarrow #088907		

Technical data

General

Standards		
Built and tested to		IEC/EN 61558-2-2 VDE 0570 Part 2-2
Suitable for use to		IEC/EN 60204-1, ÖVE-EN 13 VDE 0113, VDE 0100 Part 410
Ambient temperature		-25 - 40

Characteristics

Terminations		● (< 115 A)
Connection lugs		● (> 115 A)
Insulation class		B
Rated frequency	Hz	50 - 60
Primary tapping		± 5 %
Degree of Protection		IP00
Separate windings		●
Fully vacuum-impregnated		●
Rated duty factor	% DF	100

Electrical characteristics

Note		The following applies for the no-load loss, short-circuit loss (copper losses), short-circuit voltage and efficiency values: all details relate to a temperature of 20 °C
Total weight	kg	4.2
No-load losses	W	12
Short-circuit losses	W	27

Shortcircuit voltage		%	5.3
Efficiency			0.92

Design verification as per IEC/EN 61439

Technical data for design verification			
Rated operational current for specified heat dissipation	I_n	A	0
Heat dissipation per pole, current-dependent	P_{vid}	W	0
Equipment heat dissipation, current-dependent	P_{vid}	W	0
Static heat dissipation, non-current-dependent	P_{vs}	W	39
Heat dissipation capacity	P_{diss}	W	0
Operating ambient temperature min.		°C	-25
Operating ambient temperature max.		°C	40
IEC/EN 61439 design verification			
10.2 Strength of materials and parts			
10.2.2 Corrosion resistance			Meets the product standard's requirements.
10.2.3.1 Verification of thermal stability of enclosures			Meets the product standard's requirements.
10.2.3.2 Verification of resistance of insulating materials to normal heat			Meets the product standard's requirements.
10.2.3.3 Verification of resistance of insulating materials to abnormal heat and fire due to internal electric effects			Meets the product standard's requirements.
10.2.4 Resistance to ultra-violet (UV) radiation			Meets the product standard's requirements.
10.2.5 Lifting			Does not apply, since the entire switchgear needs to be evaluated.
10.2.6 Mechanical impact			Does not apply, since the entire switchgear needs to be evaluated.
10.2.7 Inscriptions			Meets the product standard's requirements.
10.3 Degree of protection of ASSEMBLIES			Does not apply, since the entire switchgear needs to be evaluated.
10.4 Clearances and creepage distances			Meets the product standard's requirements.
10.5 Protection against electric shock			Does not apply, since the entire switchgear needs to be evaluated.
10.6 Incorporation of switching devices and components			Does not apply, since the entire switchgear needs to be evaluated.
10.7 Internal electrical circuits and connections			Is the panel builder's responsibility.
10.8 Connections for external conductors			Is the panel builder's responsibility.
10.9 Insulation properties			
10.9.2 Power-frequency electric strength			Is the panel builder's responsibility.
10.9.3 Impulse withstand voltage			Is the panel builder's responsibility.
10.9.4 Testing of enclosures made of insulating material			Is the panel builder's responsibility.
10.10 Temperature rise			The panel builder is responsible for the temperature rise calculation. Eaton will provide heat dissipation data for the devices.
10.11 Short-circuit rating			Is the panel builder's responsibility. The specifications for the switchgear must be observed.
10.12 Electromagnetic compatibility			Is the panel builder's responsibility. The specifications for the switchgear must be observed.
10.13 Mechanical function			The device meets the requirements, provided the information in the instruction leaflet (IL) is observed.

Technical data ETIM 7.0

Low-voltage industrial components (EG000017) / One-phase control transformer (EC002486)		
Electric engineering, automation, process control engineering / Transformer, converter, coil / Control transformer / One-phase control transformer (ecl@ss10.0.1-27-03-13-02 [AAB620015])		
Built as safety transformer		No
Built as isolating transformer		No
Built as energy saving transformer		No
Primary voltage 1	V	100 - 690
Primary voltage 2	V	0 - 0
Primary voltage 3	V	0 - 0
Primary voltage 4	V	0 - 0
Primary voltage 5	V	0 - 0
Primary voltage 6	V	0 - 0
Primary voltage 7	V	0 - 0
Primary voltage 8	V	0 - 0
Primary voltage 9	V	0 - 0

Primary voltage 10	V	0 - 0
Secondary voltage 1	V	12 - 250
Secondary voltage 2	V	0 - 0
Secondary voltage 3	V	0 - 0
Secondary voltage 4	V	0 - 0
Secondary voltage 5	V	0 - 0
Secondary voltage 6	V	0 - 0
Secondary voltage 7	V	0 - 0
Secondary voltage 8	V	0 - 0
Secondary voltage 9	V	0 - 0
Secondary voltage 10	V	0 - 0
Rated apparent power	VA	400
Type of insulation material acc. IEC 85		B
Short-circuit-proof		No
Relative short circuit voltage	%	5.3
Width	mm	121
Height	mm	131
Depth	mm	88
Degree of protection (IP)		IP00
Ring core		No
Suitable for mounting on PCB		No
Modular version		No
Conductor material		Copper

Approvals

Product Standards		UL 506; UL5085-1; UL 5085-2; CSA-C22.2 No. 66; CSA-C22.2 No. 66.1-06; CSA-C22.2 No. 66.2-06; IEC/EN 61558-2-2; CE marking
UL File No.		E167225
UL Category Control No.		XPTQ2, XPTQ8
CSA File No.		UL report applies to both US and Canada
CSA Class No.		-
North America Certification		UL recognized, certified by UL for use in Canada
Specially designed for North America		No
Suitable for		Branch circuits
Max. Voltage Rating		600 V AC
Degree of Protection		IEC: IP00, UL/CSA Type: -

Dimensions

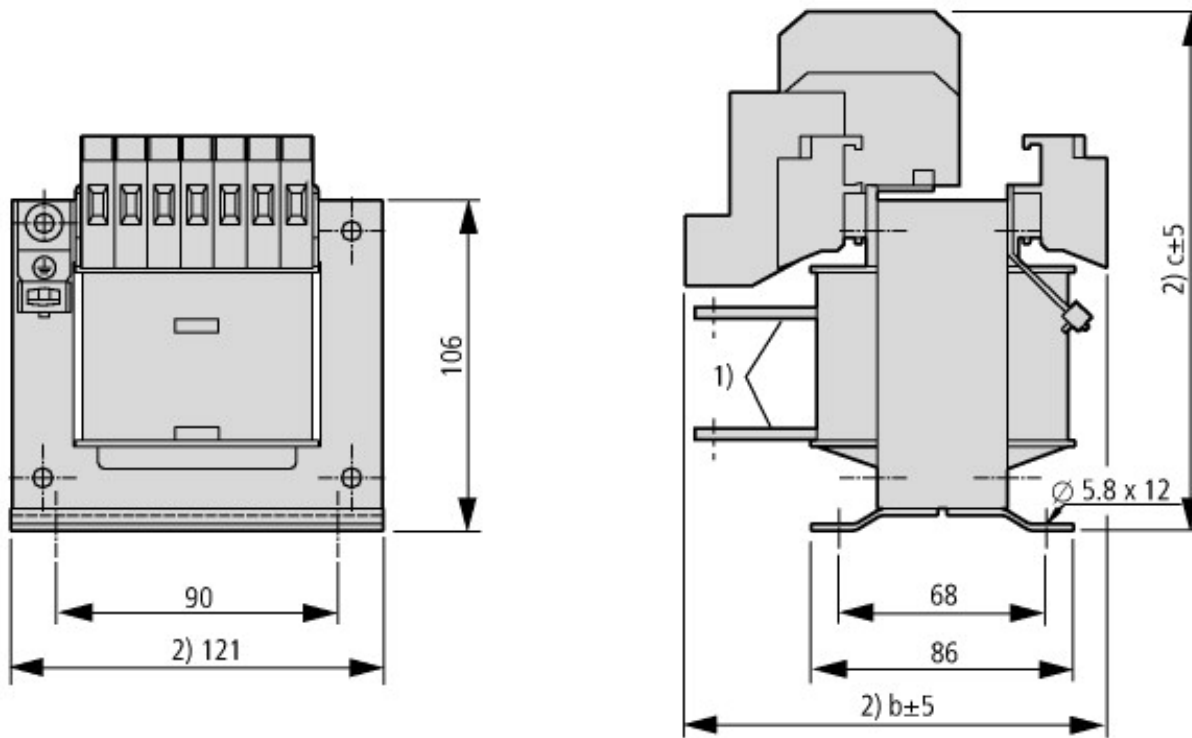

	b	c
12 V	108	133
24 V	88	124
42 V	88	124
110 V	88	124
200/230 V	88	124

- ① Connection lugs
- ② Maximum space requirement
- ③ with STN0,06-02 ground connection at bottom