



Variable frequency drive, 600 V AC, 3-phase, 630 kW, IP00, OLED display, FR12



**Part no.** SPX600A0-5A2N1  
**Catalog No.** 129614  
**Alternate Catalog No.** SPX600A0-5A2N1

### Delivery program

Product range			Variable frequency drives
Part group reference (e.g. DIL)			SPX
Rated operational voltage	U <sub>e</sub>		600 V AC, 3-phase 690 V AC, 3-phase
Output voltage with V <sub>e</sub>	U <sub>2</sub>		600 V AC, 3-phase 690 V AC, 3-phase
Mains voltage (50/60Hz)	U <sub>LN</sub>	V	525 (-15%) - 690 (±10%)
<b>Rated operational current</b>			
At 150% overload	I <sub>e</sub>	A	650
At 110% overload	I <sub>e</sub>	A	750
<b>Assigned motor rating</b>			
Note			For AC motors with internal and external ventilation with 50 Hz / 60 Hz
Note			Overload cycle for 60 s every 600 s
Note			at 690 V, 50 Hz
150 % Overload	P	kW	630
110 % Overload	P	kW	710
Note			at 690 V, 60 Hz
150 % Overload	P	HP	600
110 % Overload	P	HP	850
150 % Overload	I <sub>M</sub>	A	478
110 % Overload	I <sub>M</sub>	A	721
Degree of Protection			IP00
Fieldbus connection (optional)			PROFIBUS-DP PROFINET EtherCAT EtherNet/IP LonWorks CANopen® DeviceNet Modbus-TCP Modbus-RTU BACnet MS/TP
Fitted with			OLED display
Frame size			FR12
Connection to SmartWire-DT			no

### Technical data

#### General

Standards			Specification for general requirements: IEC/EN 61800-2 EMC requirements: IEC/EN 61800-3 Safety requirements: IEC/EN 61800-5-1
Certifications			CE, UL, cUL, RCM
Approvals			DNV
Production quality			RoHS, ISO 9001
Climatic proofing	ρ <sub>w</sub>	%	< 95% relative humidity, no condensation, no corrosion, no dripping water
Ambient temperature			
Operating ambient temperature min.		°C	-10
Operating ambient temperature max.		°C	+40
Storage	θ	°C	-40 - +70
Radio interference level			

Radio interference class (EMC)			C2, C3, depending on the motor cable length, the connected load, and ambient conditions. External radio interference suppression filters (optional) may be necessary.
Environment (EMC)			1st and 2nd environments as per EN 61800-3
Mounting position			Vertical
Altitude		m	0 - 1000 m above sea level above 1000 m with 1 % performance reduction per 100 m max. 3000 m
Degree of Protection			IP00
Protection against direct contact			BGV A3 (VBG4, finger- and back-of-hand proof)

### Main circuit

Supply			
Rated operational voltage	$U_e$		600 V AC, 3-phase 690 V AC, 3-phase
Mains voltage (50/60Hz)	$U_{LN}$	V	525 (-15%) - 690 ( $\pm 10\%$ )
System configuration			AC supply systems with earthed center point
Supply frequency	$f_{LN}$	Hz	50/60
Frequency range	$f_{LN}$	Hz	45–66 ( $\pm 0\%$ )
Power section			
Function			Variable frequency drive with internal DC link and IGBT inverter
Output voltage with $V_e$	$U_2$		600 V AC, 3-phase 690 V AC, 3-phase
Output Frequency	$f_2$	Hz	0 - 50/60 (max. 320)
Switching frequency	$f_{PWM}$	kHz	1.5 adjustable 1 - 6
Operation Mode			U/f control sensorless vector control (SLV) optional: Vector control with feedback (CLV)
Frequency resolution (setpoint value)	$\Delta f$	Hz	0.01
Rated operational current			
At 150% overload	$I_e$	A	650
At 110% overload	$I_e$	A	750
Fitted with			OLED display
Frame size			FR12
Motor feeder			
Note			For AC motors with internal and external ventilation with 50 Hz / 60 Hz
Note			Overload cycle for 60 s every 600 s
Note			at 690 V, 50 Hz
150 % Overload	P	kW	630
110 % Overload	P	kW	710
Note			at 690 V, 60 Hz
150 % Overload	P	HP	600
110 % Overload	P	HP	850

### Control section

External control voltage	$U_c$	V	24 V DC (max. 250 mA)
Reference voltage	$U_s$	V	10 V DC (max. 10 mA)
Analog inputs			2, parameterizable, 0 - 10 V DC, 0/4 - 20 mA
Analog outputs			1, parameterizable, 0/4 - 20 mA
Digital inputs			6, parameterizable, max. 30 V DC
Digital outputs			1, parameterizable, 48 V DC/50 mA
Relay outputs			2, parameterizable, N/O, 8 A (24 V DC) / 8 A (250 V AC) / 0,4 A (125 V DC)

### Assigned switching and protective elements

Motor feeder			
motor choke			
150 % overload (CT/I <sub>H</sub> , at 50 °C)			DUT-0820-6-0-S
110 % overload (VT/I <sub>L</sub> , at 40 °C)			DUT-0820-6-0-S
Sine filter			
150 % overload (CT/I <sub>H</sub> , at 50 °C)			SIN-0780-6-0-P
110 % overload (VT/I <sub>L</sub> , at 40 °C)			SIN-0780-6-0-P

## Design verification as per IEC/EN 61439

Technical data for design verification			
Rated operational current for specified heat dissipation	$I_n$	A	650
Heat dissipation per pole, current-dependent	$P_{vid}$	W	0
Equipment heat dissipation, current-dependent	$P_{vid}$	W	15750
Static heat dissipation, non-current-dependent	$P_{vs}$	W	0
Heat dissipation capacity	$P_{diss}$	W	0
Operating ambient temperature min.		°C	-10
Operating ambient temperature max.		°C	40
			Operation (with 150 % overload)
IEC/EN 61439 design verification			
10.2 Strength of materials and parts			
10.2.2 Corrosion resistance			
			Meets the product standard's requirements.
10.2.3.1 Verification of thermal stability of enclosures			
			Meets the product standard's requirements.
10.2.3.2 Verification of resistance of insulating materials to normal heat			
			Meets the product standard's requirements.
10.2.3.3 Verification of resistance of insulating materials to abnormal heat and fire due to internal electric effects			
			Meets the product standard's requirements.
10.2.4 Resistance to ultra-violet (UV) radiation			
			Meets the product standard's requirements.
10.2.5 Lifting			
			Does not apply, since the entire switchgear needs to be evaluated.
10.2.6 Mechanical impact			
			Does not apply, since the entire switchgear needs to be evaluated.
10.2.7 Inscriptions			
			Meets the product standard's requirements.
10.3 Degree of protection of ASSEMBLIES			
			Does not apply, since the entire switchgear needs to be evaluated.
10.4 Clearances and creepage distances			
			Meets the product standard's requirements.
10.5 Protection against electric shock			
			Does not apply, since the entire switchgear needs to be evaluated.
10.6 Incorporation of switching devices and components			
			Does not apply, since the entire switchgear needs to be evaluated.
10.7 Internal electrical circuits and connections			
			Is the panel builder's responsibility.
10.8 Connections for external conductors			
			Is the panel builder's responsibility.
10.9 Insulation properties			
10.9.2 Power-frequency electric strength			
			Is the panel builder's responsibility.
10.9.3 Impulse withstand voltage			
			Is the panel builder's responsibility.
10.9.4 Testing of enclosures made of insulating material			
			Is the panel builder's responsibility.
10.10 Temperature rise			
			The panel builder is responsible for the temperature rise calculation. Eaton will provide heat dissipation data for the devices.
10.11 Short-circuit rating			
			Is the panel builder's responsibility. The specifications for the switchgear must be observed.
10.12 Electromagnetic compatibility			
			Is the panel builder's responsibility. The specifications for the switchgear must be observed.
10.13 Mechanical function			
			The device meets the requirements, provided the information in the instruction leaflet (IL) is observed.

## Technical data ETIM 7.0

Low-voltage industrial components (EG000017) / Frequency converter =< 1 kV (EC001857)			
Electric engineering, automation, process control engineering / Electrical drive / Static frequency converter / Static frequency converter = < 1 kV (ec@ss10.0.1-27-02-31-01 [AKE177014])			
Mains voltage		V	525 - 690
Mains frequency			50/60 Hz
Number of phases input			3
Number of phases output			3
Max. output frequency		Hz	320
Max. output voltage		V	690
Nominal output current I2N		A	750
Max. output at quadratic load at rated output voltage		kW	710
Max. output at linear load at rated output voltage		kW	630
Relative symmetric net frequency tolerance		%	10
Relative symmetric net voltage tolerance		%	10
Number of analogue outputs			1
Number of analogue inputs			2
Number of digital outputs			1

Number of digital inputs		6
With control unit		Yes
Application in industrial area permitted		Yes
Application in domestic- and commercial area permitted		Yes
Supporting protocol for TCP/IP		Yes
Supporting protocol for PROFIBUS		Yes
Supporting protocol for CAN		Yes
Supporting protocol for INTERBUS		No
Supporting protocol for ASI		No
Supporting protocol for KNX		No
Supporting protocol for MODBUS		No
Supporting protocol for Data-Highway		Yes
Supporting protocol for DeviceNet		Yes
Supporting protocol for SUCONET		No
Supporting protocol for LON		Yes
Supporting protocol for PROFINET IO		No
Supporting protocol for PROFINET CBA		No
Supporting protocol for SERCOS		No
Supporting protocol for Foundation Fieldbus		No
Supporting protocol for EtherNet/IP		No
Supporting protocol for AS-Interface Safety at Work		No
Supporting protocol for DeviceNet Safety		No
Supporting protocol for INTERBUS-Safety		No
Supporting protocol for PROFIsafe		No
Supporting protocol for SafetyBUS p		No
Supporting protocol for BACnet		No
Supporting protocol for other bus systems		Yes
Number of HW-interfaces industrial Ethernet		0
Number of interfaces PROFINET		0
Number of HW-interfaces RS-232		0
Number of HW-interfaces RS-422		0
Number of HW-interfaces RS-485		1
Number of HW-interfaces serial TTY		0
Number of HW-interfaces USB		0
Number of HW-interfaces parallel		0
Number of HW-interfaces other		1
With optical interface		No
With PC connection		Yes
Integrated breaking resistance		No
4-quadrant operation possible		Yes
Type of converter		U converter
Degree of protection (IP)		IP00
Degree of protection (NEMA)		Other
Height	mm	762
Width	mm	1575
Depth	mm	2362

## Approvals

Product Standards		UL 508C; CSA-C22.2 No. 14; IEC/EN61800-3; IEC/EN61800-5; CE marking
UL File No.		E134360
UL Category Control No.		NMMS, NMMS2, NMMS7, NMMS8
CSA File No.		UL report applies to both US and Canada
CSA Class No.		3211-06
North America Certification		UL listed, certified by UL for use in Canada
Specially designed for North America		No

Suitable for	Branch circuits
Max. Voltage Rating	3- 690 V AC IEC: TN-S UL/CSA: "Y" (Solidly Grounded Wey)
Degree of Protection	IEC: IP00

## Dimensions

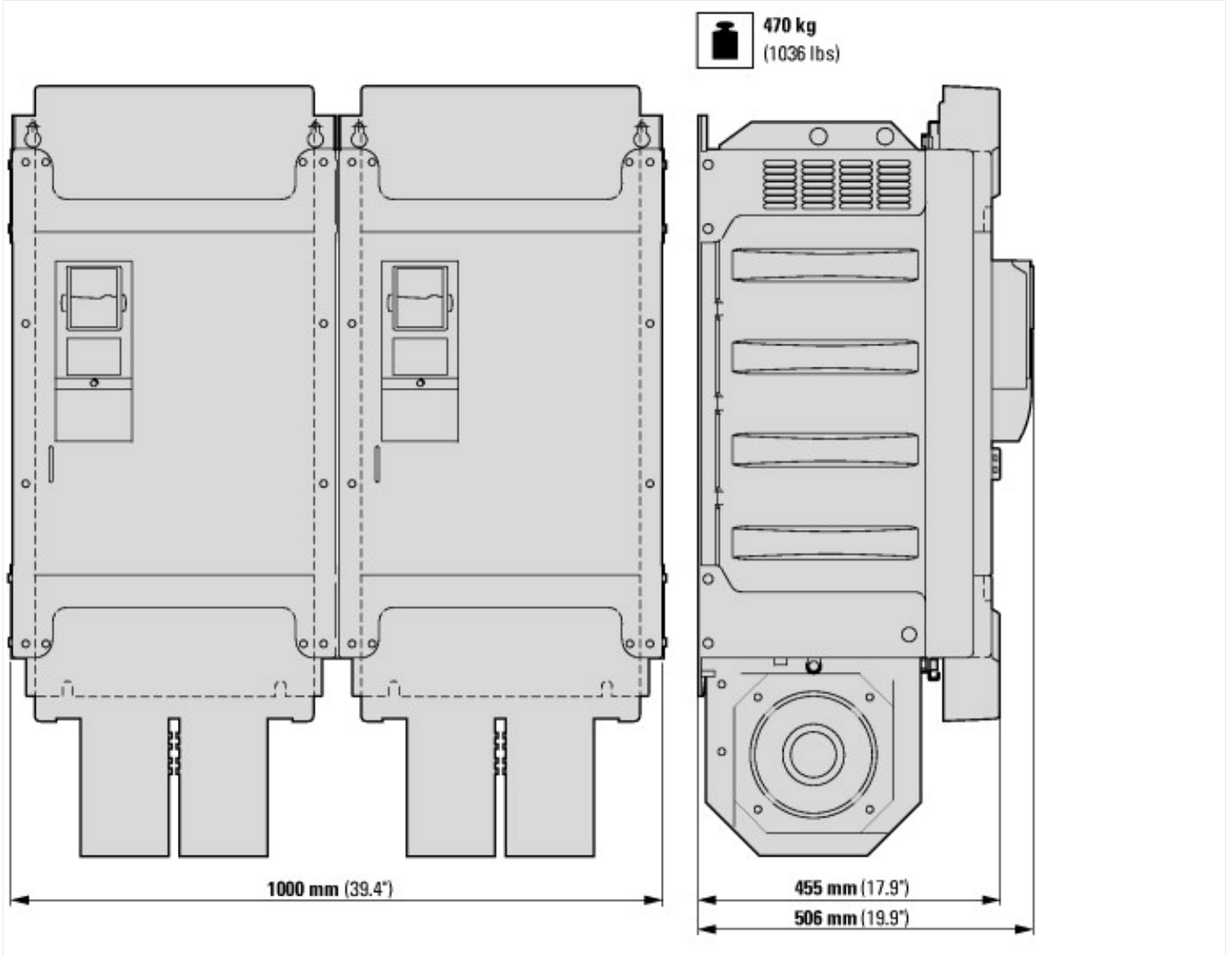

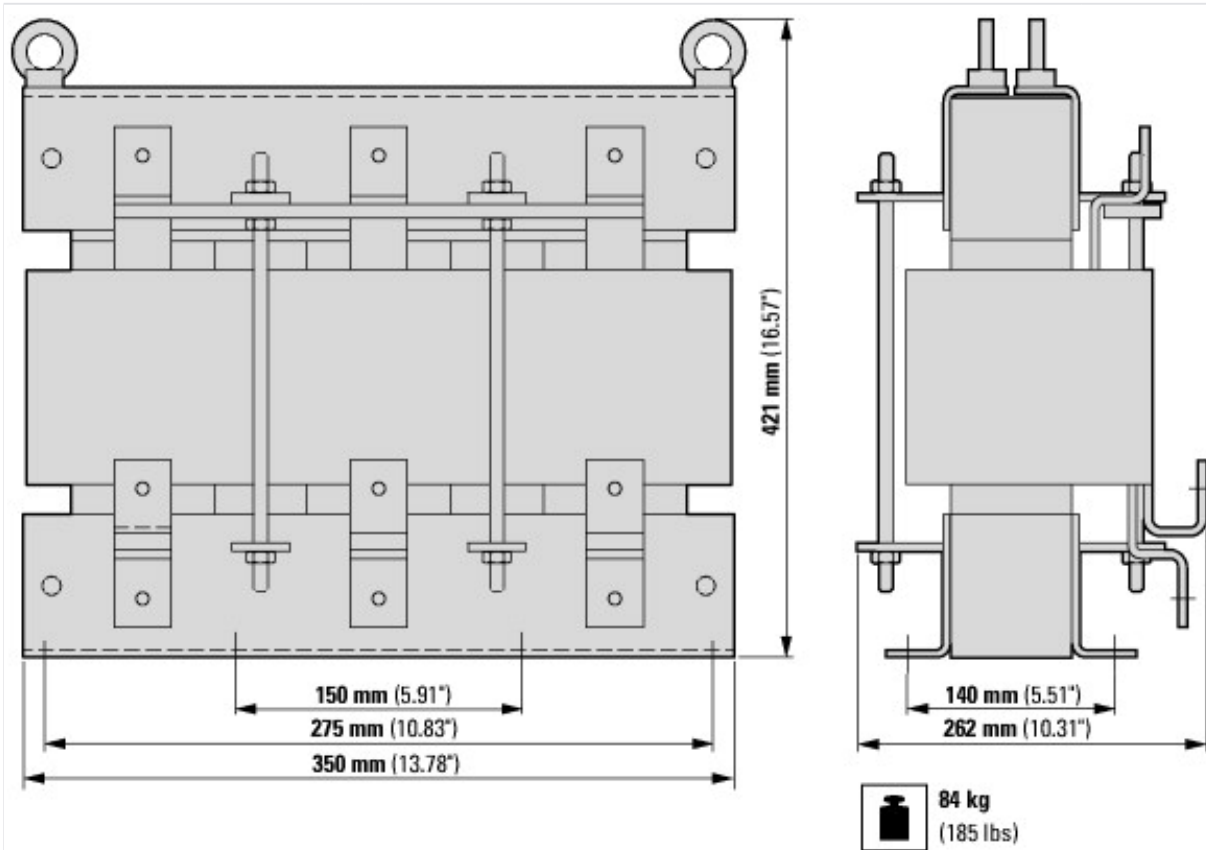

2x CHK0400 mains choke

## Assets (links)

### Declaration of CE Conformity

00002807

### Instruction Leaflets

IL04020008Z2018\_05

## Additional product information (links)

### IL04020008Z Frequency inverter 9000X

IL04020008Z Frequency inverter 9000X

[ftp://ftp.moeller.net/DOCUMENTATION/AWA\\_INSTRUCTIONS/IL04020008Z2018\\_05.pdf](ftp://ftp.moeller.net/DOCUMENTATION/AWA_INSTRUCTIONS/IL04020008Z2018_05.pdf)

Documentation

<http://www.eaton.eu/Europe/Electrical/ProductsServices/AutomationControl/SwitchingProtectingDrivingMotors/9000X/SPX9000/index.htm#tabs-4>