





Circuit-breaker, 3p, 50A, plug-in module

Part no. **NZMH1-S50-SVE**  
 Catalog No. **112806**

Similar to illustration

## Delivery program

Product range				Circuit-breaker
Protective function				Short-circuit protection
Standard/Approval				IEC
Installation type				Plug-in units
Release system				Thermomagnetic release
Construction size				NZM1
Description				Motor protection in conjunction with overload relay With short-circuit release Without overload release I <sub>r</sub> IEC/EN 60947-4-1, IEC/EN 60947-2  The circuit-breaker fulfills all requirements for AC-3 switching category.
Number of poles				3 pole
Standard equipment				Box terminal
Rated current = rated uninterrupted current	$I_n = I_u$	A		50
<b>Switching capacity</b>				
400/415 V 50 Hz	$I_{cu}$	kA		100
<b>Setting range</b>				
Short-circuit releases				
				
Non-delayed				
				
	$I_i = I_n \times \dots$			8 - 14
<b>Motor rating AC-3 at 400 V 50/60 Hz</b>				
380 V 400 V	P	kW		22
<b>Rated operational current AC-3 at 400 V 50/60 Hz</b>				
400 V	$I_e$	A		41

## Technical data

### General

Standards				IEC/EN 60947
Protection against direct contact				Finger and back of hand proof to VDE 0106 Part 100
Climatic proofing				Damp heat, constant, to IEC 60068-2-78 Damp heat, cyclic, to IEC 60068-2-30
Ambient temperature				
Ambient temperature, storage		°C		- 40 - + 70
Operation		°C		-25 - +70
Mechanical shock resistance (10 ms half-sinusoidal shock) according to IEC 60068-2-27		g		20 (half-sinusoidal shock 20 ms)
Safe isolation to EN 61140				
Between auxiliary contacts and main contacts		V AC		500
between the auxiliary contacts		V AC		300
Mounting position				Vertical and 90° in all directions



With XFI earth-fault release:  
 - NZM1, N1, NZM2, N2: vertical and 90° in all directions  
 with plug-in unit  
 - NZM1, N1, NZM2, N2: vertical, 90° right/left  
 with withdrawable unit:  
 - NZM3, N3: vertical, 90° right/left  
 - NZM4, N4: vertical  
 with remote operator:  
 - NZM2, N(S)2, NZM3, N(S)3, NZM4, N(S)4: vertical and 90° in all directions

Direction of incoming supply		as required
Degree of protection		
Device		In the operating controls area: IP20 (basic degree of protection)
Enclosures		With insulating surround: IP40 With door coupling rotary handle: IP66
Terminations		Tunnel terminal: IP10 Phase isolator and strip terminal: IP00
Other technical data (sheet catalogue)		Temperature dependency, Derating

### Circuit-breakers

Rated current = rated uninterrupted current	$I_n = I_u$	A	50
Rated surge voltage invariability	$U_{imp}$		
Main contacts		V	6000
Auxiliary contacts		V	6000
Rated operational voltage	$U_e$	V AC	690
Overvoltage category/pollution degree			III/3
Rated insulation voltage	$U_i$	V	690
Use in unearthed supply systems		V	≤ 690

### Switching capacity

Rated short-circuit making capacity	$I_{cm}$		
240 V	$I_{cm}$	kA	220
400/415 V	$I_{cm}$	kA	220
440 V 50/60 Hz	$I_{cm}$	kA	74
525 V 50/60 Hz	$I_{cm}$	kA	40
690 V 50/60 H	$I_c$	kA	17
Rated short-circuit breaking capacity $I_{cn}$	$I_{cn}$		
$I_{cu}$ to IEC/EN 60947 test cycle O-t-CO	$I_{cu}$	kA	
240 V 50/60 Hz	$I_{cu}$	kA	100
400/415 V 50/60 Hz	$I_{cu}$	kA	100
440 V 50/60 Hz	$I_{cu}$	kA	70
525 V 50/60 Hz	$I_{cu}$	kA	20
690 V 50/60 Hz	$I_{cu}$	kA	10
$I_{cs}$ to IEC/EN 60947 test cycle O-t-CO-t-CO	$I_{cs}$	kA	
240 V 50/60 Hz	$I_{cs}$	kA	100
400/415 V 50/60 Hz	$I_{cs}$	kA	50
440 V 50/60 Hz	$I_{cs}$	kA	35
525 V 50/60 Hz	$I_{cs}$	kA	10
690 V 50/60 Hz	$I_{cs}$	kA	7.5
			Maximum back-up fuse, if the expected short-circuit currents at the installation location exceed the switching capacity of the circuit-breaker.
Utilization category to IEC/EN 60947-2			A
Lifespan, mechanical(of which max. 50 % trip by shunt/undervoltage release)	Operations		20000
Lifespan, electrical			
AC-1			
400 V 50/60 Hz	Operations		10000
415 V 50/60 Hz	Operations		10000
690 V 50/60 Hz	Operations		7500
AC--3			

400 V 50/60 Hz	Operations	7500
415 V 50/60 Hz	Operations	7500
690 V 50/60 Hz	Operations	5000
Max. operating frequency	Ops/h	120
Total break time at short-circuit	ms	< 10

### Terminal capacity

Standard equipment			Box terminal
Accessories required			NZM1-XSVS
Optional accessories			Screw connection Tunnel terminal connection on rear
Round copper conductor			
Box terminal			
Solid		mm <sup>2</sup>	1 x (10 - 16) 2 x (6 - 16)
Stranded		mm <sup>2</sup>	1 x (10 - 70) <sup>3)</sup> 2 x (6-25)
			<sup>3)</sup> Up to 95 mm <sup>2</sup> can be connected depending on the cable manufacturer.
Tunnel terminal			
Solid		mm <sup>2</sup>	1 x 16
Stranded			
1-hole		mm <sup>2</sup>	1 x (25 - 95)
Bolt terminal and rear-side connection			
Direct on the switch			
Solid		mm <sup>2</sup>	1 x (10 - 16) 2 x (6 - 16)
Stranded		mm <sup>2</sup>	1 x (10 - 70) <sup>3)</sup> 2 x 25
			<sup>3)</sup> Up to 95 mm <sup>2</sup> can be connected depending on the cable manufacturer.
Al circular conductor			
Tunnel terminal			
Solid		mm <sup>2</sup>	1 x 16
Stranded			
Stranded		mm <sup>2</sup>	1 x (25 - 95)
Bolt terminal and rear-side connection			
Direct on the switch			
Solid		mm <sup>2</sup>	1 x (10 - 16) 2 x (10 - 16)
Stranded		mm <sup>2</sup>	1 x (25 - 35) 2 x (25 - 35)
Cu strip (number of segments x width x segment thickness)			
Box terminal			
	min.	mm	2 x 9 x 0.8
	max.	mm	9 x 9 x 0.8
Copper busbar (width x thickness)	mm		
Bolt terminal and rear-side connection			
Screw connection			M6
Direct on the switch			
	min.	mm	12 x 5
	max.	mm	16 x 5
Control cables			
		mm <sup>2</sup>	1 x (0.75 - 2.5) 2 x (0.75 - 1.5)

### Design verification as per IEC/EN 61439

Technical data for design verification			
Rated operational current for specified heat dissipation	I <sub>n</sub>	A	50
Equipment heat dissipation, current-dependent	P <sub>vid</sub>	W	13.2

Operating ambient temperature min.	°C	-25
Operating ambient temperature max.	°C	70
IEC/EN 61439 design verification		
10.2 Strength of materials and parts		
10.2.2 Corrosion resistance		Meets the product standard's requirements.
10.2.3.1 Verification of thermal stability of enclosures		Meets the product standard's requirements.
10.2.3.2 Verification of resistance of insulating materials to normal heat		Meets the product standard's requirements.
10.2.3.3 Verification of resistance of insulating materials to abnormal heat and fire due to internal electric effects		Meets the product standard's requirements.
10.2.4 Resistance to ultra-violet (UV) radiation		Meets the product standard's requirements.
10.2.5 Lifting		Does not apply, since the entire switchgear needs to be evaluated.
10.2.6 Mechanical impact		Does not apply, since the entire switchgear needs to be evaluated.
10.2.7 Inscriptions		Meets the product standard's requirements.
10.3 Degree of protection of ASSEMBLIES		Does not apply, since the entire switchgear needs to be evaluated.
10.4 Clearances and creepage distances		Meets the product standard's requirements.
10.5 Protection against electric shock		Does not apply, since the entire switchgear needs to be evaluated.
10.6 Incorporation of switching devices and components		Does not apply, since the entire switchgear needs to be evaluated.
10.7 Internal electrical circuits and connections		Is the panel builder's responsibility.
10.8 Connections for external conductors		Is the panel builder's responsibility.
10.9 Insulation properties		
10.9.2 Power-frequency electric strength		Is the panel builder's responsibility.
10.9.3 Impulse withstand voltage		Is the panel builder's responsibility.
10.9.4 Testing of enclosures made of insulating material		Is the panel builder's responsibility.
10.10 Temperature rise		The panel builder is responsible for the temperature rise calculation. Eaton will provide heat dissipation data for the devices.
10.11 Short-circuit rating		Is the panel builder's responsibility. The specifications for the switchgear must be observed.
10.12 Electromagnetic compatibility		Is the panel builder's responsibility. The specifications for the switchgear must be observed.
10.13 Mechanical function		The device meets the requirements, provided the information in the instruction leaflet (IL) is observed.

## Technical data ETIM 7.0

Low-voltage industrial components (EG000017) / Motor protection circuit-breaker (EC000074)		
Electric engineering, automation, process control engineering / Low-voltage switch technology / Circuit breaker (LV < 1 kV) / Motor protection circuit-breaker (ecl@ss10.0.1-27-37-04-01 [AGZ529016])		
Overload release current setting	A	0 - 0
Adjustment range undelayed short-circuit release	A	8 - 14
With thermal protection		No
Phase failure sensitive		No
Switch off technique		Magnetic
Rated operating voltage	V	690 - 690
Rated permanent current I <sub>u</sub>	A	50
Rated operation power at AC-3, 230 V	kW	15
Rated operation power at AC-3, 400 V	kW	22
Type of electrical connection of main circuit		Other
Type of control element		Rocker lever
Device construction		Built-in device plug-in technique
With integrated auxiliary switch		No
With integrated under voltage release		No
Number of poles		3
Rated short-circuit breaking capacity I <sub>cu</sub> at 400 V, AC	kA	100
Degree of protection (IP)		IP20
Height	mm	145
Width	mm	90
Depth	mm	84.5

## Dimensions

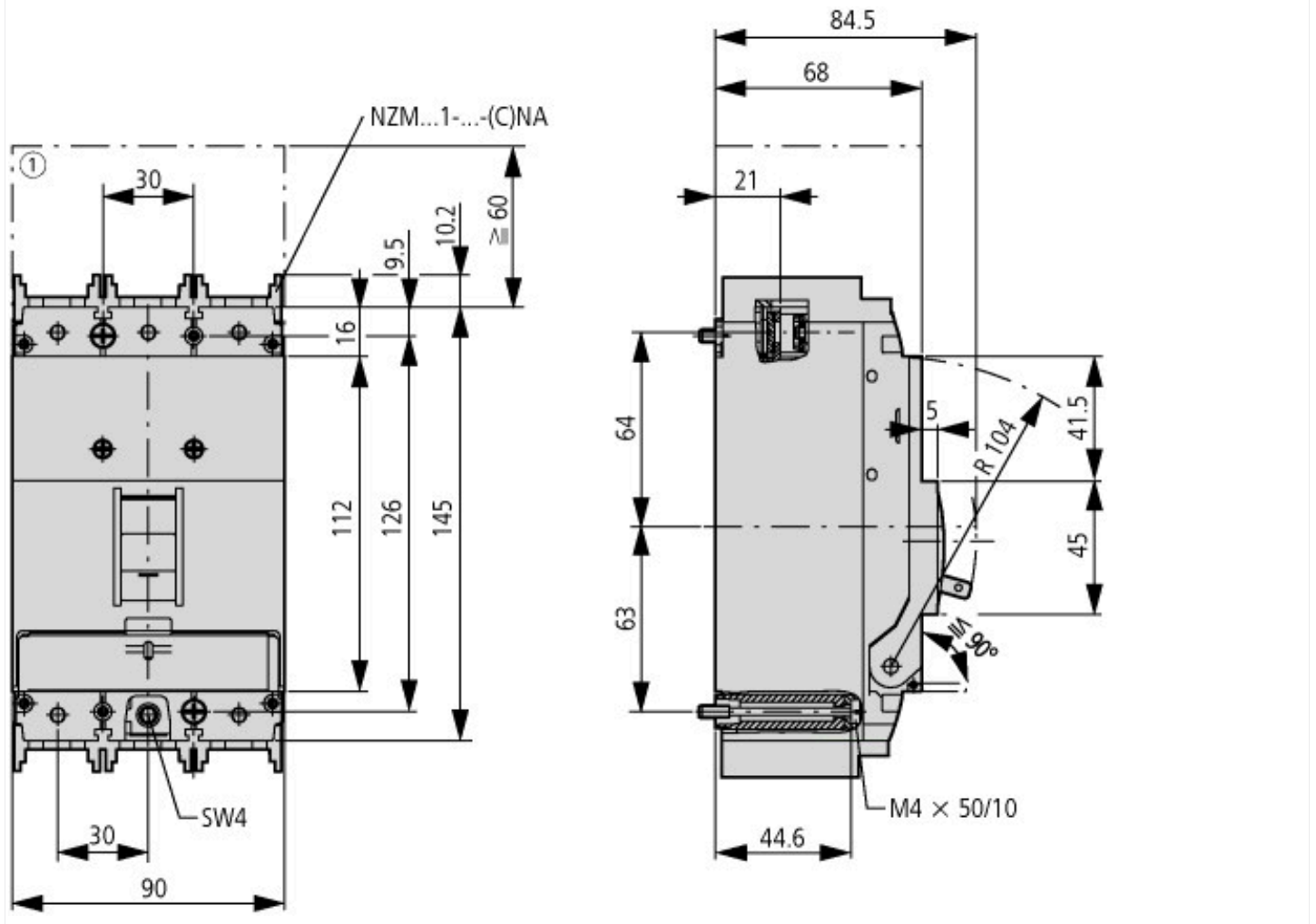

① Blow out area, minimum clearance to adjacent parts

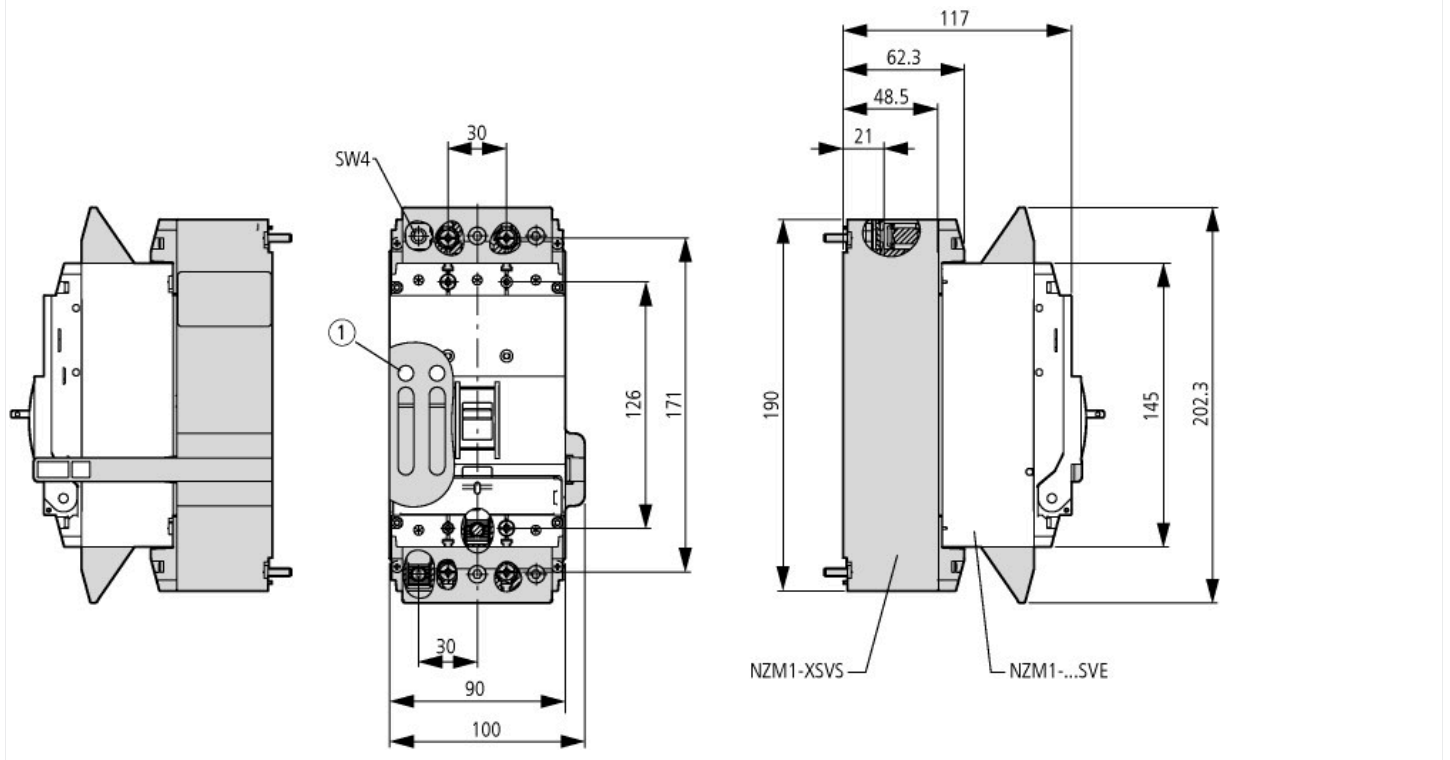

## Additional product information (links)

**IL01203004Z (AWA1230-1913) Circuit-breaker, Switch-Disconnecter**

IL01203004Z (AWA1230-1913) Circuit-breaker, Switch-Disconnecter [ftp://ftp.moeller.net/DOCUMENTATION/AWA\\_INSTRUCTIONS/IL01203004Z2015\\_11.pdf](ftp://ftp.moeller.net/DOCUMENTATION/AWA_INSTRUCTIONS/IL01203004Z2015_11.pdf)

**IL01219023Z (AWA1230-2052) Plug-in adapter**

IL01219023Z (AWA1230-2052) Plug-in adapter [ftp://ftp.moeller.net/DOCUMENTATION/AWA\\_INSTRUCTIONS/IL01219023Z2016\\_02.pdf](ftp://ftp.moeller.net/DOCUMENTATION/AWA_INSTRUCTIONS/IL01219023Z2016_02.pdf)

Temperature dependency, Derating	<a href="http://ecat.moeller.net/flip-cat/?edition=HPLEN&amp;startpage=17.172">http://ecat.moeller.net/flip-cat/?edition=HPLEN&amp;startpage=17.172</a>
CurveSelect characteristics program	<a href="http://www.eaton.eu/DE/Europe/Electrical/CustomerSupport/ConfigurationTools/CharacteristicsProgram/index.htm">http://www.eaton.eu/DE/Europe/Electrical/CustomerSupport/ConfigurationTools/CharacteristicsProgram/index.htm</a>
Eaton configurator	<a href="http://www.eaton.eu/DE/Europe/Electrical/CustomerSupport/ConfigurationTools/ConfiguratorCircuitBreaker/index.htm">http://www.eaton.eu/DE/Europe/Electrical/CustomerSupport/ConfigurationTools/ConfiguratorCircuitBreaker/index.htm</a>
additional technical information for NZM power switch	<a href="ftp://ftp.moeller.net/DOCUMENTATION/PDF/nzm_technic_de_en.pdf">ftp://ftp.moeller.net/DOCUMENTATION/PDF/nzm_technic_de_en.pdf</a>