



Spare nut, Stainless steel, M18 sensors

Part no. E57KNS18
Catalog No. 136196
Alternate Catalog No. E57KNS18

Delivery program

Basic function			Accessories
Accessories			Replacement nuts
Material			Stainless steel
For use with			
For use with			M18 sensors

Design verification as per IEC/EN 61439

Technical data for design verification			
Operating ambient temperature min.		°C	-25
Operating ambient temperature max.		°C	70

Technical data ETIM 7.0

Sensors (EG000026) / Accessories for position switches (EC002594)			
Electric engineering, automation, process control engineering / Binary sensor technology, safety-related sensor technology / Position switch / Position switch (accessories) (ecl@ss10.0.1-27-27-06-92 [AFR520003])			
Type of accessory			Other

Approvals

Product Standards			none
-------------------	--	--	------

Dimensions

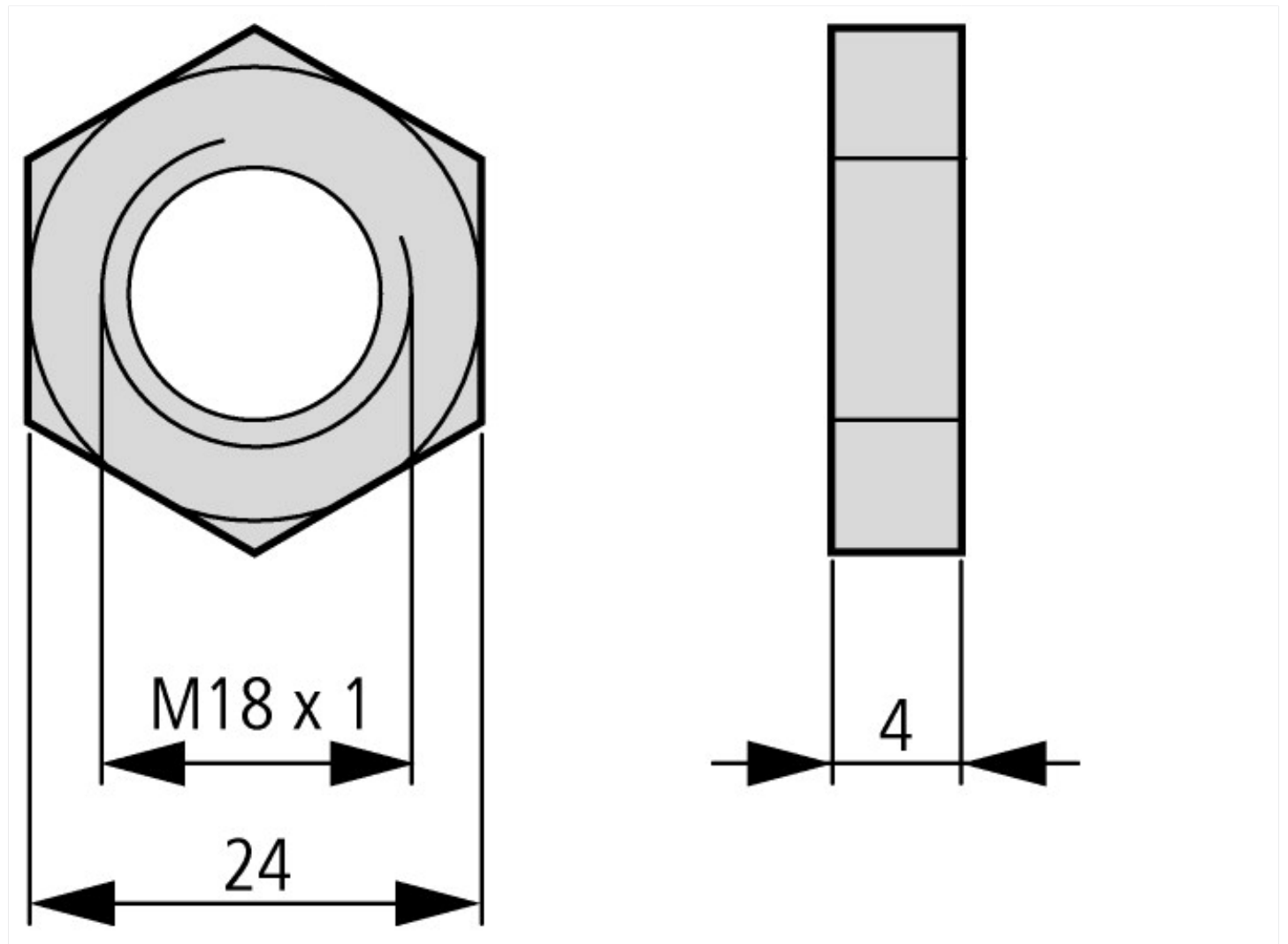

Assets (links)

[Declaration of CE Conformity](#)

00003158