

Cable adapter, Metal, M8 sensors

Part no. E57KC8
 Catalog No. 136187
 Alternate Catalog No. E57KC8

Delivery program

Basic function			Accessories
Accessories			Conduit adapter
Material			Metal
For use with			
For use with			M8 sensors

Design verification as per IEC/EN 61439

Technical data for design verification			
Operating ambient temperature min.		°C	-25
Operating ambient temperature max.		°C	70

Technical data ETIM 7.0

Sensors (EG000026) / Accessories for position switches (EC002594)			
Electric engineering, automation, process control engineering / Binary sensor technology, safety-related sensor technology / Position switch / Position switch (accessories) (ecl@ss10.0.1-27-27-06-92 [AFR520003])			
Type of accessory			Other

Approvals

Product Standards			none
-------------------	--	--	------

Dimensions

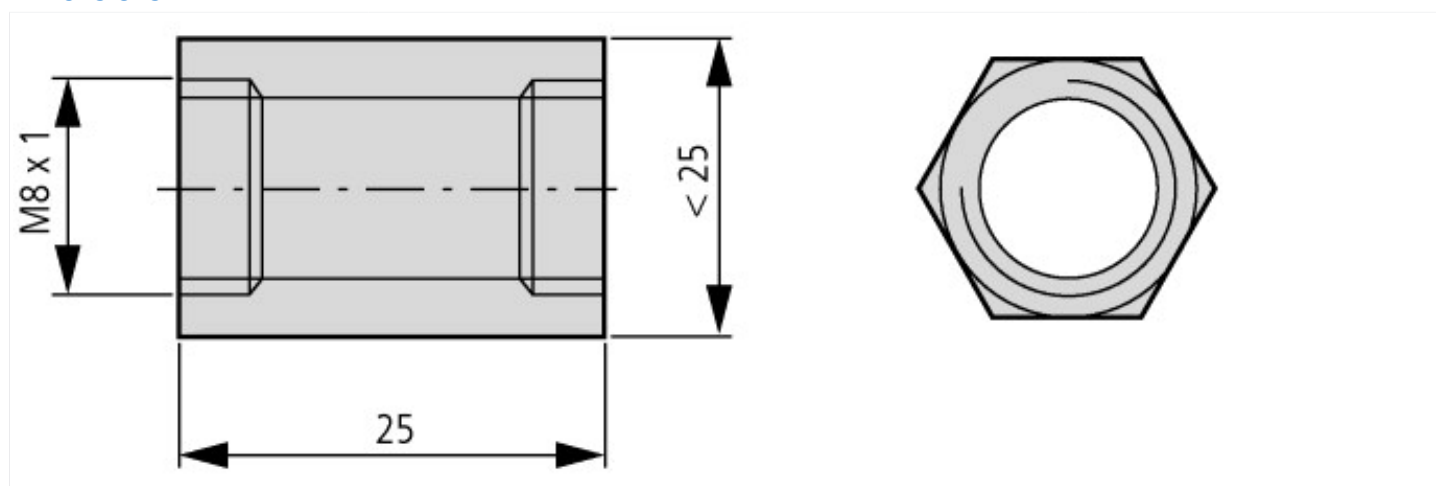

Assets (links)

Declaration of CE Conformity

00003158