



Variable frequency drive, 400 V AC, 3-phase, 72 A, IP54, Radio interference suppression filter, OLED display, FR7

Part no. SVX050A2-4A1N1
Catalog No. 125697
Alternate Catalog No. SVX050A2-4A1N1
EL-Nummer (Norway) 4132572

Delivery program

Product range			Variable frequency drives
Part group reference (e.g. DIL)			SVX
Rated operational voltage	U _e		400 V AC, 3-phase 480 V AC, 3-phase 500 V AC, 3-phase
Output voltage with V _e	U ₂		400 V AC, 3-phase 480 V AC, 3-phase 500 V AC, 3-phase
Mains voltage (50/60Hz)	U _{LN}	V	380 (-15%) - 500 (+10%)
Rated operational current			
At 150% overload	I _e	A	72
At 110% overload	I _e	A	87
Assigned motor rating			
Note			For AC motors with internal and external ventilation with 50 Hz / 60 Hz
Note			Overload cycle for 60 s every 600 s
Note			at 400 V, 50 Hz
150 % Overload	P	kW	37
110 % Overload	P	kW	45
150 % Overload	I _M	A	68
110 % Overload	I _M	A	81
Note			at 440 - 480 V, 60 Hz
150 % Overload	P	HP	50
110 % Overload	P	HP	60
150 % Overload	I _M	A	65
110 % Overload	I _M	A	77
Degree of Protection			IP54
Fieldbus connection (optional)			PROFIBUS-DP PROFINET EtherCAT EtherNet/IP LonWorks CANopen® DeviceNet Modbus-TCP Modbus-RTU BACnet MS/TP
Fitted with			Radio interference suppression filter OLED display
Frame size			FR7
Connection to SmartWire-DT			no

Technical data

General			
Standards			Specification for general requirements: IEC/EN 61800-2 EMC requirements: IEC/EN 61800-3 Safety requirements: IEC/EN 61800-5-1
Certifications			CE, UL, cUL, RCM
Approvals			DNV

Production quality			RoHS, ISO 9001
Climatic proofing	ρ_w	%	< 95% relative humidity, no condensation, no corrosion, no dripping water
Ambient temperature			
Operating ambient temperature min.		°C	-10
Operating ambient temperature max.		°C	+ 50
operation (110 % overload)	θ	°C	-10 - +40
Storage	θ	°C	-40 - +70
Radio interference level			
Radio interference class (EMC)			C2, C3, depending on the motor cable length, the connected load, and ambient conditions. External radio interference suppression filters (optional) may be necessary.
Environment (EMC)			1st and 2nd environments as per EN 61800-3
Mounting position			Vertical
Altitude		m	0 - 1000 m above sea level above 1000 m with 1 % performance reduction per 100 m max. 3000 m
Degree of Protection			IP54
Protection against direct contact			BGV A3 (VBG4, finger- and back-of-hand proof)

Main circuit

Supply			
Rated operational voltage	U_e		400 V AC, 3-phase 480 V AC, 3-phase 500 V AC, 3-phase
Mains voltage (50/60Hz)	U_{LN}	V	380 (-15%) - 500 (+10%)
System configuration			AC supply systems with earthed center point
Supply frequency	f_{LN}	Hz	50/60
Frequency range	f_{LN}	Hz	45–66 (\pm 0%)
Power section			
Function			Variable frequency drive with internal DC link and IGBT inverter
Output voltage with V_e	U_2		400 V AC, 3-phase 480 V AC, 3-phase 500 V AC, 3-phase
Output Frequency	f_2	Hz	0 - 50/60 (max. 320)
Switching frequency	f_{PWM}	kHz	3.6 adjustable 1 - 10
Operation Mode			U/f control sensorless vector control (SLV)
Frequency resolution (setpoint value)	Δf	Hz	0.01
Rated operational current			
At 150% overload	I_e	A	72
At 110% overload	I_e	A	87
Fitted with			Radio interference suppression filter OLED display
Frame size			FR7
Motor feeder			
Note			For AC motors with internal and external ventilation with 50 Hz / 60 Hz
Note			Overload cycle for 60 s every 600 s
Note			at 400 V, 50 Hz
150 % Overload	P	kW	37
110 % Overload	P	kW	45
Note			at 440 - 480 V, 60 Hz
150 % Overload	P	HP	50
110 % Overload	P	HP	60

Control section

External control voltage	U_c	V	24 V DC (max. 250 mA)
Reference voltage	U_s	V	10 V DC (max. 10 mA)
Analog inputs			2, parameterizable, 0 - 10 V DC, 0/4 - 20 mA
Analog outputs			1, parameterizable, 0/4 - 20 mA
Digital inputs			6, parameterizable, max. 30 V DC
Digital outputs			1, parameterizable, 48 V DC/50 mA

Relay outputs			2, parameterizable, N/O, 8 A (24 V DC) / 8 A (250 V AC) / 0,4 A (125 V DC)
Assigned switching and protective elements			
Power Wiring			
Main choke			
150 % overload (CT/I _H , at 50 °C)			DX-LN3-100
Motor feeder			
motor choke			
150 % overload (CT/I _H , at 50 °C)			DX-LM3-080
110 % overload (VT/I _L , at 40 °C)			DX-LM3-100
Sine filter			
150 % overload (CT/I _H , at 50 °C)			DX-SIN3-072
110 % overload (VT/I _L , at 40 °C)			DX-SIN3-090

Design verification as per IEC/EN 61439

Technical data for design verification			
Rated operational current for specified heat dissipation	I _n	A	72
Heat dissipation per pole, current-dependent	P _{vid}	W	0
Equipment heat dissipation, current-dependent	P _{vid}	W	925
Static heat dissipation, non-current-dependent	P _{vs}	W	0
Heat dissipation capacity	P _{diss}	W	0
Operating ambient temperature min.		°C	-10
Operating ambient temperature max.		°C	50
IEC/EN 61439 design verification			
10.2 Strength of materials and parts			
10.2.2 Corrosion resistance			Meets the product standard's requirements.
10.2.3.1 Verification of thermal stability of enclosures			Meets the product standard's requirements.
10.2.3.2 Verification of resistance of insulating materials to normal heat			Meets the product standard's requirements.
10.2.3.3 Verification of resistance of insulating materials to abnormal heat and fire due to internal electric effects			Meets the product standard's requirements.
10.2.4 Resistance to ultra-violet (UV) radiation			Meets the product standard's requirements.
10.2.5 Lifting			Does not apply, since the entire switchgear needs to be evaluated.
10.2.6 Mechanical impact			Does not apply, since the entire switchgear needs to be evaluated.
10.2.7 Inscriptions			Meets the product standard's requirements.
10.3 Degree of protection of ASSEMBLIES			Does not apply, since the entire switchgear needs to be evaluated.
10.4 Clearances and creepage distances			Meets the product standard's requirements.
10.5 Protection against electric shock			Does not apply, since the entire switchgear needs to be evaluated.
10.6 Incorporation of switching devices and components			Does not apply, since the entire switchgear needs to be evaluated.
10.7 Internal electrical circuits and connections			Is the panel builder's responsibility.
10.8 Connections for external conductors			Is the panel builder's responsibility.
10.9 Insulation properties			
10.9.2 Power-frequency electric strength			Is the panel builder's responsibility.
10.9.3 Impulse withstand voltage			Is the panel builder's responsibility.
10.9.4 Testing of enclosures made of insulating material			Is the panel builder's responsibility.
10.10 Temperature rise			The panel builder is responsible for the temperature rise calculation. Eaton will provide heat dissipation data for the devices.
10.11 Short-circuit rating			Is the panel builder's responsibility. The specifications for the switchgear must be observed.
10.12 Electromagnetic compatibility			Is the panel builder's responsibility. The specifications for the switchgear must be observed.
10.13 Mechanical function			The device meets the requirements, provided the information in the instruction leaflet (IL) is observed.

Approvals

Product Standards			UL 508C; CSA-C22.2 No. 14; IEC/EN61800-3; IEC/EN61800-5; CE marking
UL File No.			E134360
UL Category Control No.			NMMS, NMMS2, NMMS7, NMMS8
CSA File No.			UL report applies to both US and Canada

CSA Class No.		3211-06
North America Certification		UL listed, certified by UL for use in Canada
Specially designed for North America		No
Suitable for		Branch circuits
Max. Voltage Rating		3~ 480 V AC IEC: TN-S UL/CSA: "Y" (Solidly Grounded Wey)
Degree of Protection		IEC: IP54

Dimensions

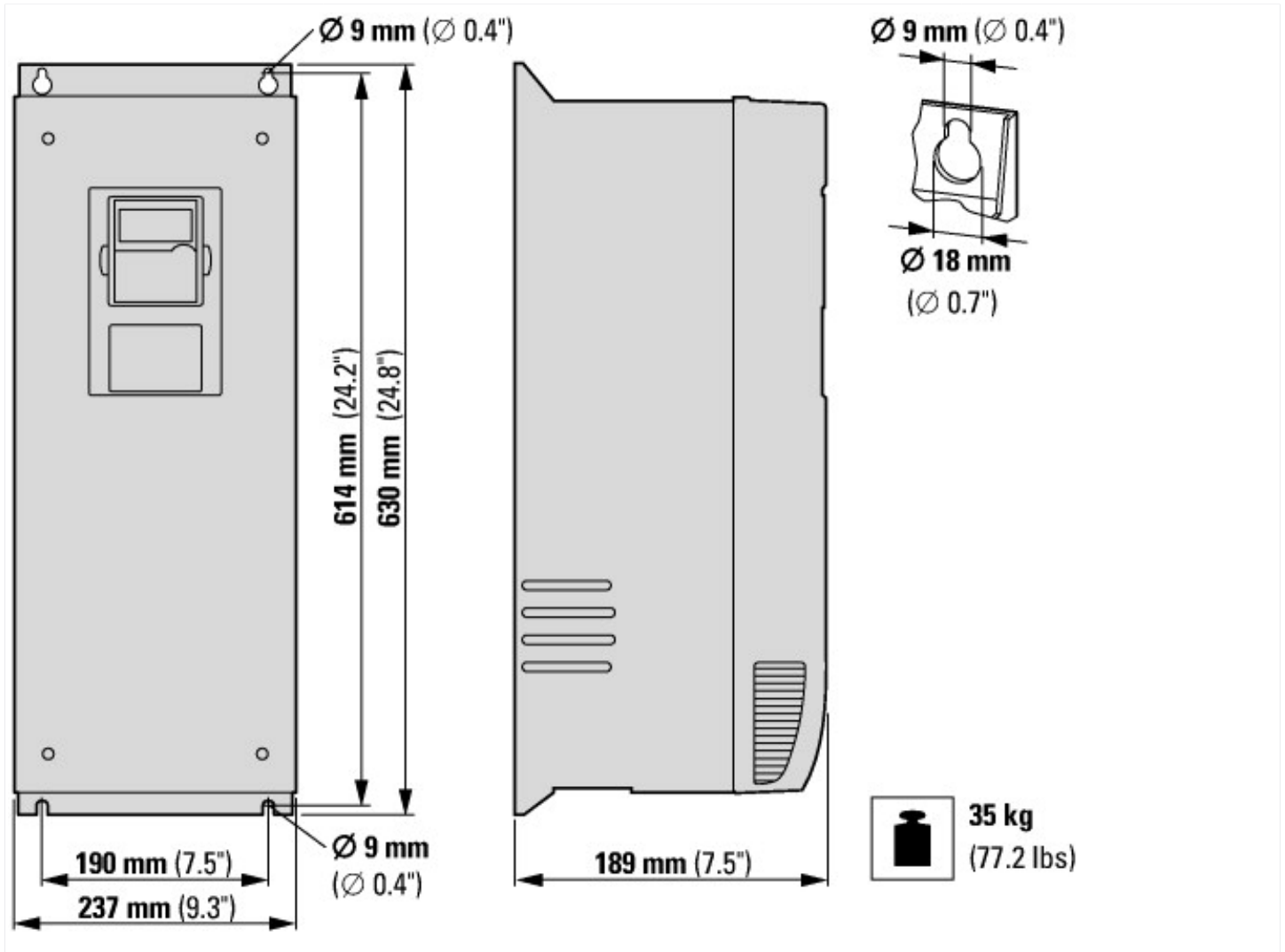

Assets (links)

Declaration of CE Conformity

00002807

Instruction Leaflets

IL04020008Z2018_05

Additional product information (links)

IL04020008Z Frequency inverter 9000X	
IL04020008Z Frequency inverter 9000X	ftp://ftp.moeller.net/DOCUMENTATION/AWA_INSTRUCTIONS/IL04020008Z2018_05.pdf
Documentation	http://www.eaton.eu/Europe/Electrical/ProductsServices/AutomationControl/SwitchingProtectingDrivingMotors/9000X/SVX9000/index.htm#tabs-4