



Three-phase control isolating safety transformer, 0.4 kVA, Rated input voltage 50 – 950 ± 5 % V, Rated output voltage 18.5 – 1000 V

Part no. DTZ0,4(*/*)*
Catalog No. 914802
Alternate Catalog No. -

Delivery program

Product range		Three-phase DTZ control transformers
Rated input voltage	V	50 – 950 ± 5 %
Rated output voltage	V	18.5 – 1000
Rated power	kVA	0.4
Short-time rating	kVA	0.8
Cu factor 1,10		

Notes

- Transformers with the rated output voltages ≤ 50 V can be used as safety transformers to IEC/EN 61558.
- UL/CSA only up to primary and secondary 600 V (incl. tapping).
- Enclosures IP65 on request.

When ordering, the type reference must include the following details:

DTZ0,1(*/*)*

1st wildcard ≙ Nominal input voltage

2nd wildcard ≙ Rated output voltage

3rd wildcard ≙ Configuration

Ordering example

- Desired part no. DTZ0,1
- Desired rated input voltage 200 V
- Desired rated output voltage 18.5 V
- Desired configuration Dy(n)5

The correct type reference is

DTZ0,1(200/18,5)DY(N)5

Additional tappings → 931897

Design verification as per IEC/EN 61439

Technical data for design verification			
Rated operational current for specified heat dissipation	I _n	A	0
Heat dissipation per pole, current-dependent	P _{vid}	W	0
Equipment heat dissipation, current-dependent	P _{vid}	W	0
Static heat dissipation, non-current-dependent	P _{vs}	W	55
Heat dissipation capacity	P _{diss}	W	0
Operating ambient temperature min.		°C	-25
Operating ambient temperature max.		°C	40
IEC/EN 61439 design verification			
10.2 Strength of materials and parts			
10.2.2 Corrosion resistance			Meets the product standard's requirements.
10.2.3.1 Verification of thermal stability of enclosures			Meets the product standard's requirements.
10.2.3.2 Verification of resistance of insulating materials to normal heat			Meets the product standard's requirements.
10.2.3.3 Verification of resistance of insulating materials to abnormal heat and fire due to internal electric effects			Meets the product standard's requirements.
10.2.4 Resistance to ultra-violet (UV) radiation			Meets the product standard's requirements.
10.2.5 Lifting			Does not apply, since the entire switchgear needs to be evaluated.
10.2.6 Mechanical impact			Does not apply, since the entire switchgear needs to be evaluated.
10.2.7 Inscriptions			Meets the product standard's requirements.

10.3 Degree of protection of ASSEMBLIES		Does not apply, since the entire switchgear needs to be evaluated.
10.4 Clearances and creepage distances		Meets the product standard's requirements.
10.5 Protection against electric shock		Does not apply, since the entire switchgear needs to be evaluated.
10.6 Incorporation of switching devices and components		Does not apply, since the entire switchgear needs to be evaluated.
10.7 Internal electrical circuits and connections		Is the panel builder's responsibility.
10.8 Connections for external conductors		Is the panel builder's responsibility.
10.9 Insulation properties		
10.9.2 Power-frequency electric strength		Is the panel builder's responsibility.
10.9.3 Impulse withstand voltage		Is the panel builder's responsibility.
10.9.4 Testing of enclosures made of insulating material		Is the panel builder's responsibility.
10.10 Temperature rise		The panel builder is responsible for the temperature rise calculation. Eaton will provide heat dissipation data for the devices.
10.11 Short-circuit rating		Is the panel builder's responsibility. The specifications for the switchgear must be observed.
10.12 Electromagnetic compatibility		Is the panel builder's responsibility. The specifications for the switchgear must be observed.
10.13 Mechanical function		The device meets the requirements, provided the information in the instruction leaflet (IL) is observed.

Technical data ETIM 7.0

Low-voltage industrial components (EG000017) / Three-phase control transformer (EC002485)		
Electric engineering, automation, process control engineering / Transformer, converter, coil / Control transformer / Three-phase control transformer (ec1@ss10.0.1-27-03-13-01 [AAB619015])		
Built as safety transformer		Yes
Built as isolating transformer		Yes
Built as energy saving transformer		No
Primary voltage 1	V	50 - 950
Primary voltage 2	V	50 - 950
Primary voltage 3	V	50 - 950
Primary voltage 4	V	50 - 950
Primary voltage 5	V	50 - 950
Primary voltage 6	V	50 - 950
Primary voltage 7	V	0 - 0
Primary voltage 8	V	0 - 0
Primary voltage 9	V	0 - 0
Primary voltage 10	V	0 - 0
Secondary voltage 1	V	18.5 - 1000
Secondary voltage 2	V	18.5 - 1000
Secondary voltage 3	V	18.5 - 1000
Secondary voltage 4	V	18.5 - 1000
Secondary voltage 5	V	18.5 - 1000
Secondary voltage 6	V	18.5 - 1000
Secondary voltage 7	V	0 - 0
Secondary voltage 8	V	0 - 0
Secondary voltage 9	V	0 - 0
Secondary voltage 10	V	0 - 0
Wiring system		Other
Rated power	VA	400
Type of insulation material acc. IEC 85		B
Short-circuit-proof		No
Relative short circuit voltage	%	8
Conductor material		Copper
Width	mm	155
Height	mm	164
Depth	mm	92
Degree of protection (IP)		IP00
Degree of protection (NEMA)		Other

Approvals

Product Standards	UL 506; UL5085-1; UL 5085-2; CSA-C22.2 No. 66; CSA-C22.2 No. 66.1-06; CSA-C22.2 No. 66.2-06; IEC/EN 61558-2-2; CE marking
UL File No.	E167225
UL Category Control No.	XPTQ2, XPTQ8
CSA File No.	UL report applies to both US and Canada
CSA Class No.	-
North America Certification	UL recognized, certified by UL for use in Canada
Specially designed for North America	No
Suitable for	Branch circuits
Max. Voltage Rating	600 V AC
Degree of Protection	IEC: IP00, UL/CSA Type: -

Dimensions

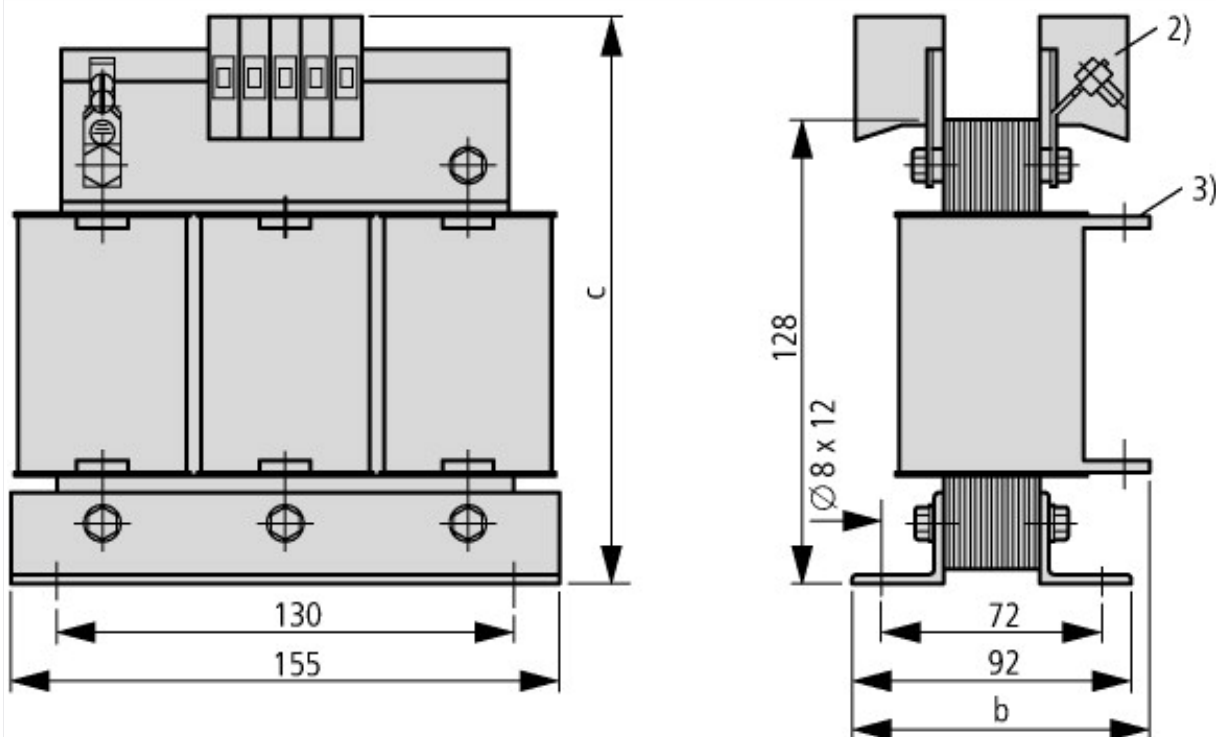

	b	c
18.5 V	92	154
24 V	92	154
42 V	92	154
110 V	92	154
230-690 V	92	154

- ① The higher rated operating voltage applies
- ② Terminals ≤ 25 A
- ③ Connection lugs > 63 A

Assets (links)

Declaration of CE Conformity

00003099