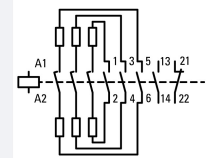

Contactor for capacitors, with series resistors, 12.5 kVAr, *V 50 Hz

Part no. DILK12-11(*V50HZ)
Catalog No. 293997
Alternate Catalog No. -

Delivery program

Product range			DILK Contactors for capacitors
Application			Contactors for power factor correction
Description			with series resistors
Rated power of AC-6b three-phase capacitors, 50 - 60 Hz			
Open			
230 V	Q	kVAr	7.5
400 V	Q	kVAr	12.5
525 V	Q	kVAr	16.7
690 V	Q	kVAr	20
Contact sequence			
Actuating voltage			*V 50 Hz
Note on equipment supplied			Minimum order quantity 10 items (packaging unit)
<p>Instructions In the case of group compensation multi-stage capacitor banks are connected to the mains, as required. Transient currents of up to $180 \times I_e$ could flow between the capacitors. The capacitors are pre-charged via the early-make auxiliary contacts and the fitted wire resistors, thereby reducing the inrush current. The main contacts then close in a time-delayed manner and bring about the continuous current. Due to their special contacts, the contactors for the capacitors are weld-resistant for capacitors with inrush current peaks and bring about the continuous current. Due to their special contacts, the contactors for capacitors are weld-resistant for capacitors with inrush current peaks up to $180 \times I_e$.</p>			

Technical data

General

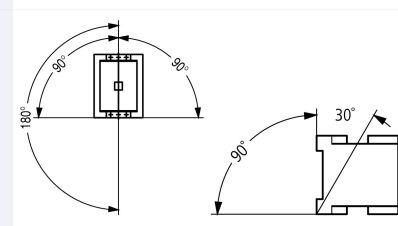
Standards			IEC/EN 60947
Ambient temperature			
Open		°C	-25 - +60
Enclosed		°C	- 25 - 40
Mounting position			
Degree of Protection			IP00
Protection against direct contact when actuated from front (EN 50274)			Finger and back-of-hand proof
Altitude		m	Max. 2000
Weight basic unit			
AC operated		kg	0.51
Terminal capacity main cable			
Solid		mm ²	1 x (0.75 - 16)
Flexible with ferrule		mm ²	1 x (0.75 - 16)
Stranded		mm ²	1 x 16
Solid or stranded		AWG	18 - 6
Flat conductor	Lamellenzahl x Breite x Dicke	mm	-

Rated power of AC-6b three-phase capacitors, 50 - 60 Hz

Open			
230 V	Q	kVAr	7.5
400 V	Q	kVAr	12.5
525 V	Q	kVAr	16.7
690 V	Q	kVAr	20
Rated operational current I_e of three-phase capacitors			
Open			
230 V	I_e	A	18
400 V	I_e	A	18
525 V	I_e	A	18
690 V	I_e	A	18
of three-phase capacitors enclosed			
230 V	I_e	A	16
400 V	I_e	A	16
525 V	I_e	A	16
690 V	I_e	A	16
Making capacity (i-peak value) without damping		$\times I_e$	180
Component lifespan		Operations $\times 10^6$	0.15
Maximum operating frequency		Ops./h	
Max. operating frequency		Ops/h	120

Magnet systems

Voltage tolerance			
AC operated	Pick-up	$\times U_c$	0.8 - 1.1
Drop-out voltage AC operated	Drop-out	$\times U_c$	0.3 - 0.6
Power consumption of the coil in a cold state and $1.0 \times U_S$			
50 Hz	Pick-up	VA	58
50 Hz	Sealing	VA	7.6
50 Hz	Sealing	W	2.1
60 Hz	Pick-up	VA	71
60 Hz	Sealing	VA	9.3
60 Hz	Sealing	W	2.1
Duty factor		% DF	100
Changeover time at 100 % U_S (recommended value)			
Main contacts			
AC operated			
Closing delay		ms	16 - 22
Opening delay		ms	8 - 14
Arcing time		ms	10

Electromagnetic compatibility (EMC)

Emitted interference			according to EN 60947-1
Interference immunity			according to EN 60947-1

Additional technical data

like the contactor	DIL		M17
--------------------	-----	--	-----

Rating data for approved types

Auxiliary contacts			
Pilot Duty			
AC operated			A600
DC operated			P300
General Use			
AC		V	600
AC		A	10
DC		V	250
DC		A	1
Special Purpose Ratings			
Capacitor Switching			

240V 60Hz 3phase	A	18
240V 60Hz 3phase	kVar	7.5
480V 60Hz 3phase	A	18
480V 60Hz 3phase	kVar	15
600V 60Hz 3phase	A	14.4
600V 60Hz 3phase	kVar	15

Design verification as per IEC/EN 61439

Technical data for design verification			
Rated operational current for specified heat dissipation	I_n	A	18
Heat dissipation per pole, current-dependent	P_{vid}	W	0.7
Equipment heat dissipation, current-dependent	P_{vid}	W	2.1
Static heat dissipation, non-current-dependent	P_{vs}	W	2.1
Heat dissipation capacity	P_{diss}	W	0
Operating ambient temperature min.		°C	-25
Operating ambient temperature max.		°C	60
IEC/EN 61439 design verification			
10.2 Strength of materials and parts			
10.2.2 Corrosion resistance			Meets the product standard's requirements.
10.2.3.1 Verification of thermal stability of enclosures			Meets the product standard's requirements.
10.2.3.2 Verification of resistance of insulating materials to normal heat			Meets the product standard's requirements.
10.2.3.3 Verification of resistance of insulating materials to abnormal heat and fire due to internal electric effects			Meets the product standard's requirements.
10.2.4 Resistance to ultra-violet (UV) radiation			Meets the product standard's requirements.
10.2.5 Lifting			Does not apply, since the entire switchgear needs to be evaluated.
10.2.6 Mechanical impact			Does not apply, since the entire switchgear needs to be evaluated.
10.2.7 Inscriptions			Meets the product standard's requirements.
10.3 Degree of protection of ASSEMBLIES			Does not apply, since the entire switchgear needs to be evaluated.
10.4 Clearances and creepage distances			Meets the product standard's requirements.
10.5 Protection against electric shock			Does not apply, since the entire switchgear needs to be evaluated.
10.6 Incorporation of switching devices and components			Does not apply, since the entire switchgear needs to be evaluated.
10.7 Internal electrical circuits and connections			Is the panel builder's responsibility.
10.8 Connections for external conductors			Is the panel builder's responsibility.
10.9 Insulation properties			
10.9.2 Power-frequency electric strength			Is the panel builder's responsibility.
10.9.3 Impulse withstand voltage			Is the panel builder's responsibility.
10.9.4 Testing of enclosures made of insulating material			Is the panel builder's responsibility.
10.10 Temperature rise			The panel builder is responsible for the temperature rise calculation. Eaton will provide heat dissipation data for the devices.
10.11 Short-circuit rating			Is the panel builder's responsibility. The specifications for the switchgear must be observed.
10.12 Electromagnetic compatibility			Is the panel builder's responsibility. The specifications for the switchgear must be observed.
10.13 Mechanical function			The device meets the requirements, provided the information in the instruction leaflet (IL) is observed.

Technical data ETIM 6.0

Low-voltage industrial components (EG000017) / Capacitor contactor (EC001079)			
Electric engineering, automation, process control engineering / Low-voltage switch technology / Contactor (LV) / Capacitor contactor (ecl@ss8.1-27-37-10-06 [AGZ569012])			
Rated control supply voltage U_s at AC 50HZ	V		24 - 600
Rated control supply voltage U_s at AC 60HZ	V		0 - 0
Rated control supply voltage U_s at DC	V		0 - 0
Voltage type for actuating			AC
Number of auxiliary contacts as normally open contact			1
Number of auxiliary contacts as normally closed contact			1
Type of electrical connection of main circuit			Screw connection
Number of main contacts as normally open contact			3

Number of normally closed contacts as main contact		0
Rated blind power at 400 V, 50 Hz	kvar	12.5

Approvals

Product Standards		IEC/EN 60947-4-1; UL 60947-4-1; CSA - C22.2 No. 60947-4-1-14; CE marking
UL File No.		E29096
UL Category Control No.		NLDX
CSA File No.		012528
CSA Class No.		3211-04
North America Certification		UL listed, CSA certified
Specially designed for North America		No

Dimensions

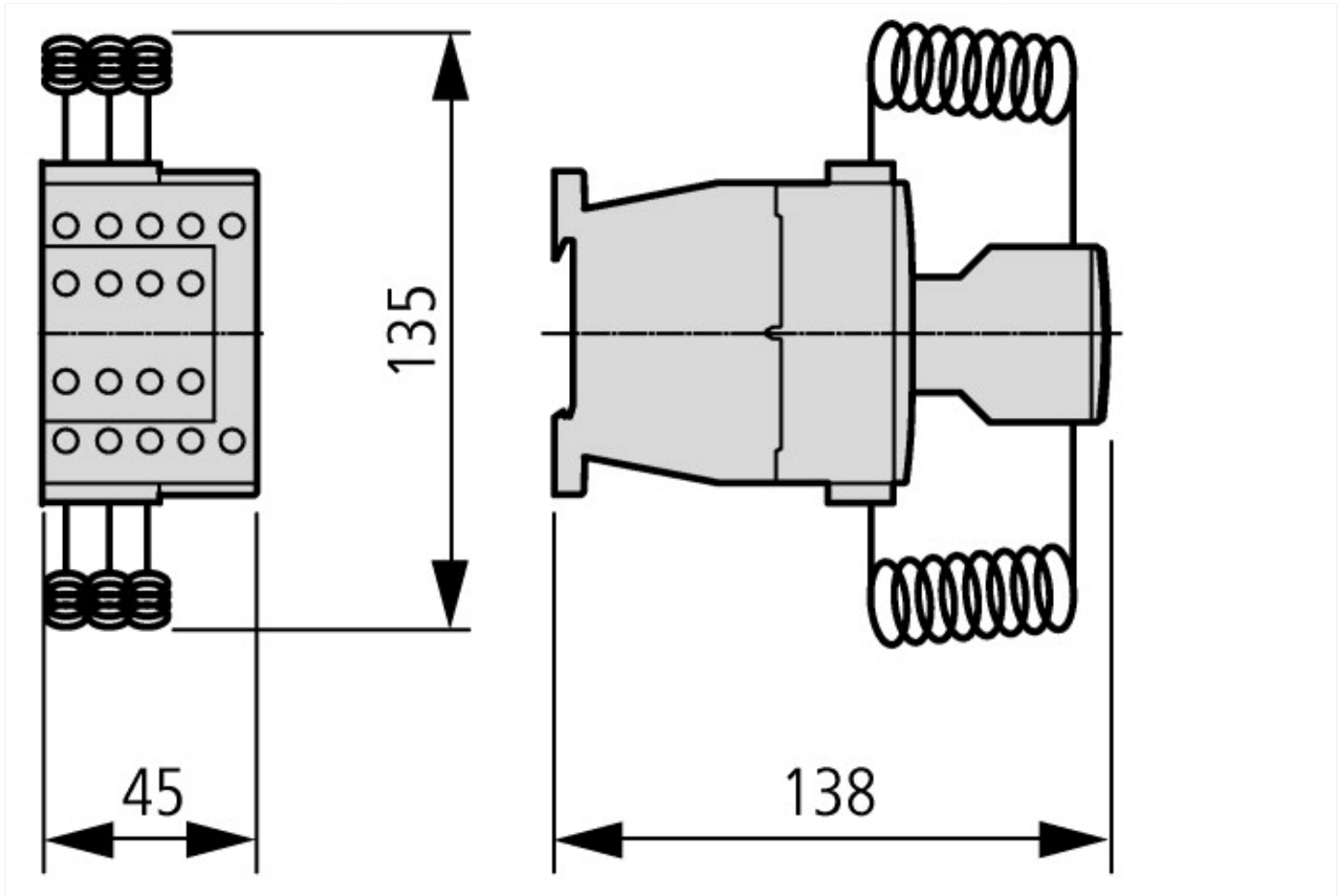

Contactors for capacitors with series resistors



Assets (links)

Instruction Leaflets

IL03407038Z2018_06

Additional product information (links)

IL03407038Z (AWA2100-2272) Contactor for capacitors

IL03407038Z (AWA2100-2272) Contactor for capacitors

ftp://ftp.moeller.net/DOCUMENTATION/AWA_INSTRUCTIONS/IL03407038Z2018_06.pdf