

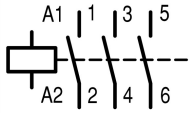

**Contactors, 3 pole, 380 V 400 V 30 kW, 380 V 50/60 Hz, AC operation, Screw terminals**

**Part no.** DILM65(380V50/60HZ)  
**Catalog No.** 277903  
**Alternate Catalog No.** XTCE065D00AR

**Delivery program**

|   |                |    |   |
|---|----------------|----|---|
| Product range   |                |    | Contactors  |
| Application   |                |    | Contactors for Motors   |
| Subrange  |                |    | Contactors up to 170 A, 3 pole  |
| Utilization category                                      |                |    | AC-1: Non-inductive or slightly inductive loads, resistance furnaces<br>AC-3/AC-3e: Normal AC induction motors: Starting, switching off while running<br>AC-4: Normal AC induction motors: starting, plugging, reversing, inching |
|   |                |    |   |
| Notes   |                |    | Also suitable for motors with efficiency class IE3.<br>IE3-ready devices are identified by the logo on their packaging.   |
| Connection technique                                      |                |    | Screw terminals   |
| Number of poles   |                |    | 3 pole  |
| <b>Rated operational current</b>                          |                |    |   |
| AC-3  |                |    |   |
| Notes   |                |    | At maximum permissible ambient temperature (open.)<br>Also tested according to AC-3e.   |
| 380 V 400 V   | $I_e$          | A  | 65  |
| AC-1  |                |    |   |
| Conventional free air thermal current, 3 pole, 50 - 60 Hz |                |    |   |
| Open  |                |    |   |
| at 40 °C  | $I_{th} = I_e$ | A  | 98  |
| enclosed  | $I_{th}$       | A  | 72  |
| Conventional free air thermal current, 1 pole             |                |    |   |
| open  | $I_{th}$       | A  | 200   |
| enclosed  | $I_{th}$       | A  | 180   |
| <b>Max. rating for three-phase motors, 50 - 60 Hz</b>     |                |    |   |
| AC-3  |                |    |   |
| 220 V 230 V   | P              | kW | 20  |
| 380 V 400 V   | P              | kW | 30  |
| 660 V 690 V   | P              | kW | 35  |
| AC-4  |                |    |   |
| 220 V 230 V   | P              | kW | 7   |
| 380 V 400 V   | P              | kW | 12  |
| 660 V 690 V   | P              | kW | 17  |
| Contact sequence  |                |    |   |
| <b>Instructions</b>                                       |                |    | Contacts to EN 50 012.  |
| Can be combined with auxiliary contact                    |                |    | DILM150-XHI(V)...<br>DILM1000-XHI(V)...   |
| Actuating voltage   |                |    | 380 V 50/60 Hz  |
| Voltage AC/DC   |                |    | AC operation  |
| Connection to SmartWire-DT                                |                |    | no  |
| Frame size  |                |    | 3   |

## Technical data

### General

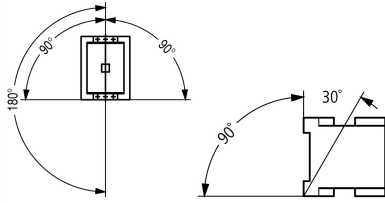
|   |                                     |                 |  |
|---|-------------------------------------|-----------------|--|
| Standards   |                                     |                 | IEC/EN 60947, VDE 0660, UL, CSA  |
| Lifespan, mechanical  |                                     |                 |  |
| AC operated   | Operations                          | $\times 10^6$   | 10   |
| Operating frequency, mechanical                                       |                                     |                 |  |
| AC operated   | Operations/h                        |                 | 5000   |
| Climatic proofing   |                                     |                 | Damp heat, constant, to IEC 60068-2-78<br>Damp heat, cyclic, to IEC 60068-2-30     |
| Ambient temperature   |                                     |                 |  |
| Open  |                                     | °C              | -25 - +60  |
| Enclosed  |                                     | °C              | -25 - 40   |
| Storage   |                                     | °C              | -40 - 80   |
| Mounting position   |                                     |                 |  |
| Mechanical shock resistance (IEC/EN 60068-2-27)                       |                                     |                 |  |
| Half-sinusoidal shock, 10 ms  |                                     |                 |  |
| Main contacts   |                                     |                 |  |
| N/O contact   |                                     | g               | 10   |
| Auxiliary contacts  |                                     |                 |  |
| N/O contact   |                                     | g               | 7  |
| N/C contact   |                                     | g               | 5  |
| Mechanical shock resistance (IEC/EN 60068-2-27) when tabletop-mounted |                                     |                 |  |
| Half-sinusoidal shock, 10 ms  |                                     |                 |  |
| Main contacts   |                                     |                 |  |
| N/O contact   |                                     | g               | 10   |
| Auxiliary contacts  |                                     |                 |  |
| N/O contact   |                                     | g               | 7  |
| N/C contact   |                                     | g               | 5  |
| Degree of Protection  |                                     |                 | IP00   |
| Protection against direct contact when actuated from front (EN 50274) |                                     |                 | Finger and back-of-hand proof  |
| Altitude  |                                     | m               | Max. 2000  |
| Weight  |                                     |                 |  |
| AC operated   |                                     | kg              | 0.87   |
| Screw connector terminals   |                                     |                 |  |
| Terminal capacity main cable  |                                     |                 |  |
| Solid   |                                     | mm <sup>2</sup> | 1 x (0.75 - 16)<br>2 x (0.75 - 16)   |
| Flexible with ferrule   |                                     | mm <sup>2</sup> | 1 x (0.75 - 35)<br>2 x (0.75 - 25)   |
| Stranded  |                                     | mm <sup>2</sup> | 1 x (16 - 50)<br>2 x (16 - 35)   |
| Solid or stranded   |                                     | AWG             | single 14 - 1, double 14 - 2   |
| Flat conductor  | Lamellenzahl<br>x Breite x<br>Dicke | mm              | 2 x (6 x 9 x 0.8)  |
| Stripping length  |                                     | mm              | 14   |
| Terminal screw  |                                     |                 | M6   |
| Tightening torque   |                                     | Nm              | 3.3  |
| Tool  |                                     |                 |  |
| Pozidriv screwdriver  |                                     | Size            | 2  |
| Standard screwdriver  |                                     | mm              | 0.8 x 5.5<br>1 x 6   |
| Terminal capacity control circuit cables                              |                                     |                 |  |

|                       |  |                 |                                      |
|-----------------------|--|-----------------|--------------------------------------|
| Solid                 |  | mm <sup>2</sup> | 1 x (0.75 - 4)<br>2 x (0.75 - 2.5)   |
| Flexible with ferrule |  | mm <sup>2</sup> | 1 x (0.75 - 2.5)<br>2 x (0.75 - 2.5) |
| Solid or stranded     |  | AWG             | 18 - 14                              |
| Stripping length      |  | mm              | 10                                   |
| Terminal screw        |  |                 | M3.5                                 |
| Tightening torque     |  | Nm              | 1.2                                  |
| Tool                  |  |                 |                                      |
| Pozidriv screwdriver  |  | Size            | 2                                    |
| Standard screwdriver  |  | mm              | 0.8 x 5.5<br>1 x 6                   |

### Main conducting paths

|  |             |      |       |
|--|-------------|------|-------|
| Rated impulse withstand voltage        | $U_{imp}$   | V AC | 8000  |
| Overvoltage category/pollution degree  |             |      | III/3 |
| Rated insulation voltage               | $U_i$       | V AC | 690   |
| Rated operational voltage              | $U_e$       | V AC | 690   |
| Safe isolation to EN 61140             |             |      |       |
| between coil and contacts              |             | V AC | 440   |
| between the contacts                   |             | V AC | 440   |
| Making capacity (p.f. to IEC/EN 60947) |             |      |       |
|  | Up to 690 V | A    | 910   |
| Breaking capacity                      |             |      |       |
| 220 V 230 V                            |             | A    | 650   |
| 380 V 400 V                            |             | A    | 650   |
| 500 V                                  |             | A    | 650   |
| 660 V 690 V                            |             | A    | 370   |
| Short-circuit rating                   |             |      |       |
| Short-circuit protection maximum fuse  |             |      |       |
| Type "2" coordination                  |             |      |       |
| 400 V                                  | gG/gL 500 V | A    | 125   |
| 690 V                                  | gG/gL 690 V | A    | 80    |
| Type "1" coordination                  |             |      |       |
| 400 V                                  | gG/gL 500 V | A    | 250   |
| 690 V                                  | gG/gL 690 V | A    | 100   |

### AC

|   |                |   |   |
|---|----------------|---|---|
| AC-1  |                |   |   |
| Rated operational current                                 |                |   |   |
| Conventional free air thermal current, 3 pole, 50 - 60 Hz |                |   |   |
| Open  |                |   |   |
| at 40 °C  | $I_{th} = I_e$ | A | 98  |
| at 50 °C  | $I_{th} = I_e$ | A | 88  |
| at 55 °C  | $I_{th} = I_e$ | A | 83  |
| at 60 °C  | $I_{th} = I_e$ | A | 80  |
| enclosed  | $I_{th}$       | A | 72  |
| Conventional free air thermal current, 1 pole             |                |   |   |
| open  | $I_{th}$       | A | 200   |
| enclosed  | $I_{th}$       | A | 180   |
| AC-3  |                |   |   |
| Rated operational current                                 |                |   |   |
| Open, 3-pole: 50 – 60 Hz                                  |                |   |   |
| Notes   |                |   | At maximum permissible ambient temperature (open.)<br>Also tested according to AC-3e. |
| 220 V 230 V   | $I_e$          | A | 65  |
| 240 V   | $I_e$          | A | 65  |
| 380 V 400 V   | $I_e$          | A | 65  |

|                          |       |     |     |
|--------------------------|-------|-----|-----|
| 415 V                    | $I_e$ | A   | 65  |
| 440V                     | $I_e$ | A   | 65  |
| 500 V                    | $I_e$ | A   | 65  |
| 660 V 690 V              | $I_e$ | A   | 37  |
| 380 V 400 V              | $I_e$ | A   | 65  |
| Motor rating             | P     | kWh |     |
| 220 V 230 V              | P     | kW  | 20  |
| 240V                     | P     | kW  | 22  |
| 380 V 400 V              | P     | kW  | 30  |
| 415 V                    | P     | kW  | 39  |
| 440 V                    | P     | kW  | 41  |
| 500 V                    | P     | kW  | 47  |
| 660 V 690 V              | P     | kW  | 35  |
| <b>AC-4</b>              |       |     |     |
| Open, 3-pole: 50 – 60 Hz |       |     |     |
| 220 V 230 V              | $I_e$ | A   | 25  |
| 240 V                    | $I_e$ | A   | 25  |
| 380 V 400 V              | $I_e$ | A   | 25  |
| 415 V                    | $I_e$ | A   | 25  |
| 440 V                    | $I_e$ | A   | 25  |
| 500 V                    | $I_e$ | A   | 25  |
| 660 V 690 V              | $I_e$ | A   | 20  |
| Motor rating             | P     | kWh |     |
| 220 V 230 V              | P     | kW  | 7   |
| 240 V                    | P     | kW  | 7.5 |
| 380 V 400 V              | P     | kW  | 12  |
| 415 V                    | P     | kW  | 13  |
| 440 V                    | P     | kW  | 14  |
| 500 V                    | P     | kW  | 16  |
| 660 V 690 V              | P     | kW  | 17  |

## DC

|                                 |       |   |    |
|---------------------------------|-------|---|----|
| Rated operational current, open |       |   |    |
| DC-1                            |       |   |    |
| 60 V                            | $I_e$ | A | 72 |
| 110 V                           | $I_e$ | A | 72 |
| 220 V                           | $I_e$ | A | 65 |

## Current heat loss

|  |  |    |      |
|--|--|----|------|
| 3 pole, at $I_{th}$ (60°)                |  | W  | 25.9 |
| Current heat loss at $I_e$ to AC-3/400 V |  | W  | 17.1 |
| Impedance per pole                       |  | mΩ | 1.9  |

## Magnet systems

|  |          |         |            |
|--|----------|---------|------------|
| Voltage tolerance  |          |         |            |
| AC operated  | Pick-up  | $x U_c$ | 0.8 - 1.1  |
| Drop-out voltage AC operated                                       | Drop-out | $x U_c$ | 0.3 - 0.6  |
| Power consumption of the coil in a cold state and $1.0 \times U_S$ |          |         |            |
| 50/60 Hz   | Pick-up  | VA      | 168<br>154 |
| 50/60 Hz   | Sealing  | VA      | 22<br>14   |
| 50/60 Hz   | Sealing  | W       | 4.1        |
| Duty factor  |          | % DF    | 100        |
| Changeover time at 100 % $U_S$ (recommended value)                 |          |         |            |
| Main contacts  |          |         |            |
| AC operated  |          |         |            |
| Closing delay  |          | ms      | 12 - 18    |

|  |                   |  |
|--|-------------------|--|
| Opening delay                              | ms                | 8 - 13   |
| Arcing time                                | ms                | 10   |
| Lifespan, mechanical; Coil 50/60 Hz        | x 10 <sup>6</sup> | Mechanical lifespan at 50 Hz approx. 30% lower than under → Technical data general |
| <b>Electromagnetic compatibility (EMC)</b> |                   |  |
| Emitted interference                       |                   | to EN 60947-1  |
| Interference immunity                      |                   | to EN 60947-1  |

## Design verification as per IEC/EN 61439

|  |                   |    |  |
|--|-------------------|----|--|
| Technical data for design verification   |                   |    |  |
| Rated operational current for specified heat dissipation   | I <sub>n</sub>    | A  | 65   |
| Heat dissipation per pole, current-dependent   | P <sub>vid</sub>  | W  | 5.7  |
| Equipment heat dissipation, current-dependent  | P <sub>vid</sub>  | W  | 17.1   |
| Static heat dissipation, non-current-dependent   | P <sub>vs</sub>   | W  | 4.1  |
| Heat dissipation capacity  | P <sub>diss</sub> | W  | 0  |
| Operating ambient temperature min.   |                   | °C | -25  |
| Operating ambient temperature max.   |                   | °C | 60   |
| IEC/EN 61439 design verification   |                   |    |  |
| 10.2 Strength of materials and parts   |                   |    |  |
| 10.2.2 Corrosion resistance  |                   |    | Meets the product standard's requirements.   |
| 10.2.3.1 Verification of thermal stability of enclosures   |                   |    | Meets the product standard's requirements.   |
| 10.2.3.2 Verification of resistance of insulating materials to normal heat   |                   |    | Meets the product standard's requirements.   |
| 10.2.3.3 Verification of resistance of insulating materials to abnormal heat and fire due to internal electric effects |                   |    | Meets the product standard's requirements.   |
| 10.2.4 Resistance to ultra-violet (UV) radiation   |                   |    | Meets the product standard's requirements.   |
| 10.2.5 Lifting   |                   |    | Does not apply, since the entire switchgear needs to be evaluated.   |
| 10.2.6 Mechanical impact   |                   |    | Does not apply, since the entire switchgear needs to be evaluated.   |
| 10.2.7 Inscriptions  |                   |    | Meets the product standard's requirements.   |
| 10.3 Degree of protection of ASSEMBLIES  |                   |    | Does not apply, since the entire switchgear needs to be evaluated.   |
| 10.4 Clearances and creepage distances   |                   |    | Meets the product standard's requirements.   |
| 10.5 Protection against electric shock   |                   |    | Does not apply, since the entire switchgear needs to be evaluated.   |
| 10.6 Incorporation of switching devices and components   |                   |    | Does not apply, since the entire switchgear needs to be evaluated.   |
| 10.7 Internal electrical circuits and connections  |                   |    | Is the panel builder's responsibility.   |
| 10.8 Connections for external conductors   |                   |    | Is the panel builder's responsibility.   |
| 10.9 Insulation properties   |                   |    |  |
| 10.9.2 Power-frequency electric strength   |                   |    | Is the panel builder's responsibility.   |
| 10.9.3 Impulse withstand voltage   |                   |    | Is the panel builder's responsibility.   |
| 10.9.4 Testing of enclosures made of insulating material   |                   |    | Is the panel builder's responsibility.   |
| 10.10 Temperature rise   |                   |    | The panel builder is responsible for the temperature rise calculation. Eaton will provide heat dissipation data for the devices. |
| 10.11 Short-circuit rating   |                   |    | Is the panel builder's responsibility. The specifications for the switchgear must be observed.                                   |
| 10.12 Electromagnetic compatibility  |                   |    | Is the panel builder's responsibility. The specifications for the switchgear must be observed.                                   |
| 10.13 Mechanical function  |                   |    | The device meets the requirements, provided the information in the instruction leaflet (IL) is observed.                         |

## Technical data ETIM 7.0

|   |    |           |
|---|----|-----------|
| Low-voltage industrial components (EG000017) / Power contactor, AC switching (EC000066)   |    |           |
| Electric engineering, automation, process control engineering / Low-voltage switch technology / Contactor (LV) / Power contactor, AC switching (ecl@ss10.0.1-27-37-10-03 [AAB718015]) |    |           |
| Rated control supply voltage U <sub>s</sub> at AC 50HZ  | V  | 380 - 380 |
| Rated control supply voltage U <sub>s</sub> at AC 60HZ  | V  | 380 - 380 |
| Rated control supply voltage U <sub>s</sub> at DC   | V  | 0 - 0     |
| Voltage type for actuating  |    | AC        |
| Rated operation current I <sub>e</sub> at AC-1, 400 V   | A  | 98        |
| Rated operation current I <sub>e</sub> at AC-3, 400 V   | A  | 65        |
| Rated operation power at AC-3, 400 V  | kW | 30        |

|   |    |                  |
|---|----|------------------|
| Rated operation current $I_e$ at AC-4, 400 V            | A  | 25               |
| Rated operation power at AC-4, 400 V                    | kW | 12               |
| Rated operation power NEMA                              | kW | 37               |
| Modular version   |    | No               |
| Number of auxiliary contacts as normally open contact   |    | 0                |
| Number of auxiliary contacts as normally closed contact |    | 0                |
| Type of electrical connection of main circuit           |    | Screw connection |
| Number of normally closed contacts as main contact      |    | 0                |
| Number of main contacts as normally open contact        |    | 3                |

## Characteristics

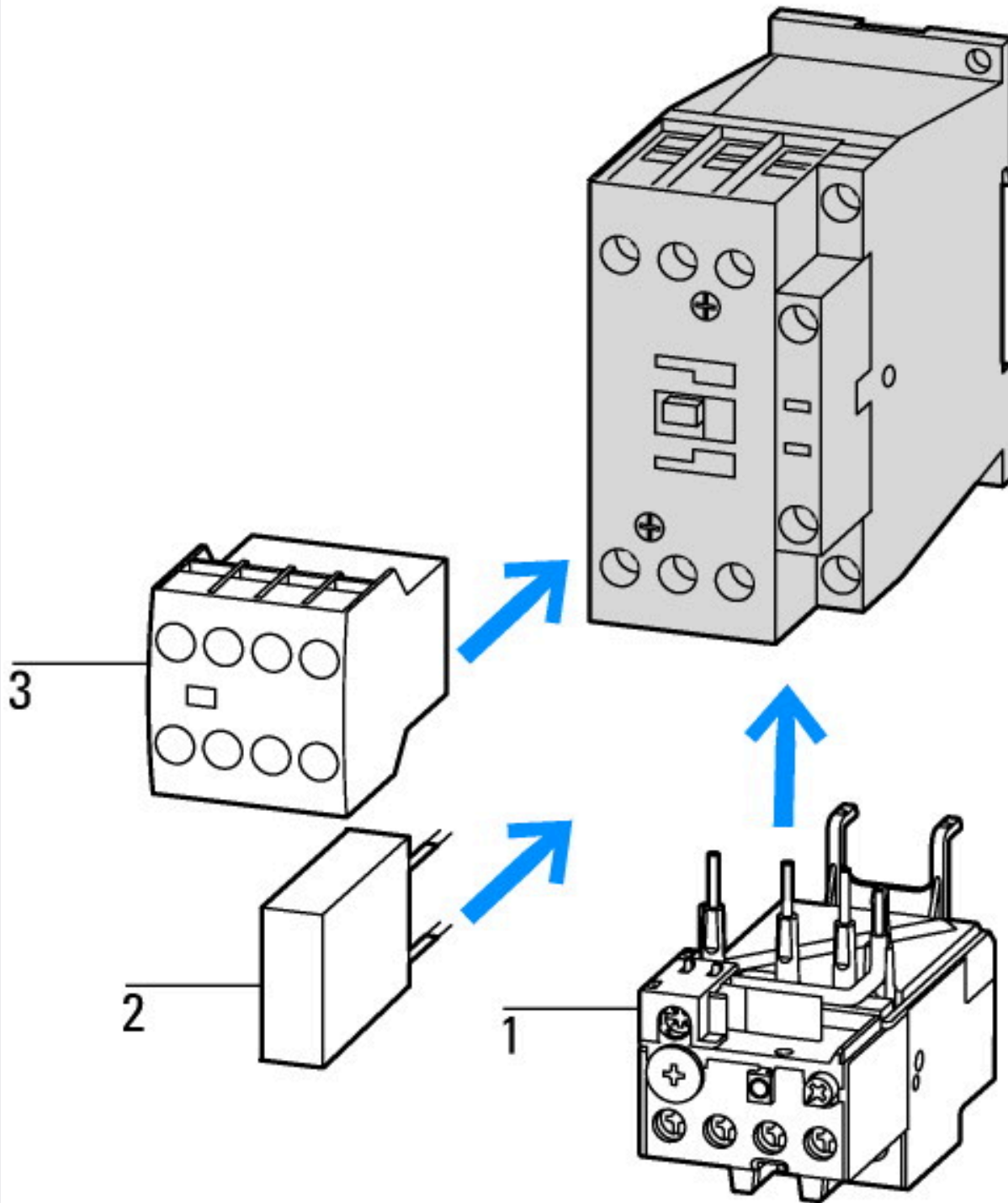

- 1: Overload relay
- 2: Suppressor
- 3: Auxiliary contact modules

# DILM1000-XHI(V)11-...

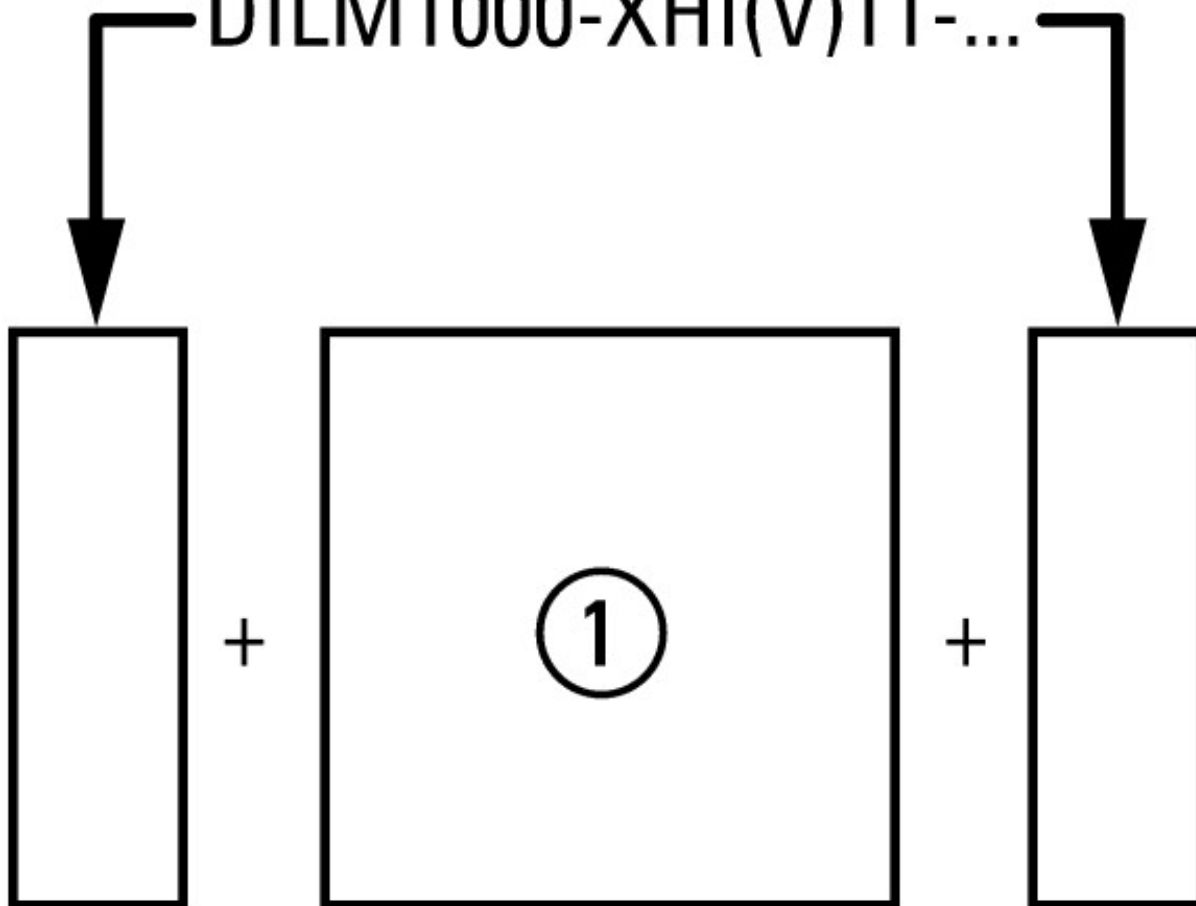

on the side: 2 x DILM1000-XHI(V)11-SI; surface mounting: 1 x DILM150-XHIA11  
 on the side: 2 x DILM1000-XHI(V)11-SA; surface mounting: 1 x DILM150-XHI (2 pole)  
 on the side: 1 x DILM1000-XHI(V)11-SI; surface mounting: 1 x DILM150-XHIA22  
 on the side: 1 x DILM1000-XHI(V)11-SA; surface mounting: 1 x DILM150-XHI (4 pole)

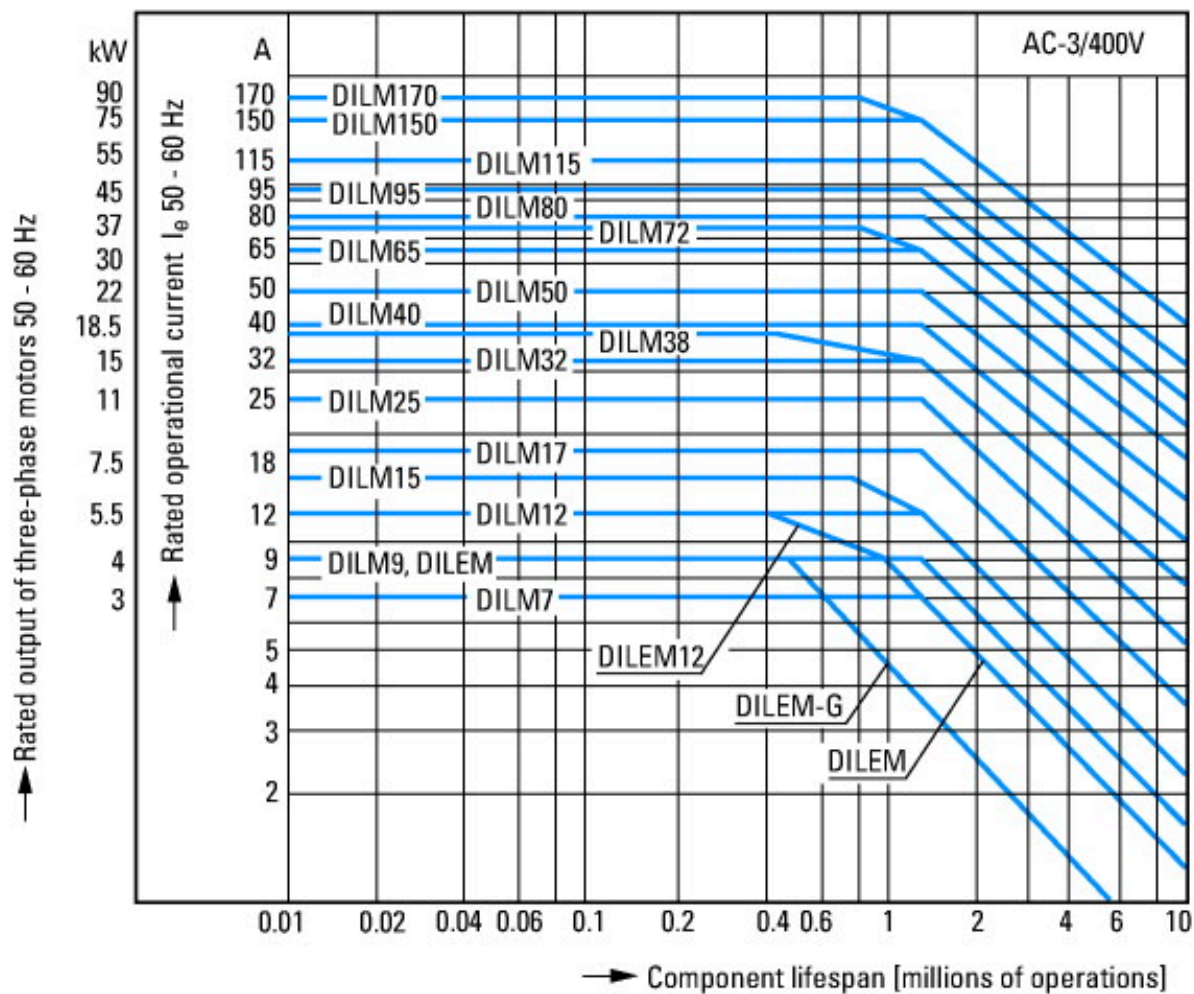

Squirrel-cage motor  
 Operating characteristics  
 Starting: from rest  
 Stopping: after attaining full running speed  
 Electrical characteristics  
 Make: up to 6 x rated motor current  
 Break: up to 1 x rated motor current  
 Utilization category  
 100 % AC-3  
 Typical applications  
 Compressors  
 Lifts  
 Mixers  
 Pumps  
 Escalators  
 Agitators  
 Fans  
 Conveyor belts  
 Centrifuges  
 Hinged flaps  
 Bucket-elevators  
 Air conditioning system  
 General drives in manufacturing and processing machines



Extreme switching duty  
 Squirrel-cage motor  
 Operating characteristics  
 Inching, plugging, reversing  
 Electrical characteristics  
 Make: up to 6 x rated motor current  
 Break: up to 6 x rated motor current  
 Utilization category  
 100 % AC-4  
 Typical applications  
 Printing presses  
 Wire-drawing machines  
 Centrifuges  
 Special drives for manufacturing and processing machines





Switching conditions for non-motor consumers, 3 pole, 4 pole  
 Operating characteristics  
 Non inductive and slightly inductive loads  
 Electrical characteristics  
 Switch on: 1 x rated operational current  
 Switch off: 1 x rated operational current  
 Utilization category  
 100 % AC-1  
 Typical examples of application  
 Electric heat

## Dimensions

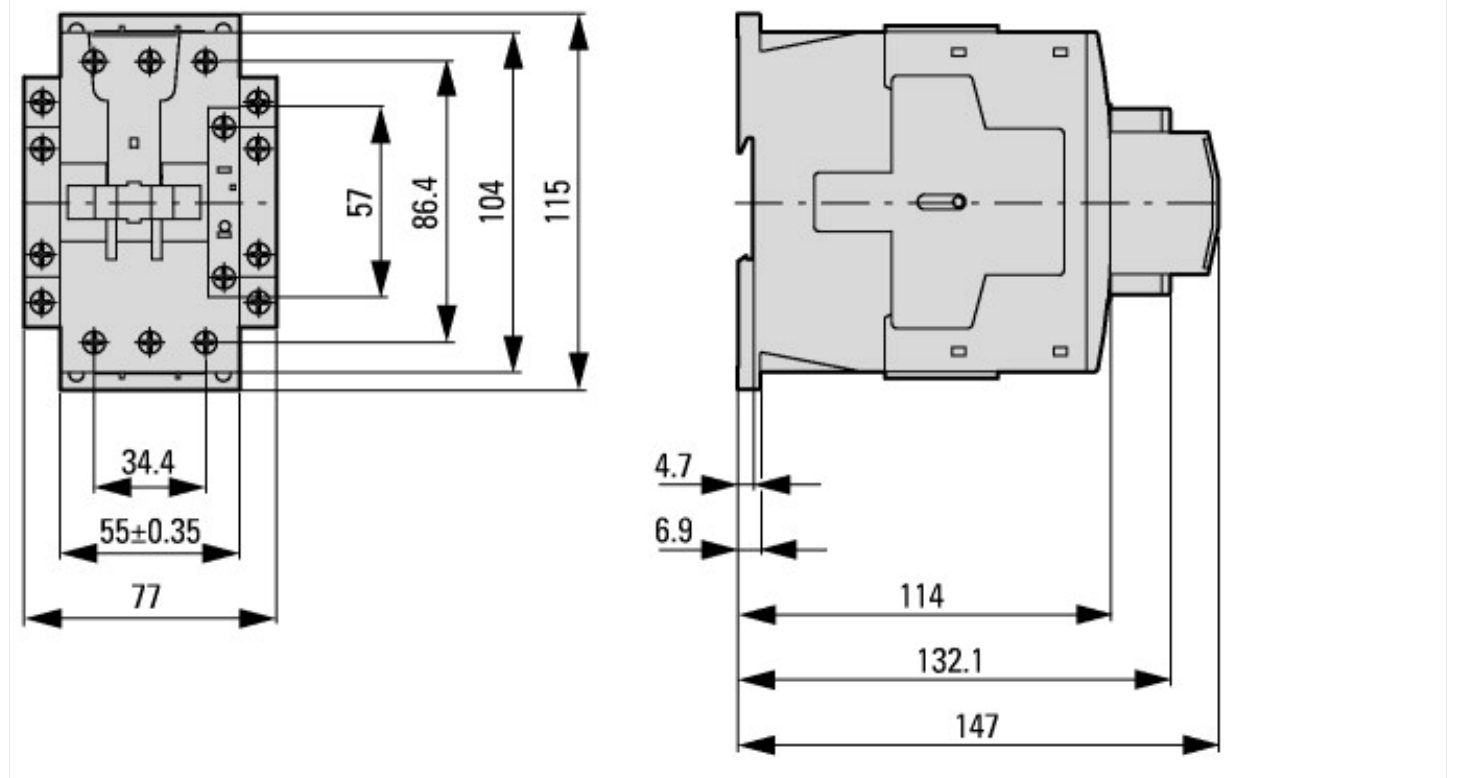

Contacteur avec module de contact auxiliaire



Lateral clearance to earthed parts: 6 mm

DILM40...DILM72  
 DILMC40...DILMC65  
 DILMF40...DILMF65

## Additional product information (links)

### IL03407033Z (AWA2100-2247) DILM contactor, basic device

|  |   |
|--|---|
| IL03407033Z (AWA2100-2247) DILM contactor, basic device                                      | <a href="https://es-assets.eaton.com/DOCUMENTATION/AWA_INSTRUCTIONS/IL03407033Z2018_03.pdf">https://es-assets.eaton.com/DOCUMENTATION/AWA_INSTRUCTIONS/IL03407033Z2018_03.pdf</a>                               |
| Motor starters and "Special Purpose Ratings" for the North American market                   | <a href="http://www.eaton.eu/ecm/groups/public/@pub/@europe/@electrical/documents/content/pct_3258146.pdf">http://www.eaton.eu/ecm/groups/public/@pub/@europe/@electrical/documents/content/pct_3258146.pdf</a> |
| Switchgear of Power Factor Correction Systems  | <a href="http://www.moeller.net/binary/ver_techpapers/ver934en.pdf">http://www.moeller.net/binary/ver_techpapers/ver934en.pdf</a>   |
| X-Start - Modern Switching Installations Efficiently Fitted and Wired Securely               | <a href="http://www.moeller.net/binary/ver_techpapers/ver938en.pdf">http://www.moeller.net/binary/ver_techpapers/ver938en.pdf</a>   |
| Mirror Contacts for Highly-Reliable Information Relating to Safety-Related Control Functions | <a href="http://www.moeller.net/binary/ver_techpapers/ver944en.pdf">http://www.moeller.net/binary/ver_techpapers/ver944en.pdf</a>   |

|  |   |
|--|---|
| Effect of the Cable Capacitance of Long Control Cables on the Actuation of Contactors          | <a href="http://www.moeller.net/binary/ver_techpapers/ver949en.pdf">http://www.moeller.net/binary/ver_techpapers/ver949en.pdf</a> |
| Switchgear for Luminaires  | <a href="http://www.moeller.net/binary/ver_techpapers/ver955en.pdf">http://www.moeller.net/binary/ver_techpapers/ver955en.pdf</a> |
| Standard Compliant and Functionally Safe Engineering Design with Mechanical Auxiliary Contacts | <a href="http://www.moeller.net/binary/ver_techpapers/ver956en.pdf">http://www.moeller.net/binary/ver_techpapers/ver956en.pdf</a> |
| The Interaction of Contactors with PLCs  | <a href="http://www.moeller.net/binary/ver_techpapers/ver957en.pdf">http://www.moeller.net/binary/ver_techpapers/ver957en.pdf</a> |
| Busbar Component Adapters for modern Industrial control panels                                 | <a href="http://www.moeller.net/binary/ver_techpapers/ver960en.pdf">http://www.moeller.net/binary/ver_techpapers/ver960en.pdf</a> |