

Switch-disconnector, DMV, 630 A, 3P + N (solid), Stop Function optional, Without rotary handle and drive shaft



Part no. DMV-630N/1
Catalog No. 1814443

Delivery program

Product range			Switch-disconnector Main switch maintenance switch
Part group reference			DMV
Stop Function			optional
			Without rotary handle and drive shaft
Notes			visible contacts
Information about equipment supplied			auxiliary contact fitted by user. including connection materials
Number of poles			3P + N (solid)
Auxiliary contacts			
		N/O	0
		N/C	0
Degree of Protection			IP00 IP20 with terminal cover
Design			surface mounting
Contact sequence			
Motor rating AC-23A, 50 - 60 Hz			
400 V	P	kW	375
Rated uninterrupted current	I _u	A	630
Note on rated uninterrupted current I _u			Rated uninterrupted current I _u is specified for max. cross-section.

Technical data

General			
Standards			IEC/EN 60947, VDE 0660, IEC/EN 60204 Switch-disconnector according to IEC/EN 60947-3
Certifications			CE, RoHs, KEMA, EAC, Lloyds
Ambient temperature			
Operation	θ	°C	-25 - +55
Storage	θ	°C	-30 - +80
Overvoltage category/pollution degree			III/3
Rated impulse withstand voltage	U _{imp}	kV	12
Rated insulation voltage	U _i	V	1000
Mounting position			As required
Contacts			
Mechanical variables			

Number of poles			3P + N (solid)
Auxiliary contacts			
		N/O	0
		N/C	0
Electrical characteristics			
Rated operational voltage	U_e	V AC	690
Rated uninterrupted current	I_u	A	630
Note on rated uninterrupted current I_u			Rated uninterrupted current I_u is specified for max. cross-section.
Short-circuit rating			
fuse			1000/630
Rated conditional short-circuit current	I_q	kA	$I_n = 1000: 50$ $I_n = 630: 100$
Breaking current		kA	$I_n = 1000: 70$ $I_n = 630: 65$
max. let-through energy		kA^2s	$I_n = 1000: 4200$ $I_n = 630: 3200$
Rated short-time withstand current (1 s current)	I_{cw}	A_{rms}	36000
Note on rated short-time withstand current I_{cw}			Current for a time of 0.3 seconds
Heat dissipation per pole, current-dependent	P_{vid}	W	17.5

Switching capacity

Rated breaking capacity $\cos \phi$ to IEC 60947-3		A	
400/415 V		A	5040
500 V		A	4600
690 V		A	3496
Safe isolation to EN 61140			
Current heat loss per contact at I_e		W	17.5
Lifespan, mechanical	Operations		5000
AC			
AC-21A			
Rated operational current switch			
400 V 415 V	I_e	A	630
500 V	I_e	A	630
690 V	I_e	A	630
AC-22A			
Rated operational current switch			
400 V 415 V	I_e	A	630
500 V	I_e	A	630
690 V	I_e	A	630
AC-23A			
Rated operational current switch			
400 V 415 V	I_e	A	630
500 V	I_e	A	575
690 V	I_e	A	437
Motor rating AC-23A, 50 - 60 Hz			
400 V 415 V	P	kW	375
500 V	P	kW	425
690 V	P	kW	425

Terminal capacities

Flat conductor connection with busbars		mm^2	400
Terminal screw			M10 x 30
Tightening torque for terminal screw		Nm	28

Technical safety parameters:

Notes			B10 _q values as per EN ISO 13849-1, table C1
--------------	--	--	---

Design verification as per IEC/EN 61439

Technical data for design verification			
--	--	--	--

Rated operational current for specified heat dissipation	I_n	A	630
Heat dissipation per pole, current-dependent	P_{vid}	W	17.5
Equipment heat dissipation, current-dependent	P_{vid}	W	0
Static heat dissipation, non-current-dependent	P_{vs}	W	0
Heat dissipation capacity	P_{diss}	W	0
Operating ambient temperature min.		°C	-25
Operating ambient temperature max.		°C	55
IEC/EN 61439 design verification			
10.2 Strength of materials and parts			
10.2.2 Corrosion resistance			Meets the product standard's requirements.
10.2.3.1 Verification of thermal stability of enclosures			Meets the product standard's requirements.
10.2.3.2 Verification of resistance of insulating materials to normal heat			Meets the product standard's requirements.
10.2.3.3 Verification of resistance of insulating materials to abnormal heat and fire due to internal electric effects			Meets the product standard's requirements.
10.2.4 Resistance to ultra-violet (UV) radiation			Meets the product standard's requirements.
10.2.5 Lifting			Does not apply, since the entire switchgear needs to be evaluated.
10.2.6 Mechanical impact			Does not apply, since the entire switchgear needs to be evaluated.
10.2.7 Inscriptions			Meets the product standard's requirements.
10.3 Degree of protection of ASSEMBLIES			Does not apply, since the entire switchgear needs to be evaluated.
10.4 Clearances and creepage distances			Meets the product standard's requirements.
10.5 Protection against electric shock			Does not apply, since the entire switchgear needs to be evaluated.
10.6 Incorporation of switching devices and components			Does not apply, since the entire switchgear needs to be evaluated.
10.7 Internal electrical circuits and connections			Is the panel builder's responsibility.
10.8 Connections for external conductors			Is the panel builder's responsibility.
10.9 Insulation properties			
10.9.2 Power-frequency electric strength			Is the panel builder's responsibility.
10.9.3 Impulse withstand voltage			Is the panel builder's responsibility.
10.9.4 Testing of enclosures made of insulating material			Is the panel builder's responsibility.
10.10 Temperature rise			The panel builder is responsible for the temperature rise calculation. Eaton will provide heat dissipation data for the devices.
10.11 Short-circuit rating			Is the panel builder's responsibility. The specifications for the switchgear must be observed.
10.12 Electromagnetic compatibility			Is the panel builder's responsibility. The specifications for the switchgear must be observed.
10.13 Mechanical function			The device meets the requirements, provided the information in the instruction leaflet (IL) is observed.

Technical data ETIM 7.0

Low-voltage industrial components (EG000017) / Switch disconnecter (EC000216)			
Electric engineering, automation, process control engineering / Low-voltage switch technology / Off-load switch, circuit breaker, control switch / Switch disconnecter (ec1@ss10.0.1-27-37-14-03 [AKF060013])			
Version as main switch			Yes
Version as maintenance-/service switch			Yes
Version as safety switch			No
Version as emergency stop installation			Yes
Version as reversing switch			No
Number of switches			1
Max. rated operation voltage U_e AC		V	690
Rated operating voltage		V	690 - 690
Rated permanent current I_u		A	630
Rated permanent current at AC-23, 400 V		A	630
Rated permanent current at AC-21, 400 V		A	630
Rated operation power at AC-3, 400 V		kW	0
Rated short-time withstand current I_{cw}		kA	36
Rated operation power at AC-23, 400 V		kW	375
Switching power at 400 V		kW	375
Conditioned rated short-circuit current I_q		kA	100

Number of poles	3
Number of auxiliary contacts as normally closed contact	0
Number of auxiliary contacts as normally open contact	0
Number of auxiliary contacts as change-over contact	0
Motor drive optional	No
Motor drive integrated	No
Voltage release optional	No
Device construction	Complete device in housing
Suitable for ground mounting	Yes
Suitable for front mounting 4-hole	No
Suitable for front mounting centre	No
Suitable for distribution board installation	No
Suitable for intermediate mounting	No
Colour control element	Other
Type of control element	Other
Interlockable	No
Type of electrical connection of main circuit	Screw connection
Degree of protection (IP), front side	IP20
Degree of protection (NEMA)	Other

Dimensions

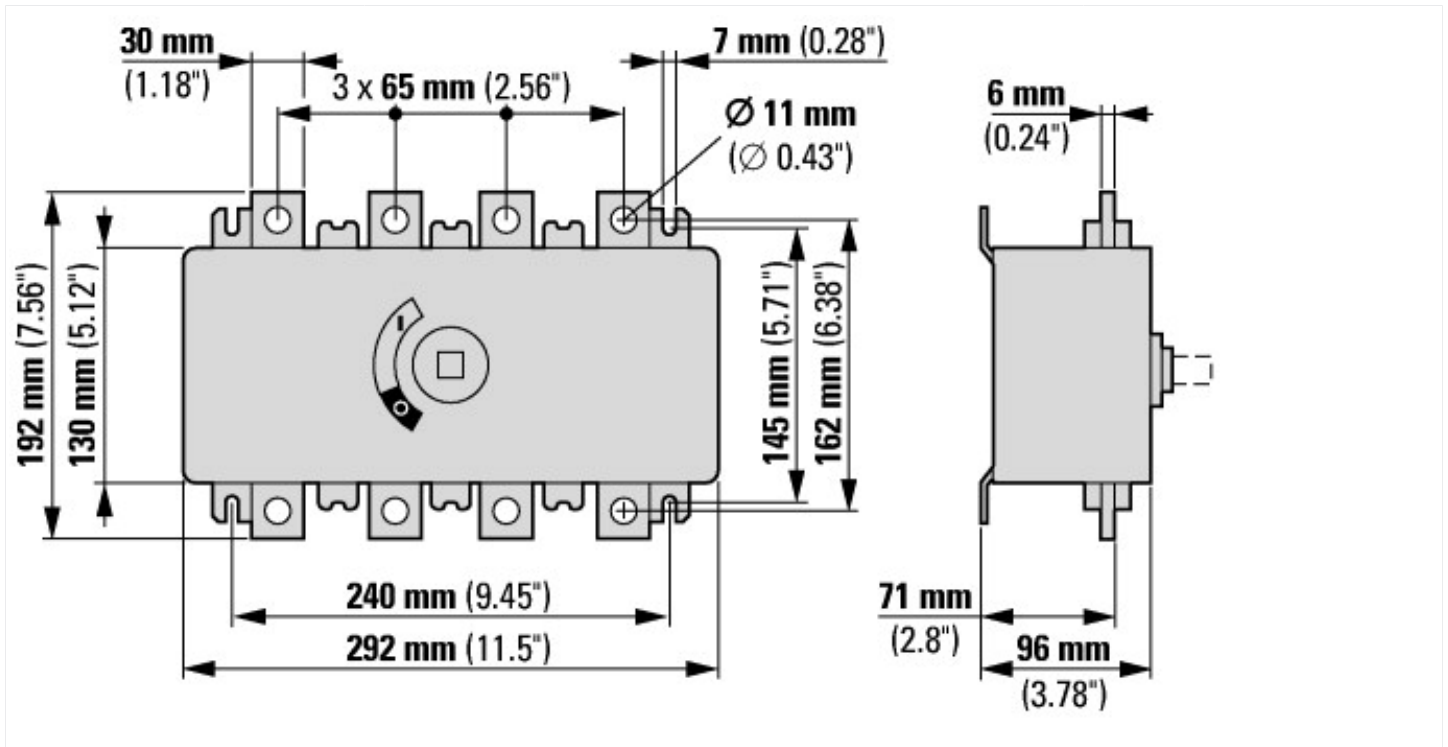

Additional product information (links)

IL008008Z Switch-disconnectors

IL008008Z Switch-disconnectors

ftp://ftp.moeller.net/DOCUMENTATION/AWA_INSTRUCTIONS/IL008008ZU2018_05.pdf