

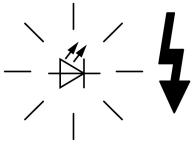

Strobe light module; blue; LED;120 V

Part no. SL4-FL120-B
Catalog No. 171361
Alternate Catalog No. SL4-FL120-B
EL-Nummer (Norway) 4137596

Delivery program

Product range			SL signal towers
Basic function			Strobe light module
Degree of Protection			IP66
Rated operational voltage	U_e	V	110/120 V AC
Type of light			Strobe light
Light elements			LED
Colour			Blue
			
Function			
Connection to SmartWire-DT			no

Technical data

General

Standards			IEC/EN 60947-5-1
Climatic proofing			Damp heat, cyclic, to IEC 60068-2-30
Mounting position			As required
Mechanical shock resistance		g	> 15 according to IEC 60068-2-27 Shock duration 11 ms Sinusoidal
IEC degree of protection			IP66 IEC/EN 60529
Protection type UL			Type 4, 4X, 13
Material			Enclosure: Polycarbonate (PC), black Cap: Polycarbonate (PC)
Cap colour			Blue
Ambient temperature		°C	-30 - +60
Number of signal elements			Max. 5 with standard base Max. 10 with base for mounting on both sides
Weight		g	45

Contacts

Rated impulse withstand voltage	U_{imp}	V AC	4000
Rated insulation voltage	U_i	V	250
Overvoltage category/pollution degree			III/3

modules

Type of light			Strobe light
Light elements			LED
Flashing/strobe frequency			1.4 Hz

Leakage current	A	< 0.003
lifespan	h	> 100000
Transmission angle		360°
Current-/power consumption		
at 110 /120 V AC	A	0.10
Voltage range		110/120 V AC ± 10 %

Design verification as per IEC/EN 61439

Technical data for design verification		
Operating ambient temperature min.	°C	-30
Operating ambient temperature max.	°C	60

Technical data ETIM 7.0

Low-voltage industrial components (EG000017) / Optical module for signal tower (EC000232)		
Electric engineering, automation, process control engineering / Low-voltage switch technology / Command and alarm device / Optical module for signal tower (ecl@ss10.0.1-27-37-12-20 [AKF038014])		
Function		Flash light
Colour		Blue
Outer diameter	mm	43
Operating voltage at AC 50 Hz	V	110 - 120
Operating voltage at AC 60 Hz	V	110 - 120
Operating voltage at DC	V	0 - 0
Voltage type		AC
Lamp type		LED
Colour housing		Black
Degree of protection (IP)		IP66
Degree of protection (NEMA)		4X

Approvals

Product Standards		IEC/EN 60947-5-1; UL 508; CSA-C22.2 No. 14-10; CSA-C22.2 No. 94-91; CE marking
UL File No.		E29184
UL Category Control No.		NKCR
CSA File No.		UL report applies to both US and Canada
CSA Class No.		NKCR7
North America Certification		UL listed, certified by UL for use in Canada
Degree of Protection		UL Type 4, 4X, 13

Dimensions

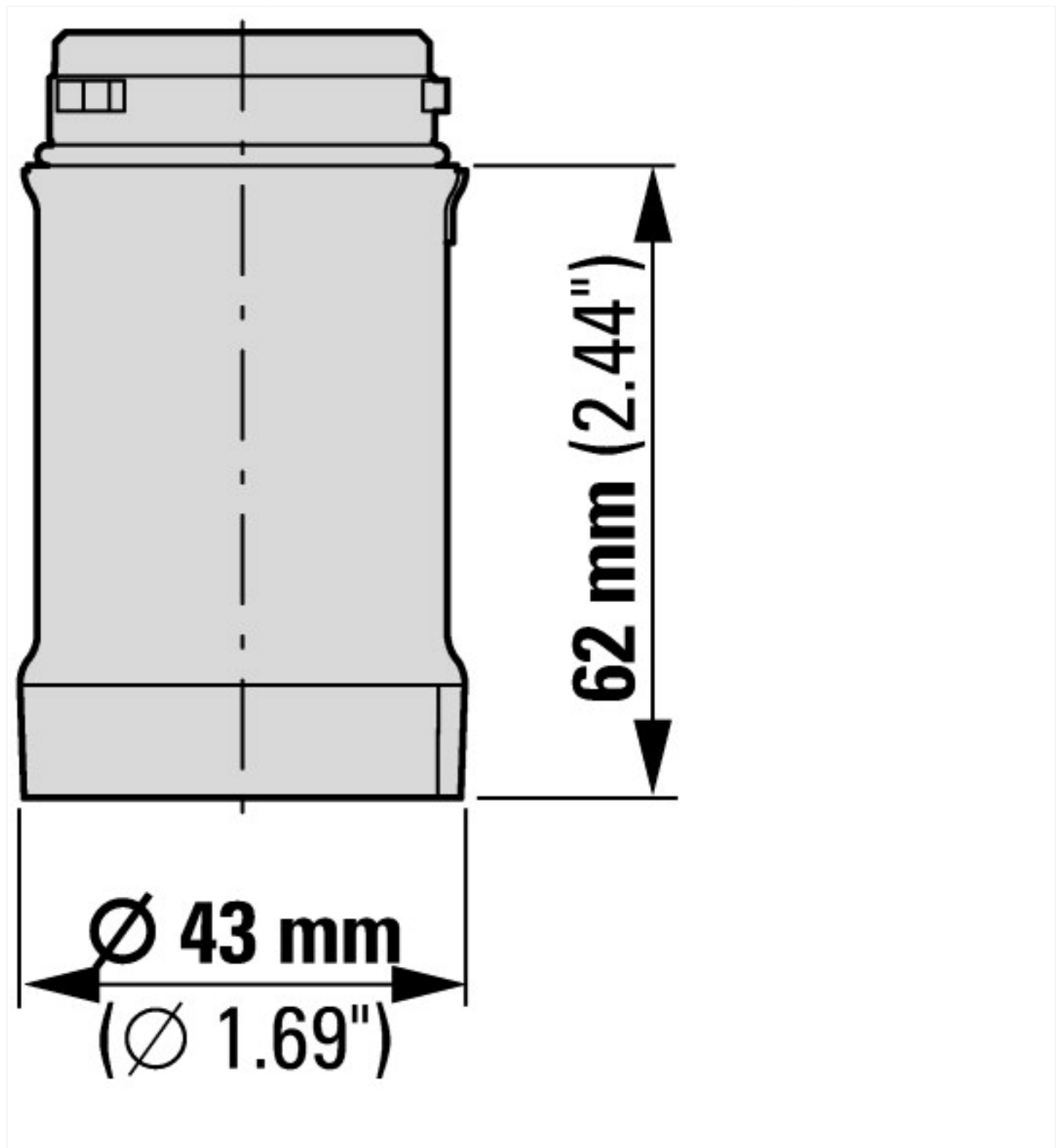

Assets (links)

Declaration of CE Conformity

00002899

Instruction Leaflets

IL047001ZU2018_05

Additional product information (links)

IL047001ZU SL4 Main Instruction

IL047001ZU SL4 Main Instruction

ftp://ftp.moeller.net/DOCUMENTATION/AWA_INSTRUCTIONS/IL047001ZU2018_05.pdf