

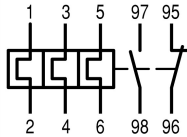

**Overload relay, Separate mounting, Earth-fault protection: with, I<sub>r</sub>= 4 - 20 A, 1 N/O, 1 N/C**

**Part no.** ZEB32-20-GF/KK  
**Catalog No.** 136500  
**Alternate Catalog No.** XTOE020CGSS  
**EL-Nummer (Norway)** 0004137369

**Delivery program**

Product range			Electronic overload relays ZEB
Phase-failure sensitivity			IEC/EN 60947, VDE 0660 Part 102
Description			Test/off button Reset pushbutton Manual/auto reset selectable Protection in the case of starting under load (class 10 to class 20)
Mounting type			Separate mounting
<b>Earth-fault protection</b>			
Earth-fault protection			with
Trip at approx.			> 0.5 x I <sub>r</sub> in 2 s > 1.5 x I <sub>r</sub> in 1 s
<b>Setting range</b>			
Overload releases	I <sub>r</sub>	A	4 - 20
			
Contact sequence			
<b>Auxiliary contacts</b>			
N/O = Normally open			1 N/O
N/C = Normally closed			1 N/C
For use with			DILM17 DILM25 DILM32 DILM38 DIULM17 DIULM25 DIULM32 DIULM32 SDAINLM30 SDAINLM45 SDAINLM55

**Technical data**

<b>General</b>			
Standards			IEC/EN 60947, VDE 0660, UL, CSA
Climatic proofing			Damp heat, constant, to IEC 60068-2-78 Damp heat, cyclic, to IEC 60068-2-30
Ambient temperature			
Open		°C	-25 - +65
Ambient temperature open max.		°C	65
Enclosed		°C	
Ambient temperature enclosed max.		°C	65
Mechanical shock resistance		g	15 Shock duration 10 ms according to IEC 60068-2-27
Degree of Protection			IP20
Protection against direct contact when actuated from front (EN 50274)			Finger and back-of-hand proof
Altitude		m	Max. 2000
<b>Main conducting paths</b>			
Rated impulse withstand voltage	U <sub>imp</sub>	V AC	6000

Overvoltage category/pollution degree			III/3
Rated insulation voltage	$U_i$	V AC	690
Rated operational voltage	$U_e$	V AC	690
Rated frequency	f	Hz	50/60
Safe isolation to EN 61140			
Between auxiliary contacts and main contacts		V AC	600
Between main circuits		V AC	600
Terminal capacities		mm <sup>2</sup>	
Solid		mm <sup>2</sup>	1 x 1.5 - 16
Solid or stranded		AWG	1 x 14 - 4
Stripping length		mm	13

### Auxiliary and control circuits

Rated impulse withstand voltage	$U_{imp}$	V	6000
Overvoltage category/pollution degree			III/3
Terminal capacities		mm <sup>2</sup>	
Solid		mm <sup>2</sup>	2 x (0.75 - 4)
Flexible with ferrule		mm <sup>2</sup>	2 x (0.75 - 2.5)
Solid or stranded		AWG	2 x (18 - 12)
Terminal screw			M3.5
Tightening torque		Nm	0.8 - 1.2
Tightening torque		lb-in	7
Stripping length		mm	8
Tools			
Pozidriv screwdriver		Size	2
Standard screwdriver		mm	1 x 6
Rated insulation voltage	$U_i$	V AC	500
Rated operational voltage	$U_e$	V AC	500
Safe isolation to EN 61140			
between the auxiliary contacts		V AC	240
Conventional thermal current	$I_{th}$	A	5
Rated operational current	$I_e$	A	
AC-15			
Make contact			
120 V	$I_e$	A	1.5
220 V 230 V 240 V	$I_e$	A	1.5
380 V 400 V 415 V	$I_e$	A	0.5
500 V	$I_e$	A	0.5
Break contact			
120 V	$I_e$	A	1.5
220 V 230 V 240 V	$I_e$	A	1.5
380 V 400 V 415 V	$I_e$	A	0.9
500 V	$I_e$	A	0.8
DC L/R ≤ 15 ms			
			Switch-on and switch-off conditions based on DC-13, time constant as specified.
24 V	$I_e$	A	0.9
60 V	$I_e$	A	0.75
110 V	$I_e$	A	0.4
220 V	$I_e$	A	0.2
Short-circuit rating without welding			
max. fuse		A gG/gL	6

### Rating data for approved types

Auxiliary contacts			
Pilot Duty			

AC operated			B600
DC operated			R300
Short Circuit Current Rating		SCCR	
600 V High Fault			
SCCR (fuse)		kA	100
max. Fuse		A	60 Class J

## Design verification as per IEC/EN 61439

Technical data for design verification			
Rated operational current for specified heat dissipation	$I_n$	A	20
Heat dissipation per pole, current-dependent	$P_{vid}$	W	0.77
Equipment heat dissipation, current-dependent	$P_{vid}$	W	2.3
Static heat dissipation, non-current-dependent	$P_{vs}$	W	0
Heat dissipation capacity	$P_{diss}$	W	0
Operating ambient temperature min.		°C	-25
Operating ambient temperature max.		°C	65
IEC/EN 61439 design verification			
10.2 Strength of materials and parts			
10.2.2 Corrosion resistance			Meets the product standard's requirements.
10.2.3.1 Verification of thermal stability of enclosures			Meets the product standard's requirements.
10.2.3.2 Verification of resistance of insulating materials to normal heat			Meets the product standard's requirements.
10.2.3.3 Verification of resistance of insulating materials to abnormal heat and fire due to internal electric effects			Meets the product standard's requirements.
10.2.4 Resistance to ultra-violet (UV) radiation			Meets the product standard's requirements.
10.2.5 Lifting			Does not apply, since the entire switchgear needs to be evaluated.
10.2.6 Mechanical impact			Does not apply, since the entire switchgear needs to be evaluated.
10.2.7 Inscriptions			Meets the product standard's requirements.
10.3 Degree of protection of ASSEMBLIES			Does not apply, since the entire switchgear needs to be evaluated.
10.4 Clearances and creepage distances			Meets the product standard's requirements.
10.5 Protection against electric shock			Does not apply, since the entire switchgear needs to be evaluated.
10.6 Incorporation of switching devices and components			Does not apply, since the entire switchgear needs to be evaluated.
10.7 Internal electrical circuits and connections			Is the panel builder's responsibility.
10.8 Connections for external conductors			Is the panel builder's responsibility.
10.9 Insulation properties			
10.9.2 Power-frequency electric strength			Is the panel builder's responsibility.
10.9.3 Impulse withstand voltage			Is the panel builder's responsibility.
10.9.4 Testing of enclosures made of insulating material			Is the panel builder's responsibility.
10.10 Temperature rise			The panel builder is responsible for the temperature rise calculation. Eaton will provide heat dissipation data for the devices.
10.11 Short-circuit rating			Is the panel builder's responsibility. The specifications for the switchgear must be observed.
10.12 Electromagnetic compatibility			Is the panel builder's responsibility. The specifications for the switchgear must be observed.
10.13 Mechanical function			The device meets the requirements, provided the information in the instruction leaflet (IL) is observed.

## Technical data ETIM 7.0

Low-voltage industrial components (EG000017) / Electronic overload relay (EC001080)			
Electric engineering, automation, process control engineering / Low-voltage switch technology / Overload protection device / Electronic overload relay (ecl@ss10.0.1-27-37-15-02 [AKF076014])			
Adjustable current range		A	4 - 20
Mounting method			Separate positioning
Type of electrical connection of main circuit			Screw connection
Number of auxiliary contacts as normally closed contact			1
Number of auxiliary contacts as normally open contact			1
Number of auxiliary contacts as change-over contact			0
Rated control supply voltage $U_s$ at AC 50HZ		V	0 - 0
Rated control supply voltage $U_s$ at AC 60HZ		V	0 - 0

Rated control supply voltage $U_s$ at DC	V	0 - 0
Release class		Adjustable
Voltage type for actuating		Self powered
Reset function automatic		Yes
Reset function input		No
Reset function push-button		Yes

## Approvals

Product Standards		UL 508; CSA-C22.2 No. 14; IEC/EN 60947-4-1; CE marking
UL File No.		E1230
UL Category Control No.		NKCR
CSA File No.		2290956
CSA Class No.		3211-03
North America Certification		UL listed, CSA certified
Specially designed for North America		No
Suitable for		Branch circuits
Max. Voltage Rating		600 V AC
Degree of Protection		IEC: IP20, UL/CSA Type: -

## Characteristics

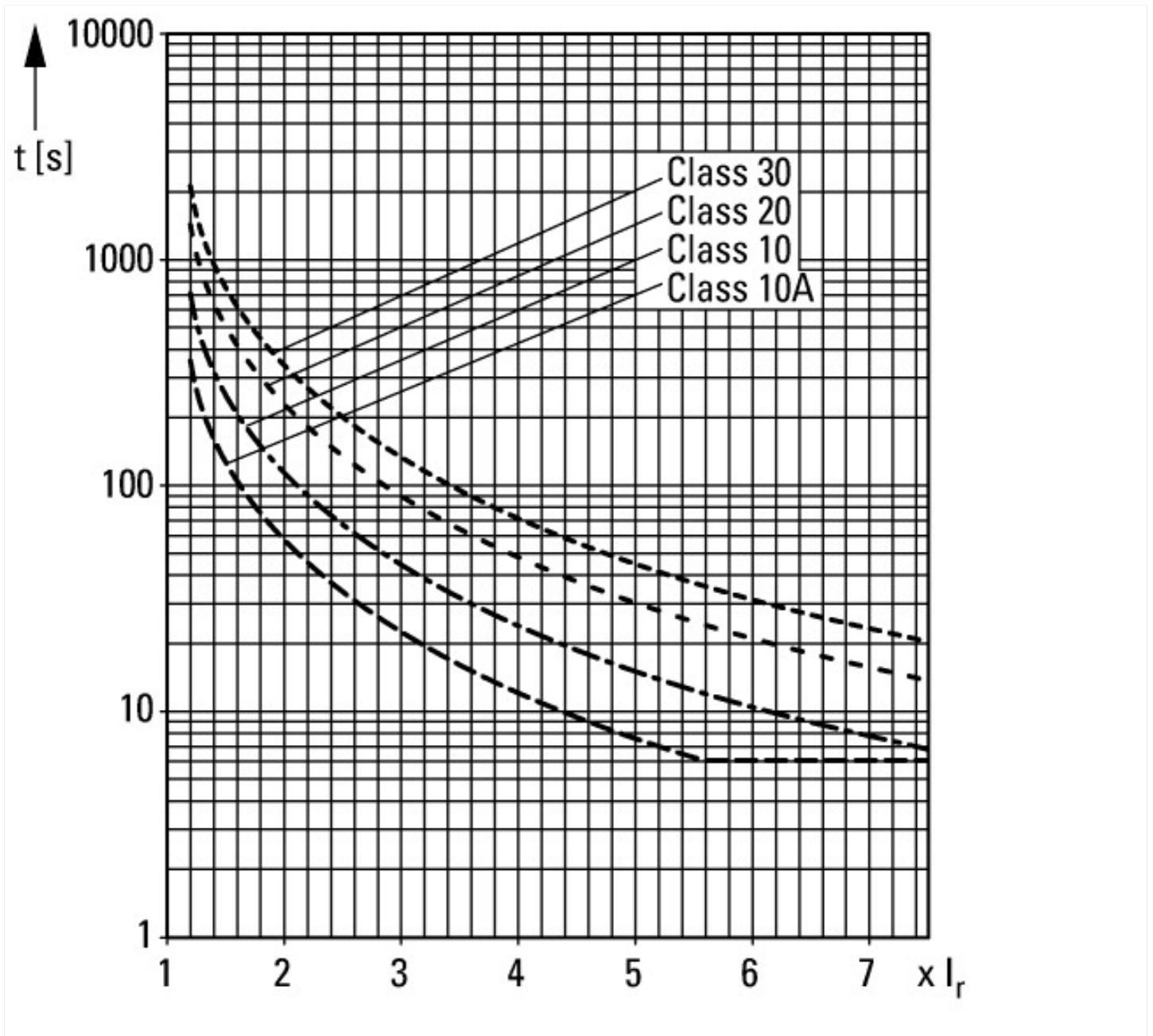

## Dimensions

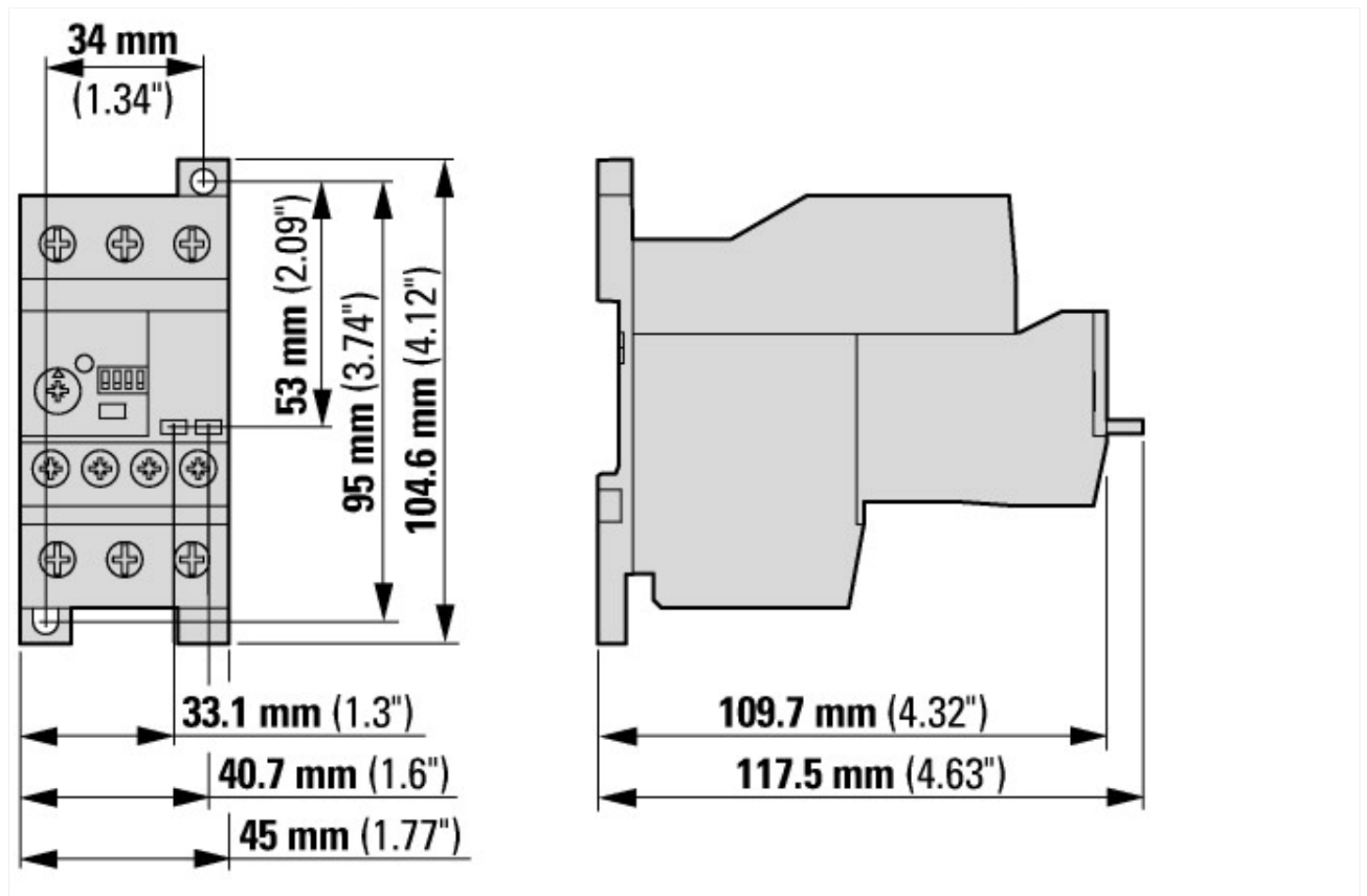

## Assets (links)

### Declaration of CE Conformity

00003052

### Instruction Leaflets

IL04210002E2018\_08

## Additional product information (links)

IL04210002E Solid-state motor protection relay

IL04210002E Solid-state motor protection relay [ftp://ftp.moeller.net/DOCUMENTATION/AWA\\_INSTRUCTIONS/IL04210002E2018\\_08.pdf](ftp://ftp.moeller.net/DOCUMENTATION/AWA_INSTRUCTIONS/IL04210002E2018_08.pdf)