



Key-operated actuator, 3 positions, blue, momentary

Part no. Q18S3-BL
Catalog No. 046368
Alternate Catalog No. Q18S3-BL

Delivery program

Product range			RMQ16
Basic function			Key-operated buttons
Single unit/Complete unit			Single unit
Design			Key operated momentary
Function:			
			45° 45°
			3 positions
Key withdrawable in position			
			0
Degree of Protection			IP65
Front ring			without bezel
Connection to SmartWire-DT			no
Front dimensions			Front dimensions 18 x 18 mm
Information about equipment supplied			With 1 key
Ordering information			For each color there is a corresponding key, → accessories,

Notes

Additional individual lock mechanisms (each colour corresponds with

Technical data

General

Standards			IEC/EN 60947
Lifespan, mechanical	Operations	x 10 ⁶	> 3
Operating frequency	Operations/h		≤ 1800
Operating torque		Nm	≤ 0.4
Degree of protection, IEC/EN 60529			IP65
Climatic proofing			Damp heat, constant, to IEC 60068-2-78 Damp heat, cyclic, to IEC 60068-2-30
Ambient temperature			
Open		°C	-25 - +60
Enclosed		°C	- 25 - 40
Mounting position			As required
Mechanical shock resistance		g	> 40 according to IEC 60068-2-27 Shock duration 11 ms Sinusoidal
Terminal capacities		mm ²	0.5 - 1.0
Blade terminal			2.8 x 0.8 mm to DIN 46244
Fast-on connectors			2.8 x 0.8 mm to DIN 46247 and IEC 60760

Contacts

Rated impulse withstand voltage	U _{imp}	V AC	800
Rated insulation voltage	U _i	V	250
Overvoltage category/pollution degree			III/3
Rated operational voltage	U _e	V AC	24
Control circuit reliability			
at 24 V DC/5 mA	H _F	Fault probability	< 10 ⁻⁷ , < 1 failure in 10 ⁷ operations

at 5 V DC/1 mA	H _F	Fault probability	< 5 x 10 ⁻⁶ , < 1 failure in 5 x 10 ⁶ operations
Use of insulated ferrule ISH 2,8			On >24 V AC/DC recommended On >50 V AC or 120 V DC mandatory, also on unoccupied blade terminals

Design verification as per IEC/EN 61439

Technical data for design verification			
Rated operational current for specified heat dissipation	I _n	A	0
Heat dissipation per pole, current-dependent	P _{vid}	W	0
Equipment heat dissipation, current-dependent	P _{vid}	W	0
Static heat dissipation, non-current-dependent	P _{vs}	W	0
Heat dissipation capacity	P _{diss}	W	0
Operating ambient temperature min.		°C	-25
Operating ambient temperature max.		°C	60
IEC/EN 61439 design verification			
10.2 Strength of materials and parts			
10.2.2 Corrosion resistance			
			Meets the product standard's requirements.
10.2.3.1 Verification of thermal stability of enclosures			
			Meets the product standard's requirements.
10.2.3.2 Verification of resistance of insulating materials to normal heat			
			Meets the product standard's requirements.
10.2.3.3 Verification of resistance of insulating materials to abnormal heat and fire due to internal electric effects			
			Meets the product standard's requirements.
10.2.4 Resistance to ultra-violet (UV) radiation			
			Please enquire
10.2.5 Lifting			
			Does not apply, since the entire switchgear needs to be evaluated.
10.2.6 Mechanical impact			
			Does not apply, since the entire switchgear needs to be evaluated.
10.2.7 Inscriptions			
			Meets the product standard's requirements.
10.3 Degree of protection of ASSEMBLIES			
			Does not apply, since the entire switchgear needs to be evaluated.
10.4 Clearances and creepage distances			
			Meets the product standard's requirements.
10.5 Protection against electric shock			
			Does not apply, since the entire switchgear needs to be evaluated.
10.6 Incorporation of switching devices and components			
			Does not apply, since the entire switchgear needs to be evaluated.
10.7 Internal electrical circuits and connections			
			Is the panel builder's responsibility.
10.8 Connections for external conductors			
			Is the panel builder's responsibility.
10.9 Insulation properties			
10.9.2 Power-frequency electric strength			
			Is the panel builder's responsibility.
10.9.3 Impulse withstand voltage			
			Is the panel builder's responsibility.
10.9.4 Testing of enclosures made of insulating material			
			Is the panel builder's responsibility.
10.10 Temperature rise			
			Not applicable.
10.11 Short-circuit rating			
			Is the panel builder's responsibility. The specifications for the switchgear must be observed.
10.12 Electromagnetic compatibility			
			Is the panel builder's responsibility. The specifications for the switchgear must be observed.
10.13 Mechanical function			
			The device meets the requirements, provided the information in the instruction leaflet (IL) is observed.

Technical data ETIM 7.0

Low-voltage industrial components (EG000017) / Front element for selector switch (EC000222)			
Electric engineering, automation, process control engineering / Low-voltage switch technology / Command and alarm device / Front element for selector switches (ec!@ss10.0.1-27-37-12-13 [AKF031014])			
Number of switch positions			3
Type of control element			Key
Suitable for illumination			No
Colour control element			Blue
Colour indicator light cap			Other
Construction type lens			Square
Hole diameter		mm	16
Width opening		mm	0
Height opening		mm	0
Switching function latching			No
Spring-return			Yes

With front ring		Yes
Material front ring		Plastic
Colour front ring		Black
Degree of protection (IP), front side		IP65
Degree of protection (NEMA)		1

Approvals

Product Standards		IEC/EN 60947-5; UL 508; CSA-C22.2 No. 14-05; CE marking
UL File No.		E29184
UL Category Control No.		NKCR
CSA File No.		46552
CSA Class No.		3211-03
North America Certification		UL listed, CSA certified
Degree of Protection		UL/CSA Type 1

Dimensions

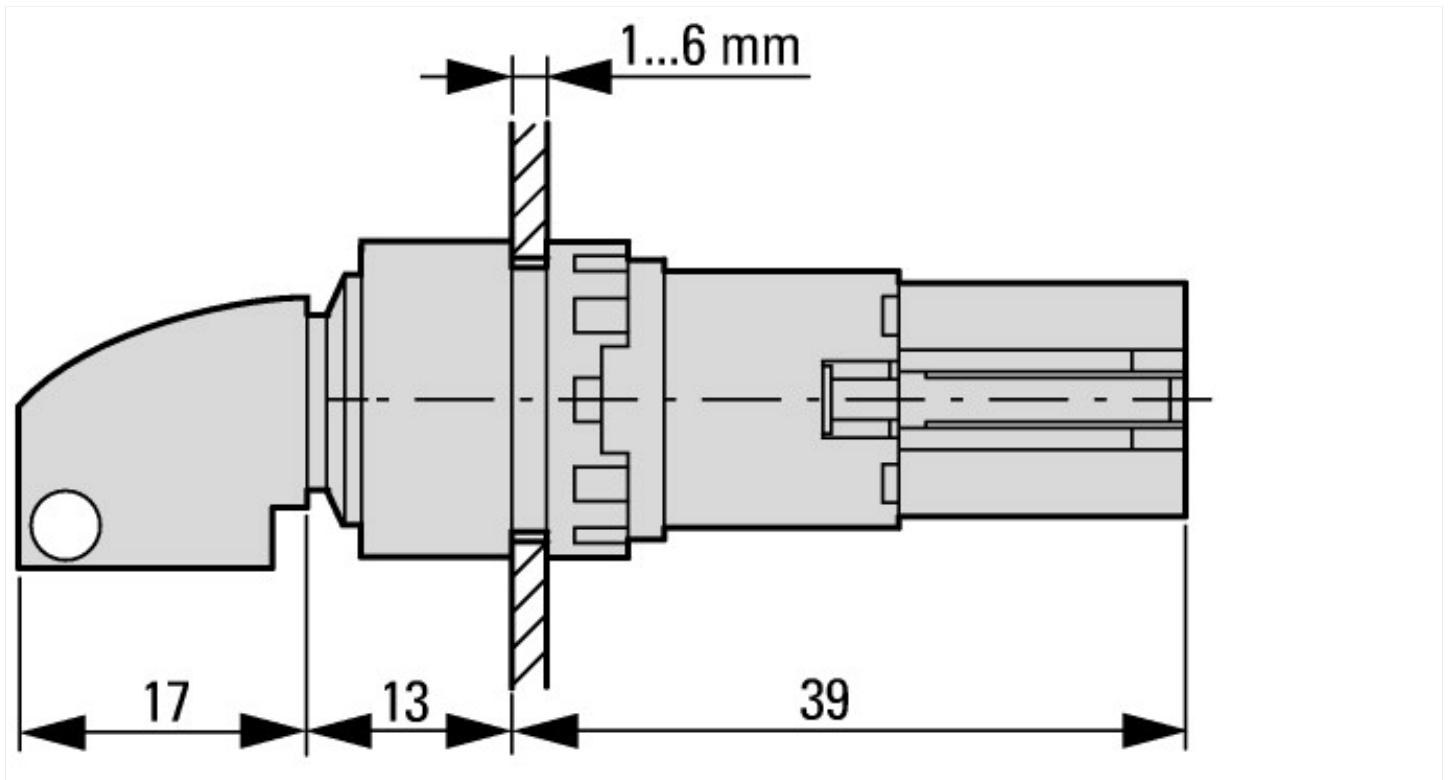

Actuating and indicator elements
Square style

Assets (links)

Declaration of CE Conformity

00002898

Instruction Leaflets

IL04716016Z2018_05

Additional product information (links)

IL04716016Z (AWA1160-1429) Mounting of components

IL04716016Z (AWA1160-1429) Mounting of components

ftp://ftp.moeller.net/DOCUMENTATION/AWA_INSTRUCTIONS/IL04716016Z2018_05.pdf