

Type: **NZMN3-AE630-S1**  
 Article No.: **290369**  
 Sales text **Circuit-breaker 3p 630A 1000V**



### Ordering information

Number of poles			3-pole
Description			Terminal screws standard, terminals as accessories
Rated current = rated uninterrupted current	$I_u$	A	630
Setting range			
Overload releases	$I_r$	A	315...630
Switching capacity			
Frame size			NZM3

### Notes concerning the product group

IEC/EN 60947-2

Adjustable overload release  $I_r$

- NZMH2-A...-S1:  $0.8 \dots 1 \times I_n$  (ex-works  $0.8 \times I_n$ )
- NZMN3-AE...-S1:  $0.5 \dots 1 \times I_n$  (ex-works  $0.5 \times I_n$ )
- NZMH4-AE...-S1:  $0.5 \dots 1 \times I_n$  (ex-works  $0.5 \times I_n$ )

Adjustable short-circuit release  $I_i$

- NZMH2-A40-S1:  $8 \dots 10 \times I_n$  (ex-works  $8 \times I_n$ )
- NZMH2-A50...250-S1:  $6 \dots 10 \times I_n$  (ex-works  $6 \times I_n$ )
- NZMN3-AE250/400-S1:  $2 \dots 11 \times I_n$  (ex-works  $6 \times I_n$ )

- NZMN3–AE630–S1: 2 ... 8 ×  $I_n$  (ex–works 6 ×  $I_n$ )
- NZMH4–AE...–S1: 2 ... 12 ×  $I_n$  (ex–works 6 ×  $I_n$ )

Fixed short–circuit release  $I_f$

- 350 A at  $I_n = 20 ... 32$  A

Connection types

NZM2: Cover NZM2–XKSA necessary

NZM2: Cover NZM2–XKSA necessary

NZM4: insulated busbar connection (screw terminal NZM4–XKS)

## Notes concerning the product group

Accessories → plug–in/withdrawable unit on request

General			
Standards			IEC/EN 60947
Protection against direct contact			Finger and back of hand proof to VDE 0106 Part 100
Climatic proofing			Damp heat, constant, according to IEC 60068–2–78 Damp heat, cyclical to IEC 60068–2–30
Ambient temperature			
Ambient temperature, Storage		°C	... 25...+70
Operation		°C	... 25...+70
Mechanical shock resistance (IEC/EN 60068–2–27)			
Shock resistance		g	20 (half–sinusoidal shock 20 ms)
Safe isolation to VDE 0106 Part 101 and Part 101/A1			
Between auxiliary contacts and main contacts		V AC	500
between the auxiliary contacts		V AC	300
Dimensions			
Weight			
Weight		kg	6,34
Mounting position			
Direction of incoming supply			As required
Degree of protection			

Device			In the operating controls area: IP20 (basic degree of protection)
Enclosures			With insulating surround: IP40, with door coupling rotary handle: IP66
Terminations			Tunnel terminal: IP10 Phase isolator and strip terminal: IP00
Utilization category			A
Maximum operating frequency		Ops/h	60
Lifespan			
Terminal cross-section			
Lifespan, mechanical	Operations		15000
Releases			
Electrical lifespan at 8 A/230 V AC/70 °C	Operations		1000
Rated operational voltage	$U_e$	V AC	1000
<b>Circuit-breakers</b>			
Rated impulse withstand voltage $U_{imp}$			
Main contacts		V	8000
Auxiliary contacts		V	6000
Rated operational voltage	$U_e$	V AC	690
3-pole	$I_u$	A	630
Overtoltage category/pollution degree			III/3
Rated insulation voltage	$U_i$	V	1000
For use in IT electrical power networks		V	690
<b>Switching capacity</b>			
Rated short-circuit making capacity			
240 V	$I_{cm}$	kA	187
400/415 V	$I_{cm}$	kA	105
440 V	$I_{cm}$	kA	74
525 V	$I_{cm}$	kA	53
690 V	$I_{cm}$	kA	40
up to 1000 V 50/60 Hz	$I_{cm}$	kA	17
Rated short-circuit breaking capacity $I_{cn}$			
$I_{cu}$ to IEC/EN 60947 operating sequence O-t-CO			

240 V 50/60 Hz	$I_{cu}$	kA	85
400/415 V 50/60 Hz	$I_{cu}$	kA	50
415 V AC	$I_{cu}$	kA	50
440 V 50/60 Hz	$I_{cu}$	kA	35
525 V 50/60 Hz	$I_{cu}$	kA	25
690 V 50/60 Hz	$I_{cu}$	kA	20
750 V DC	$I_{cu}$	kA	10
$I_{cu}$ to IEC/EN 60947 operating sequence O–t–CO–t–CO			
240 V 50/60 Hz	$I_{cs}$	kA	85
400/415 V 50/60 Hz	$I_{cs}$	kA	50
415 V AC	$I_{cs}$	kA	50
up to 440 V 50/60 Hz	$I_{cs}$	kA	35
525 V 50/60 Hz	$I_{cs}$	kA	13
up to 690 V 50/60 Hz	$I_{cs}$	kA	5
690 V AC	$I_{cs}$	kA	5
up to 1000 V 50/60 Hz	$I_{cs}$	kA	10
Maximum low-voltage h.b.c. fuse		A gG/gL	NZMN3–...250, 400: 400NZMN3–...630: 630
<b>Technical data, divergent from the products for the IEC market</b>			
Switching capacity NA switches (UL489, CSA 22.2 No. 5.1)			
240 V 60 Hz		kA	85
480V 60Hz		kA	42
600 V 60 Hz		kA	35
Utilization category to IEC/EN 60947–2			A
Utilization category			A
Rated short-time withstand current			
t = 0.3 s	$I_{cw}$	kA	3,3
t = 1 s	$I_{cw}$	kA	3,3
Lifespan, mechanical	Operations		15000
Maximum operating frequency			
Max. operating frequency		Ops/h	60
Lifespan, electrical			
AC–1			
400/415 V 50/60 Hz	Operations		5000
415 V	Operations		5000
690 V 50/60 Hz	Operations		3000

AC—3			
400/415 V 50/60 Hz	Operations		2000
415 V	Operations		2000
690 V 50/60 Hz	Operations		2000
DC – –1			
500 V DC	Operations		1000
Current heat loss per pole at $I_u$		W	40
Current heat loss (3-pole) at $I_u$		W	40
Overload releases			
to IEC/EN 60947, VDE 0660			
Temperature compensation			0
Frequency range		ms	< 10
<b>Terminal capacities</b>			
Standard equipment			Screw terminal
Accessories			Box terminal Tunnel terminal Connection on rear
Rated power of coil			
Box terminal			
Solid		mm <sup>2</sup>	2 × 16
Stranded		mm <sup>2</sup>	1 × (35 – 240) 2 × (25 – 120)
Tunnel terminal			
Solid		mm <sup>2</sup>	1 × (16 – 185)
Stranded			
Single hole		mm <sup>2</sup>	1 × (25 – 185)
Double hole fitting		mm <sup>2</sup>	1 × (50 – 240) 2 × (50 – 240)
Bolt terminal and rear-side connection			
Direct on the switch			
Solid		mm <sup>2</sup>	1 × 16 2 × 16
Stranded		mm <sup>2</sup>	1 × (25 – 240) 2 × (25 – 240)
Connection width extension		mm <sup>2</sup>	2 × 300
Al conductors, Cu cable			
Tunnel terminal			
Solid		mm <sup>2</sup>	1 × 16
Stranded			

Single hole		mm <sup>2</sup>	1 × (25 – 185) In base alla casa produttrice dei cavi, collegabile fino a 240 mm <sup>2</sup>
Double hole fitting		mm <sup>2</sup>	1 × (50 – 240) 2 × (50 – 240)
Bolt terminal and rear-side connection			
Direct on the switch			
Solid		mm <sup>2</sup>	1 × 16 2 × (10 – 16)
Stranded		mm <sup>2</sup>	1 × (25 – 120) 2 × (25 – 120)
Cu strip (number of segments x width x segment thickness)			
Box terminal			
	min.	mm <sup>2</sup>	6 × 16 × 0.8
	max.	mm <sup>2</sup>	10 × 24 × 1.0 + 5 × 24 × 1.0 (2 ×) 8 × 24 × 1.0
Bolt terminal and rear-side connection			
Flat copper strip, with holes	min.	mm	6 × 16 × 0.8
Flat copper strip, with holes	max.	mm	10 × 32 × 1.0 + 5 × 32 × 1.0
Connection width extension		mm <sup>2</sup>	(2 ×) 10 × 50 × 1.0
Copper busbar (width × thickness)			
Bolt terminal and rear-side connection			
Screw connection			M10
Direct on the switch			
	min.	mm <sup>2</sup>	20 × 5
	max.	mm <sup>2</sup>	30 × 10 + 30 × 5
Connection width extension			
Connection width extension	max.	mm <sup>2</sup>	2 × (10 × 50)
<b>Notes</b>			
<b>Notes</b>			For rated operational voltage the following applies: DC voltage values on request For switching capacity of NA switches with NZM...1–...NA the following applies: 480Y/277 V from 60 A For rated operational current

		<p>AC-3 at NZMB2, NZMN2, NZMH2, NZM4 the following applies: 400 V: max. 650 kW; 600 V: max. 600 kW</p> <p>For switching capacity of NA switches with NZML2 and NZML3 the following applies: current limiting switch to UL489</p> <p>For overload release temperature compensation NZM2 thermomagnetic the following applies: with NZM1...1-...160: 0.4</p> <p>For switching capacity of NA switches with NZML4 at 240 V 60 Hz the following applies: please enquire</p> <p>The current heat loss per pole ratings refer to the maximum current rating of the frame size.</p>
--	--	--

## Mounting position

Vertical and 90° in all directions

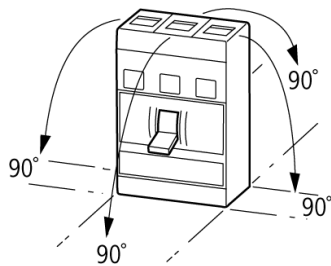

With plug-in adapter NZM2, N(S)2: vertical, 90° right/left

with residual current release, NZM2: vertical and 90° to all directions

With withdrawable unit, NZM3, N(S)3: vertical, 90° left, NZM4, N(S)4: vertical, with remote operator: NZM2, N(S)2, NZM3, N(S)3, NZM4, N(S)4: vertical and 90° to all directions

## Overview

### Basic equipment

Box terminal ● — — —

Screw connection — ● ● ●

### Accessories

Box terminal — ● ● —

Screw connection ● — — ●

Tunnel terminal ● ● ● ●

Connection on rear ● ● ● ●

Flat conductor terminal — — — ●

## Notes

For rated operational voltage switching on 3 contacts the following applies: DC correction factor for instantaneous release response value NZM1: 1.25, NZM2: 1.35

Setting for  $I_i$  at DC = setting  $I_i$  AC/DC correction factor

Details apply for 3-pole system protection circuit-breaker with thermomagnetic release NZM(H)1(2)-A...

### Switching of one pole via two series contacts

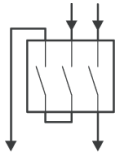

### Switching of one pole via three series contacts

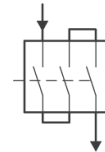

For NA switch switching capacity with NZM...1-...(C)NA the following applies: 480 Y/277 V from 60 A

For AC-3 rated operational current with NZM4 the following applies: 400 V: max. 650 kW; 690 V: max. 600 kW

For NA switch switching capacity with NZML2 and NZML3 the following applies: Current Limiting switch to UL489

For 3-pole system protection circuit-breaker the AC-3 specification is not applicable

For NA switch switching capacity with NZML4 at 240 V 60 Hz the following applies: on request

For current heat loss per pole the specification refers to the maximum nominal current of the frame size.

For 3-pole system protection circuit-breaker the following applies: 690 V

For 3-pole system protection circuit-breaker the following applies: 400/415 V 7500 switching operations

Maximum back-up fuse, if the expected short-circuit currents at the installation location exceed the switching capacity of the circuit-breaker.

≅ 1600 A

Higher switching capacity on request

---

## Notes

XSV = plug-in unit

XAV = withdrawable unit

TM = thermomagnetic

E = electronic

---

## Dimensions



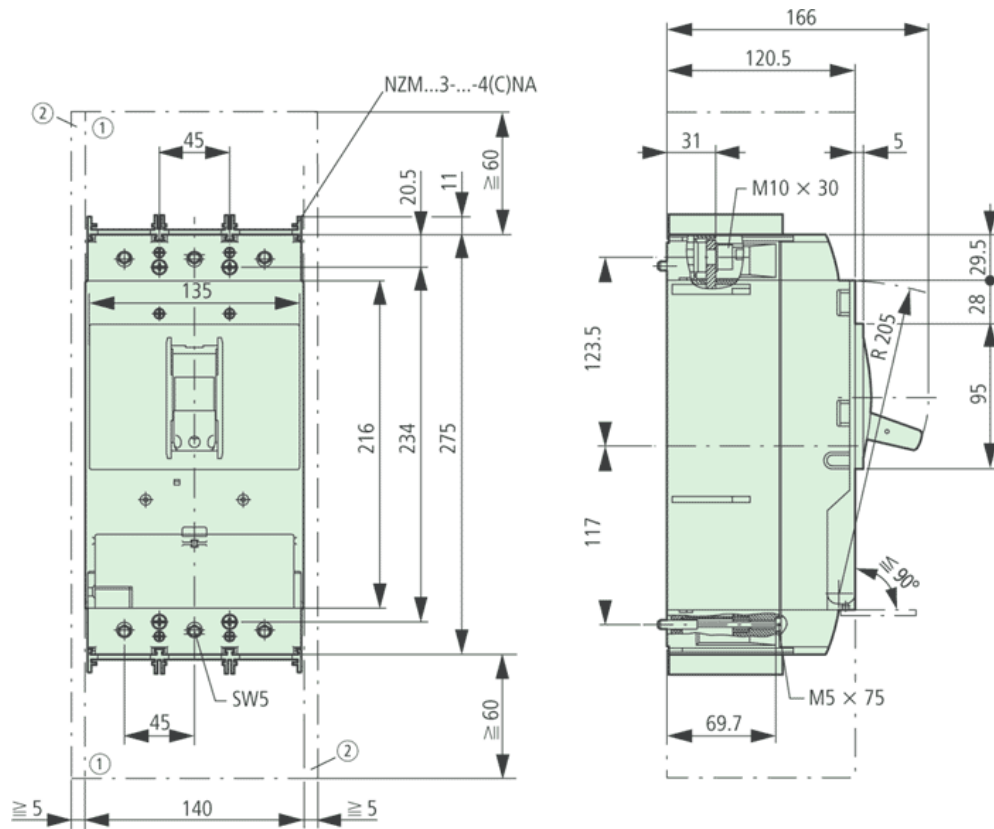

Arcing chamber, minimum clearing to neighbouring parts 60 mm  
 Minimum clearance from adjacent parts 5 mm

## Dimensions

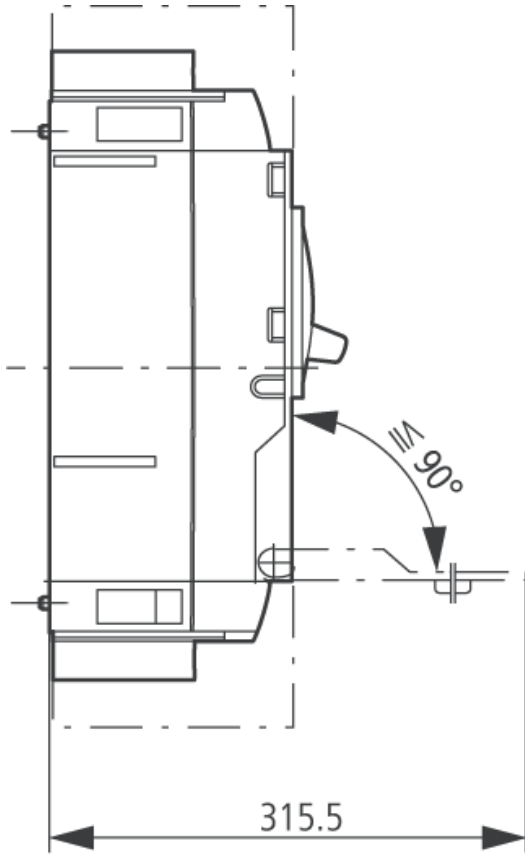

**Characteristic curve**

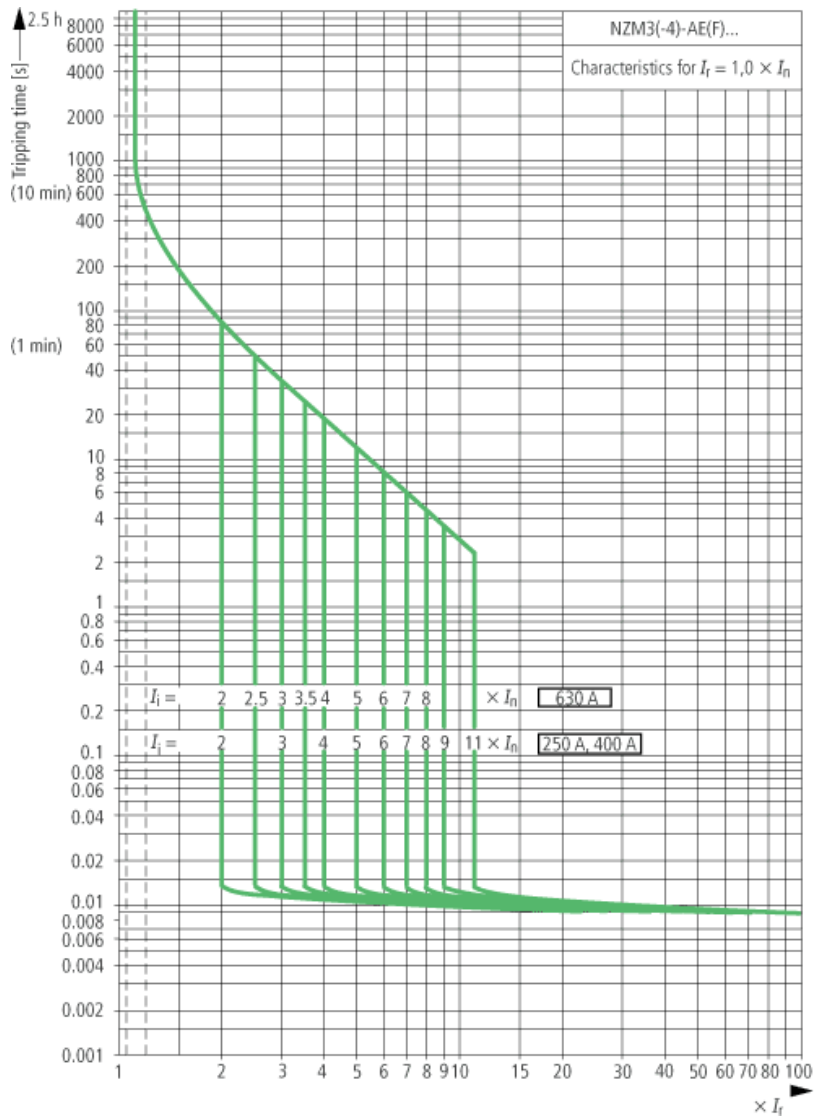

## System and line protection with NZM3

### Characteristic curve

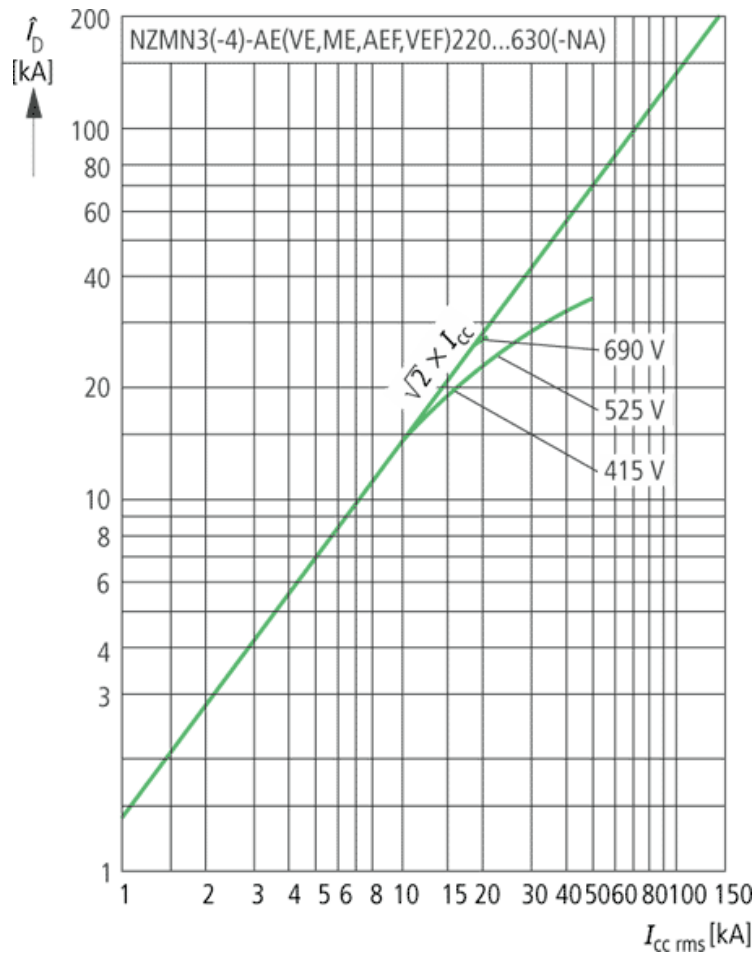



---

Let-through current  $\hat{i}_D$   
 Let-through energy  $I^2t$

---

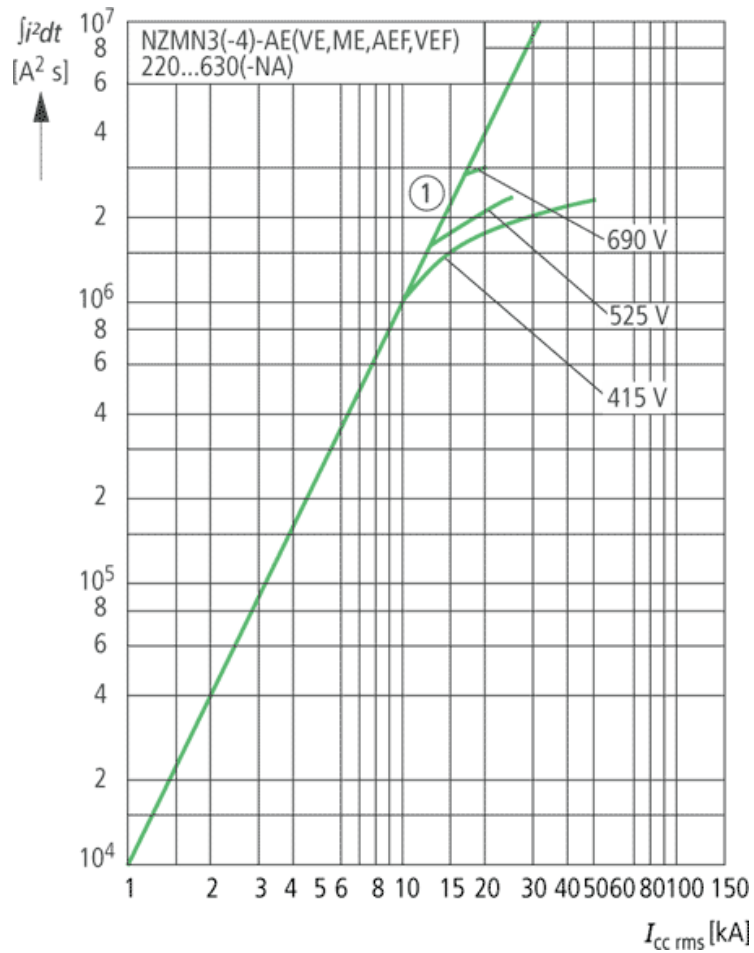
**Characteristic curve**



---

1 half-shaft

---

Moeller GmbH, Hein-Moeller-Str. 7-11, D-53115 Bonn  
 E-Mail: [catalog@moeller.net](mailto:catalog@moeller.net), Internet: [www.moeller.net](http://www.moeller.net), <http://catalog.moeller.net>  
 HPL-C2007G V2.1 © 2007 by Moeller GmbH