



Part no. IZM40N4-P40W
Catalog No. 124256

Delivery program

Product range			Air circuit-breakers/switch-disconnectors
Product range			Open circuit-breakers
Current Range			4000 to 6300 A
Protective function			Universal protection and power measurement
Installation type			Withdrawable
Construction size			IZM40
Standard/Approval			IEC
Number of poles			4 pole
Degree of Protection			IP20, IP55 with protective cover, IP41 with door sealing frame
Rated current = rated uninterrupted current	$I_n = I_u$	A	4000
Rated ultimate short-circuit breaking capacity up to 440V/690V 42/42	I_{cu}	kA	85
Rated service short-circuit breaking capacity up to 440V/690V 42/42	I_{cs}	kA	85
Overload release, min.	I_r	A	1600
Overload release, max.	I_r	A	4000
Non-delayed	$I_j = I_n \times \dots$		2 - 10, OFF
			
Delayed	$I_{sd} = I_r \times \dots$		2 - 10
			

Notes

Including rear connection main terminals and secondary terminal blocks according to ordered breaker options.

Note concerning the product

Cassette needs to be ordered separately.

Technical data

General

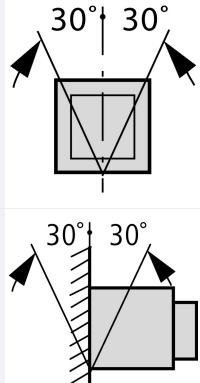
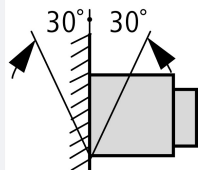
Standards			IEC/EN 60947
Ambient temperature			
Storage	θ	°C	-25 - +70 (device with LCD-display -20 - +70)
Operating (open)		°C	-25 - +70 (device with LCD-display -20 - +70)
Mounting position			
			
Utilization category			B
Degree of Protection			IP20, IP55 with protective cover, IP41 with door sealing frame
Direction of incoming supply			as required

Main conducting paths

Rated current = rated uninterrupted current	$I_n = I_u$	A	4000
Rated uninterrupted current at 50 °C	I_u	A	4000

Rated uninterrupted current at 60 °C	I_u	A	4000
Rated uninterrupted current at 70 °C	I_u	A	3776
Rated impulse withstand voltage	U_{imp}	V AC	12000
Rated operational voltage	U_e	V AC	690
Use in IT electrical power networks up to $U = 440$ V	I_{IT}	kA	48
Overvoltage category/pollution degree			III/3
Rated insulation voltage	U_i	V	1000

Switching capacity

Rated short-circuit making capacity	I_{cm}		
up to 440 V 50/60 Hz	I_{cm}	kA	178
up to 690 V 50/60 Hz	I_{cm}	kA	137
Rated short-time withstand current 50/60 Hz			
t = 1 s	I_{cw}	kA	85
t = 3 s	I_{cw}	kA	65
Rated short-circuit breaking capacity I_{cn}	I_{cn}		
IEC/EN 60947 operating sequence I_{cu} 0-t-CO			
up to 240 V 50/60 Hz	I_{cu}	kA	85
up to 440 V 50/60 Hz	I_{cu}	kA	85
up to 690 V 50/60 Hz	I_{cu}	kA	65
IEC/EN 60947 operating sequence I_{cs} 0-t-CO-t-CO			
up to 240 V 50/60 Hz	I_{cs}	kA	85
up to 440 V 50/60 Hz	I_{cs}	kA	85
up to 690 V 50/60 Hz	I_{cs}	kA	65
Operating times			
Closing delay via spring release		ms	30
Break times		ms	40
Total opening delay via shunt release		ms	35
Total opening delay via undervoltage release		ms	35/70
Total opening delay on non-delayed short-circuit release (up to complete arc quenching)		ms	35
Maximum operating frequency	Operations/h		60
Heat dissipation at rated current I_n			
Fixed mounting		W	560
Withdrawable units (switch with cassette)		W	1100

Weight

Fixed mounting			
3-pole		kg	83
4-pole		kg	105
Withdrawable			
3-pole		kg	98
4-pole		kg	121
Cassette			
3 pole		kg	60
4 pole		kg	73

Terminal capacities

Copper bar			
Fixed mounting			
Black		mm	4 x 10 x 100
Withdrawable units			
Black		mm	4 x 10 x 100
			Permissible continuous current for circuit-breakers operating in switchboards at various internal ambient temperatures. The switchboard's internal ambient temperature should be estimated using the calculation methods of IEC regulation.
Other technical data (sheet catalogue)			Tripping characteristics for universal protection and power quality Notes - tripping characteristics

Design verification as per IEC/EN 61439

Technical data for design verification		
Operating ambient temperature max.	°C	-25
Operating ambient temperature max.	°C	70

Dimensions

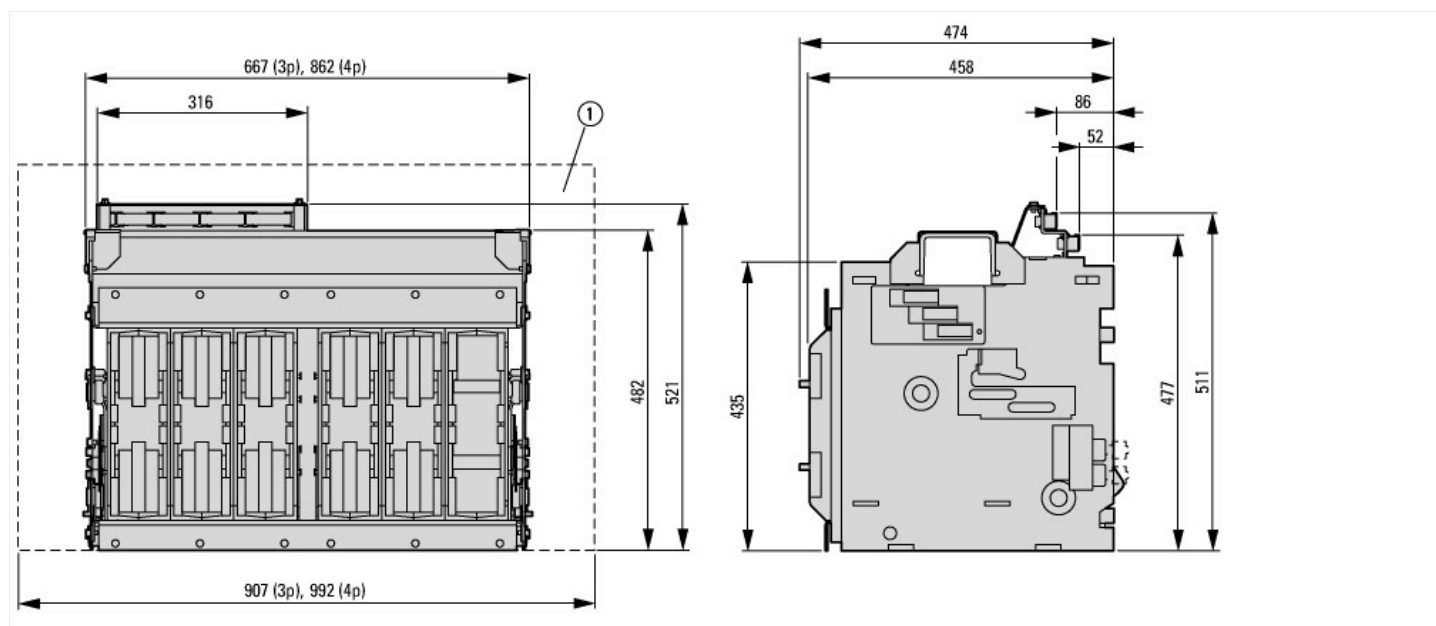

① Recommended minimum enclosure size (not shown to scale)

Additional product information (links)

Notes - tripping characteristics	http://ecat.moeller.net/flip-cat/?edition=HPLEN&startpage=18.88
Tripping characteristics for universal protection and power quality	http://ecat.moeller.net/flip-cat/?edition=HPLEN&startpage=18.82