

Circuit-breaker, 3p, 1000A, fixed

Part no. IZM32N3-A10F
 Catalog No. 123940

Delivery program

Product range			Air circuit-breakers/switch-disconnectors
Product range			Open circuit-breakers
Current Range			4000 to 6300 A
Protective function			System protection
Installation type			Fixed
Construction size			IZM32
Standard/Approval			IEC
Number of poles			3 pole
Degree of Protection			IP20, IP55 with protective cover, IP41 with door sealing frame
Rated current = rated uninterrupted current	$I_n = I_u$	A	1000
Rated ultimate short-circuit breaking capacity up to 440V/690V 42/42	I_{cu}	kA	85
Rated service short-circuit breaking capacity up to 440V/690V 42/42	I_{cs}	kA	85
Overload release, min.	I_r	A	400
Overload release, max.	I_r	A	1000
Non-delayed	$I_j = I_n \times \dots$		2 - 10
			
Notes			
Including rear connection main terminals and secondary terminal blocks according to ordered breaker options.			

Technical data

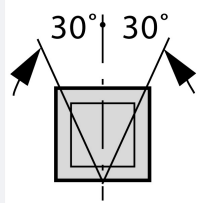
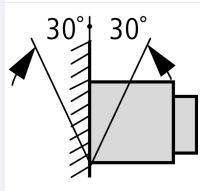
General			
Standards			IEC/EN 60947
Ambient temperature			
Storage	θ	°C	-25 - +70 (device with LCD-display -20 - +70)
Operating (open)		°C	-25 - +70 (device with LCD-display -20 - +70)
Mounting position			 
Utilization category			B
Degree of Protection			IP20, IP55 with protective cover, IP41 with door sealing frame
Direction of incoming supply			as required

Main conducting paths

Rated current = rated uninterrupted current	$I_n = I_u$	A	1000
Rated uninterrupted current at 50 °C	I_u	A	1000
Rated uninterrupted current at 60 °C	I_u	A	1000
Rated uninterrupted current at 70 °C	I_u	A	1000
Rated impulse withstand voltage	U_{imp}	V AC	8000
Rated operational voltage	U_e	V AC	690

Use in IT electrical power networks up to U = 440 V	I _{IT}	kA	13
Overvoltage category/pollution degree			III/3
Rated insulation voltage	U _i	V	1000

Switching capacity

Rated short-circuit making capacity	I _{cm}		
up to 440 V 50/60 Hz	I _{cm}	kA	178
up to 690 V 50/60 Hz	I _{cm}	kA	179
Rated short-time withstand current 50/60 Hz			
t = 1 s	I _{cw}	kA	85
t = 3 s	I _{cw}	kA	65
Rated short-circuit breaking capacity I _{cn}	I _{cn}		
IEC/EN 60947 operating sequence I _{cu} 0-t-CO			
up to 240 V 50/60 Hz	I _{cu}	kA	85
up to 440 V 50/60 Hz	I _{cu}	kA	85
up to 690 V 50/60 Hz	I _{cu}	kA	85
IEC/EN 60947 operating sequence I _{cs} 0-t-CO-t-CO			
up to 240 V 50/60 Hz	I _{cs}	kA	85
up to 440 V 50/60 Hz	I _{cs}	kA	85
up to 690 V 50/60 Hz	I _{cs}	kA	85
Operating times			
Closing delay via spring release		ms	30
Break times		ms	40
Total opening delay via shunt release		ms	35
Total opening delay via undervoltage release		ms	35/70
Total opening delay on non-delayed short-circuit release (up to complete arc quenching)		ms	35
Maximum operating frequency	Operations/h		60
Heat dissipation at rated current I _n			
Fixed mounting		W	50
Withdrawable units (switch with cassette)		W	95

Weight

Fixed mounting			
3-pole		kg	68
4-pole		kg	86
Withdrawable			
3-pole		kg	80
4-pole		kg	102
Cassette			
3 pole		kg	34
4 pole		kg	38

Terminal capacities

Copper bar			
Fixed mounting			
Black		mm	2 x 5 x 60
Withdrawable units			
Black		mm	2 x 5 x 60
			Permissible continuous current for circuit-breakers operating in switchboards at various internal ambient temperatures. The switchboard's internal ambient temperature should be estimated using the calculation methods of IEC regulation.
Other technical data (sheet catalogue)			Tripping characteristics for selective protection Notes - tripping characteristics

Design verification as per IEC/EN 61439

Technical data for design verification			
Operating ambient temperature max.		°C	-25
Operating ambient temperature max.		°C	70

Dimensions

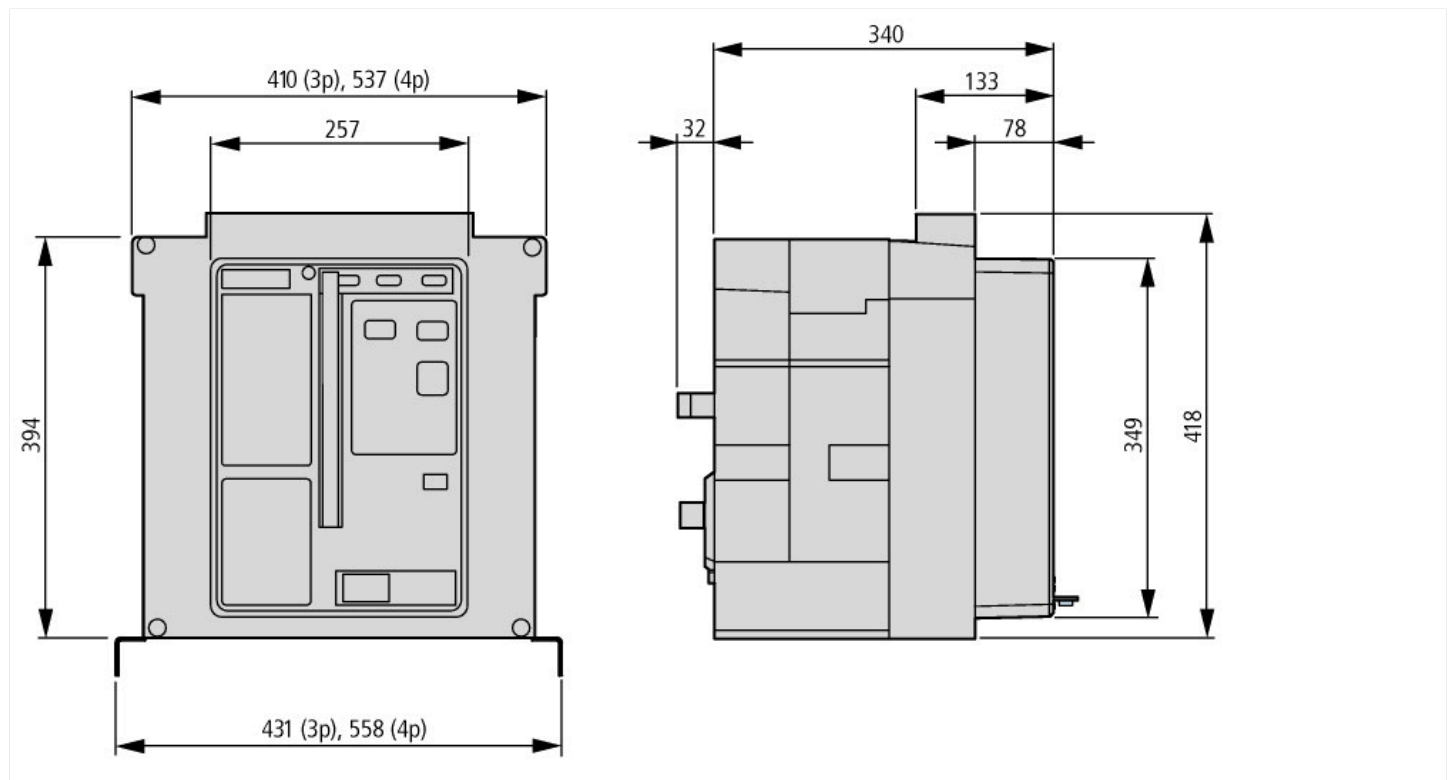

Additional product information (links)

Tripping characteristics for selective protection	http://ecat.moeller.net/flip-cat/?edition=HPLEN&startpage=18.78
Notes - tripping characteristics	http://ecat.moeller.net/flip-cat/?edition=HPLEN&startpage=18.88