

ENGINEERING
TOMORROW



Installation Guide

Danfoss Enterprise Manager AK-EM 800

ADAP-KOOL® Refrigeration Control System

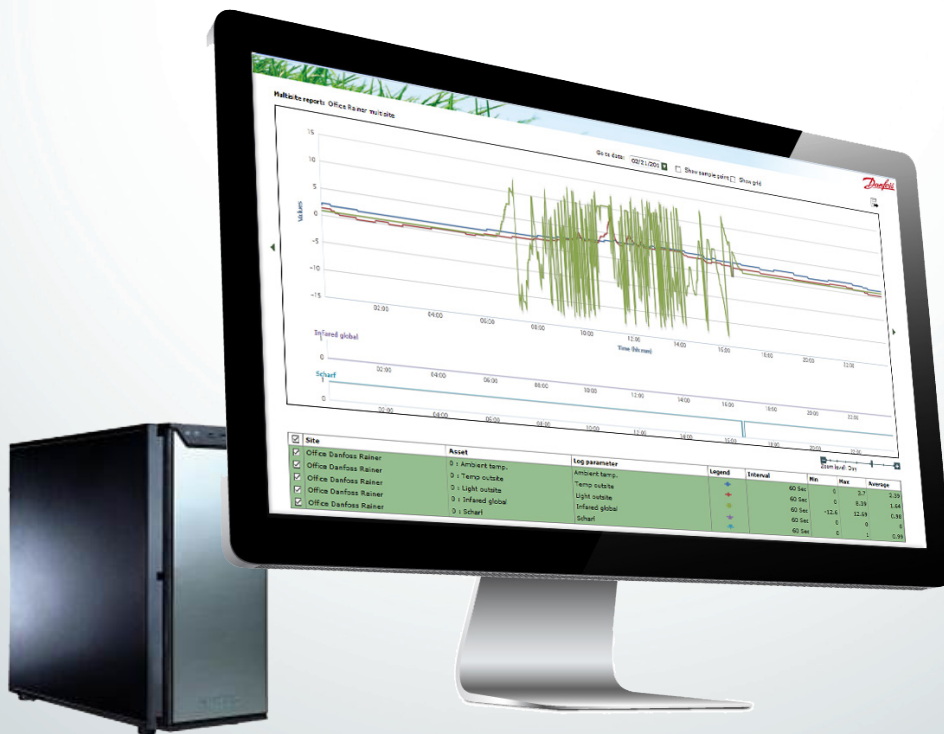

Document history

Document	Notes
USCO.PI.R1.F1.02	First document release
USCO.PI.R1.F2.02	Minor updates
USCO.PI.R1.F3.02	Updates. v. 1.21
USCO.PI.R1.F4.02	Updates. v. 1.31
USCO.PI.R1.F5.02	Updates. v. 2.01
USCO.PI.R1.F6.02	Updates. v. 2.11
USCO.PI.R1.F7.02	Updates. v. 2.21
USCO.PI.R1.F8.02	Updates. v. 2.23
USCO.PI.R1.F9.02	Updates. v. 2.24

Contents

Document history	2
Introduction	3
Target PC specifications	3
System Layout	5
Direct connection (AKM agent not required)	5
Legacy support (AKM agent required).....	5
Deployment diagram of AK-EM 800	6
Installation of AK-EM 800	7
Start Installation.....	8
Non-distributed installation:	10
Distributed installation.....	10
Database server.....	11
Application server	11
AKM-Agent installation	14
System upgrade.....	19
Upgrade AK-EM 800.....	20
Upgrade AKM Agent.....	20
Starting or restarting TOMCAT (optional or after upgrade from Version 1.xx to 2.0)	21
Setting up the memory of TOMCAT (optional).....	22
Uninstall AK-EM 800 (optional)	23
AK-EM 800	23
Uninstall AKM Agent (optional).....	25

Introduction

The AK-EM 800 is an Enterprise Management solution from Danfoss for the food retail industry. The AK-EM 800 is a multi-user, multi-site server PC application which provides alarm management and automatic data collection, together with reporting features.

This document is designed to guide you through the installation of your AK-EM 800. This guide will also cover the installation of the included AKM agent, which is required to support legacy Danfoss control devices (described later in this guide).

Warning: Version 2.01 and higher introduces a new licensing model. If you are currently running a version of AK-EM 800 below v2.0.1 and wish to upgrade a valid license will be required to continue operation. Please consult with the AK-EM 800 User Guide for more details on license management.

Target PC specifications

The minimum computer specification is described below. AK-EM 800 can run on a real and also on a virtual server. Database and application can be installed on different machines, but both machines must be in the same local area.

For best performance, Danfoss recommends using a 64Bit version of Windows OS.

Product	Configuration	Load factor	Details
AK-EM 800 Server (same for AKM-Agent)	Hardware	<50 networks	<ul style="list-style-type: none"> • Processor - i3 OR i5 • RAM – 6 GB or above • Storage – 300GB or above
		>50 networks	<ul style="list-style-type: none"> • Processor – i5 OR i7 OR above • RAM – 12 GB or above • Storage – 1 TB or above
	Software	<50 networks	<ul style="list-style-type: none"> • Windows 7 64 bit / Windows Server OS 64 bit (<i>AK-EM 800 only</i>) • Tomcat memory – 4 GB
		>50 networks	<ul style="list-style-type: none"> • Windows 7 Enterprise 64 bit / Windows Server 2008 R2 or Above (64 bit) (<i>AK-EM 800 only</i>) • Tomcat memory – 4 GB or above
Client Computer Configuration	Browser	<ul style="list-style-type: none"> • Mozilla Firefox 39.0 or higher • IE 11 	
	Screen resolution	<ul style="list-style-type: none"> • 1024*768 	
	RAM	<ul style="list-style-type: none"> • 2 GB or above 	

Front End	Versions Supported
AK-SC 255	2.211 or higher
AK-SC 355	3.091 or higher
AK-SM 800	8.011 or higher
AKM	7.41

To get an impression how much sites can be logged in AK-EM 800 please see the following table.

One example: If the average logs per site is a 450 and the logs are collected one time per day, it will be possible to log data from 710 sites. But that means also, if AK-EM 800 has to loge the data twice per day, the amount of sites will decrease.

Site Table (64 Bit Version)	
"Based on average of 320 logs/site collected by AK-EM 800 1 log collection per 24 hrs 20 sites collected in parallel"	
Average number of logs	Number of sites
650	492
700	457
750	426
800	399
850	376
900	355
950	336
1000	320

System Layout

Direct connection (AKM agent not required)

The AK-EM 800 provides a direct communications connection path to AK-System Manager 800 series of front end controllers. AKM agent installation not required when using the AK-SM 800 series.

In addition, the Danfoss AK-SC 255/AK-SC 355 (latest firmware versions) are also supported via direct connect path.

Legacy support (AKM agent required)

For applications that use AK-SM 720, AK-SM 350, AKA Gateways, and the Danfoss m2 (known as legacy systems), it is still possible to connect to the AK-EM 800, via the use of the AKM-Agent. The use of the AKM agent allows for alarms and history logs from these systems to be synchronized between the existing AKM PC installation and the AK-EM 800.

Under this application the AK-EM 800 is connected and communicates to an installed AKM agent, which must be installed on designated AKM PC. There can be more than one AKM PC installation that communicates to the AK-EM 800. Each AKM PC will require installation of the AKM agent.

Direct connection AK-SC 255 /AK-SC 355 / AK-SM 8xx

Front End	Versions Supported
AK-SC 255	2.211 or higher
AK-SC 355	3.091 or higher
AK-SM 800	8.011 or higher
AKM	7.41

The following picture describes the System Layout.

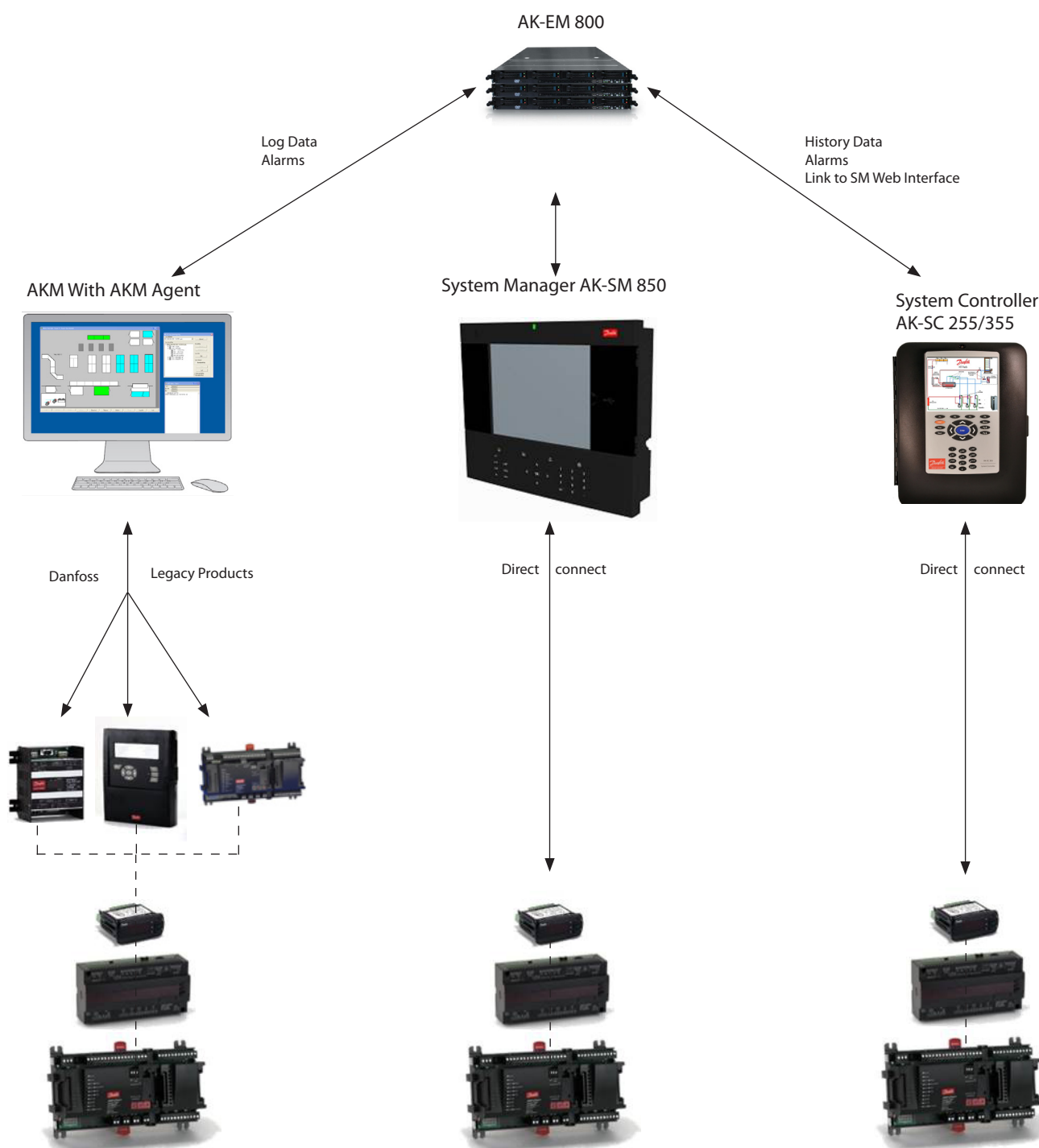

Deployment diagram of AK-EM 800

Distributed installation.

Application and database are on 2 different machines

Recommended LAN speed is 1 G-Byte, to get the best performance

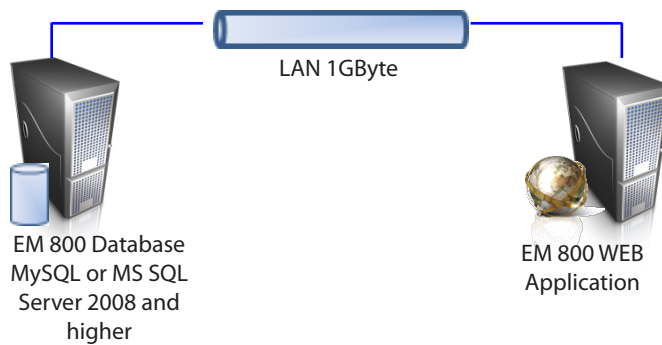

Non distributed installation.

Application and database are on the same machine.



Installation of AK-EM 800



There is one wizard based installation file for both AK-EM 800 and AKM Agent available in 32 bit or 64 bit version (64 bit recommended).

Up to max. 50 sites the installation can be done on one single PC. Above 50 sites a distributed installation (application and database on 2 different PC's) is strongly recommended.

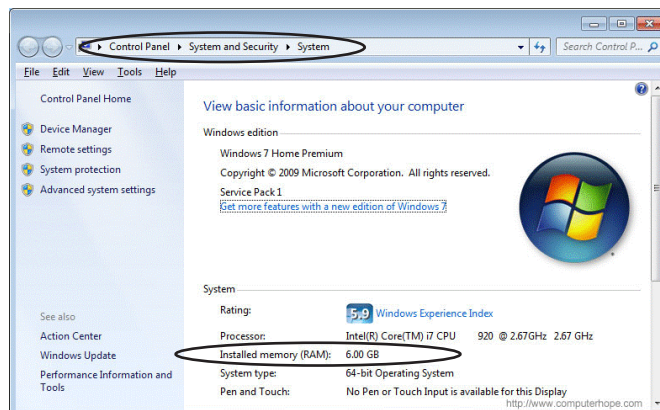

The Windows firewall must be switched off or the settings must be correct to allow used ports for communication. You will be required to add ports allowed to receive alarms from sites.

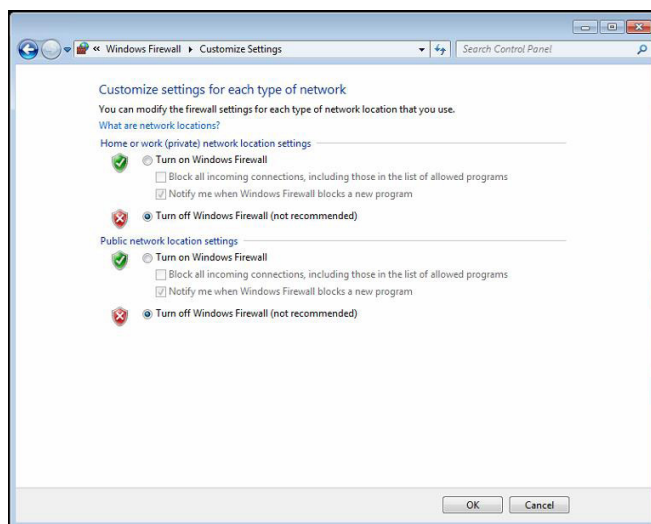

Start Installation

The following steps need to be executed in order to install AK-EM 800 on a system:
Double click on '**AK-EM 800 installer 64-bit version-x.xx.exe**'.
It will open a window as shown below. Click on "Yes" button to continue with the installation.

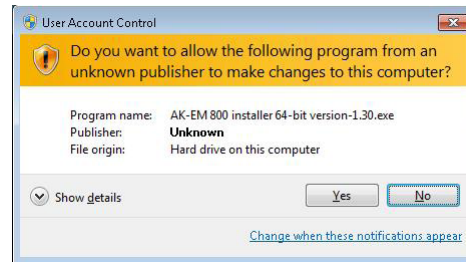

Please read the instructions and click on the 'Next' button to continue.

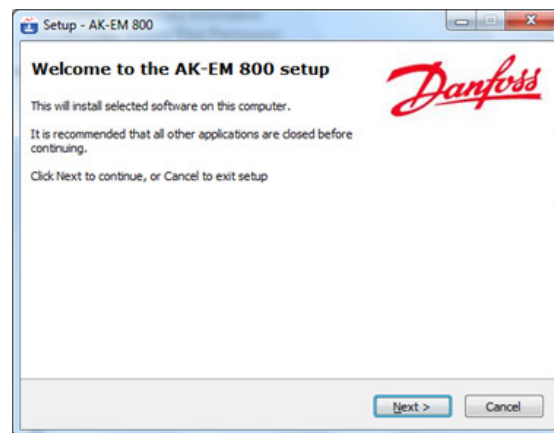

Please read the license agreement

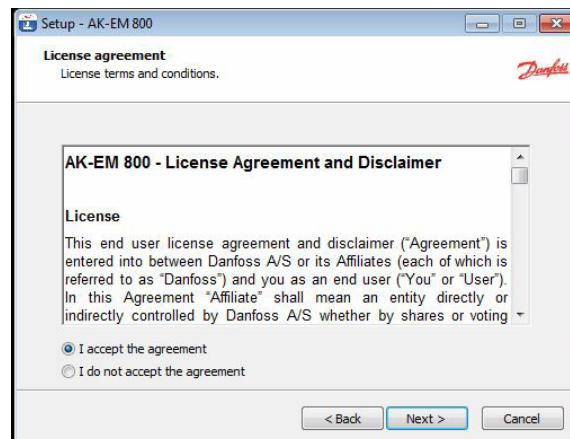

Accept the agreement and choose next.

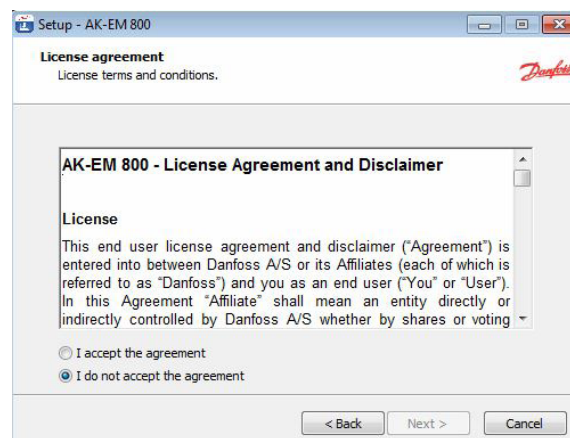

If **AKM** is installed on the machine, only then the **AKM-Agent** option will be visible to the user, else **AK-EM 800** option is visible to user. Only one option will appear at a time (that is easy to understand).

The disk space mentioned in the above dialog is the minimum amount of disk space required to install the application successfully.

Recommended free hard disk space for AK-EM 800 software to function properly is 20 GB.

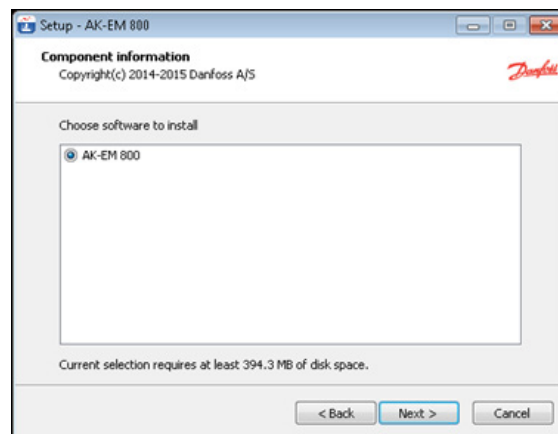

After clicking on the "Next" button this screen will appear where the user shall be able to select a language for the installation process (default language is English). Select language of your choice and click on "Next" to continue.

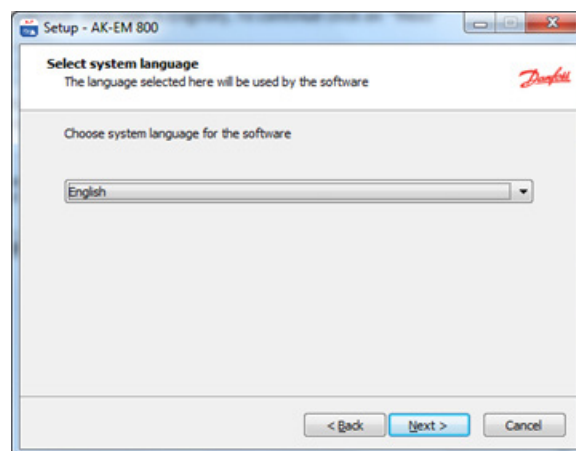

After selection of language, the user shall be provided with the option of installing the application either in a distributed or non-distributed environment. Non-distributed installation will install the AK-EM 800 application and the database application on the same machine whereas the distributed installation will install them on separate machines.

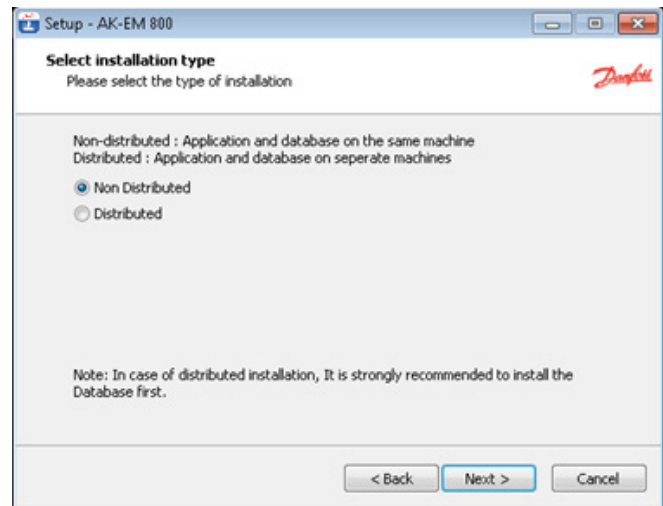

Non-distributed installation:

If the non-distributed installation is selected, following screen will appear:

If the user's machine has MySQL or MS SQL already installed, click on "Yes" otherwise click on "No".

- If clicked on "Yes", the user will be required to browse to the path where the database is installed and enter the existing database credentials. If the credentials are valid, test credential would be successful
- If clicked on "No", the user will only be required to enter the new credentials for the database.
Note: Do not forget this password.

Click "Next" to continue with the non-distributed installation or "Back" to change previous settings.

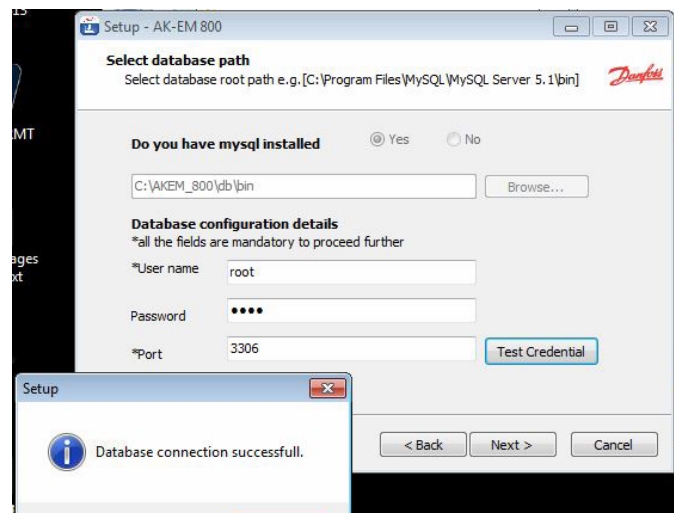

Distributed installation

If distributed installation is selected, following screen will appear:

The user will be asked to select the server type to install on the machine. If the user wishes to install database on the machine, select "Database server", otherwise if the user wishes to install the application, select "Application server"

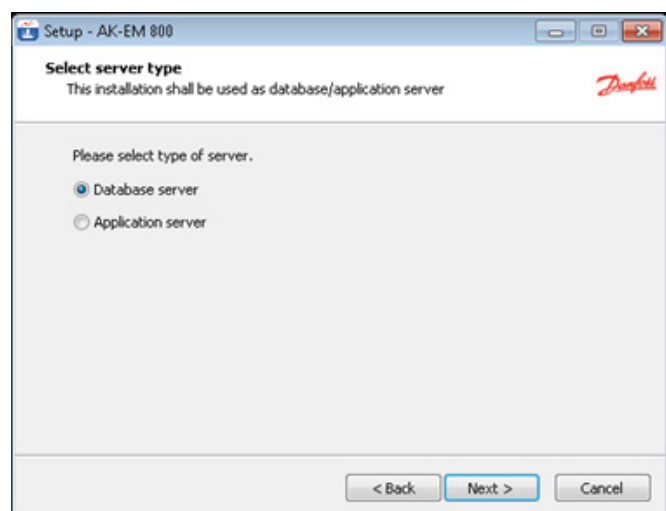

Database server

If the user has selected "Database server":
 Select database screen for selection of the database to be installed on the machine as shown below will appear

Click "Next" to continue.

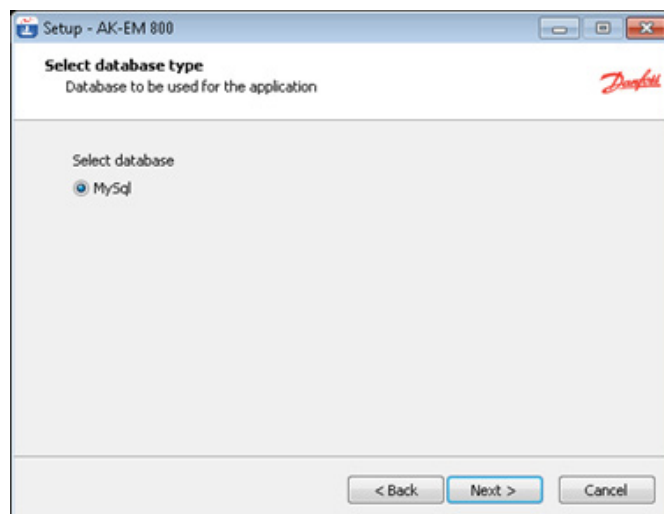

- If the machine has the database already installed, the user will be required to click on "Yes", browse to the path where the database is installed and enter the existing database credentials.
- If the database is not installed, click "No" and provide new credentials for the database.

The screen shot is as shown here.

Press "Test Credentials" to test the connection to the database.

Click "Next" to continue.

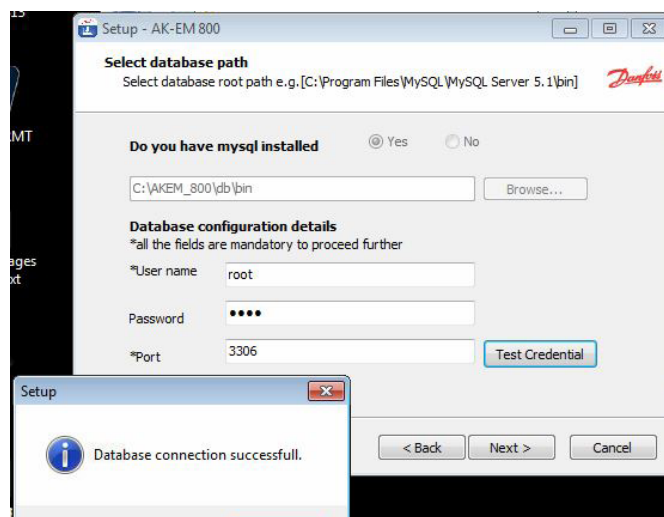

Application server

If the user has selected "Application server", the following screen appears where user would be required to provide the Ipaddress of the machine where the database is installed along with the database credentials.

Click "Next" to continue.

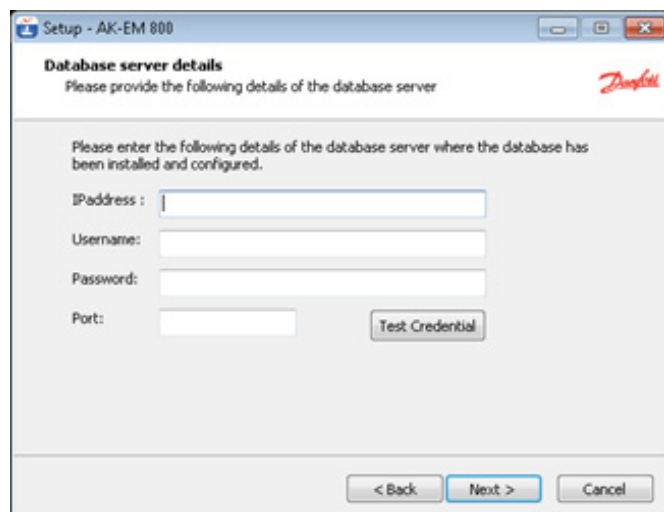

In both the cases, that is, in case of distributed as well as non-distributed installation, after performing the respective steps mentioned above and clicking on "Next", the directory in which the application is to be installed will be asked to the user as shown in the following screen shot. User can select the directory of his choice.

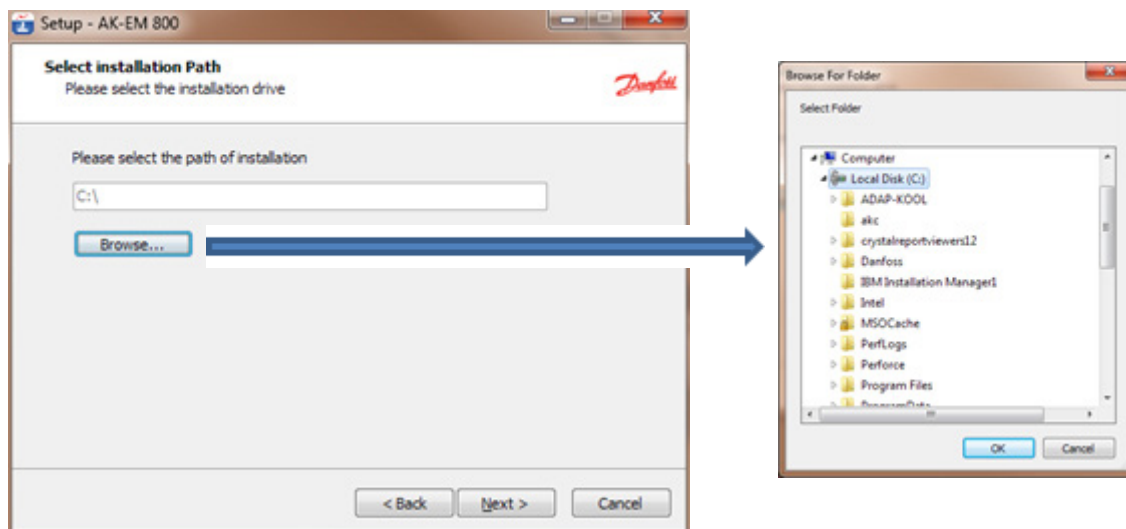

Click on "Next" to continue or "Back" to change previous settings. Here, user can select one or more additional tasks to perform (like creation of shortcut on desktop and start menu) from the list as shown in the screen shot below.

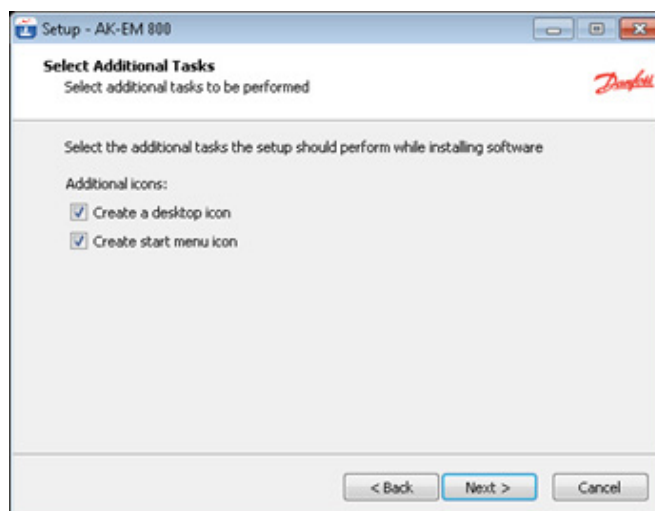

Click on "Next" to continue or to change any of the previously chosen settings user can click on "Back" button.

Click on the 'Install' button to continue with the installation.

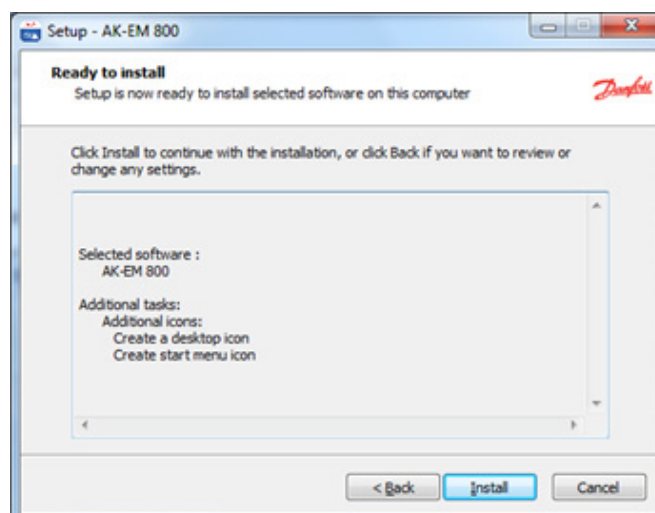

Please wait till the installation completes. During this process the installer will extract and install all the required software silently in background.

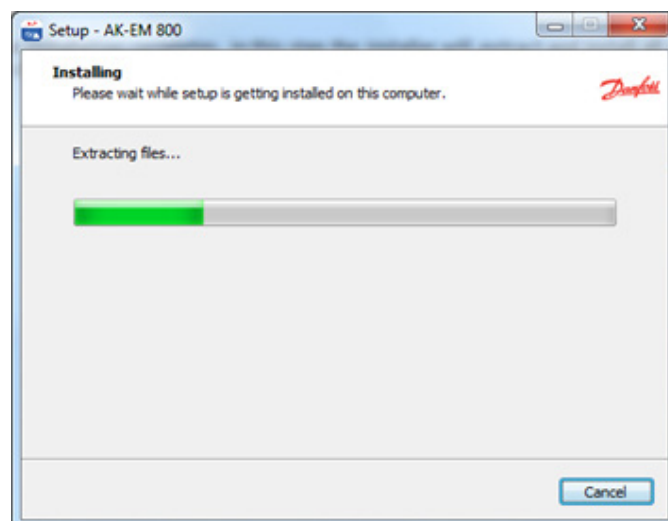

This is the final screen of installation process. User can select the option(s) provided on the screen to see the status of the installation and/or to launch the application.

Click on 'Finish' button to complete the installation process. If the user does not wish to launch AK-EM 800 and/or see the status file, he can uncheck the option(s) accordingly.

Note: On some servers, the IP Address of the host may not be retrieved successfully into the status file by the installer. This could be because of the different network configurations (DHCP/DNS, IPv6 etc) on some servers. This will not create any problems in the functioning of AK-EM 800 .

Attention !

Version 2.01 and higher will require a restart of the Tomcat services (see chapter 'Restart Tomcat')

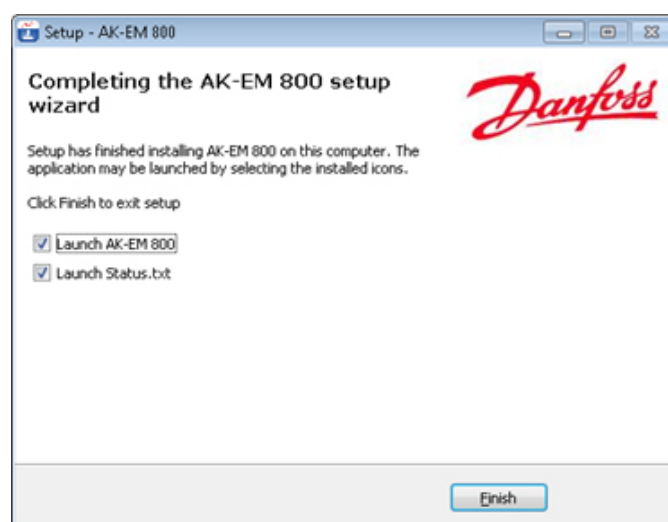

AKM-Agent installation



Please perform the following steps to install AKM-Agent:
 Double click on '**AK-EM 800 installer 64-bit version-x.xx.exe**'.
 A window as shown below will appear. Click on 'Yes' button to continue with the installation.

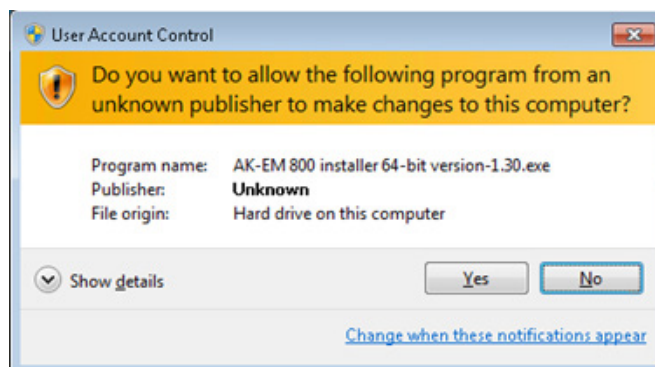

Please go through the instructions and click on the 'Next' button to continue.

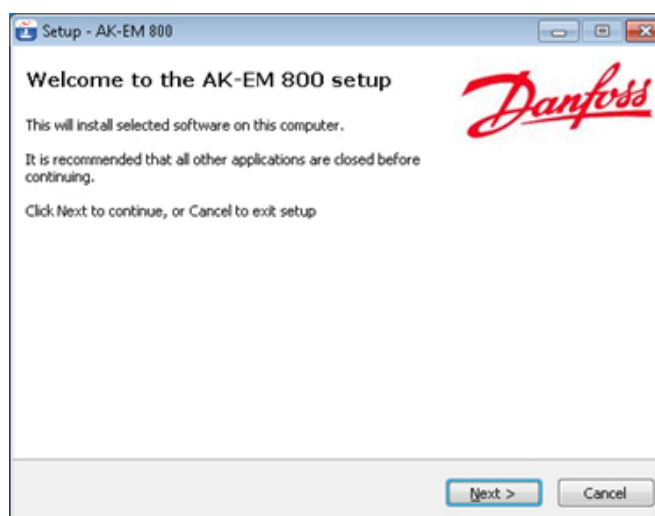

If **AKM** is installed on the machine, only then the **AKM-Agent** option will be visible to user, else **AK-EM 800** option is visible to user. Only one option will appear at a time (that is easy to understand).

The disk space mentioned above is the minimum available disk space required to install the application successfully. Recommended free hard disk space for AKM-Agent software to function properly is 5 GB.

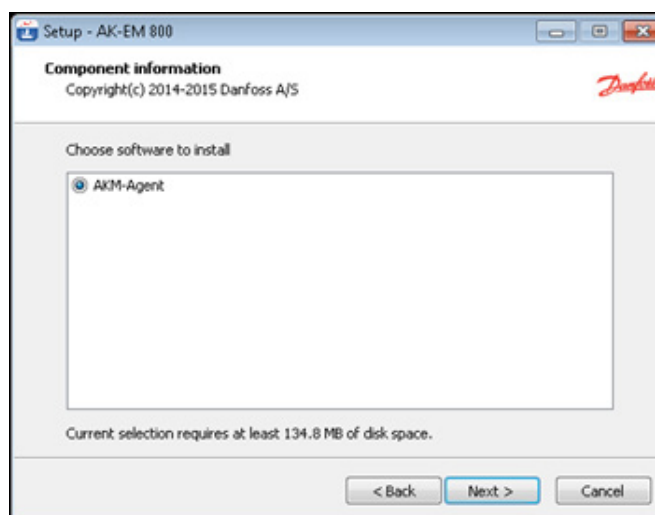

After clicking on “Next” button the below screen will appear where user can select language for the application to get started (default language is English).To continue, click on “Next”.

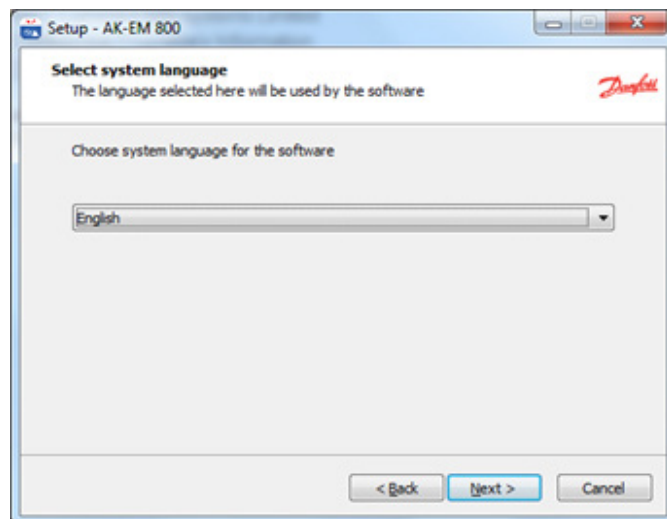

The directory in which the application is to be installed will be asked to the user as shown in the following screen shot. User can select the directory of his choice. Click “Next” to continue.

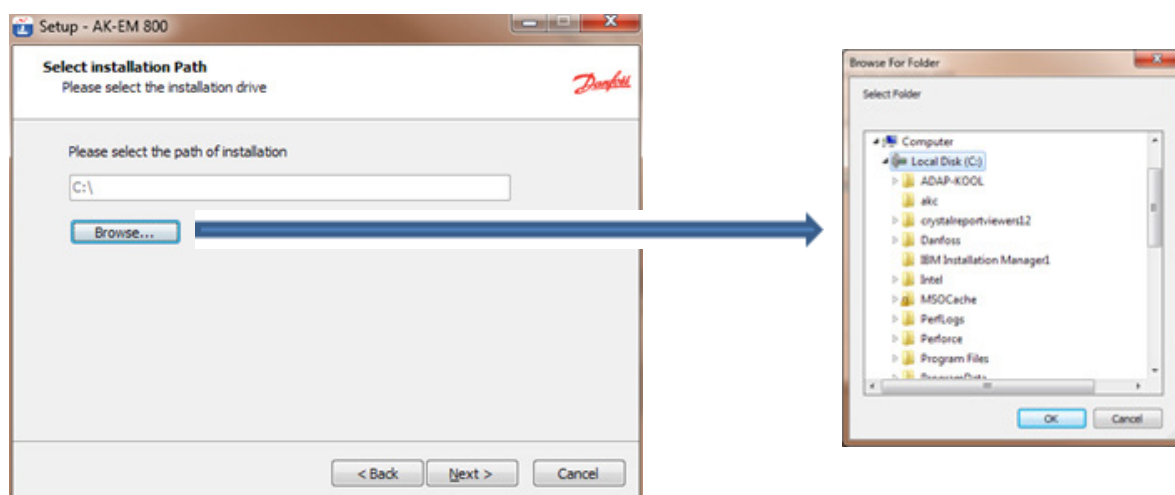

Here, user can select additional tasks to perform (like creation of shortcut on desktop and start menu) from the list as shown by the below screen:

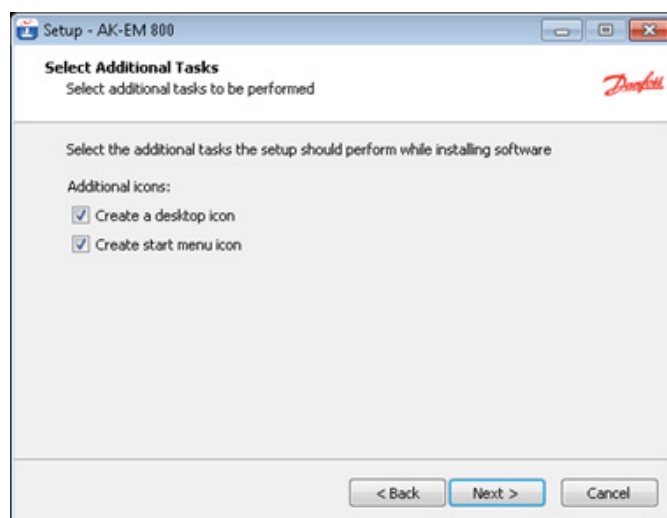

Click on “Next” to continue or to change settings user can click on “Back”.

Click on 'Install' button to continue with the installation.

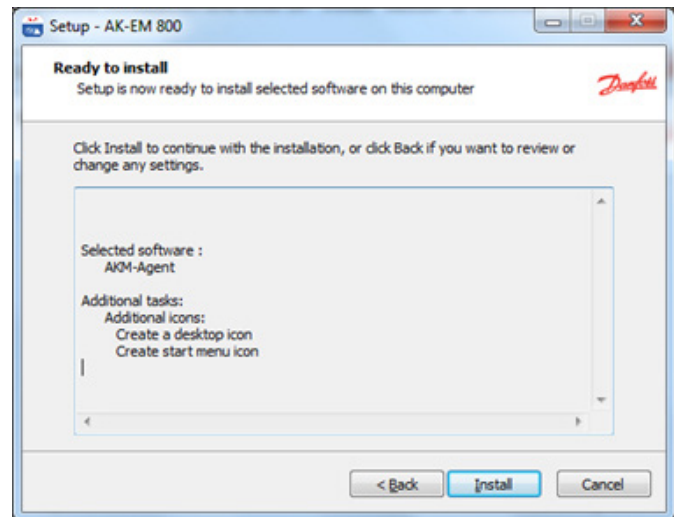

Please wait until the installation process is completed. During this step installer will extract and install all the required software in background.

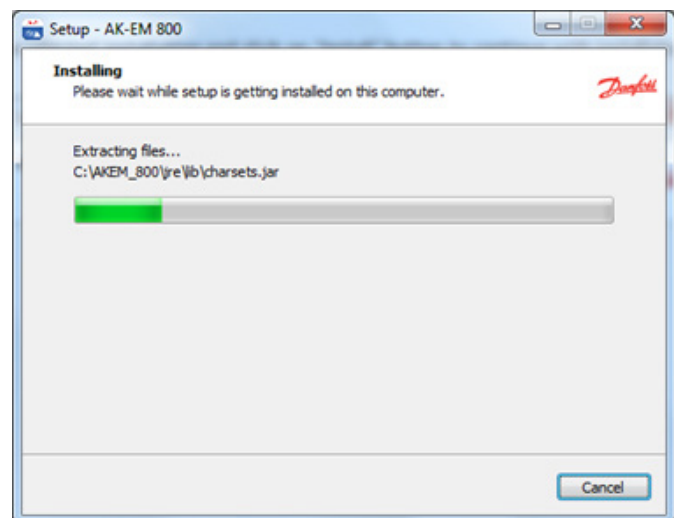

The below is the completion screen of installation. User can select options provided on the below screen to see the status of installation and/or to launch the application. Click on 'Finish' button to complete installation. If the user does not wish to launch EM800 and/or see the status file, he can uncheck the option accordingly.

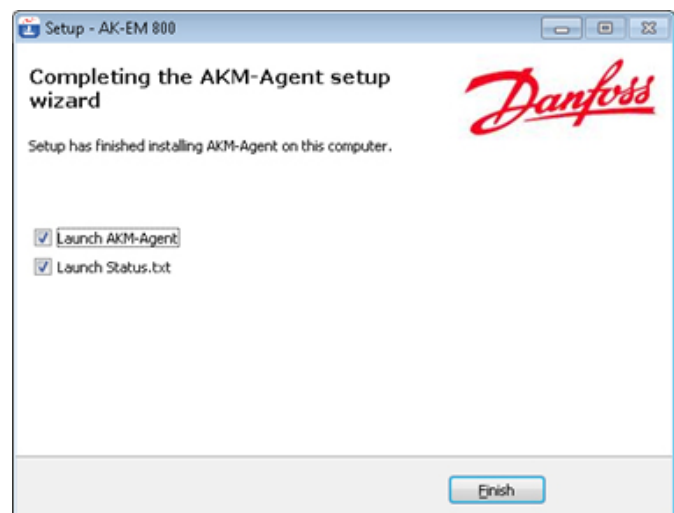

Note: On some servers, the IP Address of the host may not be retrieved successfully into the status file by the installer. This could be because of the different network configurations (DHCP/DNS, IPv6 etc) on some servers. This will not create any problems in the functioning of AKM-Agent.

The installation of the AKM agent is similar to the installation of the AK-EM 800, but the agent can run only on a 32bit system, because AKM supports only 32bit systems. The agent requires AKM and cannot run together with the AK-EM 800 on the same computer. The AKM agent installation creates a Desktop icon. Use the icon or type in your browser

<http://localhost:8080/AKMAgent>. Password is **danfoss**

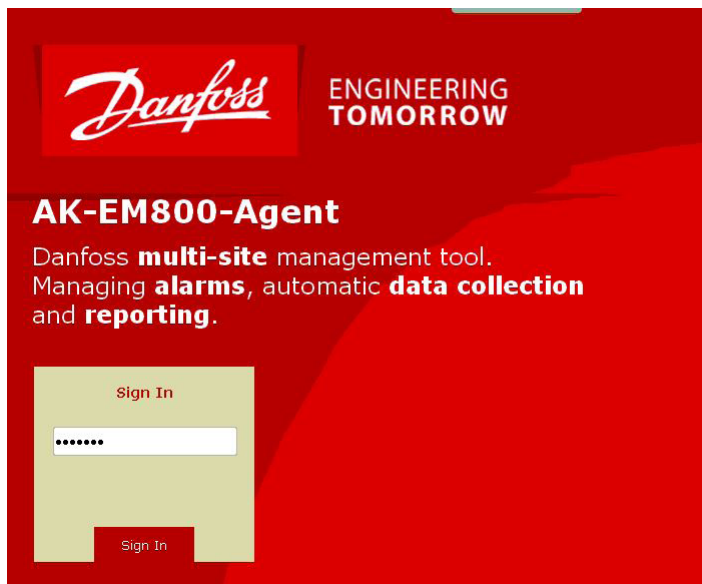

If the user wants to change the default password (danfoss) to a user defined one, it can be done in the "My Settings" page.

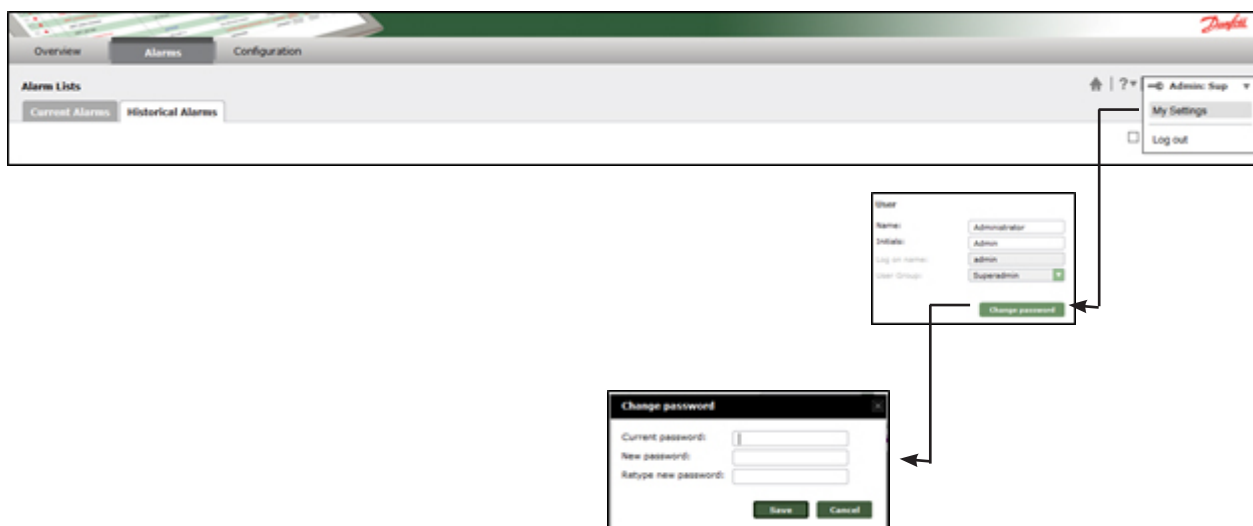

The AKM Agent needs to be configured with information about where to send the alarms. This is done in the Setup function – Communication page

Once all settings are done press the **Save** button.

When saving the settings AKM Agent will try to communicate with the AK-EM 800 system and give one of the below shown messages.

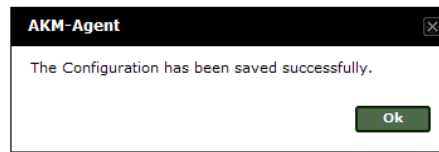

If the connection details are wrong or AKM is not started an error message will be displayed and the settings will not be saved

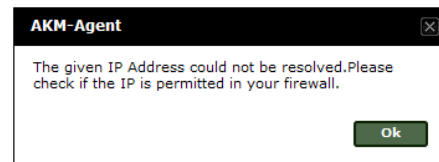

Attention!

The test button is only testing the connectivity between Agent and AK-EM 800 and not, if alarms via port 3001 (or different if chosen) can be handled.

When the Agent is configured correctly, the sites defined to be monitored in the AK-EM 800 system will be listed in the System managers page.

The alarms will be forwarded to the AK-EM 800 system automatically.

Log data is collected by request from the AK-EM 800 system.

Site ID	Network address	Network name	Network type	Supported data
1	-1:-1:-1	Unknown Site	null = *	ALARMS
2	000:000:000:125	Panel GW	AK1SM = AKA	LOGSALARMS
4	1:0:0	PKS SM350	AK2SM	LOGSALARMS
3	1:0:1	PKSs SM720	AK2SM = SM	LOGSALARMS
8	2:0:0	SC 255 @ E4-189 South	AKSC	LOGSALARMS

*System alarms

System upgrade

The upgrade is very similar to the installation. Difference is, that the setup detects an existing database / application and notes that on the display.

The start screens are the same. The difference comes in one of the 1st steps

Please read the license agreement

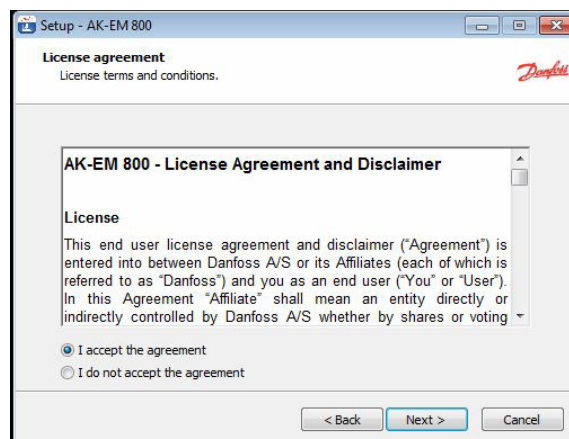

Accept the agreement and choose next.

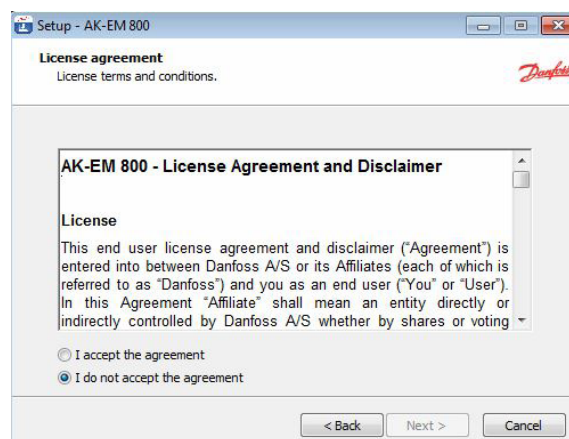

In case of an upgrade, the installation process will inform the user about the version change.

Important !

If the update is replacing a version below version 2.0 a license is required. After the upgrade it is NOT possible to use EM800 until the license is inserted.

How to get a license is described in the EM800 manual.

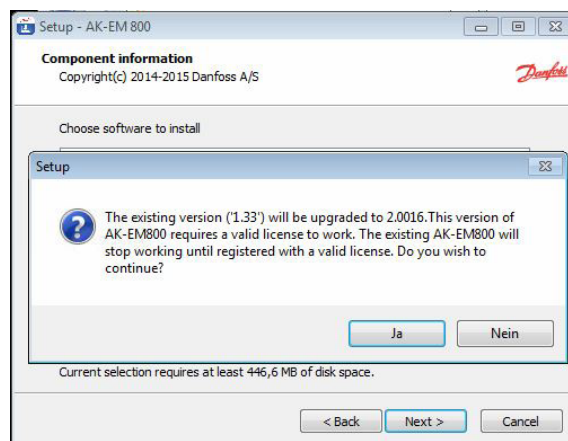

Upgrade AK-EM 800

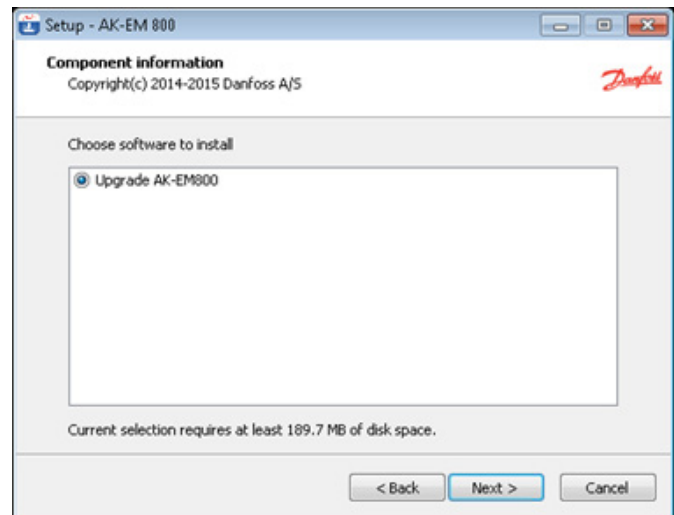

Upgrade AKM Agent

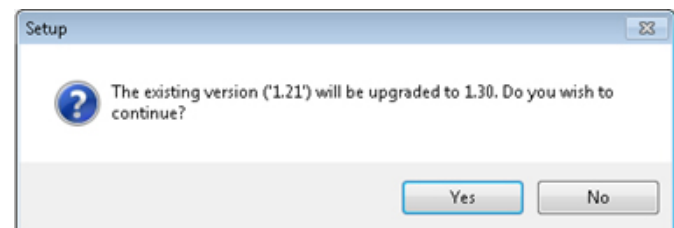
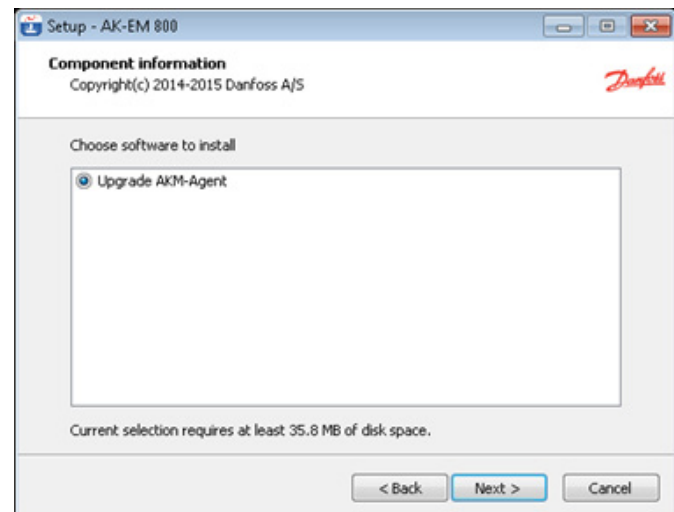

Starting or restarting TOMCAT (optional or after upgrade from Version 1.xx to 2.0)

Tomcat will be automatically started at the time of installation. If tomcat is already running then user can skip this section. Go to “Control Panel” → “Administrative Tools” → double click on “Services”; a window like below shall be shown to the user:

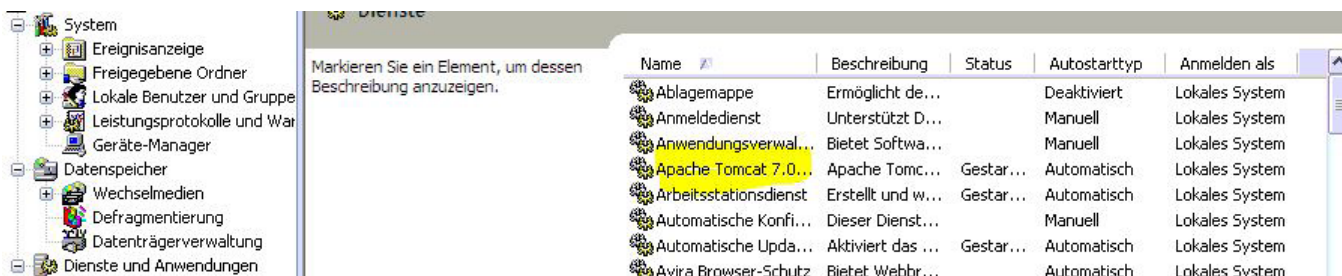

Select Apache Tomcat6 → double click on that, a dialog as shown below shall appear to the user

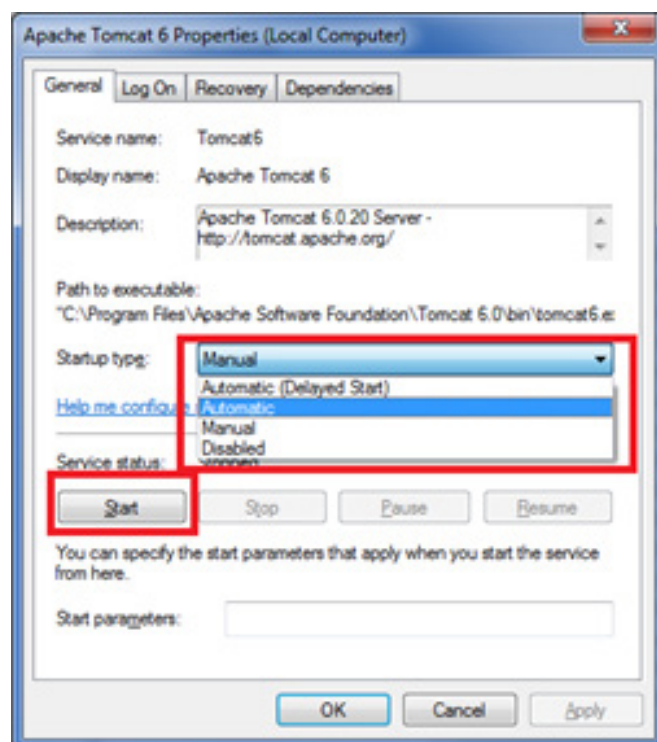

Select Automatic as shown in the above dialog and click on “Start” button → Click on “OK” button.

Setting up the memory of TOMCAT (optional)

Navigate to the install path of the AK EM-800 ..\AKEM_800\server\bin

Change the setting of the Maximum memory pool to the following

Gigabytes Allocated	Maximum Memory pool setting
1	1024
2	2048
3	3072
4	4096
5	5120
6	6144
7	7168
8	8192
9	9216
10	10240
11	11264
12	12288
13	13312
14	14336
15	15360
16	16384

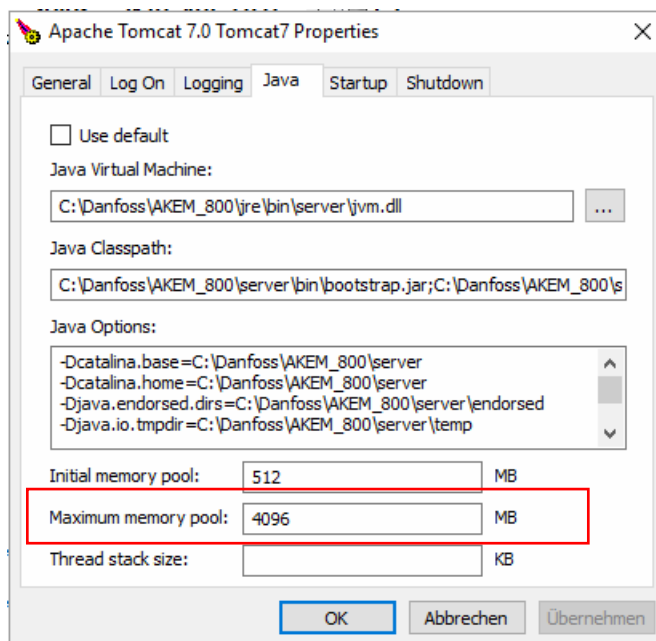

Go to the tab "Java" as shown above and set the value as shown above.

Click on "Apply" button then press "OK" button.

Now the setup is done.

Uninstall AK-EM 800 (optional)

Note: Close the browser and other applications using JRE before uninstalling AK-EM 800. This section explains how to uninstall the applications.

Select Control Panel from start menu :

AK-EM 800

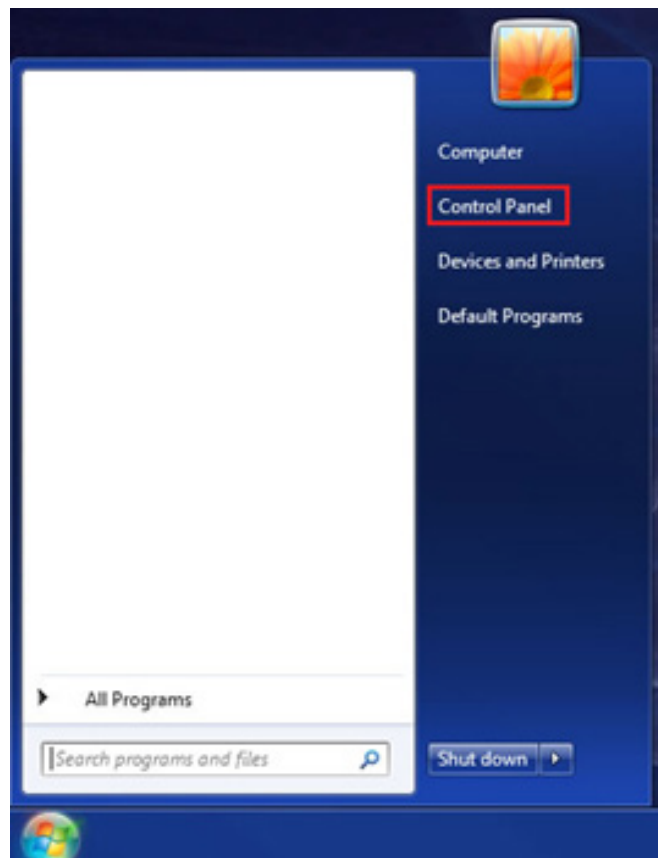

Following window will appear. Select "Uninstall a program" option under "Programs" category

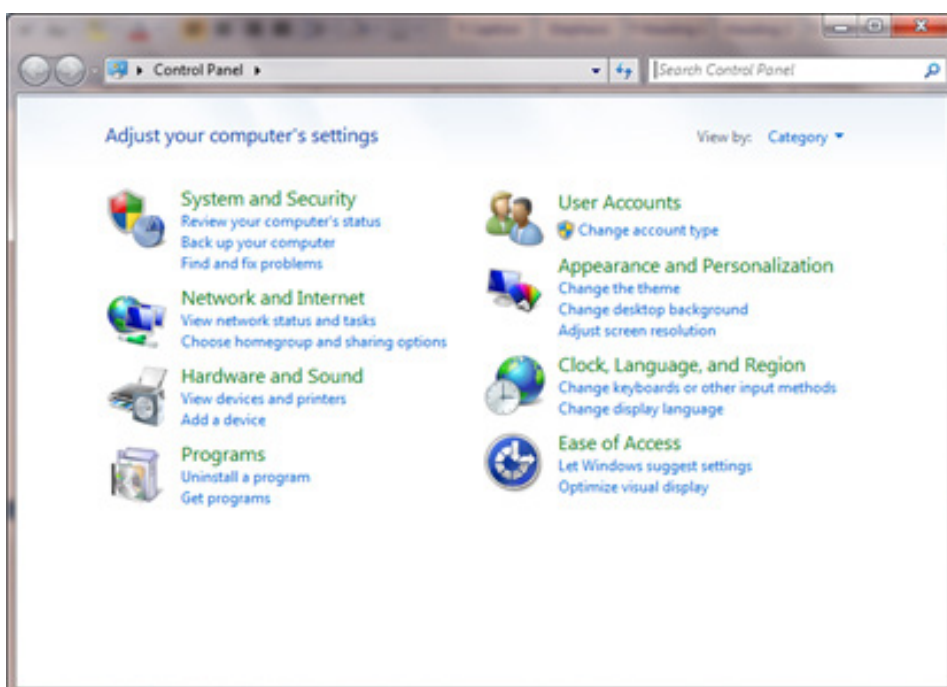

Following window will appear. Right click on AK-EM 800 and select “Uninstall” option.

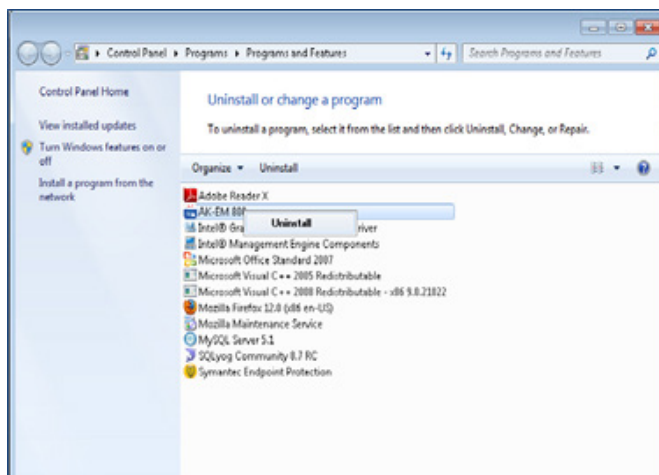

Following screen will appear. Select “Yes” to continue to uninstall AK-EM 800, else select “No”.

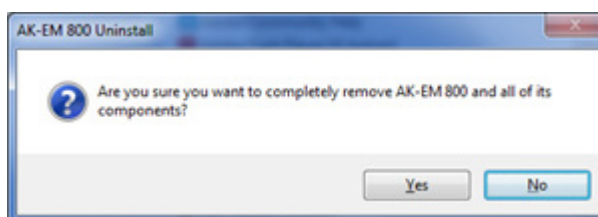

After clicking on “Yes” it will uninstall AK-EM 800 and after the successful uninstallation following window will be shown to the user.

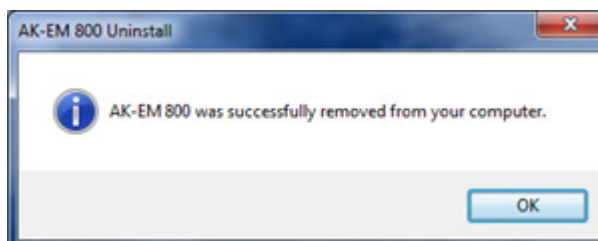

Uninstall AKM Agent (optional)

Note: Close browser and other application using JRE before uninstalling AKM-Agent

Select Control Panel from start menu :

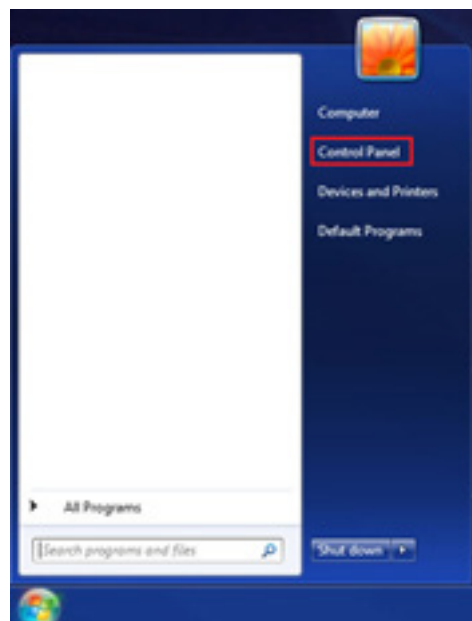

Following window will appear. Select "Uninstall a program" option under "Programs" category.

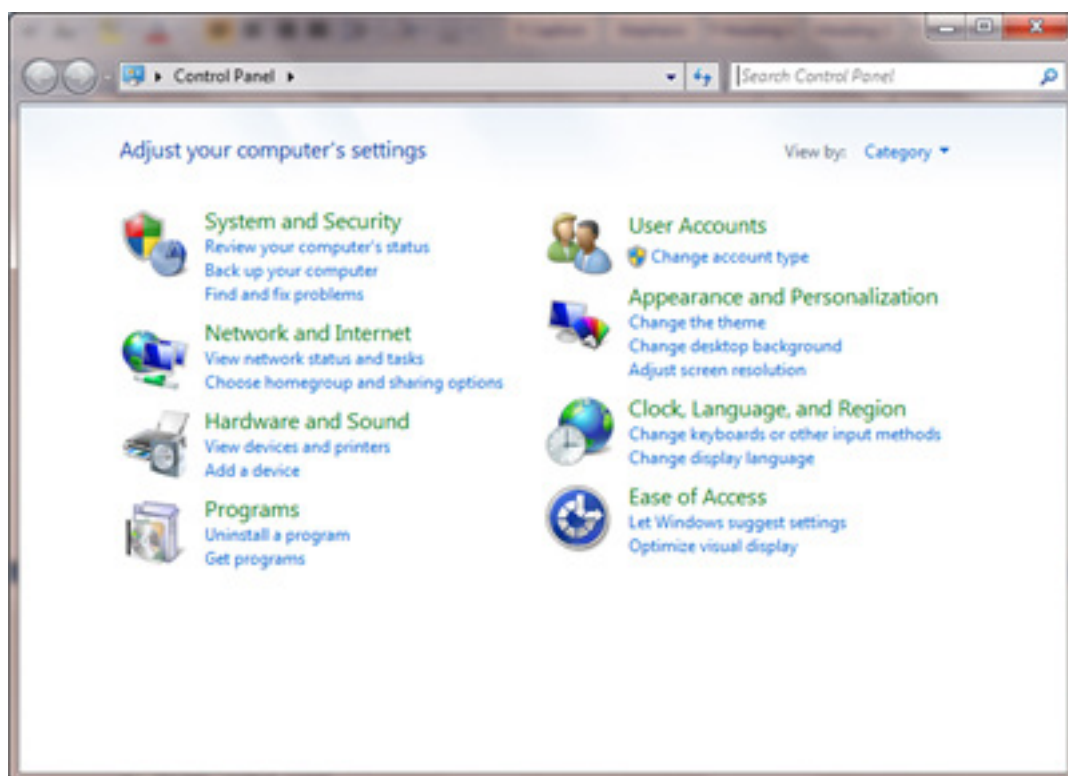

Following window will appear. Right click on AKM-Agent and select "Uninstall" option.

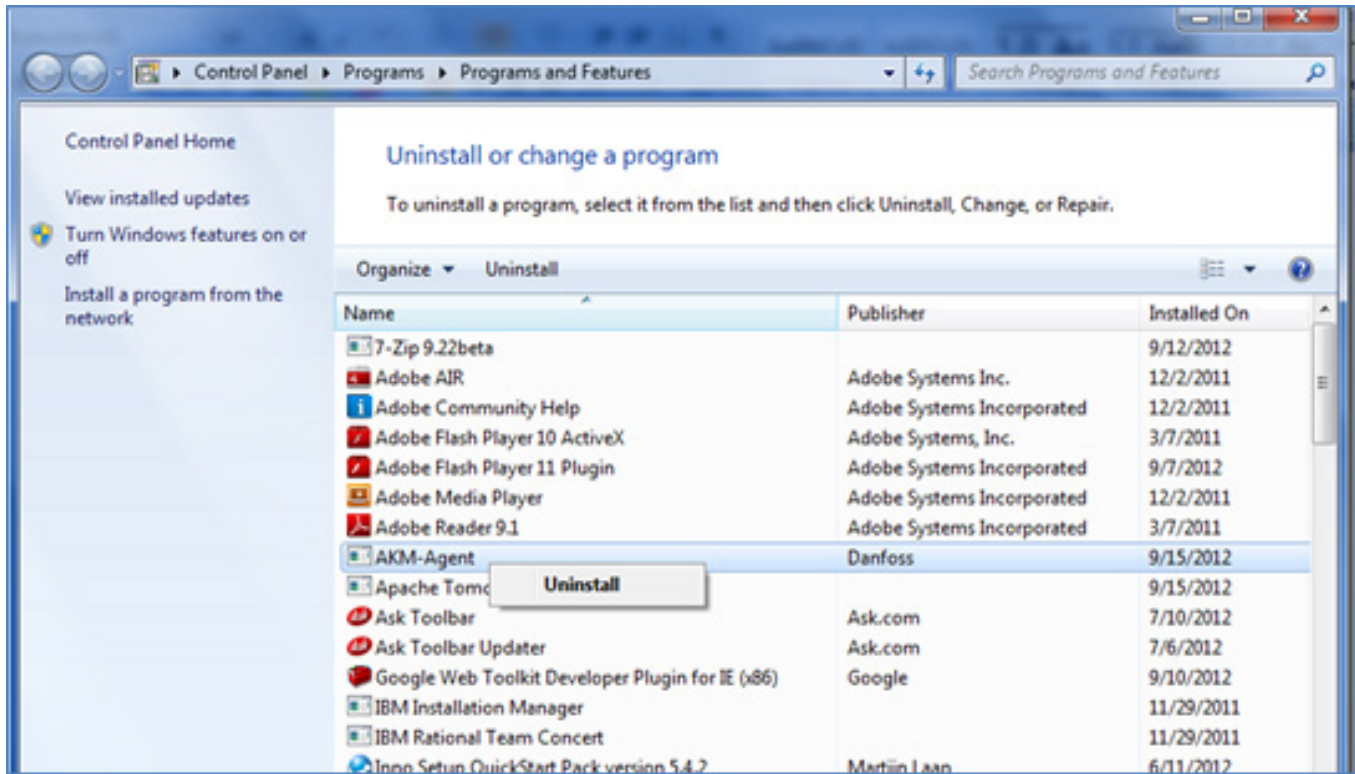

Following screen will appear. Select "Yes" to continue to uninstall AK-EM 800, else select "No".

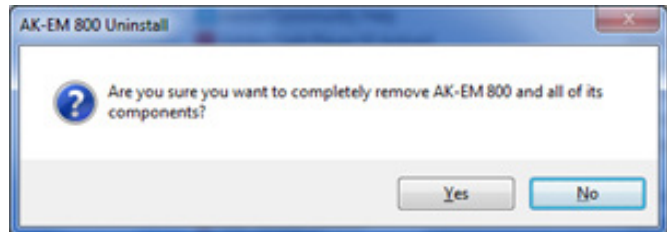

Confirmation screen for uninstall AKM-Agent

After clicking on "Yes" it will uninstall AK-EM 800 and after the successful uninstallation following window will be shown to the user.

