

Data sheet

CI-TI™ Contactors and motor starters

Types CI 61 - CI 98

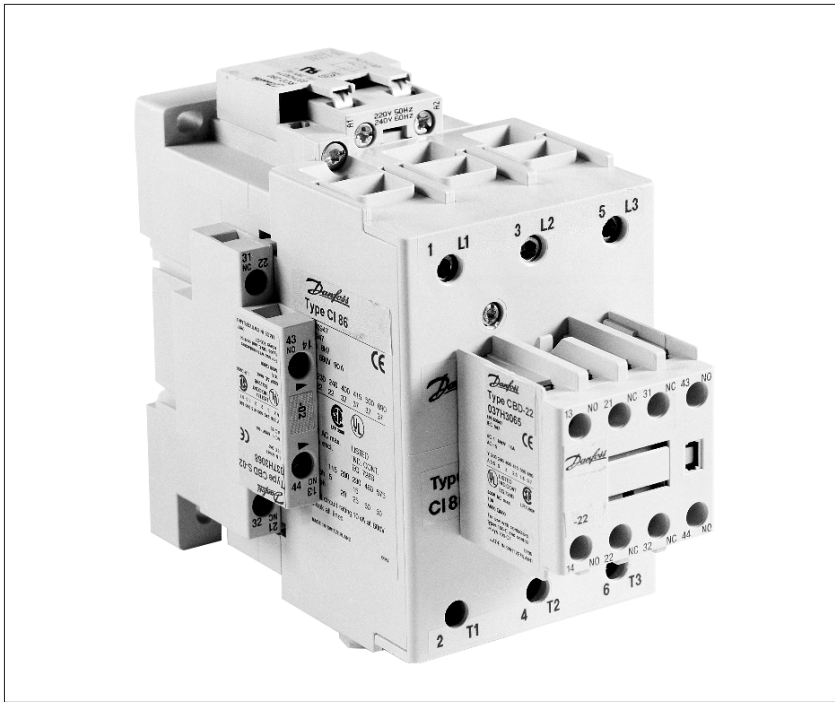

Contactors CI 61, CI 73, CI 86 and CI 98 switch powers of up to 30 kW, 37 kW, 45 kW and 55 kW respectively under 3×380 V AC-3 loads.

Accessories include a wide selection of auxiliary contacts, mechanical interlocks and RC elements. Auxiliary contacts for mounting on the side or top are available. The auxiliary contacts have force-actuated contacts and can form part of safety switching.

Ordering
Contactors CI 61, CI 73, CI 86, CI 98

Type	Main circuit					Main contacts (make)	Add-on options	Code no. ¹⁾
	AC-3 load			I _{th} ²⁾ (AC-1) Open	I _{the} ³⁾ (AC-1) Encl.			
	U _e 220 – 240 V	U _e 380 – 690 V	I _e					
	[kW]	[kW]	[A]	[A]	[A]			
CI 61	18.5	30	60	100	100	3	1-8	037H3061
CI 73	22	37	72	100	100	3	1-8	037H3062
CI 86	25	45	85	100	100	3	1-8	037H3063
CI 98	30	55	97	130	110	3	1-8	037H3040

¹⁾ Coil voltage / frequency or Suffix no. (see table below) must be added to the Danfoss code no.

²⁾ The thermal current I_{th} gives the maximum load at 40 °C, which corresponds to installing the contactor in air (open).

³⁾ The thermal current I_{the} gives the maximum load at 60 °C, which corresponds to installing the contactor in an enclosure.

Coil voltages and coils for CI 61, CI 73, CI 86, C 98

Coil voltage ¹⁾ - (suffix no.)		24 V 50/60 Hz	110 V, 50/60 Hz	220 – 230 V, 50/60 Hz	380 – 400 V, 50/60 Hz
Contactor	Code no.	(13)	(23)	(32)	(39)
CI 61	037H3061	■	■	■	■
CI 73	037H3062	■	■	■	□
CI 86	037H3063	■	■	■	■
CI 98	037H3040	-	-	■	■

 Available ■
 Special order □
 Unavailable -

CBD 11

CBD 22

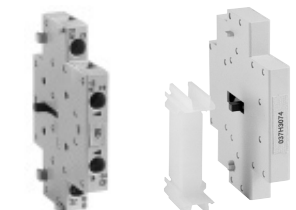

BD S-

Mechanical interlock

Auxiliary contact block CBD for CI 61, CI 73, CI 86 and CI 98 contactors

Type	Contact function ¹⁾	Load				Code no.
		I _e (AC-15)	I _{th} ²⁾ (AC-1) Open	I _{the} ³⁾ (AC-1) Encl.	U _e	
		[A]	[A]	[A]	[V]	
CBD-11	1 make (NO) + 1 break (NC)	5.5	10	6	690	037H3064
CBD-22	2 make (NO) + 2 break (NC)	5.5	10	6	690	037H3065
CBD S-NC	1 break (NC)	3	10	6	690	037H3066
CBD S-NO	1 make (NO)	3	10	6	690	037H3067
CBD S-11	1 make (NO) + 1 break (NC)	3	10	6	690	037H3069
CBD S-20	2 make (NO)	3	10	6	690	037H3070

¹⁾ Force-actuated contacts suitable for safety switching.

²⁾ The thermal current I_{th} gives the maximum load at 40 °C, which corresponds to installing the contactor in air (open).

³⁾ The thermal current I_{the} gives the maximum load at 60 °C, which corresponds to installing the contactor in an enclosure.

 In CBD auxiliary contact the silver tips are cross-stamped.
 In CBD S auxiliary contact the silver tips are H-shaped.

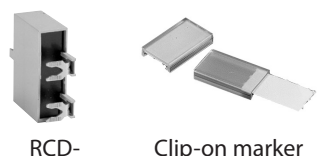
 Both contact types are PLC-compatible.
 Min. load 24 V, 10 mA.

RCD-

Clip-on marker

Accessories for contactors CI 61, CI 73, CI 86, CI 98

Description	Comments	Code no.
Mech. interlock	Mech. interlock can be established between pairs	037H3074
	Type RCD 280 (110 – 280 V, 50/60 Hz)	037H3072
Clip-on markers	Rating plate with cover	037H3142

Description

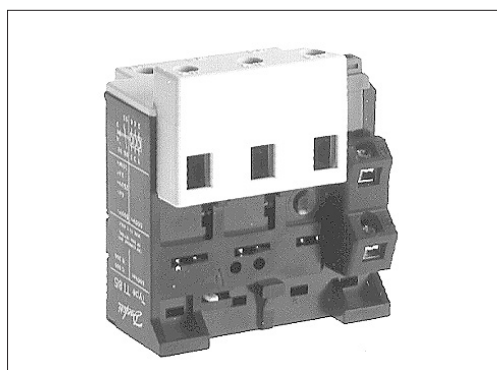

Thermal overload relays TI 80 - TI 86 are used with contactors type CI 61, CI 73 and CI 86 to give overload protection of squirrel-cage motors of 30 – 55 kW. The relays trip under asymmetric load, i.e. accelerated release if phase drop-out occurs.

Other features of TI 80 and TI 86:

- stop / reset button
- manual / automatic reset
- test button
- double scale for direct start or Y / D start
- signal contact with changeover

Ordering

Thermal overload relays TI 80 and TI 86

Type	Range		Max. fuse ¹⁾		Code no.
	Motor starter	Y / D starter	gI, gL, gG Type 2	BS 88, type T Type 2	
	[A]	[A]	[A]	[A]	
TI 80	42 – 63	75 – 109	100	100	047H1016
TI 80	60 – 80	105 – 138	125	125	047H1017
TI 86	74 – 85	130 – 147	125	125	047H1018

¹⁾ To IEC 947-4 coordination types 1 and 2:

Coordination type 1: Any type of damage to the motor starter is permissible. If the motor starter is in an enclosure, no external damage to the enclosure is permissible. After a short-circuit the thermal overload relay shall be partially or wholly replaced.

Coordination type 2: No damage to the motor starter is permissible, but slight contact burning and welding is permissible.

Selection of thermal overload relay

The selection of a thermal overload relay must be based on the motor full load current and the method of starting:

- With direct start the motor starter range applies
- With star-delta start Y / D starter range applies

Example:

Full load current: 85 A

- With direct start, the suitable motor starter range is 74 – 85 A, i.e. thermal overload relay **047H1018**
- With star-delta start, the suitable Y/D starter range is 75 – 109 A, i.e. thermal overload relay **047H1016**

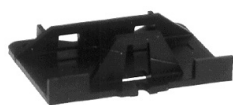

Base



Push button extension



Current rail set

Accessories for thermal overload relays TI 80 - TI 86

Description	Comments	Code no.
Clip-on markers	For mounting on TI 80 - TI 86 (250-off)	037H010566
Base	For separate mounting of TI 80 - TI 86	047L045666
Pushbutton extension	For TI 9C TI- TI 86 (3 mm)	047L040666
Current rail set	For direct mounting of TI 80 / TI 86 on contactors CI 61-73-86 (set of 3)	037H010866

Data sheet | CI-TI™ Contactors and motor starters, Types CI 61 - CI 98

Construction standards

- Contactors, thermal overload relays and accessories are designed and tested in accordance with IEC 947/EN 60947.
- Environment
- Temperate climate
- Tested and passed in accordance with DIN 50 016 and 40 046 part 38 and IEC 68
- Max. installation height: 2000 NN, in accordance with IEC 947

Pulse voltage

Type	U _{imp}
CI 61-CI 73-CI 86-CI 98	8 kV

Ambient temperature

Type	Ambient temperature	
	Operation	Storage / Transport
CI 61-CI 73-CI 86-CI 98	-25 °C – 60 °C	-55 °C – 80 °C

Environment

Type	Temperature compensated	Ambient temperature	Vibration	Shock perpendicular to contact system	Max. operations per hour
TI 86	-5 – 40 °C	-50 – 60 °C	2 g at 200 Hz	9 g for 7.5 ms	30

Mounting direction

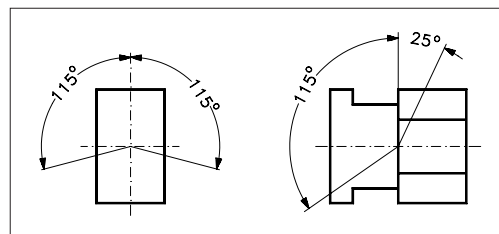

Approvals

Type	EN 60947	c US LISTED	EAC	LLC CDC TYSK
CI 61	•	•	•	•
CI 73	•	•	•	•
CI 86	•	•	•	•
CI 98	•	•	•	•
TI 80	•	•	•	•
TI 86	•	•	•	•

• Approved

Rated life

Type	Mechanical life Operations	Electrical life AC-3 Operations	Duty cycles per hour AC-3 load Operations
CI 61-CI 73-CI 86-CI 98	10 x 10 ⁶	1 x 10 ⁶	300

Electrical life curves

Contactors CI 61-73-86-98 load categories, AC-1

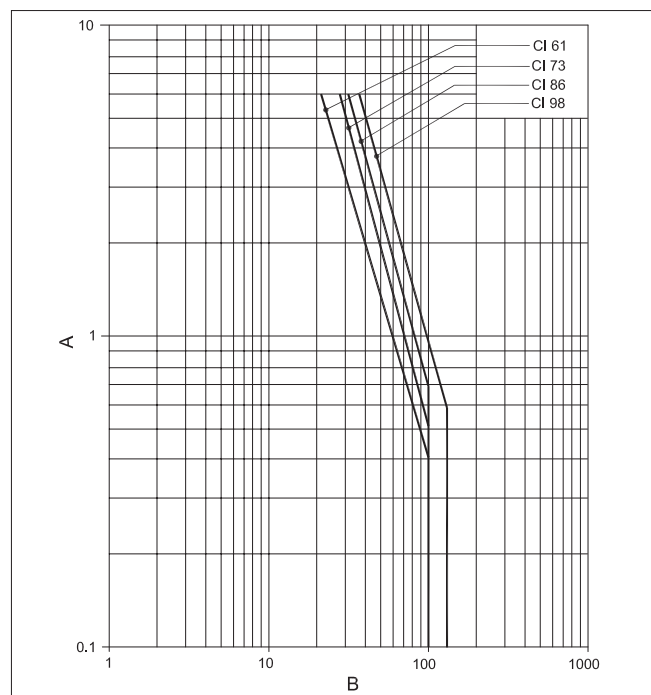

Contactors CI 61-73-86-98, load categories AC-3 & AC4
10% AC-4 Mixed operation of squirrel-cage motors;
 $U_e = 230...400...460\text{ V}$

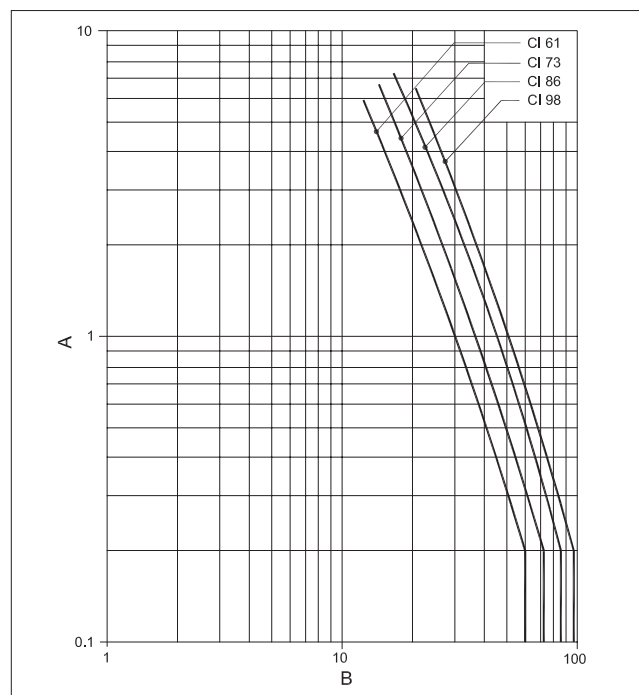

Contactors CI 61-73-86-98, load categories AC-4
Switching of squirrel-cage motors; $U_e = 230...690\text{ V}$

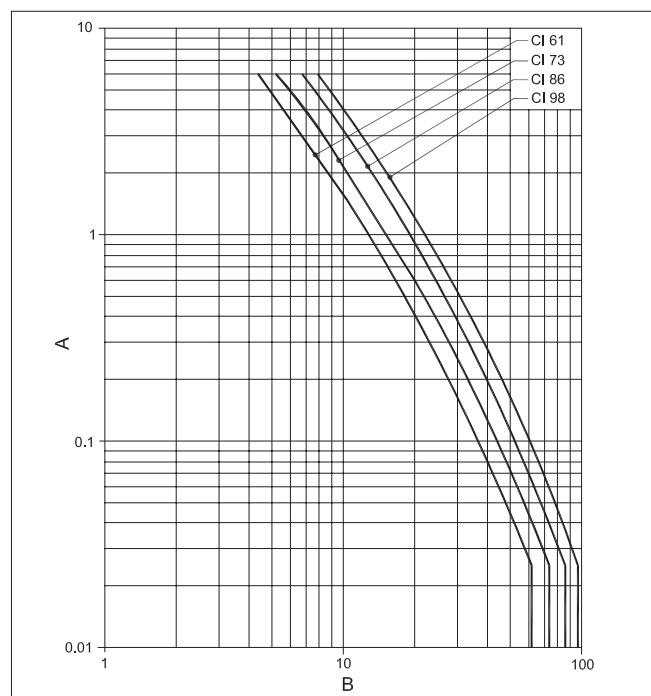

Contactors CI 61-73-86-98, load categories AC-3
Switching of squirrel-cage motors while starting;
 $U_e = 230...400...460\text{ V}$

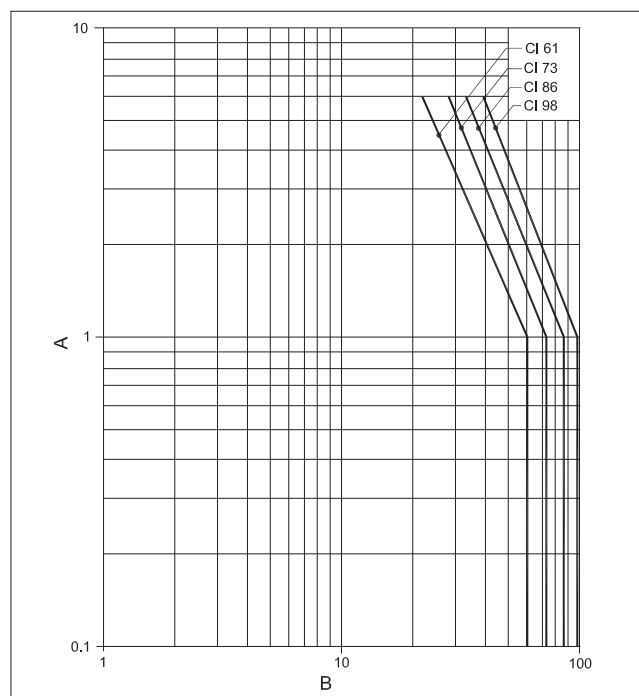

A: Electrical life in millions of make / break operations.
B: Rated Operating current (A).

Tripping graphs

TI 80 / 86

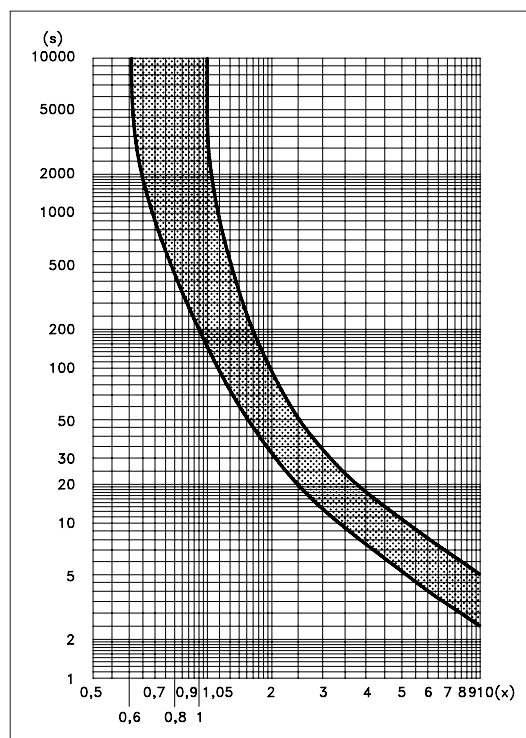

Explanation of graphs

Mean value curves

Upper curve: 3-phase tripping and asymmetric load tripping at min. setting

Lower curve: Asymmetric load tripping at max. setting

When tripping from the operationally warm condition, the tripping times are approx. 30% of the values shown. These values apply at an ambient temperature = 20 °C.

$$\text{3-phase tripping: } x = \frac{\text{measured current}}{\text{rated motor current}}$$

$$\text{Asymmetric load tripping: } x = \frac{\text{measured current}}{\text{max. scale value on overload relay}}$$

Tripping time $2 < T_p \leq 10$ s at $7.2 \times I_e$ class 10 A

Note! In general, the thermal overload relay is always set on motor full load current.

3-phase overload

1. Measure overload current
2. Find the overload factor (x) by dividing the measured value by the set value of the thermal overload relay (motor full load current).
3. Find (x) on the horizontal axis and follow a line vertically up until it intersects the upper curve.
4. From the intersection point, follow a horizontal line to the left and read off on the vertical axis the time that will elapse before the thermal overload relay cuts out the motor.

Asymmetric load tripping

1. Measure the current the motor draws from one of the intact phases.
2. Find the overload factor (x) by dividing the measured value by the maximum scale value of the thermal overload relay.
3. Find (x) on the horizontal axis and follow a line vertically up until it intersects the lower curve.
4. From the intersection point, follow a horizontal line to the left and read off on the vertical axis the time that will elapse before the thermal overload relay switch off the motor.

Contact symbols and terminal marking

Auxiliary contacts

<p>Auxiliary contacts CBD - 11</p>	<p>Auxiliary contacts CBD - 22</p>
<p>Auxiliary contacts CBD S - NO</p>	
<p>Auxiliary contacts CBD S - NC</p>	
<p>Auxiliary contacts CBD S - 11</p>	
<p>Auxiliary contacts CBD S - 20</p>	

Contactors and thermal overload relay

<p>Contactors CI 61/73/86/98</p>	<p>Thermal overload relay TI 80/86</p>
--------------------------------------	--------------------------------------------

Connections
Connections, main contacts and contactor coils

Type	Connection method	EN 60947			Tightening torque [Nm]
		Single	Multicore		
			Without terminal sleeve	With terminal sleeve	
[mm ²]	[mm ²]	[mm ²]	[mm ²]		
CI 61, CI 73, CI 86, CI 98	Screw and box terminal	2.5 – 50	2.5 – 35	–	2 – 6
TI 80, TI 86	Screw and box terminal	1.5 – 35	1.5 – 25	–	0.8 – 3 – 5
Coil	Screw and clamp washer	0.52 – 2.5	0.5 – 2.5	0.5 – 2.5	1 – 1.5

Loads
Direct start, load categories AC-2, AC-3, AC-4

Type	Switching of 3-phase Motors; (50 Hz); Ambient temperature 60 °C, AC-2, AC-3, AC-4						
	Rated loads at 50 Hz						
		220 – 230 V	240 V	380 – 400 V	415 V	500 V	690 V
CI 61	A	62	62	60	60	55	34
	kW	18.5	18.5	32	32	37	32
CI 73	A	72	72	72	72	67	42
	kW	22	22	40	40	45	40
CI 86	A	85	85	85	85	80	49
	kW	25	25	45	45	55	45
CI 98	A	96	95	97	97	78	57
	kW	30	30	55	55	55	55

Star-delta start, load category AC-3

Type	Star-delta start, load category AC-3						
	Rated Loads at 50 Hz						
		220 – 230 V	240 V	380 – 400 V	415 V	500 V	690 V
CI 61	A	107	107	104	104	95	59
	kW	32	32	55	55	63	55
CI 73	A	125	125	125	125	116	73
	kW	37	40	63	63	80	63
CI 86	A	147	147	147	147	139	85
	kW	45	50	80	80	90	80
CI 98	A	166	165	168	168	135	99
	kW	50	50	90	90	90	90

Three-phase ohmic load, load category AC-1

Type	AC-1 Active Power Load (50 Hz)						
	Operating temperatur max. 40 °C (open condition) Heat-resistant cable only (min 75 °C)						
		220 – 230 V	240 V	380 – 400 V	415 V	500 V	690 V
CI 61, CI 73, CI 86	A	100	100	100	100	100	100
	kW	40	42	69	2	87	120
CI 98	A	130	130	130	130	130	130
	kW	52	54	90	93	113	155

Three-phase ohmic load, load category AC-1

Type	AC-1 Active Power Load (50 Hz)						
	Operating temperatur max. 60 °C (encl. condition) Heat-resistant cable only (min 75 °C)						
		220 – 230 V	240 V	380 – 400 V	415 V	500 V	690 V
CI 61, CI 73, CI 86	A	100	100	100	100	100	100
	kW	40	42	69	72	87	120
CI 98	A	110	110	110	110	110	110
	kW	44	46	76	79	95	131

Switching three-phase power transformers (AC-6a)

Type	Switching of Power Transformers; AC-6a (50 Hz)						
	Transformer load, (factor n = 30, inrush current = n x rated transformer current)						
		220 – 230 V	240 V	380 – 400 V	415 V	500 V	690 V
CI 61	A	40.8	40.8	40.8	40.8	40.8	40.8
	kW	16	17	28	29	35	49
CI 73	A	40.8	40.8	40.8	40.8	40.8	40.8
	kW	16	17	28	29	35	49
CI 86	A	40.8	40.8	40.8	40.8	40.8	40.8
	kW	16	17	28	29	35	49
CI 98	A	48.5	48.5	48.5	48.5	48.5	48.5
	kW	19.3	20.2	33.6	34.9	42	58

Technical data
Switching lighting

Type	Incandescent lamps (AC-5b) Max. operating current [A]	Fluorescent lamps, individually compensated (AC-5b)				
		Max. operating current [A] at operating temperature ¹⁾		Max. Capacity [uF] at Icc=		
		40 °C	60 °C	10 kA	20 kA	50 kA
CI 61	60	81	77	4000	2000	800
CI 73	70	85	81	4000	2000	800
CI 86	76	90	90	4700	2350	940
CI 98	90	115	100	4700	2350	940

Switching capacitor loads, individual capacitors (AC-6b)
Inductance in leads between capacitors connected in parallel min. 6µH

Type	Max. Reactive power [kVAR] ¹⁾							
	220 – 240 V		380 – 415 V		500 V		690 V	
	40 °C	60 °C	40 °C	60 °C	40 °C	60 °C	40 °C	60 °C
CI 61	28	28	48	42	50	42	50	42
CI 73	28	28	48	48	55	50	55	50
CI 86	28	28	48	48	60	55	60	55
CI 98	28	28	48	48	60	55	60	55

Switching capacitor loads, regulating capacitors (AC-6b)
Inductance in leads between parallel-connected capacitors must be min.6µH

Type	Max. Reactive power [kVAR] ¹⁾							
	220 – 240 V		380 – 415 V		500 V		690 V	
	40 °C	60 °C	40 °C	60 °C	40 °C	60 °C	40 °C	60 °C
CI 61	28	28	40	40	50	40	40	40
CI 73	28	28	48	48	50	50	50	50
CI 86	28	28	48	48	50	50	50	50
CI 98	28	28	48	48	50	50	50	50

Switching direct current load at 60 °C ambient temperature
Load categories DC-3 and DC-5, contacts connected in series

Type	Max. operating current [A]									
	DC-3. 3 poles in series					DC-5. 3 poles in series				
	24 V	48 V	110 V	220 V	440 V	24 V	48 V	110 V	220 V	440 V
CI 61	90	70	70	25	0.6	90	70	70	25	0.6
CI 73	90	70	70	25	0.6	90	70	70	25	0.6
CI 86	100	80	80	30	0.6	100	80	80	30	0.6
CI 98	100	80	80	30	0.6	100	80	80	30	0.6

Switching direct current load at 60 °C ambient temperature
Load category C-1, contacts connected in series

Type	Max. operating current [A]														
	24 V			48 V			110			220 V			440 V		
	1 pole	2 poles	3 poles	1 pole	2 poles	3 poles	1 pole	2 poles	3 poles	1 pole	2 poles	3 poles	1 pole	2 poles	3 poles
CI 61	70	70	90	40	70	90	11	70	90	2	15	70	0.5	1.5	5
CI 73	80	80	90	40	80	90	11	80	90	2	15	80	0.5	1.5	5
CI 86	80	80	100	40	80	100	11	80	100	2	15	80	0.5	1.5	5
CI 98	80	80	100	40	80	100	11	80	100	2	15	80	0.5	1.5	5

Contact resistance and power loss

Type	Typical impedance per pole [mΩ]	Power loss at 3 poles	Coil consumption AC [W]	Total power loss
		AC-3 [W]		AC-1 [W]
CI 61	0.9	9.7	4.5	14.2
CI 73	0.9	14	4.5	18.5
CI 86	0.9	19.5	4.5	24
CI 98	0.6	17	9	26

Short-time withstand current I_{cw}

Type	Current transfer time 10 sec.	Min cooling Time [min.]
	Short time withstand current in Amps (I _{cw})	
CI 61	700	20
CI 73	700	20
CI 86	700	20
CI 98	840	20

¹⁾ 40 °C is defined as non-enclosed installation.
60 °C is defined as enclosed installation.

Technical data (continued)
Connections, auxiliary contacts

Type	Connection method	Single and multi core [mm ²]	High capacity		Tightening torque [Nm]
			without term. sleeve [mm ²]	with term. sleeve [mm ²]	
			CBD-, CBD S- For CI 61- CI 73 - CI 86- CI 98	Screw and clamp washer	
TI 80, TI 86	Screw and clamp washer	0.75 – 2.5	0.75 – 1.5	0.5 – 1.5	0.3 – 1

Auxiliary contacts, load categories AC-15 and AC-1

Type	Comments	Max. operating current [A]							
		AC-15				AC-1			
		220 – 230 V	240 V	380 – 400 V	415 V	500 V	690 V	40 °C ¹⁾	60 °C ¹⁾
CBD-	For contactors CI 61- CI 73 - CI 86 - CI 98	5.5	5	3	2.5	1.6	1	10	6
CBD S-		3	3	2	2	1.6	0.75	10	6

¹⁾ 40 °C is defined as non-enclosed installation.
60 °C is defined as enclosed installation.

Auxiliary contacts, load categories DC-12, DC-13, and DC-14

Type	Comments	Max. operating current [A]														
		DC-12					DC-13					DC-14				
		24 V	48 V	110 V	220 V	440 V	24 V	48 V	110 V	220 V	440 V	24 V	48 V	110 V	220 V	440 V
CBD-	For contactors CI 61- CI 73 - CI 86 - CI 98	12	9	3.5	0.55	0.2	5	2	0.7	0.25	0.12	9	5	2	0.4	0.16
CBD S-		6	3	0.45	0.18	0.1	3	1.5	0.6	0.3	0.2	2	1.6	0.3	0.12	0.15

Coils, consumption and operating times

Type	Inrush power AC		Holding-power AC		Pull-in voltage AC	Drop-out voltage AC	Make time AC	Break time AC
	[VA]	[W]	[VA]	[W]	[V]	[V]	[ms]	[ms]
CI 61- CI 73 - CI 86 - CI 98	200	16	16	4.5	(0.85 – 1.1) × U _s	(0.3 – 0) × U _s	18.5 – 30	10 – 60

RC Element (charge suppressor)

Type	Comments	Overvoltage factor $\frac{U_{max}}{U_n}$
RCD	Suitable for contactors CI 61, CI 73, CI 86	1 – 3

Max. load control circuit (contact system)

Type	Load		Max. fuse	
	AC-15	DC-13	gI, gL, gG	BS 88 type T
TI 80	500 V, 2A, 200 VA	250 V, 2 A, 20 W	4 A	6 A
TI 86	500 V, 2A, 200 VA	250 V, 2 A, 20 W	4 A	6 A

UL / CSA Specifications
UL/CSA approved loads

Type	Motor load (AC-3) [hp]						Other loads (AC-1) [A]			
	1-phase		3-phase				UL		CSA	
	115 V	230 V	200 V	240 V	460 V	575 V	40 °C ¹⁾	60 °C ¹⁾	40 °C ¹⁾	60 °C ¹⁾
CI 61	5	10	15	20	40	50	90	90	90	90
CI 73	5	15	20	25	50	60	90	90	90	90
CI 86	7.5	15	25	30	60	60	100	100	100	100
CI 98	10	20	30	30	75	75	120	120	120	120

¹⁾ 40 °C is defined as non-enclosed installation.
60 °C is defined as enclosed installation.

Auxiliary contacts, UL/CSA approved loads

Type	Comments	Load capacity			
		[AC]		[DC]	
		Category	[VA]	Category	[W]
CBD	For contactors CI 61- CI 73 - CI 86- CI 98	A600	720	Q600	69
CBD S	For contactors CI 61- CI 73 - CI 86- CI 98	A600	720	Q600	69

Connections, main contacts

Type	Connection method	Single and multi core [AWG]	Tightening torque [lb-in]
CI 61, CI 73, CI 86, CI 98	Screw and clamp washer	14 – 2	18 – 52
TI 80, TI 86	Screw and clamp washer	16 – 3	7 – 30

Dimensions

Contactor CI 61, 73, 86, 98

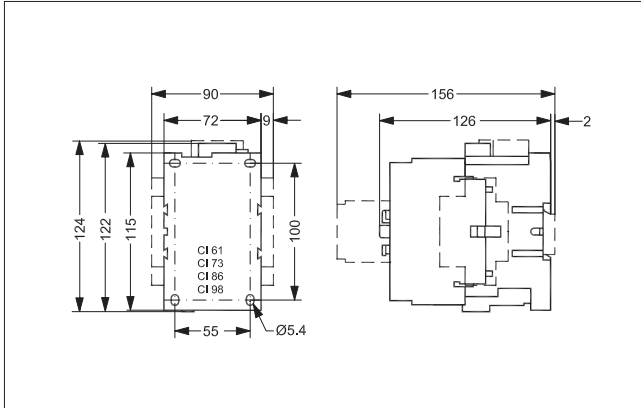

Contactor CI 61, 73, 86, 98 built together with thermal overload relay TI 80-86

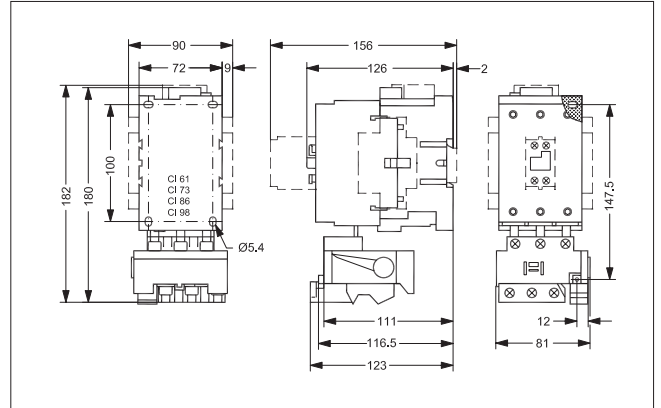

Drilling dimensions

CI 61, 73, 86, 98 with mechanical interlock

Thermal overload relays TI 80 and TI 86 for contactors CI 61, 73, 86

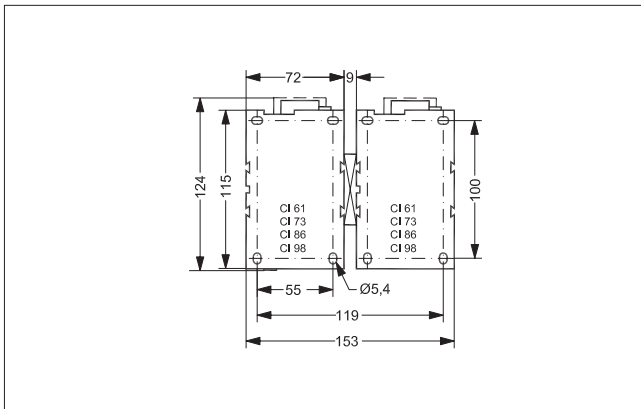

Thermal overload relays TI 80 and TI 86

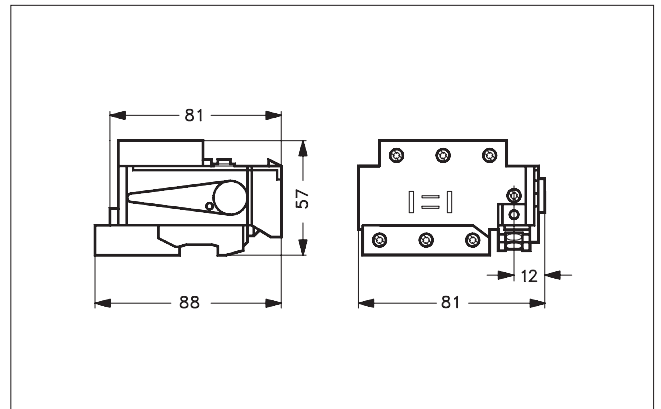

Thermal overload relay TI 80 / TI 86 on base plate

