

Mastergenerator G3800 X036



Operation Manual

Last Update: January 2016

Table of Contents

Table of Contents	2
1. Introduction	4
1.1. Start-up	4
1.1.1. Hardware requirements	4
1.1.2. Installation	4
1.1.3. Start-up of program	4
1.2. Functions in the main window	5
1.2.1. File menu	5
1.2.2. Edit menu	6
1.2.4. Tools menu	7
1.2.3. Options menu	7
1.2.5. Help menu	11
1.2.6. Configuration of channel functions	12
1.3. Basic Setup	13
2. Objects	15
2.1. General	15
2.2. Standard objects	15
2.2.1. Blank / Indicator	15
2.2.2. Push-button	16
2.2.3. Toggle switch	18
2.2.4. Timer/Recycler	20
2.2.5. Real-time clock / Night setback	23
2.2.6. Master function	25
2.2.7. Light Synch	28
2.2.8. Guide Light	28
2.2.9. Multigate	30
2.2.10. Thermostat	31
2.3. Special objects	32
2.3.1. Analog sensors	32
2.3.2. Motion detector	36
2.3.3. Dimmer functions	38
2.3.4. Light functions	41
2.3.5. Temperature Control	43
2.3.6. Wireless Base	45
2.4. Alarm functions	47
2.4.1. Overview	47
2.4.2. General features	47
2.4.3. ISA Alarm	48
2.4.4. Smoke Alarm	53
2.4.5. Intruder Alarm	58
2.4.6. Water Alarm	64
2.4.7. Common Siren	69
2.5. Roller blind control	70
2.5.1. Decentralized roller blind up-down function	70
2.5.2. Roller blind master	74
2.6. Counter and Multiplexer	77
2.6.1. Multiplexer (transmission of counter values)	77
2.6.2. Multiplexer (transmission of analog values)	79
2.7. Reference to data from other Dupline networks	81
2.7.1. General	81
2.7.2. External reference	81
2.7.3. Read external input	82
2.7.4. Status Indicator	83

3. Logic Setup	84
3.1. Introduction	84
3.2. The dialog - logic functions	84
3.2.1. Setup	84
3.3 Application	85
3.3.1. Setups and Functions	85
3.3.2. Inversion and Edge Triggering	86
3.3.3. Using the on-board I/Os	87
3.3.4. Internal processing of the logic setups	87
3.4. Notes and Documentation	87
3.4.1. Input definitions	87
4. Communication Ports	88
4.1. General	88
4.2. Protocol	88
4.3. COM1	88
4.4. COM2	88
4.5. RS485	89
4.6. Setup of Communication Ports	90
5. GSM Modem functions	92
5.1. SMS Setup	92
5.2. Event-based SMS messages	94
5.3. SMS Control commands and Requests for Dupline data	95
6. Data Logging Functions	96
6.1. General	96
6.2. Dupline-Online	96
6.3. Dupline-Online Transmission Media	97
6.3.1. Using GSM Modem	97
6.3.2. Using the Internet	97
6.4. Event-based logging	97
6.5. Time-based logging	98
6.5.1. Introduction	98
6.5.2. Time-based logging of Analink channels	98
6.5.3. Time-based logging of Counters	99
6.5.4. Time-based logging of Multiplexed Analog data	100
6.6. Export of the Configuration to the Dupline-Online Webserver	101
6.7. Dupline-Online Data Security	101
7. Radio Modem Functions	102
7.1. General	102
7.2. Setup of Radio Modem Central	103
7.3. Setup of Radio Modem Substation	104
Appendix A	105
Appendix B - ModBus Functions	106
Appendix C - RS485 Communications	112

1. Introduction

The G3800 tool has been designed for configuration of the Mastergenerators G3800x015, G3800x016 and G3800x036.

All functions in the mastergenerator are represented by graphic symbols, and all function related parameters and comments are setup locally in the PC, and then transferred to the Mastergenerator through RS232. Likewise, data from the Mastergenerator can be uploaded and modified.

The Mastergenerator firmware and configuration tool are subject to changes, as new functions are added continuously. Please check the download section at our homepage www.dupline.com for the latest updates.

1.1. Start-up

1.1.1. Hardware requirements

- The program operates under Windows 95/98/2000/xp and NT and requires at least:
- 400Mhz Pentium II processor with 32 Mbytes Ram or higher
- A free serial port (Com1 or Com2)
- 10 Mbytes hard disk for installation
- Screen resolution of 800 x 600 pixels, 256 colours or higher
- Mouse or other pointing tool desirable, but not necessary

1.1.2. Installation

Insert the CD rom and run the program "Setup.exe". This will guide you through the installation process. After installation, the program can be started by clicking G3800xxxxTool.

1.1.3. Start-up of program

When G3800xxxxTool is started, two windows will open:

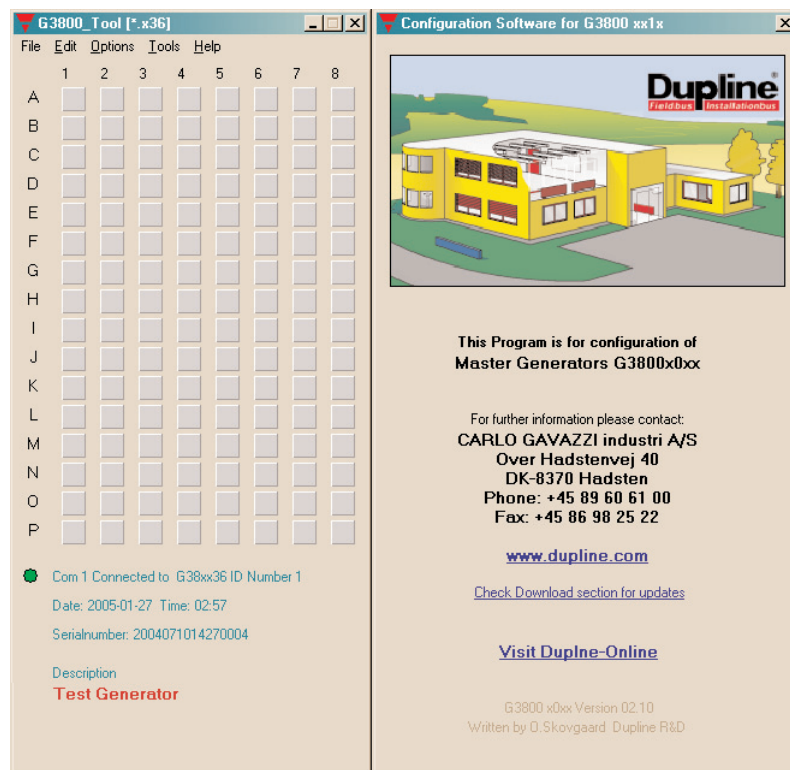

To the left, the main window showing the 128 addresses available in Dupline and the menus. To the right, the properties window, which for each function shows the parameters related to the selected functions.

A third window may appear, which also contains configuration entries, or functions for maintenance and test.

1.2. Functions in the main window

1.2.1. File menu

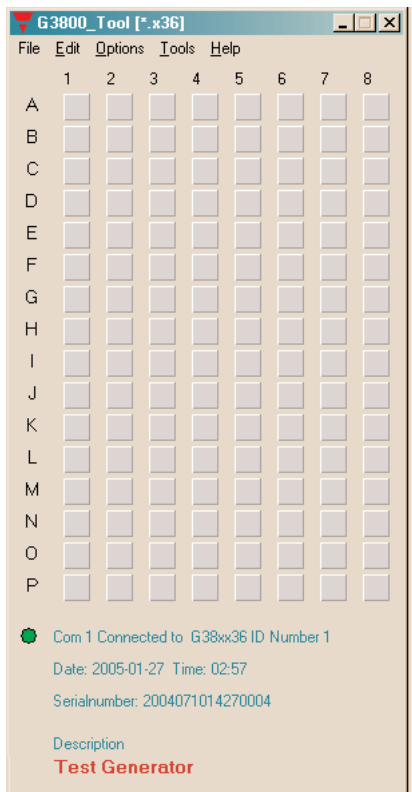

The file menu contains the usual functions:

Menu Item:	Explanation
New:	Start from the beginning with default data
Open:	Open existing file
Save:	Save file
Save As:	Save file under new name
Write Mastergenerator:	Download the present configuration file to the Mastergenerator
Read Mastergenerator:	Read the configuration file from the Mastergenerator
Export configuration: ¹⁾	Create Dupline-Online configuration file to be exported to the Central Server during registration (see chapter 6)
Print:	The following options are available: Print-out of: Address Listing Master Channels & multigate Real time Channels Logic Settings SMS Setup Input definitions External References
Exit:	Exit program

¹⁾ Only selectable for G380xx36

1.2.2. Edit menu

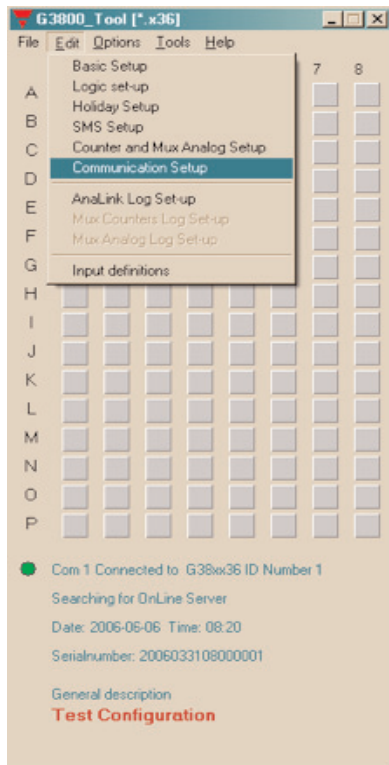

Menu Item:	Explanation:
Basic Setup:	Basic setup of the Mastergenerator
Logic Setup:	Configuration of logic functions
Holiday Setup:	Setup of holiday period. The holiday setup is active when the current date falls within any of the set time intervals.
SMS Setup	Basic setup of the SMS messaging functions facilitated by the built-in GSM modem.
Counter and Mux analog Setup:	Basic setup of the multiplex functions required when Counter Modules and Multiplexed Analog Modules are used.
Communication Setup:	Configuration of the communication functions available for the two RS 232 ports and the RS485 port of the Mastergenerator.
Analink Log Set-up ¹⁾	Basic Set-up for logging of Analink values (see chapter 6)
Mux Counters Log Set-up ¹⁾	Basic Set-up for logging of Counter vlaues (see chapter 6)
Mux Analog Log Set-up ¹⁾	Basic Set-up for logging of Multiplexed Analog values (see chapter 6)
Input definitions	Entry and management of transmitters and their respective addressing.

1) Only selectable for G3800X036

1.2.3. Options menu

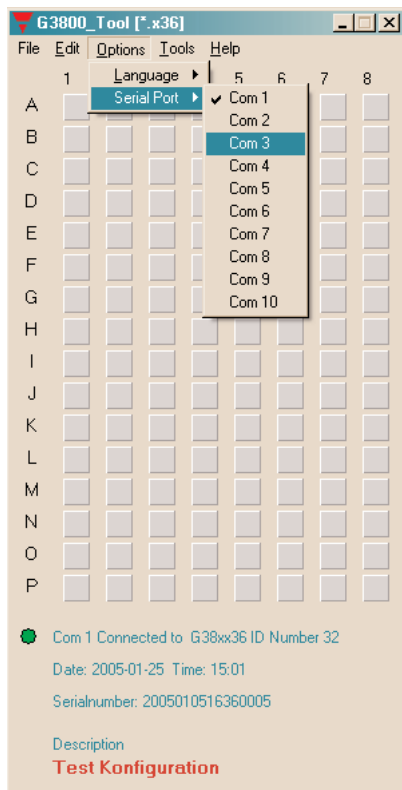

Menu Item:	Explanation:
Language:	Select between available languages. By using the “Select new” menu, other languages can be chosen to appear in the language menu.
Serial port:	Selection of serial communication ports from Com 1 to Com 10, for connection of the Mastergenerator.

1.2.4. Tools menu

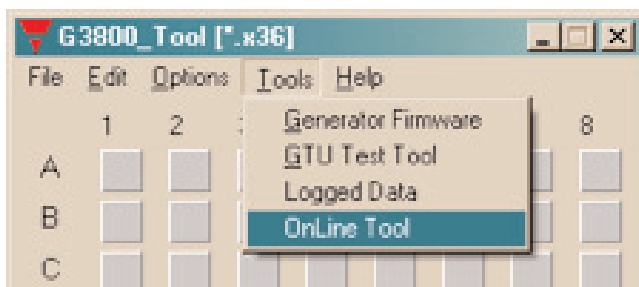

1.2.4.1. Generator firmware:

In this menu it is possible to download a new firmware file to the Generator.
New firmware files are typically made available when new features are added to the Generator.
Three steps need to be carried out:
1. Browse to select the desired firmware file.
2. Activate the Download button and follow the emerging dialog-boxes.
3. Activate Close button when done.

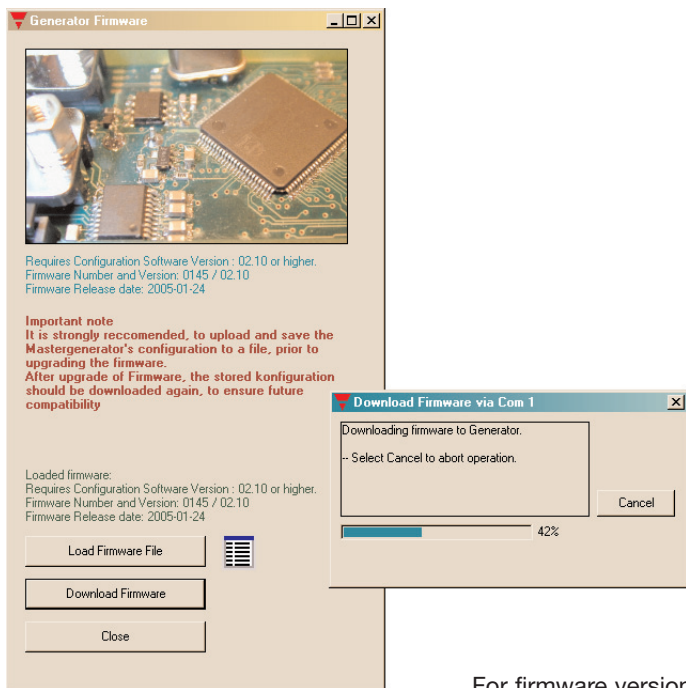

For firmware version 2,0 and onward, see part 3.3.3.: Using the on-board I/Os

1.2.4.2. GTU Test Tool:

These tools are used to display the immediate digital status on the Dupline channels.
When enabled, control of the Dupline channels is possible as well.
This tool provides a good overview of the activity on the Dupline bus and is particularly good when testing the application.

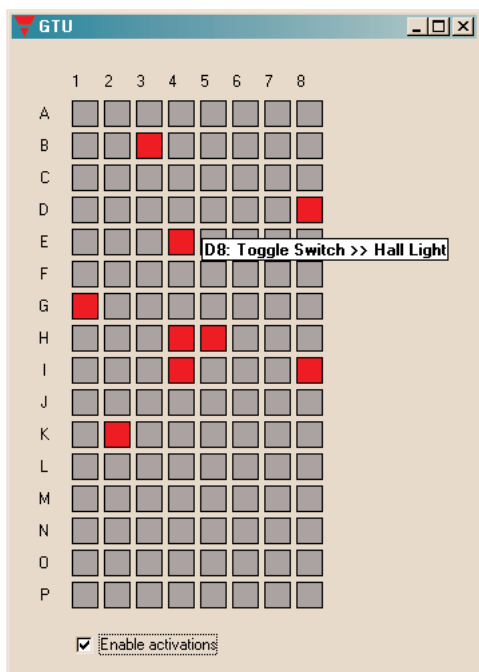

1.2.4.3. Logged Data:

When connected to the G3800x036, this menu becomes active.
 This tool enables uploading of the logged data, and displays the information in a simple readable manner.
 Mark the check boxes for what info to display.
 Press the button "Upload Log" and follow the emerging dialog-boxes.
 After a while, data are displayed as listed text information.
 Select the information, to view, and press the Refresh button.

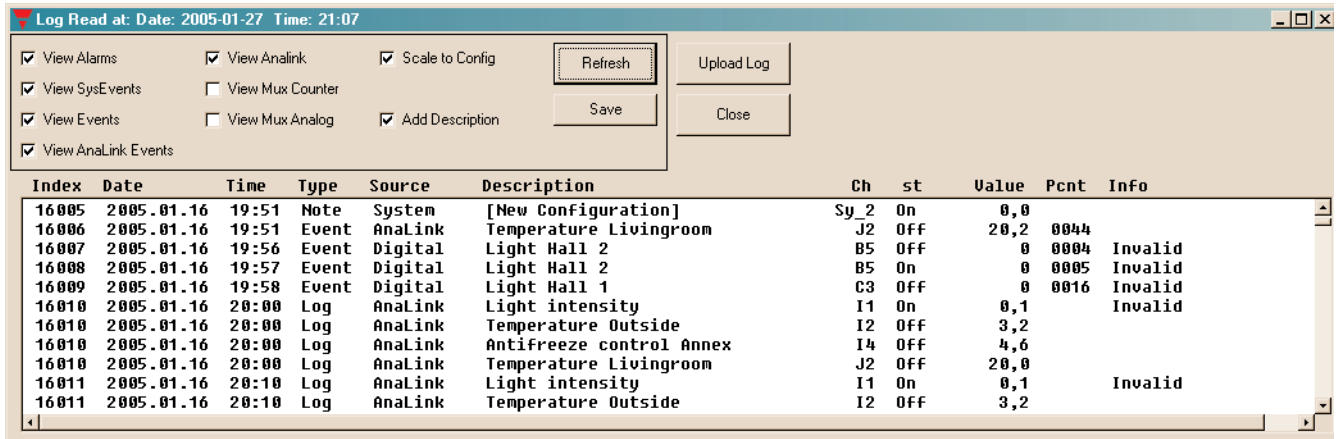

1.2.4.4. OnLine Tool:

When connected to the G3800xx36, this tool becomes available.
 The functions are used to test functionality, in conjunction with the "Dupline-OnLine".

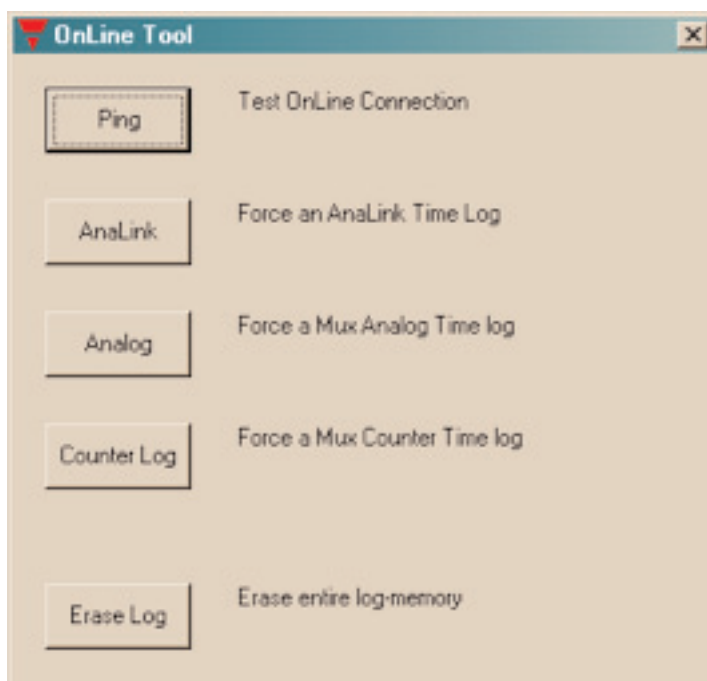

Ping: Pressing this button causes a "Connect to Server" telegram to be sent from the Mastergenerator to the Dupline-OnLine server.

While connection is established, the status may be monitored on the main-window.

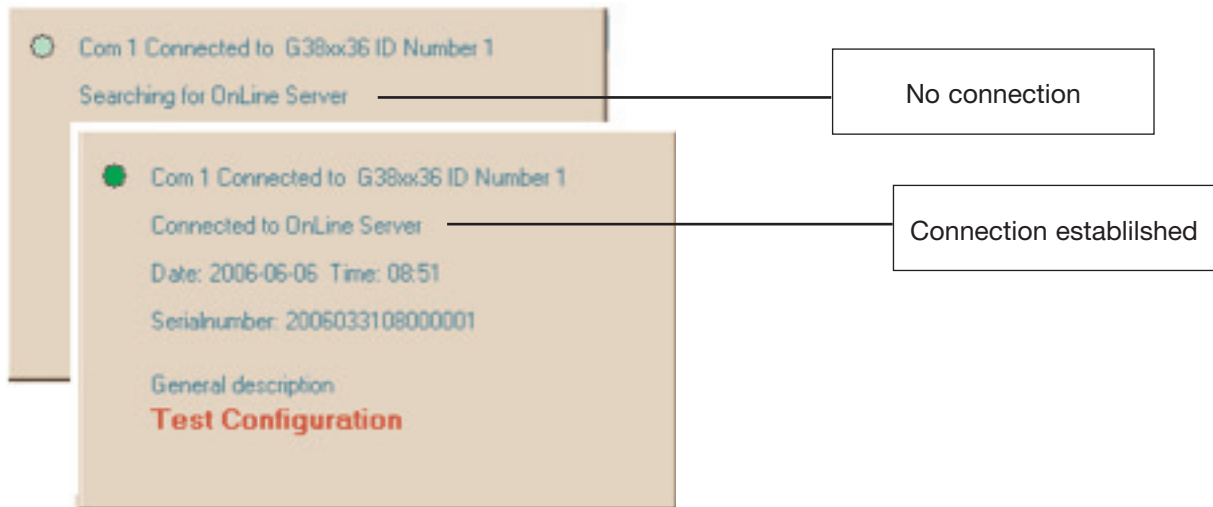

AnaLink: Activating this, forces an AnaLink Time log

Analog: Activating this, forces an Mux Analog Time log

Counter Log: Activating this, forces a Mux Counter Time log

The respective logs should be configured in the mastergenerator, in order to make a simulated time-log.

Erase Log: Pressing this, will cause the log-memory in the Mastergenerator to be erased.

Important note: this function will cause the Mastergenerator to be restarted, hence this should only be used while the Dupline wires are disconnected.

1.2.5. Help menu

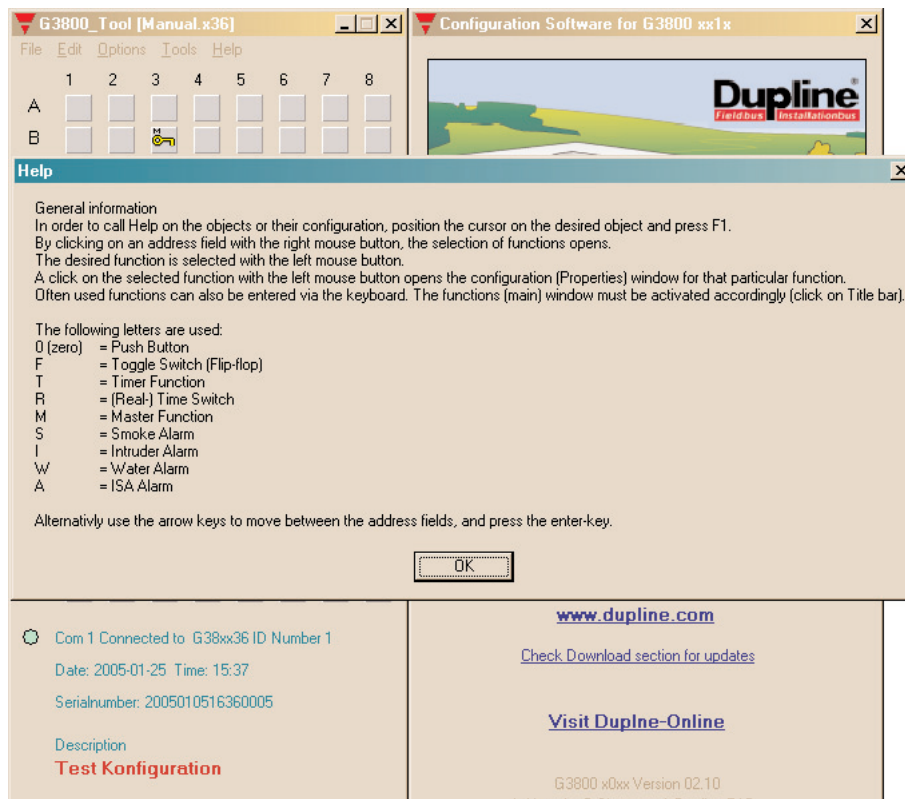

Menu Item:	Explanation:
General information:	You can call the Help menu at any time by pressing F1.
About program:	Shows the opening screen

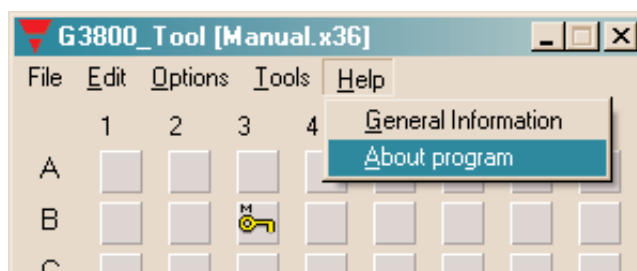

1.2.6. Configuration of channel functions

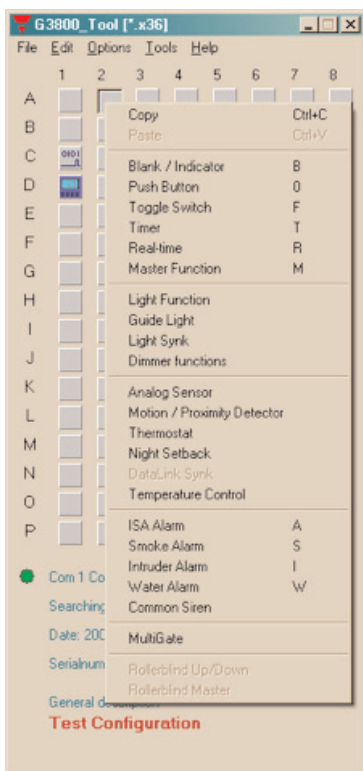

When the basic settings have been made under "Basic Setup", the functions of the remaining channels to be used are defined as follows:

Activate one of the channels, then click on the right mouse button for pop-up menu. Click on the desired channel function with the left mouse button. The channel is thereby assigned a symbol indicating the selected channel function. Click on the symbol with the left mouse button, and the parameters which can be set for that particular channel function can be viewed in the properties window.

The arrow keys can also be used to select channel function in the pop-up menu. Furthermore, channel function can be selected by clicking on different letters. To see how to select functions by clicking on letters, select the General information menu under Help.

Tool tip

When the cursor is positioned on an address button, a so-called "ToolTip" appears. The ToolTip indicates the address function, and the user-defined description.

Two "!!" in front of the tool-tip indicates, that the address also is controlled by a logic function.



1.3. Basic Setup

General description

The text window is for entering general information, eg name of user, date of configuration, reference to documentation, etc.

No. of Adresses

For selection of the number of channels desired in the system. The minimum is 16, the maximum is 128 in one Dupline network.

Restore Channel Status upon Power-up

When this function is selected, the Mastergenerator will memorize the channel status on toggle channels and real-time channels in case of a loss of power. The Mastergenerator will then restore the output status on these channels when the power comes back.

The option can not be selected, unless the Generator is connected to the PC.

Channel restore Interval (1/10 Seconds)

In order to reduce the total in-rush current when using the "Restore Channel Status upon Power-up" function, it is possible to define a delay between the activations of outputs. The delay is entered in 1/10 Seconds.

Long Activation time

Set-up the time, for how long a 'Long activation' must last, before an activation takes place.

Some channel objects, are able to be activated by a long activation from another address.

Eg. B2 is a Masterfunction, which reacts on a long activation of B1.

B1 may be a toggle switch for normal on/off.

Now by holding the B1 for the Long activation time, the Masterfunction on B2 activates, this gives B1 two functions, and saves one push-button.

Enable automatic update of realtime status upon Config-download and System power-up

If this box is checked, the Generator will automatically set the correct status for realtime channels according to the switch-time settings, provided that the actual Day of the week matches the internal Day of the week of the Generator. Also, the Generator will only scan the switch times (ON or OFF) for that same day.

Enable Automatic Daylight saving. Central European Time standard

If this box is checked, the Generator will automatically change the time settings 2 times per year according to the European standard for daylight savings.

Enable RTC Powerline Autocalibration

Selecting Auto-calibrate, will enable the internal Realtime clock to adjust its internal calibration against the Mains-supply frequency. In most countries, the Mains-supply frequency is very accurate, and in that case an improved accuracy on the Realtime clock can be achieved.

Synchronize Time to PC date and Time

If this button is activated when the Generator is connected to the PC, then the PC date and time will be transferred to the realtime clock of the Generator.

2. Objects

2.1. General

The objects are representations of the various functions supported by the Mastergenerators. The functions are assigned to Dupline addresses, and the associated parameters determine the specific operation of the channels.

2.2. Standard objects

2.2.1. Blank / Indicator

	<ul style="list-style-type: none"> • Function: None • Application: Activation of output channels through master functions, logic setups or status indicator • Insert with mouse ("Blank Indicator")
---	--

Description

The use of blank objects in Dupline is based on the circumstance that in- and output are independent of each other. Since this object does not fulfill a function between in- and output, an input on the address configured as blank function will be ineffective.

At the same time, it is possible to control the channel - and consequently the functions coded for the address - either through the master function (see chapter 2.2.6) or as output of logic setups (see chapter 3) or as status indicator, where the object's output is configured to be a copy of an address from an external Dupline® network.

In addition, a blank channel can be used as a monostable flag.

Parameters

Configuration window:

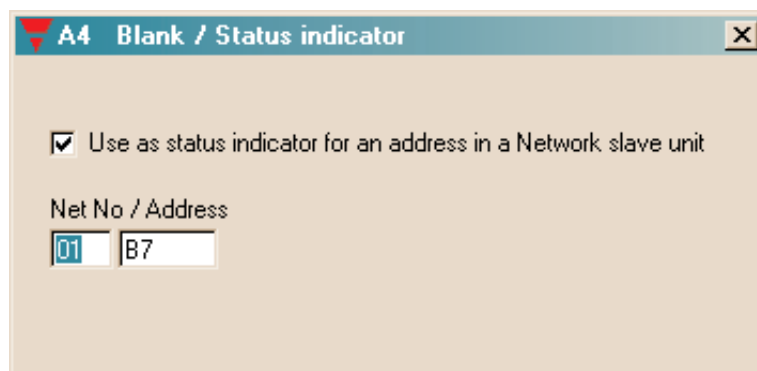

Parameter	Description
Status Indicator	When this function is selected, the output of the channel becomes a copy of the output of the address defined in the field "Net No / Adress".

2.2.2. Push-button

	<ul style="list-style-type: none"> • Function: Monostable • Application: Connection of push-button switches and contacts for load switching • Also Normally Closed function
---	--

Description

The push-button function - the most simple object of the Mastergenerator - makes it possible to connect any type of push-button switch and contact to the Dupline bus. With this function, outputs can indirectly be controlled with logic functions.

In this function, the output follows the input signal: the output is activated as long as the input signal is ON (inverted in Normally Closed function).

Parameters

Configuration window of push-button function:

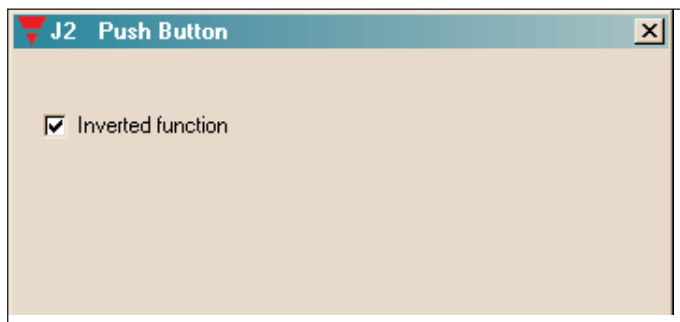

Parameter	Description
Inverted function	When this function is selected, the output signal is inverted. This means that the output is activated as long as the input has not been set.

Time characteristics

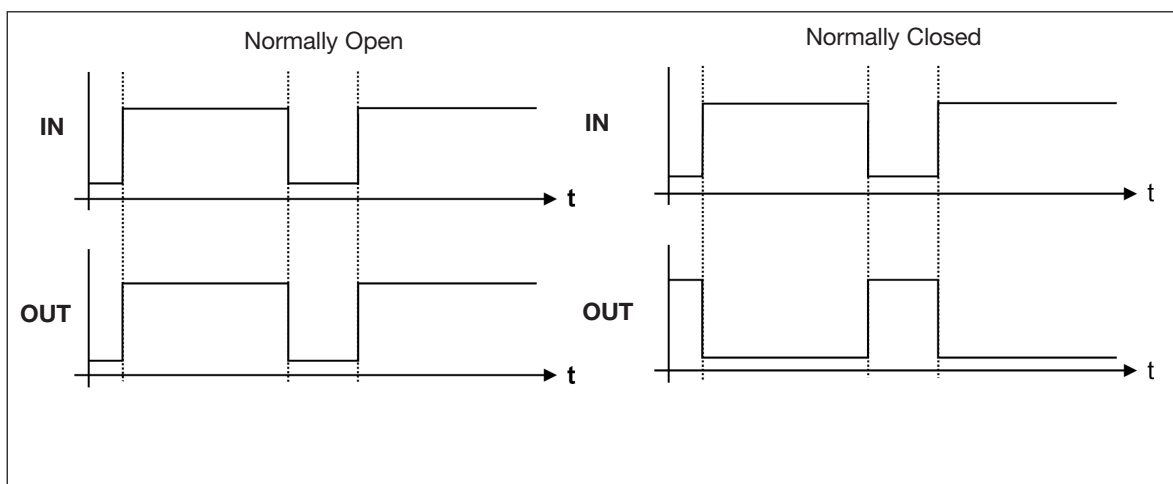

The output follows the input upon a short delay. In the Normally closed function, the output function is the opposite of the input function.

Application Example

Task: A lamp is to be switched on and off by means of a switch.

Solution: Use for example the universal input module to provide the input signal and configure one of the inputs for address A1. Assign the same address to one of the outputs of a relay module. Finally, configure channel A1 in the Mastergenerator as push-button function.

Object	Function	Channel
In-/outputs		
Relay output	Lamp	A1
Switch	Light switch	A1
Configuration		
Push-button function	Light control	A1

2.2.3. Toggle switch

	<ul style="list-style-type: none"> • Function: Bistable Flip-Flop • Application: Connection of switches and contacts for load switching • Can be used in intruder alarm systems
---	--

Description

The toggle switch is used for the basic Light-switching. The status of the address changes to its opposite upon every new activation.

Parameters

Configuration window of the toggle switch function:

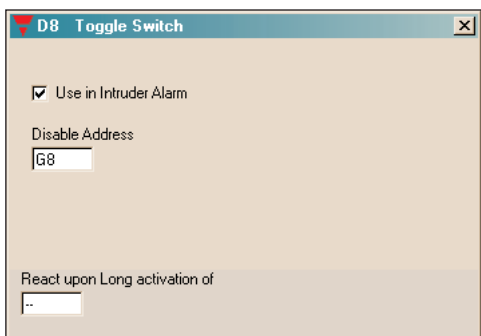

Parameter	Description
Intruder alarm	When this function is selected, the input will send a signal to the intruder alarm system to cause the siren to start. This requires that an intruder alarm is configured, and that the Intruder alarm is armoured.
Disable Address	When the address here is activated, the signal sent to the Intruder alarm is disabled, in this manner more alarm-zones may be created.
React upon Long activation of	When the address here has been activated for the 'Long Activation time', the switch-function will execute.

Time characteristics

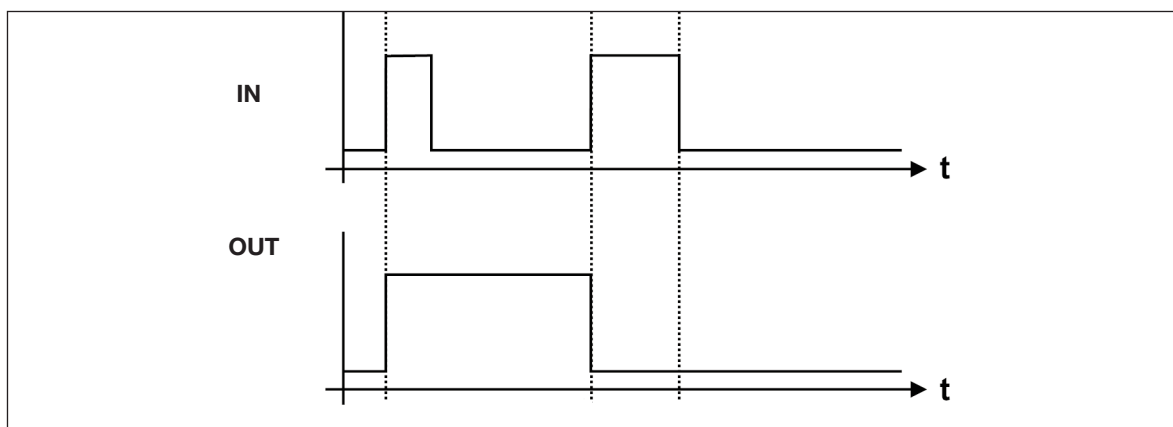

The first triggering of the input switches the output on, the second triggering switches the output off again.



Application Example

Task: A lamp is to be switched on and off by means of a conventional switch.

Solution: Use for example the universal input module to provide the input signal and configure one of the inputs for address A1. Assign the same address to one of the outputs of a relay module. Finally, configure channel A1 in the Mastergenerator as switching function.

Object	Function	Adress
In-/outputs		
Relay output	Lamp	A1
Switch	Light switch	A1
Configuration		
Toggle switch function	Light control	A1

2.2.4. Timer/Recycler

	<ul style="list-style-type: none"> • Function: Timer or Recycler • Application: Switching with on- or off-delay or recycler • Activation by signal or impulse • Activation by additional channel or flag
	

Description

This object makes it possible to select between two modes of operation: timer and recycler. In both modes, an input coded to the channel of the timer starts the functions, but the input can also be activated by a different channel or flag.

Timer (with on-delay or off-delay)

The timer allows the setting of an on-delay and/or an off-delay. When an input coded to this channel is activated, the on-delay starts. After elapse of this delay, the Off-Time starts. The Off-Time stops after the set time, if the input is released before expiry of the set time. If the input is not released, the output remains activated.

Recycler

If the recycler is activated by an input, the recycler continuously generates a square-wave signal. The output is activated after the set On-time period and de-activated after the set Off-time period. This process is repeated, as long as the input or the additional trigger is ON.

Parameters

Depending on the options selected under Timer function, a number of parameters can be selected for Timer and Recycler:

Timer (with on-delay or off-delay)

Configuration window for timer with on- or off-delay:

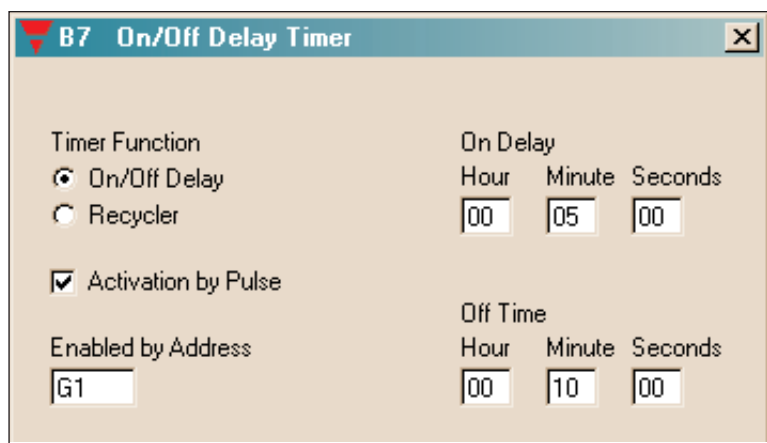

Parameter	Description
Timer function	Select the option On-Off delay in order to use the Timer function
Activation by pulse	Select this option to start the timer by means of a short impulse, eg through a push-button switch
On delay	Enter the time (0 s to 99 h, 59 min, 59 s) which must pass before the channel is activated
Off time	Enter the time (0 s to 99 h, 59 min, 59 s) for which the channel should be activated

Parameter	Description
Enabled by address	Entering of an additional address (A1..P8) or flag which will also enable the timer function. To prevent locking, the channel assigned to the timer itself must not be used. If the additional signal is an impulse, select the option Activation by pulse.

Recycler

Configuration window for recycler

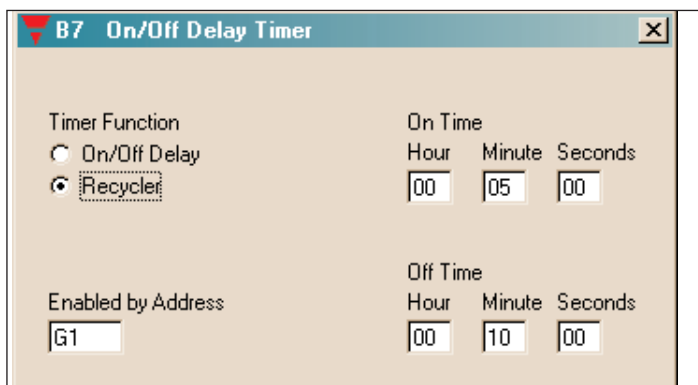

Parameter	Description
Timer function	To select the Recycler function, select "Recycler"
On-time	Entering of the time (1 s to 99 h, 59 min, 69 s) for which the output is On during recycling
Off-time	Entering of the time (0 s to 99 h, 59 min, 59 s) for which the output is Off during recycling
Enabled by address	Entering of an additional channel or flag which will also enable the recycler. To prevent locking, the channel assigned to the recycler itself must not be used.

Time characteristics

On- Off-delay timer, started by pulse.

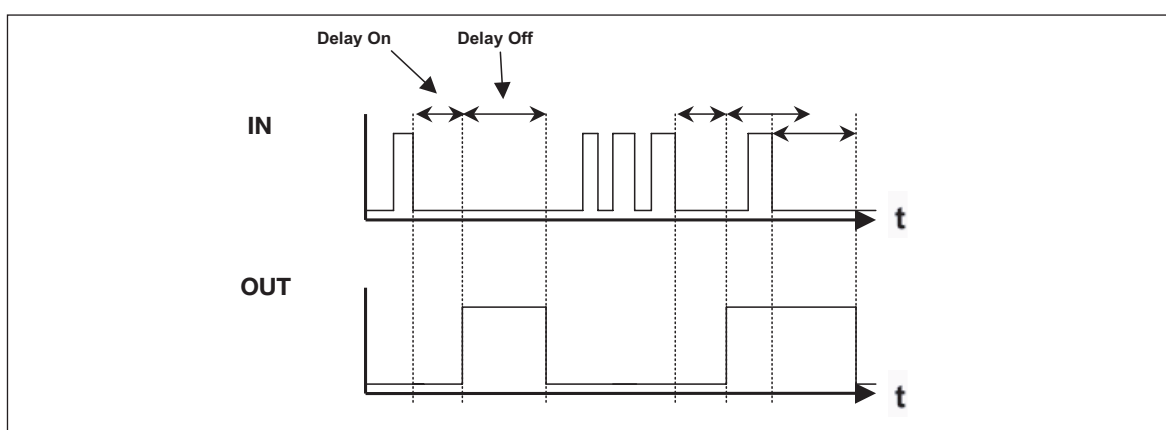

The on-delay starts upon deactivation of the input. After elapse of the On-delay, the Output turns on, and the Off-time is started.

After elapse of the Off-time the output switches off again.

Repeating the activation-pulse while the output is Off will restart the On-delay.

Repeating the activation-pulse while the output in On will restart the Off-time.

Recycler

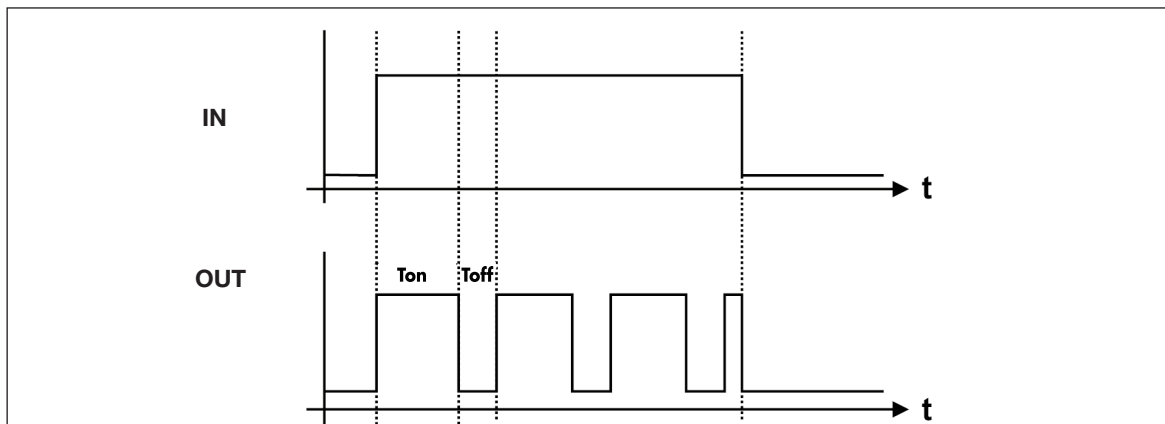

The impulse is generated upon activation of the input. A pulse cycle consists of the On-time and the Off-time. When the input is switched off, the pulse cycle stops.

Application Example



Task: A fan in a bathroom is to start 5 min after the light has been switched on and run for 10 min.

Solution: The lighting is activated by a push-button connected to a sensor module (for example a universal input module) and configured for address A1 as a toggle switch function. An output of a relay module is assigned the same address and activates the lighting. A second channel A2 is configured as Timer and activated by the above-mentioned push-button. An additional channel of the output module is also assigned the address A2 and activates the fan.

Object	Function	Adress
In-/outputs		
Relay output	Bathroom light	A1
Switch	Light switch	A1
Relay output	Bathroom fan	A2
Configuration		
Toggle switch function	Light control	A1
Timer	Fan control	A2

By use of the additional trigger A1, the timer starts when the light is switched on.

2.2.5. Real-time clock / Night setback

 	<ul style="list-style-type: none"> • Function: Real-time clock with week and holidays • Application: Real-time-controlled switching • Also applicable as switching function • Holiday setting can be performed centrally for all clocks
--	---

Description

The real-time clock enables on- and off-switching of loads in relation to the internal time setting of the Mastergenerator. It is possible to pre-define up to four switch-on and switch-off times for each clock on freely optional weekdays and holidays.

The Night setback is merely another icon to distinguish a specific purpose of the real-time function

Parameters

Configuration window of real-time clock function:

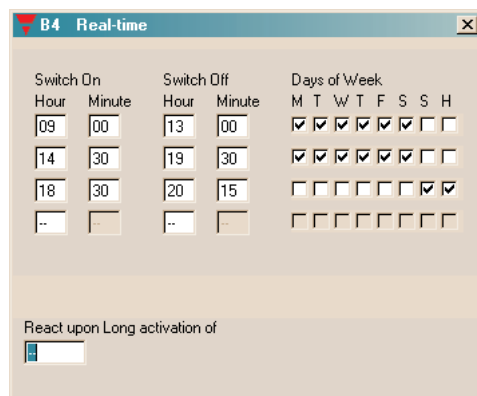

Parameter	Description
Switch-on time	Time at which the channel is to switch on
Switch-off time	Time at which the channel is to switch off
Days of week	Day(s) on which the switching time indicated to the left applies (M: Monday, T: Tuesday, W: Wednesday, T: Thursday, F: Friday, S: Saturday, S: Sunday) If "H" is activated, the clock also switches on holidays. In this case, the corresponding days must be entered under <Edit><Holiday setup>.
React upon Long activation of	When the address here has been activated for the 'Long Activation time', the switch-function will execute.

Time characteristics

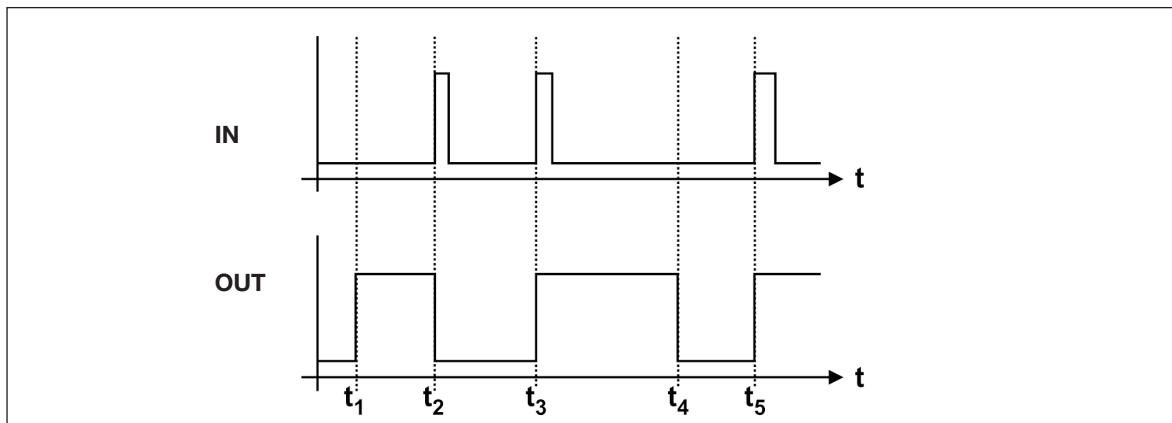

t_1 : The real-time clock activates the output at the pre-defined time without affecting the input channel.

t_2 : By activation of the input, the output switches off directly.

t_3 : By activating the input once more, the output switches on again.

t_4 : At the set Switch off time, the output is always deactivated.

t_5 : The output can always be activated again through the input.





Application Example

Task: A lamp is to be switched on and off by means of a real-time clock.

Solution: Assign adress A1 to one of the outputs of a relay module. Then configure A1 in the MCG as a real-time function.
 Make the settings for "Switch on", "Switch off" and "Days of week".
 Now the lamp is controlled by the real-time function.

Object	Function	Channel
In-/outputs		
Relay output	Outdoor lamp	A1
Configuration		
Real-time function	Light control	A1

2.2.6. Master function

   	<ul style="list-style-type: none"> • Function: Simultaneous on- and off-switching of multiple toggle switch functions, real-time clocks, etc, upon activation of input. • Integrated real-time clock with four switch times • Application: Simultaneous off- on on-switching of multiple loads, calling lighting scenes in connection with dimmers. • Bistable master function
--	--

Description

The master function allows simultaneous activation of a arbitrary number of channels. When the master function is activated, an on-signal is generated on the channels configured for switching on. Likewise, an off-signal is generated on channels configured for switching off. The objects configured for these channels thus determine the behaviour of the outputs.

Note: the following characteristics of the master function:

- A master function has priority over the individual functions at the time of activation, ie it is not possible to activate the individual channels as long as the master function is on. Upon release of the master function, the decentral functions are accepted again.
- When several master functions are activated at the same time, and targets the same addresses, the Master-On command will take precedence over the Master-Off command.
- The master function cannot affect channels with advanced functions, eg alarm channels or analog sensors.
- A master function cannot activate another master function.

Parameters

Configuration window of Master function: (In this example, a real-time clock is included and the option “Enter Switch times”:)

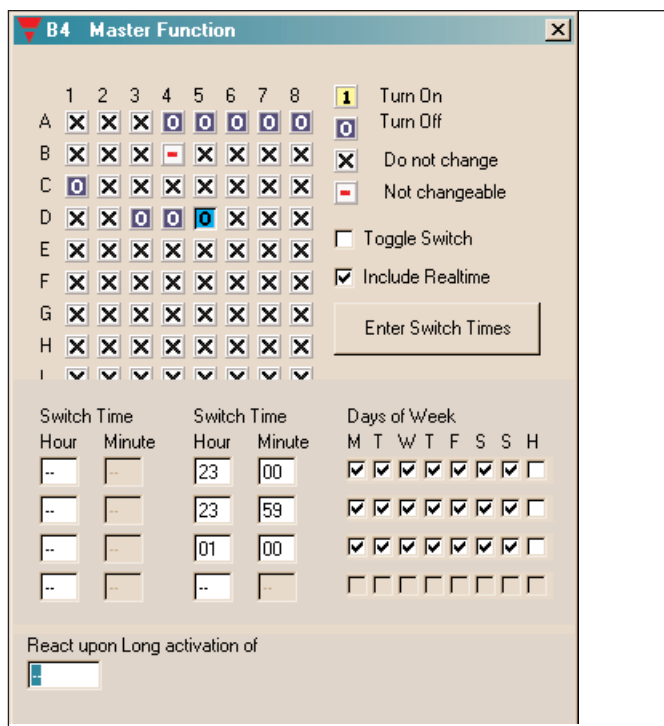

Parameter	Description
Address matrix	Mark the addresses to be switched on by the master function with "1" and the addresses to be switched off with "0".* Addresses marked with "x" are not affected. Addresses which are automatically marked with a red line cannot be controlled by a master function, eg. master functions, roller blind controls, etc.
Toggle switch	If this function is selected, the master function address behaves like a "Toggle Switch". The addresses controlled by the Masterfunction, will now be able to be turned on and off, by the same Masterfunction. If the Masterfunction address is off, the next activation will be an ON-command. The ON-command is sent to all addresses marked with a "1" Addresses in the matrix marked with "0" will turn OFF.
Include Real-time	A real-time clock is included to time-control the master function. The field "Enter Switch times" appears.
Enter Switch times	Click here to open or close for the entry of switch times
Real-time clock	Normally, the real-time clock for time-control of the master function behaves in the same way as the object "Real-time clock". See chapter 2.2.5. Real-time clock for further details. Unlike a separate real-time clock, the built-in real-time clock only generates one switching impulse. This is particularly important to bear in mind when the master function is to control push-button functions, since the switch signal has a very short duration.
As a Flip-Flop Master	The real-time function operates both ON-switching and OFF-switching. This enables simultaneous ON- and OFF-switching of multiple channels. The channels marked with "1" switch on when the master is activated and switch off upon deactivation. The channels marked with "0" behave in the opposite way.
React upon Long activation of	When the address here has been activated for the 'Long Activation time', the switch-function will execute.

Tip: Entire address groups can be changed by clicking on the right mouse button.

Time characteristics (without toggle function selected)

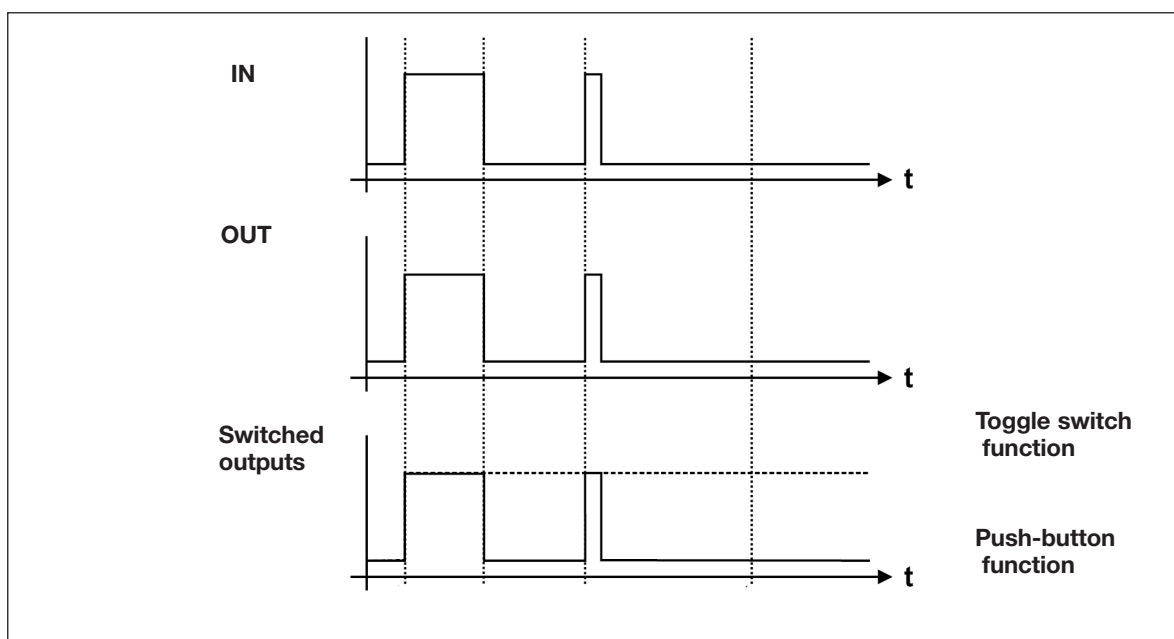

The master function remains active until the input is switched off. In the above example, the outputs switch on, and - in the case of a push-button function - remain on, until the master function switches off again.

Application Example

Task: The master function is to control four lamps in a building

- Master on: Switches all lamps on
- Master off: Switches all lamps off
- Both master functions turn on a surveillance light in the hall

Solution: Two push-buttons are configured on addresses A1 to A2 to initiate the master function for the On and The Off.
One pushbutton controls the Light in the Hall

Object	Function	Address
In-/outputs		
Push-button input	Master on	A1
Push-button input	Master off	A2
Push-button input	Push-button for call Hall light	C1
Relay outputs	Lamps	C1..C4
Configuration		
Master function	Master on	A1 turns on C1,C2, C3 and C4
Master function	Master off	A2 turns on C1 and turns off C2,C3 and C4
Toggle switch function	Lamps	C1..C4

2.2.7. Light Synch

	<ul style="list-style-type: none"> * Function: Transfer of light intensity signal * Constant light function * Select with mouse
---	--

Description

The Light Synch function is needed to synchronize the transfer of the light-intensity signal from the light sensor type G82102220 to the dimmer type G34485239.

2.2.8. Guide Light

	<ul style="list-style-type: none"> * Function: Guide light. * controllable Indicator, inverse function * Select with mouse
---	---

Description

The Guide Light object is designed to ease indications for Dupline pushbutton switches with LED indications. The object reads the address of the pushbutton, and output its status to the address of the LED indicator. When inverted function is selected, the Output acts as 'Guide Light', Led on, when switch is off. The output may be controlled by a disable address, which eases control of the object.

Parameters

Configuration window of the Guide Light function:

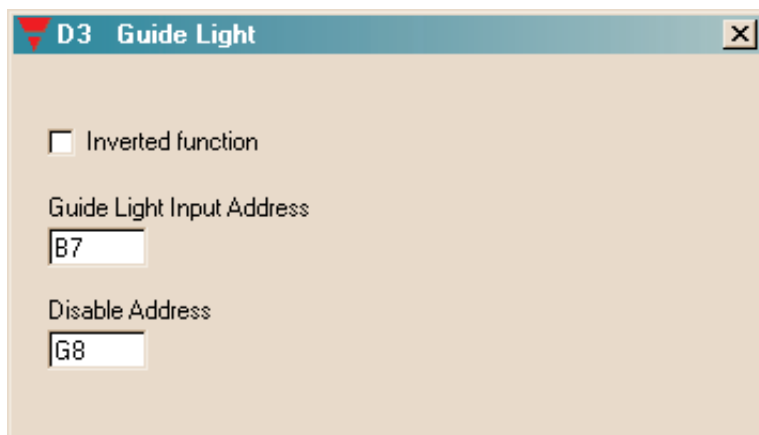

Parameter	Description
Input address	Enter the address to be monitored
Disable address	Entering of an additional channel (A1..P8) or flag (W1..Z8) which will disable the output function. To prevent oscillation, the channel assigned to the Guide Light itself must not be used.
Inverted Function	When this function is selected, the output signal is inverted. This means that the output is activated as long as the input has not been set.

Application Example

Task: A guide light function for a switch.

Solution: Use for example the universal input module to provide the input signal and configure one of the inputs for address A1.
Configure channel A1 in the Mastergenerator as push-button function.

Assign address A2 to one of the outputs of a relay module.
Finally, Configure channel A2 in the Mastergenerator as guide Light function.
Enter Input Address to A1 and check the Inverted Function.

Object	Function	Channel
In-/ outputs		
Relay Output	Lamp	A1
Relay Output	Guide Light	A2
Switch	Light switch	A1
Configuration		
Push-button function	Light control	A1
Guide Light	Indication	A2

2.2.9. Multigate

	<ul style="list-style-type: none"> * Function: Multiple input And, Or and Compare * Logic operator * Select with mouse
---	---

Description

The Multigate object is designed to ease monitoring of multiple channels. The object reads the current status of all addresses. This actual status is then held against the selected addresses which form its logic inputs. The selected logic operation of the object is executed, and the result hereof is led to the objects output.

Parameters

Configuration window of the Multigate:

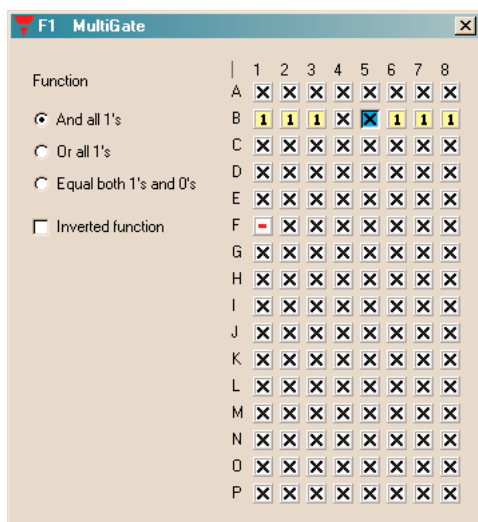

Parameter	Description
Matrix field	Select the Multi-gate input signals
AND all 1's	All the selected 1's, must be active, to activate the object's output
OR all 1's	One or more of the selected 1's, must be active, to activate the object's output
Equal both 1's and 0's	The selected 1's and 0's must match exactly, to activate the object's output
Inverted Function	When this function is selected, the output is inverted. This means that the output will deactivate when the matching condition becomes True

Application Example

Task: A pump needed to be started, upon request from 3 different temperature sensors.

Solution: Use for example 3 AnaLink temperature transmitter, coded for B1,B2 and B3. Assign address A1 to one of the outputs of a relay module.

Configure channel A1 in the Mastergenerator as a Multigate with Or function. Set-up 'One's' in the MultiGate matrix B1,B2 and B3.

Configure the 3 AnaLink sensors, to activate their output when temperature is below eg. 18 degrees.

Object	Function	Channel
In-/ outputs		
Relay Output	Pump	A1
Temperature	AnaLink temperature	B1
Temperature	AnaLink temperature	B2
Temperature	AnaLink temperature	
Configuration		B3
AnaLink Temperature	3 temperature measurements	B1,B2 and B3
MultiGate	Controls the Pump	A1

2.2.10. Thermostat



- * Function: Monostable
- * Application: Indicate address used for Digital Thermostat transmitter

Description: The Thermostat operates similar to the Push-button function, but is used to indicate an address occupied by a digital thermostat transmitter.

Parameters: None

2.3. Special objects

2.3.1. Analog sensors

	<ul style="list-style-type: none"> • Function: Transmission and output of analog values (from temperature, light and other sensors) to perform switching functions • Application: Display of analog (AnaLink) values on text display/touchscreen: load switching (for example heating elements, lamps, roller blinds) in relation to temperature or outdoor light, etc. • Readout at any time of analog values in relation to external values • Up to two switching ranges can be defined on each channel • Disabling of switching operations through an additional channel or flag • Select with mouse "Analink Sensor"
---	--

Description

The objects of the analog sensors offer the possibility of integrating analog measuring devices in Dupline and processing their values. It is possible to select among four types of sensor functions.

Measuring sensor

General sensor object, with which all the other sensor types can be integrated (the following sensors, such as the light sensor, are indicated by different icons and the measuring ranges are partly pre-defined).

Since all sensors operate in the same way, their functions are illustrated by means of the general measuring sensor.

Light sensor

This pre-defined object for the light sensor operates in the same way as the measuring sensor, but has a different icon and the preset measuring range of 0.1 to 100,000 Lux.

Wind sensor

This sensor object is intended for the integration of a wind meter (anemometer), but requires a conversion module. Apart from that, this object operates like the measuring sensor.

Temperature sensor

This object also operates in the same way as the measuring sensor, but has its own icon for easy recognition.

General information

Channels for analog transmission operate in the same way as other switching channels. For example, they cannot be switched with switches that operate on the same channel. This means that an additional channel is needed when for example a sensor only is to be switched manually and only at a certain time.

Furthermore, analog values cannot be processed by means of flags. Instead, it is possible to configure any number of analog sensors so that they relate to the same "source value".

The following table gives an overview of all parameters:

Parameter	Description
Function	Select the function of an ordinary measuring sensor, light sensor, wind or temperature sensor. Basically, all functions operate in the same way.
Disable address	When the channel or flag entered here is activated, all switching operations of the sensor are disabled.
Control output	Select this function if the sensor are used to activate a relay on the same address. If the analog value is to be read by other Dupline modules or interfaces for, then the control output should be left un-checked.
Invert limits	This option inverts the switching function in relation to the limit values.
Alternative input	Select this option to get the Analink value from another address set by the Net No / Address
Sensor input range	The upper and lower limit values of the sensor. For example, the lower value could be -30 °C, while the upper value could be 60 °C. Note: The entry of each value must be confirmed with the Enter-key.
Net No / Address	Enter the address, from where the object are to fetch its AnaLink value.
Off < Limit On > Limit or On < Limit Off > Limit	These are the switching limits of the sensor object. If the option "Invert limits" is not selected, the limit values appear as described, ie if the values "17.0" and "20.0" are entered, the channel switches off when the actual value is below 17.0 and switches on when the actual value is above 20.0. When the limit values are inverted, the sensor switches on when the actual value is below 17.0 and switches off when the actual value is above 20.0. This setting is typical for a heating control system. The limit values are only active, when the address enabling a second pair of limit values is not switched on. Note: The entry of each value must be confirmed with the Enter-key.
Enable limit 2	This option is selected in order to enter a second pair of limit values, for instance for night setback.
Off < Limit On > Limit or On < Limit Off > Limit	The second pair of limit values makes it possible to enable a different switching operation through a different address - "Enabled by address". If "Enabled by address" is activated, the second pair of limit values will apply instead of the first pair. The second pair of limit values can also be inverted by the "Invert limits" option. Note: The entry of each value must be confirmed with the Enter-key.
Enabled by address	When the selected channel or flag is not active, the first pair of limit values will apply, when it is active, the second pair will apply. The value can be overwritten at any time and deleted by the Delete-key.

Time characteristics

Sensor for display of measuring values

In this application, the displayed value follows the actual value after a short delay.

Note: The final measuring value is reached within 30 seconds from power up of the system, or if a new sensor is attached to the Dupline.

Sensor as switching channel

The time characteristics of the sensors are here illustrated by the example of a temperature sensor: the upper curve shows the room temperature, the curve in the middle shows the Disable address, and the lower curve shows temperature sensor as switching channel.

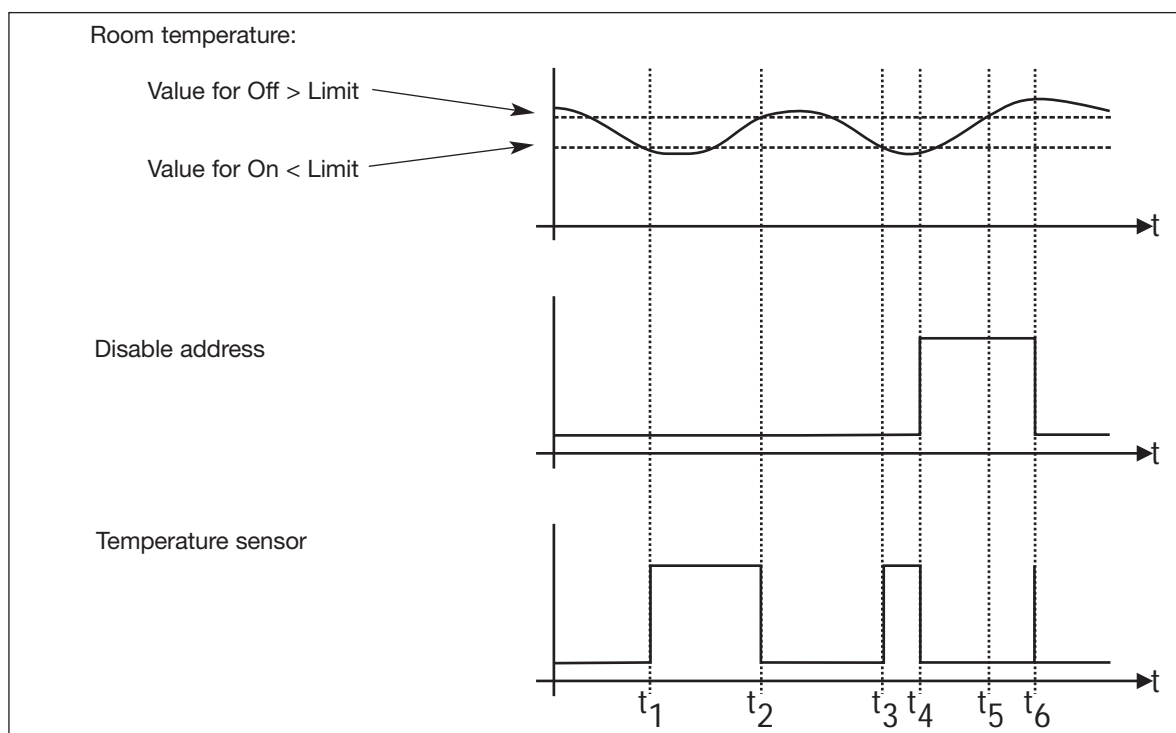

- t_1 : The room temperature drops to the value entered for On > Limit, eg 21°C. Since no Disable Address is entered, the object "Temperature sensor" switches the channel on.
- t_2 : The temperature reaches the value entered for Off < Limit, eg 17°C. Since a Disable Address is still not entered, the channel assigned to the "Temperature sensor" object switches off.
- t_3 : The room temperature reaches the lower limit value again, and the object switches on.
- t_4 : The Disable Address (channel or flag) is activated, for example through a toggle switch.
- t_5 : Although the upper limit value is reached, the object does not switch the output on, because the Disable address is active.
- t_6 : The temperature sensor switching channel does not switch off, until the Disable address is deactivated.

Application Example

Task: A heating element is to keep the room temperature between 19°C and 21°C during daytime. At night, the temperature must be lowered by 4°C.

A temperature sensor located in the room is coded for address A2 and displays the temperature on a Touchscreen.

Solution: Since the analog sensor value on A2 is already needed for displaying the temperature, we assign the temperature sensor object - and consequently the relay controlled by the heating element - to address A3.

For the night setback, we assign a real-time clock to A4 with the desired switching times. The real-time clock serves as an additional address for enabling the second pair of limit values.

Object	Function	Channel
In-/outputs		
Temperature sensor	Temperature	A2
Relay output	Heating valve	A3
Configuration		
Analog sensor: Temperature sensor	Transmission of analog value	A2
Analog sensor: Temperature sensor	Analog signal out- put and switching channel for the relay of the heating valve	A3
Real-time clock	Timer for night setback	A4

2.3.2. Motion detector



- Function: Includes motion detectors or similar input modules in the Dupline system.
- Application: Control of lamps and integration in the intruder alarm system
- Off time adjustable from 00 h 00 min 00 s to 99 h 59 min 59 s
- Variable number of movement impulses helps to avoid false alarms in the intruder alarm
- Select with mouse (“Motion detector”)

Description

The object “Motion detector” makes it possible to include Dupline Passive Infrared Detector (PIR), eg G8910 1127 and conventional motion detectors, which are connected to the Dupline bus via binary inputs.

The PIR detector can have an off time defined and be integrated in the intruder alarm system. Thereby it becomes possible to avoid false alarms by setting the number of impulses which must be detected within a 10 s time window before the alarm starts.

Note: If you want a PIR detector to generate the off time independently, the object “Push-button function” should be used.

The off time of G8910 1127 can be operated through DIP-switches.

Parameters

Configuration window of Motion detector:

Parameter	Description
Off time:	The time for which the channel remains activated (00.00.00 to 99.59.59) after a motion impulse has occurred. Each additional impulse will start the off time again. When entering an off time of 00:00:00, the Mastergenerator generates a short output signal independently of the duration of the input signal.
Number of pulses	The value entered here (1..25) determines how many impulses the motion detector may generate within 10 s, before the alarm starts. When an impulse is detected, the Mastergenerator checks whether the number of impulses during the past 10 s has exceeded the set number. If this is the case, an alarm is generated in the connected intruder alarm system. This setting thus reduces the risk of false alarms. Note: Since the signal output takes place subsequently, an additional impulse is always needed. This means that when the number of impulses is set to 3, the alarm will go off at the fourth signal. The set off time has no influence on the alarm.
Use in Intruder alarm	Click in the check box in order to include the channel in the intruder alarm system. When the Intruder alarm is armed, it will accept the information from the Motion detector as well, and cause the alarm to activate.
Disable Adress	The Disable address, when set and active. disables the signal sent to the intruder alarm. The disable address then makes it possible, to use the motion detectors in different alarm zones.
Invert PIR input signal	If the motion detector has a “normally closed” output, then this check should be marked, to make the function operate correctly.

Input-Armouring Delay	This time is taken over by the intrusion alarm as a Desarming time. When the motion detector is used in Intruder Alarm and causes an alarm signal, then the alarm siren will go off upon elapse of the Input-Armouring Delay.
-----------------------	---

Time characteristics

In the following figure, “IN” is the input channel of the motion detector or the contact, while “OUT” is the output signal of the same channel. In addition, the object “Motion detector” has been integrated in the intruder alarm system (whose alarm siren can also be seen in the below diagram). The number of impulses has been set to “3”.

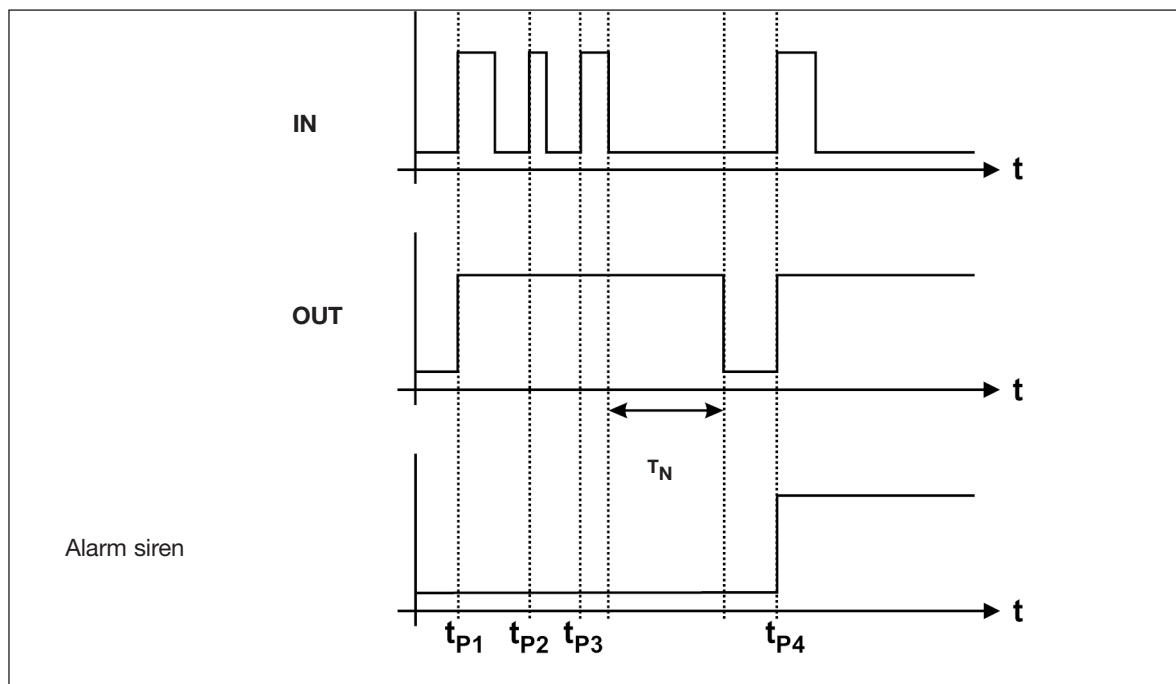

t_{P1} , t_{P2} , t_{P3} and t_{P4} are the points of time at which the motion detector generates a signal. The impulse duration depends on the characteristics of the detector. T_N is the set off time retriggered by the impulses t_{P2} and t_{P3} and therefore only begins after elapse of the third impulse.

The alarm will not start until after the fourth impulse t_{P4} , and only when the time elapses between t_{P1} and t_{P4} is less than 10 s.

Application Example

Task: A floor lighting is to switch on automatically for 5 minutes with PIR sensor G 8910 1127 and also serves as intruder alarm when the house is empty.

Solution: G 8910 1127 must be connected to the Dupline bus and given an address (here A1). In this example, increase of the signal transmission time through the DIP switch is to be switched out. Configure both the object “Motion detector” and an output channel of a relay module for address A1 and additional objects needed for the intruder alarm (Manual armouring, Alarm siren).

Also in this case, the motion detector activates the output module for the lighting directly on address A1. If the alarm system is activated via the manual armouring, the Mastergenerator generates an alarm within 10 s after the third impulse.

Additional details about the intruder alarm can be found in chapter 2.4.5.

Tip: If you want to use the Sabotage protection (Normally closed function) of the G 8910 1127, you should configure the object “Push-button function” for the normally closed function and use the increase of signal transmission time function provided by the module.

In order to include the detector with sabotage protection in an intruder alarm system, you must use the object “Active detector” of the intruder alarm system instead of the Push-button function.

2.3.3. Dimmer functions

	<ul style="list-style-type: none"> • Function: Setting up Dimmers for both the simple Dim up/down to the more complex scenarios. • Application: Setting various light scenes to adapt light setting in rooms, according to activity or moods. • Special objects designed to utilize the full functions of the dimmer modules type G3448 5234 and G4248 4134 • From 6 to 8 different scenarios from 0% (off) to 100% (full light) • Scenarios also enables the Dimmers to be controlled by the normal Master function. • Control function by Motion/Proximity detector.
---	--

Description:

The Dimmer objects offer the possibility to create advanced light controls using the full potential of the dimmer modules.





The dimmer object may consist of merely the Dim up/Down or may be expanded to include Output status, control channels and several Scenarios.

The two types of Dimmers differs, by the fact that the 2X230W (G3448 5234) has 6 scenarios

The 1x600W (G4248 4134) has 8 scenarios, and hence an extra channel for control.



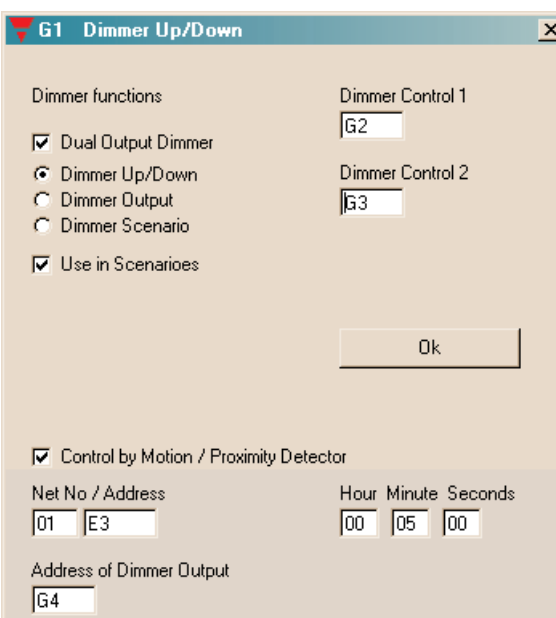

The configuration of a dimmer object progresses in successive steps to minimize false entries

The various Dimmer objects selected under Dimmer functions.
(Only the 230W type are shown for simplicity)

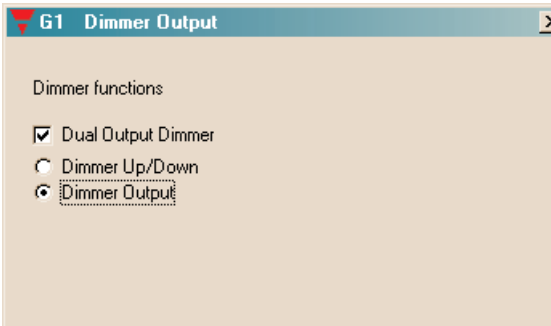
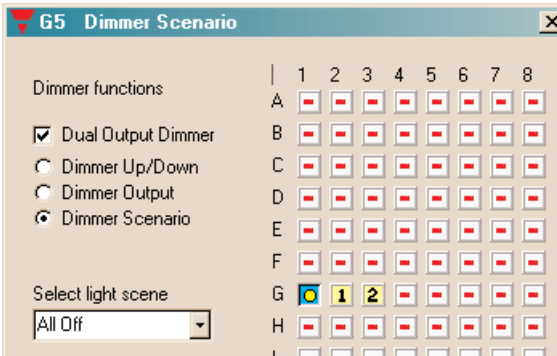
- Dimmer Up/Down:  This is the basic dimmer function, used for manually adjustment of light intensity.
- Dimmer Output:  This is the Output from the dimmer, indicating that the Dimmer's output is active.
- Dimmer Controls:   2 or 3 control inputs which in combination with the Dimmer up/down are Used to form the control-function of the Dimmer module.
- Scenario:  This object is the central control for one or more Dimmer modules.

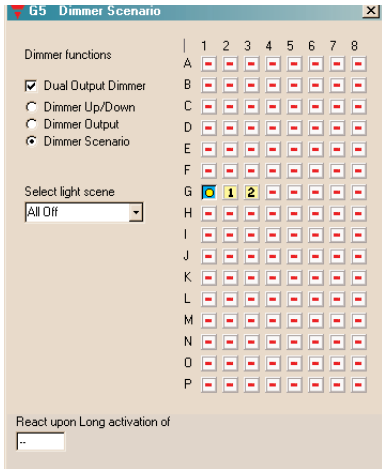
Parameter	Description
	 <p>The screenshot shows a configuration window titled "G1 Dimmer Up/Down". It contains several settings: <ul style="list-style-type: none"> Dimmer functions: <ul style="list-style-type: none"> <input checked="" type="checkbox"/> Dual Output Dimmer <input checked="" type="radio"/> Dimmer Up/Down <input type="radio"/> Dimmer Output <input type="radio"/> Dimmer Scenario <input checked="" type="checkbox"/> Use in Scenarios Dimmer Control 1: G2 Dimmer Control 2: G3 Control by Motion / Proximity Detector: <input checked="" type="checkbox"/> Net No / Address: 01 E3 Hour Minute Seconds: 00 05 00 Address of Dimmer Output: G4 An "Ok" button is visible at the bottom right of the window. </p>

Dual Output Dimmer	Select this when using the 2*230W dimmer type G3448 5234 The dimmer icons appear in Yellow colors. Deselect this when using the 1*600W dimme type G3448 4134 The dimmer icons appear in Green colors.
Dimmer Up/Down	The Basic dimmer function The selected address has to match the coding of the Dimmer module's Dim up/down input.
Control by Motion/ Proximity detector	Select this option to enable the dimmer to be controlled by a Motion detector.
Net No / Address	Enter the address from where the object is to fetch the Motion/Proximity Detector's input signal.
Hour,Minute,Seconds	The off-delay associated to the Motion detector
Address of Dimmer Output	Enter the address of the Dimmer's Output status. This is essential for the correct operation when combined with a Motion Detector. 
Dimmer Output	Change the channels function to Dimmer Output This selection also changes the channels icon. The given address has to match the coding of the Dimmer module's Status Output.
Setting up a Scenario	
Step 1	
Selecting Dimmer Controls	
	Select "Use in Scenarios", to open the entry of the Dimmer Controls. Enter the channels, to be used for the Dimmer controls. The Dimmer control channels are created by pressing the OK button. You must select a new set of controls or select an existing set of controls, thus more Dimmers may share the same set of Dimmer control channels. The given addresses has to match the coding of the Dimmer module's control inputs.

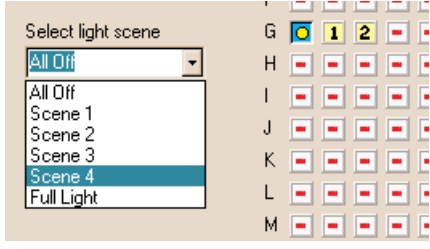
<p>Step 2 Select a Scenario function</p>	<p>Once a set of Dimmer controls is given, the Dimmer function "Dimmer scenario" is available.</p>
	
<p>Step 3</p>	<p>Now select which dimmers (lamps) are to be controlled by the scenario.</p> <p>The symbol  lit lamp, indicates an included dimmer. The symbol  indicates a dimmer not included. The symbols  show the Dimmer controls</p> <p>By selecting the lamp symbol in the table, its corresponding control channels are marked as well.</p> <p>Note: Various dimmers may be controlled by the same Scenario.</p> <p>Note: If several dimmers are to be controlled individually, with various scenarios, then different set of control channels must be set up.</p> <p>Note: only Dimmers of the same type (2*230W or 1x600W) are shown.</p>
	
	<p>Finally select the actual scenario to be performed.</p>

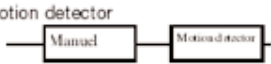
Combinations of Dimmer functions	On by	Off By
	<p>Manual and activation of the Motion detector</p>	<p>Either Manual or by elapse of the Motion detector time</p>
<p>The switch and the Motion detector are located in the same room. The Manual activation switches on or off the function of the Motion detector.</p>		
<p>Note: When controlled by Motion detector, the scenarios are still operational. The Motion detector also operates on the various light scenarios. The scenario "All off" will turn off the Manual switch to prevent the dimmer to turn on by the Motion-detector.</p> <p>To ensure correct operation of the Dimmer's, you should not operate the Dimmer-control addresses directly or through Master functions or logic, as this may disturb the function of the Dimmer when controlled by Motion detector.</p>		



2.3.4. Light functions

	<ul style="list-style-type: none"> • Function: Setting up various light control functions • Application: Automatic light functions depending of any combination including Motion/Proximity switch, Lux meters and Real-time switching, still having the possibility for Manual control. • Complex functions without the need for logic programming. • Channel efficient, all function integrated in the same object. • Manual control by Transmit on same address.
---	---

Description:

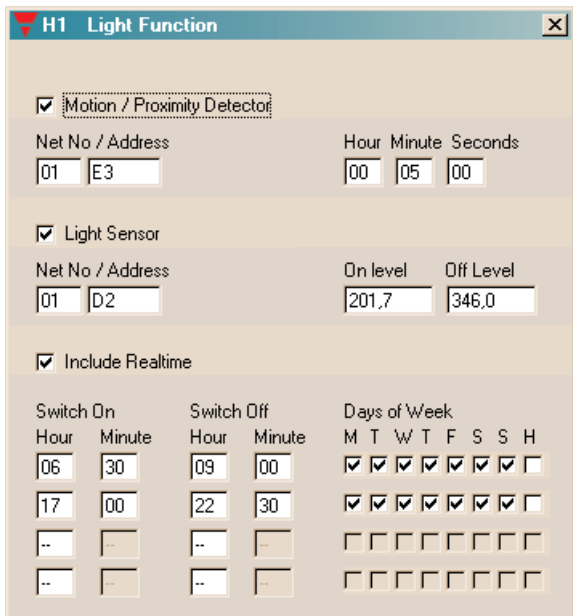
The Light function serves a number of selections to create various control options. The Light functions are pre-programmed and take up just one channel, and its functions are performed from the address input signal, to the output signal on the same address. The object may refer to other addresses to include information from a motion/Proximity Detector and a Light Sensor.

Parameter	Description
	
Motion/Proximity Detector	Select this to include a Motion detector in the Light Function When selected the entries to setup the Motion detector appear.
Net No / Address	Enter the address, from where the object are to fetch the Motion/Proximity Detector's input signal.
Hour,Minute,Seconds	The off-delay associated to the Motion detector
Light Sensor	Select this to include a Light sensor in the Light Function When selected the entries to setup the Light Sensor appears.
Net No / Address	Enter the address from where the object is to fetch the Light-sensors AnaLink value.
Include Real time clock	Select this to include Real-time switching When selected the entries to setup the Real-time switching appears.
Switch On/ Switch Off	The time of day where the on/off-switching is to take place
Days of week	Select the days of the week or holiday, where selected on/off switching takes place.

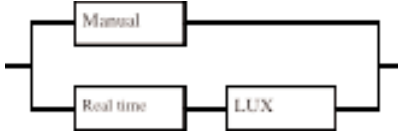
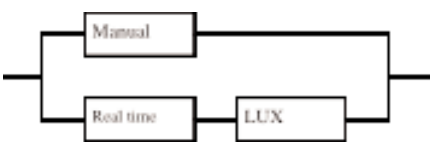
	Combinations of light functions	On by	Off By
1		Manual and activation of the Motion detector	Either Manual or by elapse of the Motion detector time
The switch and the Motion detector are located in the same room. The Manual activation switches on or off the function of the Motion detector.			
2		Manual or Automatic when the light intensity falls below the On-level	Either Manual or Automatic when the light intensity rises above the Off-level
Night light function. Eg. surveillance light for orientation during the night.			
3		Manual or Automatic by one of the Switch-On times	Either Manual or Automatic by one of the Switch-Off times
This function is equivalent to the Real-time clock object, Switching by time of day.			
4		Manual or Automatic when the light intensity falls below the On-level and activation of the Motion detector	Either Manual or by elapse of the Motion detector time or Automatic when the light intensity rises above the Off-level
Drive way light. Turns on the light in the driveway, when a motion is detected in the dark.			
5		Manual or Automatic when the light intensity falls below the On-level within the specified real time	Either Manual or Automatically when the light intensity rises above the Off-level or Automatically by one of the Switch-Off times
The Lux sensor is used to turn on the light. And the Real time turns it off. If the manually turned off, and it is still dark, the Real time may turn light on as well.			

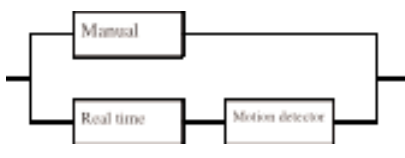
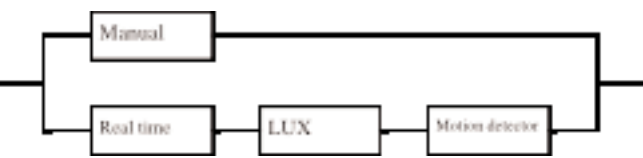
<p>Real-time and Motion</p> 	<p>Manual or Automatic when the Switch-On times and activation of the Motion detector</p>	<p>Either Manual or Automatic by one of the Switch-Off times or by elapse of the Motion detector time</p>	6
<p>The Motion detector only controls the light within a certain time interval.</p>			
<p>Real-time and Motion and Lux</p> 	<p>Manual or Automatic when the light intensity falls below the On-level and only when switched on by one of the Switch-On times or Automatic when the light intensity falls below the On-level and when switched off by one of the Switch-Off times, and activation of the Motion detector</p>	<p>Either Manual or Automatic when the light intensity rises above the Off-level or Automatic by one of the Switch-Off times or by elapse of the Motion detector time</p>	7
<p>Drive way light. Operates like 5, but turns on the light outside the specified switch on times when the motion detector is activated.</p>			

2.3.5. Temperature Control

	<ul style="list-style-type: none"> • Function: Setting up a fully functioned temperature regulation for a single room • Accurate PID regulation • Integrated economy operation • Heating and Cooling outputs • Energy save modes • Antifreeze function • Requires SHT-2-FUGA-DATALINK or SHT-2-OPUS-DATALINK display units to operate • Output for Heater • Output for Cooler • DatLink Synk. Control signal for Data-exchange between the Mastergenerator and the Display units. This is a common signal for all DataLink channeltypes.
---	--

Description:



The Temperature Control is designed for operation together with a Display unit, and forms an integrated solution for temperature regulation and adjustments for a single room.

Parameters



Parameter	Description
Heater Output address	Optional: Set up the output for the heater, this also selects the heater-function to operate. Not necessary when cooling only.
Cooler Output address	Optional: Set up the output for the Cooler, this also selects the cooler-function to operate. Not necessary when heating only.
Disable address	Optional: When an address is set up, then this address may be used to force the Heat- or Cool- output off.
Address of Outdoor Temperature	Optional: When Net-Id and Address is set, the temperature from this address is sent to the display-unit for readout.
Temperature Range	Setup the min and max temperature adjustment range. The display-unit returns the actual set-point temperature, which can only be set within these limits.
Energy save Temperature range	By selecting the Energy save, an additional temperature Range is to be set up. When the time falls within the real-time switch intervals, the temperature will regulate to the Econ temperature.
Antifreeze Enable Antifreeze temperature	Optional. When the Antifreeze function is selected, the temperature will be maintained at the set temperature, irrespective of whether the Disable address is active or the heat has been turned off via the Display unit.

2.3.6. Wireless Base

 	<ul style="list-style-type: none"> • Function: Setting up the Dupline wireless output modules • DataLink Synk. Control signal for data-exchange between the Mastergenerator and the Wireless Base unit
--	--

Description:

The Wireless Base is the joint-module, between the normal Dupline network and the Dupline Wireless modules. The set up of the wireless base is needed when using wireless output modules. This channel object feeds information of which outputs the Wireless Base has to keep updated.

Parameters

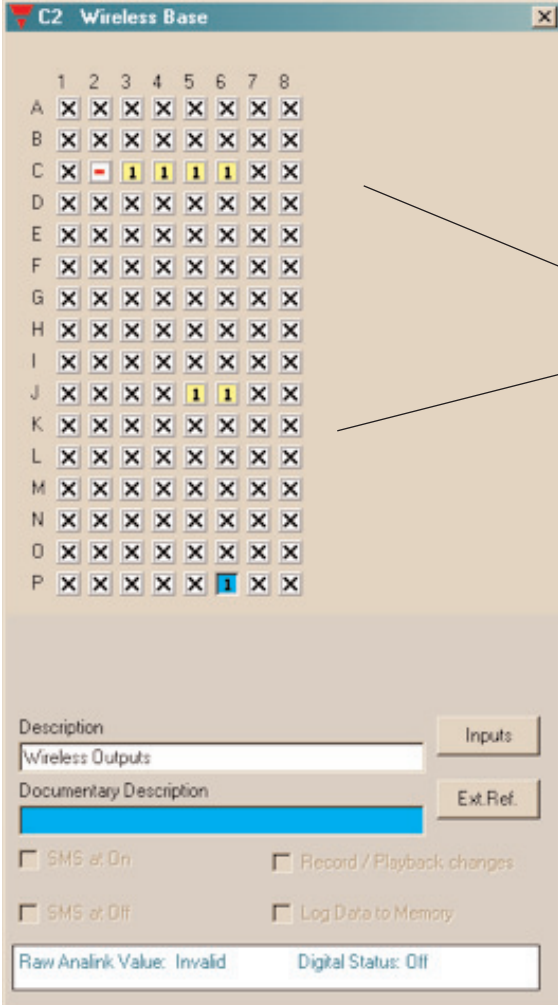

Select addresses for the wireless output modules

2.4. Alarm functions

2.4.1. Overview

This chapter will assist you in using the four different Dupline alarm systems:

1. ISA-alarm (chapter 2.4.3)
This general alarm system developed acc. to ISA specifications is very flexible and has formed the basis of the development of the other alarms systems. Application areas include temperature- and level control as well as plants requiring ordinary alarm functions.
2. Smoke alarm (chapter 2.4.4.)
The primary purpose of this alarm system is the connection of the Dupline smoke detector. Of course, other smoke detectors can also be used if they provide a Normally closed or Normally open contact. In this case, the connection to the Dupline system can take place through a digital input.
3. Intruder alarm (chapter 2.4.5)
This system provides objects which allow monitoring of input signals for the intruder alarm. The inputs can be either floating or non-floating contacts connected to the system through digital Dupline inputs.
4. Water alarm (chapter 2.4.6)
The Water alarm was developed as a separate system intended for the connection of water stop sensors.

The alarm systems differ in the following ways:

- In the armouring (manual/door lock)
- In the type of alarm resetting (Acknowledgement/Reset)
- In the way of alarming and
- In the time characteristics

The individual systems are described in detail in the following chapters. The object "Common siren" can be used in all system to allow a centralized alarm.

2.4.2. General features

2.4.2.1. In-/output on one channel

The alarm systems benefit more than any objects from the capability of Dupline to differ between in- and outputs on the same address. Thereby it is possible to use a Normally open contact to reset the system and subsequently switch it in and out alternately.

The user should therefore not be surprised when:

- a channel is activated without an input being activated or
- a channel is not activated although an input is activated

2.4.2.2. Master functions

Alarm objects can generally not be affected by master functions.

2.4.3. ISA Alarm

	<ul style="list-style-type: none"> • Function: General alarm system with inclusion of Passive detector, Active detector, Acknowledgement, Reset, Lamp test and Alarm siren • Application: Monitoring of contacts and other alarm sources. • Select with mouse ("ISA alarm") or short-cut key "A"
---	---

Description

The purpose of the ISA-Alarm is to serve as a general alarm system acc. to the ISA specifications. The system supports two operation modes:

1. **Standard:** An alarm is reset ("Reset") and switched on again manually by push-button.
2. **Auto reset:** An alarm is reset and switched on again automatically after acknowledgement and removal of the cause of alarm (Normal position of the alarm contacts).

Alarm contacts are generally included in the system through the objects "Passive detector" and "Active detector". The alarm system is switched on for the first time after downloading of the application when all alarm contacts are in off-position or the Reset button is activated. The alarm is released when one or several alarm contacts are activated. The system actuates the activated alarm contact approx. every second and switches the alarm output on for the set duration.

When the Acknowledgement button has been actuated in the "Standard" operation mode, the alarm contacts switch from flashing to continuous operation and the alarm output is switched off. At this point of time, renewed actuation of an alarm contact does not trigger off an alarm. Subsequent actuation of the Reset button switches the alarm contact off and releases the alarm system.





If the Reset button is actuated **before** the Acknowledgement button, the system will also switch off the alarm output, but the alarm contacts will continue to flash. A new alarm is caused by renewed activation of an alarm contact.

In the operation mode "Auto reset", the alarm system is restarted after acknowledgement and with alarm contacts in off-position.

The status of the alarm contacts can easily be displayed, eg on a panel. This only requires that the output channels are coded for the same addresses as the alarm contacts. The functionality of the lamps can then be tested by means of the object "Lamp test".

For giving out alarms, the object "Common siren" can also be used. Further details can be found in chapter 2.4.7.

The various ISA objects are selected under "Function":

- | | | |
|-------------------|---|---|
| Passive detector: |  | Normally open input. This object makes it possible to include passive detectors. When the contact is activated and a "1"-Signal consequently transmitted on the Dupline bus, an alarm is started. |
| Active detector: |  | Normally closed input. This object makes it possible to include active detectors. When the contact is activated and a "0"-Signal consequently transmitted on the Dupline bus, an alarm is started. |
| Acknowledgement: |  | This object makes it possible to include acknowledgement buttons. Upon actuation of an acknowledgement button, the alarm output is reset and the alarm source indication prepared for the resetting (changing from flashing to continuous operation). |
| Reset: |  | This object is only needed in the operation mode "Standard" and makes it possible to include a button for resetting the alarm and restarting the system. This requires prior acknowledgement of the alarm. |

Note: This object must always be configured.

If a contact is activated during resetting, the system triggers off a new alarm
 When this object is configured, the operation mode "Standard" is automatically selected.

Lamp test:  This object makes it possible to test the function of lamps indicating the status of the alarm contacts. All alarm channels are activated upon actuation of the lamp test button.

Alarm siren:  The alarm siren indicates the occurrence of an alarm. The channel configured for this object can be used for alarm output on a random number of output modules. It usually activates a relay output switching a siren.

Parameters:

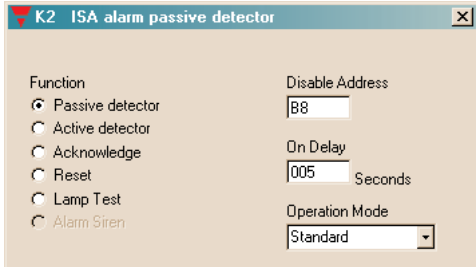
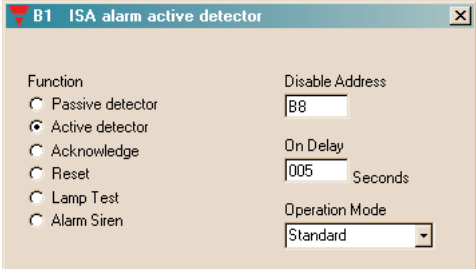
Parameter	Description
Operation mode	<p>Standard: This setting means that activation of the alarm system takes place upon prior release by the reset button. This entails that the object "Reset" must be configured.</p> <p>Auto reset: With this setting, the system activates itself automatically upon acknowledgement, when all passive and active detectors are in their "normal" position (in which they do not trigger off alarms)</p> <p>Note: Operation mode can be selected for any object of the ISA alarm - but applies to the entire system. If the object "Reset" is selected to include a reset button, the system assumes that the operation mode "Standard" is to be selected. Simultaneously, the option operation mode is deactivated and can only be re-activated by unclicking the object "Reset". If "Auto reset" is selected, the system prevents configuration of the "Reset" object.</p>
Passive detector	
Disable address	Enter an address or a flag whose activation ("1"-signal) will leave out the Passive detector function of the monitoring system whereby it cannot trigger off any further alarms.
On-delay	Enter a time value in seconds (0..255) must persist in order to activate the alarm.
Active detector	
Disable address	Enter an address or a flag whose activation ("1"-signal) will leave out the Passive detector function of the monitoring system whereby it cannot trigger off any further alarms.

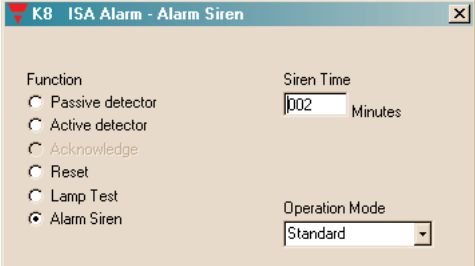
On-delay	Enter a time value in seconds (0..255) for which the alarm signal must persist in order to activate the alarm.
Acknowledge	No configuration possibilities.
Reset	No configuration possibilities.
Lamp test	No configuration possibilities.
Alarm siren	
Siren time	<p>This setting determines for how long the alarm output is to remain activated in case of alarm. The value can be between 0 and 60 min.</p> <p>Note: With the Minus-key (-), the time can be set to an indefinite time. This is indicated by “»»»”.</p>

Time characteristics

Operation mode “Standard”

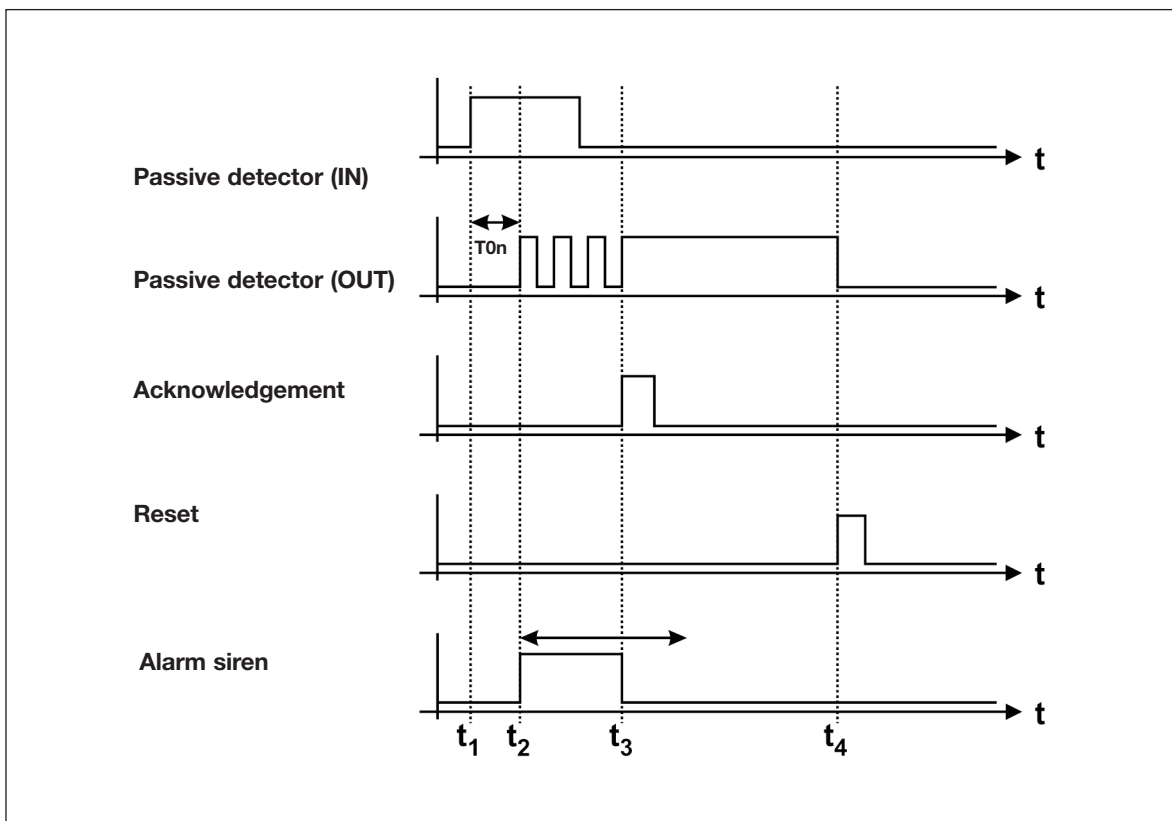

The above illustration shows the normal sequence and reset of an alarm in the operation mode “Standard”:

- t₁: When all contacts are in off-position, the Mastergenerator alerts the alarm system automatically upon loading of the application.
- t₂: After elapse of on delay T_{ON} , the Mastergenerator activates the alarm siren and causes the output of the source channel to flash.
- t₃: By activation of the acknowledgement button, the Mastergenerator switches the alarm siren off (provided that the siren time has not elapsed) and transfers the alarm source indication into a continuous signal.
- t₄: By activation of the reset button, the alarm source indication turns off and the system is alert again.

Operation mode “Auto reset”

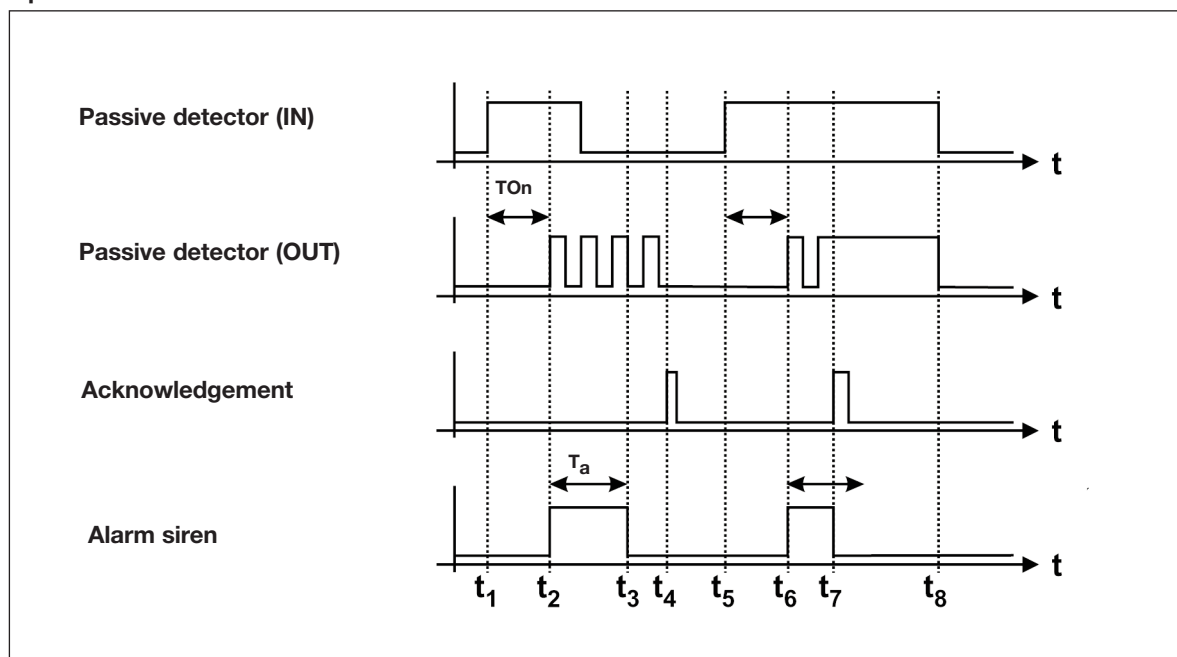

The above illustration shows the normal sequence and reset of an alarm in the operation mode “Auto reset”:

- t₁: When all contacts are in off-position, the Mastergenerator alerts the alarm system automatically upon loading of the application.
If a contact is subsequently activated, initially nothing will happen because of entered on delay T_{ON} .
- t₂: After elapse of on delay T_{ON} , the Mastergenerator activates the alarm siren and causes the output of the source channel to flash.
- t₃: After elapse of the siren time T_A and reset of the alarm contact, the Mastergenerator switches the alarm siren off.
- t₄: Acknowledgement deactivates the Normally open output, and the system at once brings itself in the alert state again.
- t₅/t₆: As t₁/t₂.
- t₇: In spite of the acknowledgement of the alarm, the flashing source indication changes to continuous operation, because the alarm source is still activated at this point of time. Since the siren time has not yet elapsed, the alarm siren turns off.
- t₈: Only when the alarm source switches off, is the source indication also reset and the alarm system in the alert state again.

Application Example

Task: In a chemical factory, eight laboratories are to be provided with alarm switches. Upon activation of an alarm button, the fire staff of the factory is informed via a siren. When the fire staff has acknowledged the alarm, they go to the lab where the alarm was started.

Solution: The alarm switches are coded for channels A1 to A8. The source of the alarm is indicated on a panel whose LED is activated via a mimic display. The addresses correspond to those of the alarm contacts. The fire staff uses a button coded for address B1 to acknowledge the alarms. The alarm is reset through a reset button coded for address B2. The alarm is sounded by means of a horn activated through a relay output module coded for address B4.

Object	Function	Channel
In-/outputs		
Alarm switch	Alarm contact	A1..A8
Push-button input	Acknowledgement	B1
Push-button input	Reset	B2
Push-button input	Lamp test	B3
Semiconductor output	LED for source indication on a panel	A1..A8
Relay output	Alarm siren	B4
Configuration		
ISA alarm: Passive detector	Alarm sources	A1.. A8
ISA alarm: Acknowledgement	Alarm acknowledgement	B1
ISA alarm: Reset	Alarm reset	B2
ISA alarm: Lamp test	Activation of all LEDs on the panel	B3
ISA alarm: Alarm siren	Alarm sounding	B4

2.4.4. Smoke Alarm

	<ul style="list-style-type: none"> • Function: Fire alarm system including Passive detector, Active detector, Reset, Alarm Siren and Alarm signal • Application: Wiring of smoke/fire indicators to an alarm system • Select with mouse (“Smoke alarm”) or short-cut key “S”
---	---

Description

The purpose of the Smoke Alarm is an alarm system consisting of smoke and fire indicators integrated as Passive or Active detectors. The wiring makes it possible to replace conventional fire alarm systems.

Smoke detectors are generally included in the system through the objects “Passive detector” or “Active detector”. The alarm system is automatically alert after elapse of the Reset delay (set with the Reset object), when the Configuration software has been downloaded or the Mastergenerator has been switched on. The Reset output switches on within this time.

An alarm is triggered off when one or several alarm contacts are activated for more than 10 s. The channel for the activated alarm contacts (alarm source indication) as well as the alarm output start to flash approx. every second. By subsequent activation of the reset key, the Mastergenerator switches the channel out of the system. If contacts are still activated, another alarm is triggered off after elapse of the reset delay.





Note: Configuration of the object “Reset” is absolutely necessary to ensure correct function.

The status of the alarm contacts can be shown in a simple way on a panel. All that is needed for this purpose is that the output channels are coded to the addresses of the alarm contacts.

The “Silent Alarm Signal” is intended for sending an alarm to a monitoring centre, but also suitable for SMS messages.

For alarm purposes, the object Common Siren can also be used. Details can be found in the section describing The alarm siren/Common siren.

The various smoke alarm objects are set under “Channel function”:

Passive detector:		Normally open input. This object makes it possible to include passive detectors. When the contact is activated and a “1”-Signal consequently transmitted on the Dupline bus, an alarm is started.
Active detector:		Normally closed input. This object makes it possible to include active detectors. When the contact is activated and a “0”-Signal consequently transmitted on the Dupline bus, an alarm is started.
Reset:		<p>This object makes it possible to include a button to reset the alarm and restart the system.</p> <p>If a contact is activated during reset, a new alarm is started after elapse of the reset delay.</p> <p>Note: This object must be configured in order to achieve correct function of the smoke alarm system.</p>
Alarm siren:		<p>The siren indicates that an alarm has occurred. The channel configured with this object can be used to output the alarm on any output modules. It usually activates a relay output through which a siren is switched.</p> <p>Note: The alarm output basically flashes.</p>
Silent Alarm signal:		When an alarm occurs, a channel configured with this object is activated for 10 s and can thus be used to activate a telephone or GSM-modem.

Parameters:

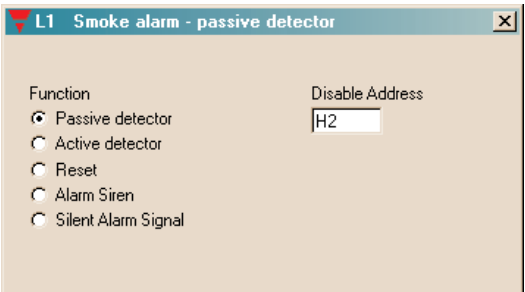
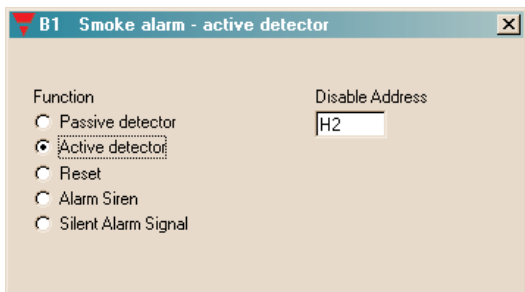
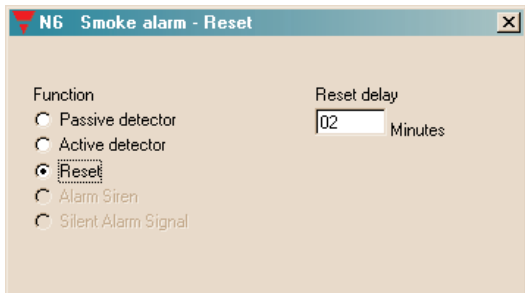
Parameter	Description
Passive detector	
Disable address	<p>Enter an address or a flag whose activation (“1”-signal) will leave out the Passive detector function of the monitoring system whereby it cannot trigger off any further alarms.</p>
Active detector	
Disable address	<p>Enter an address or a flag whose activation (“1”-signal) will leave out the Active detector function of the monitoring system whereby it cannot trigger off any further alarms.</p>
Reset	
Reset delay	<p>The delay after which the system becomes alert or an alarm is suppressed upon activation of the reset button. This function can be used to ensure that the measuring chambers are completely emptied of smoke.</p> <p>This time is also used in connection with download of the software and switching on of the channel generator.</p>

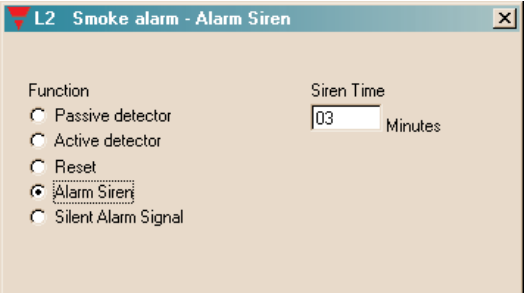
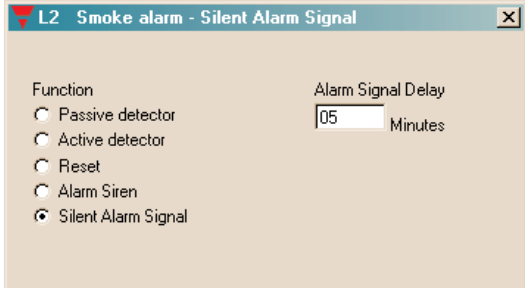
Parameter	Description
Alarm siren	
Siren time	<p>With this setting, you determine the duration of the activation of the alarm output upon the occurrence of an alarm. The value can lie between 0 and 60 min. The entered value is automatically adopted by the Common Siren.</p>
Alarm signal	
Alarm signal delay	<p>With this setting, you determine the time to elapse after switching on of the alarm siren till the alarm signal is activated. The value can lie between 0 and 10 min.</p>

Time characteristics

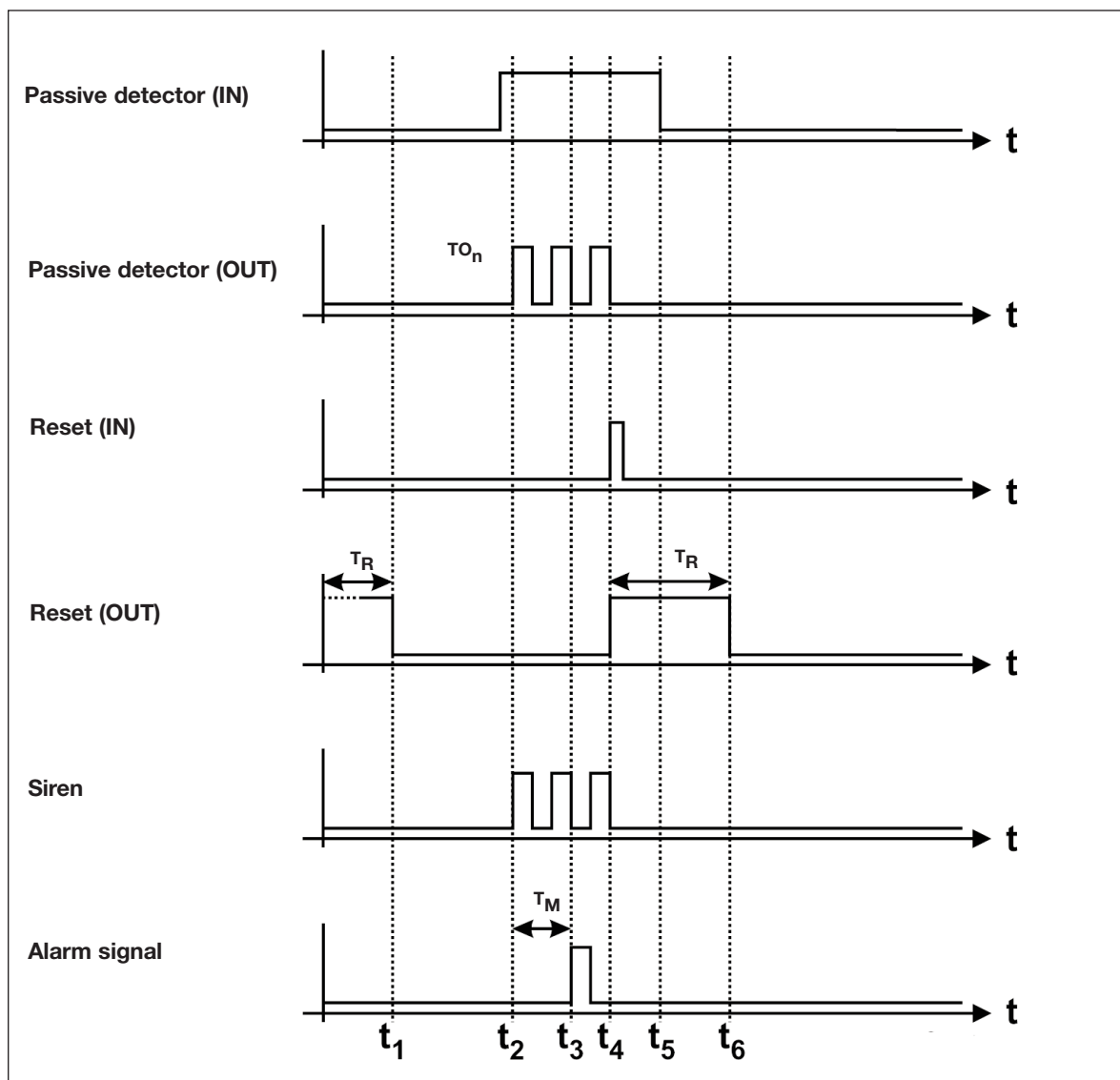

The above illustration shows the normal sequence and reset of an alarm:

- t₁: When power supply is connected, the system becomes alert after elapse of the set reset delay T_R , indicated by reset of the reset output.
- t₂: After a short delay (approx. 3 s) after the occurrence of a fire (activation of the Passive detector), the alarm is started. This takes place by the alarm siren flashing and by output of the Passive detector channel, whereby the alarm source is indicated.
- t₃: The channel generator activates the alarm signal channel after elapse of the set alarm signal delay T_M .
- t₄: By activation of the reset button, the alarm siren and the alarm source indication are reset, although the alarm source (Passive detector) is activated as before. The reason is that the Mastergenerator ignores all alarm sources during the reset delay.
- t₅: By removing the smoke from the smoke detector, the Passive detector opens again and deactivates the alarm channel.
- t₆: After elapse of the reset delay, the system becomes alert again, and the reset output is reset.

Application Example

Task: In a residential building, eight rooms are to be equipped with smoke detectors. When an alarm occurs, a siren switches on and the fire authorities are notified.

Solution: The alarm channels of the smoke detector are assigned to channels C1 to C8. The alarm source is indicated on a panel whose LED is activated by mimic display. The addresses correspond to those of the alarm contacts. The alarm is sounded through a horn which is activated through address D2 of a relay module. The alarm is reset again by a push-button on address B1.

2.4.5. Intruder Alarm

	<ul style="list-style-type: none"> • Function: Intruder alarm system including Passive/Active detector contacts, Toggle switch functions, Motion detectors, Manual and Door-lock Armouring, Code lock Armouring, Alarm siren and Alarm signal • Application: Wiring of intruder detector contacts to an alarm system • Select with mouse ("Intruder alarm") or short-cut key "I"
---	---

Description

The purpose of the Intruder Alarm is an alarm system consisting of various contacts integrated as Passive or Active detectors.

Apart from the contacts represented by their own objects (Passive and Active detector), it is also possible to include toggle switch functions and motion detectors which have already been configured. This is done directly when setting the parameters for these objects.

A system which is enabled will then start an alarm when one or several alarm contacts have been activated. The channel for the activated alarm channels (as alarm source indication) as well as the alarm output start to flash after the set time delay. By subsequent activation of the Manual armouring, the Door-lock armouring or Code lock armouring, the Mastergenerator switches the channel out of the system and switches the alarm output off.

If an alarm is not acknowledged before elapse of the alarm signal delay, the system automatically becomes alert again.

Note: For a minimum alarmsystem to operate correctly, according to Human behavior, the following objects must be included:

- a) means to start/stop the alarm, either "Manual armouring", "Door-lock armouring" or "Code lock armouring"
- b) at least one alarm detector.
- c) the "Silent Alarm Signal"



Either the "Door Lock armouring" or "Code Lock Armouring" may be combined with the "Manual armouring". The Door/Code Lock has a priority over the Manual armouring. The Manual armouring allows alarm zones, whereas the Door/Code Lock always include ALL alarm detectors.

The status of the alarm detectors can be shown in a simple way on a panel. All that is needed for this purpose is that the output channels are coded to the addresses of the alarm contacts.

The object "Silent Alarm signal" is primarily intended for signalling an alarm-central, but equally important is, that when this signal has been passed, the alarm-system resets the detected alarms, and the surveillance cycle on the detectors is restarted.

The object Common Siren may be used as well.

The various Intruder alarm objects are selected under "Channel function":

- | | | |
|--------------------------|---|--|
| Passive detector: |  | This object makes it possible to control windows, doors, etc. with Passive detector. If the contact is activated and a "1"-Signal consequently transmitted on the Dupline bus, an alarm is started. |
| Active detector: |  | This object makes it possible to control windows, doors, etc. with Active detector. When the contact is activated and a "0"-Signal consequently transmitted on the Dupline bus, an alarm is started. |
| Manual armouring: |  | The Manual armouring operates like a toggleswitch, and is used to start and stop the Intruder alarm system. The Manual armouring allows the alarm detectors to react upon their respective disable addresses, whereby more alarm zones can be created. |

- Door lock armouring:**  The Door Lock armoring operates like a push-button, and when activated the Intruder alarm system is started. The Door Lock armoring must be kept active as long as the alarm system should be running. The Door Lock armoring prevents the alarm-detectors to react upon their respective disable addresses. The Door Lock armoring thus activates all alarm zones.
- Code lock armouring:**  The Code Lock armoring operates like a toggle switch and is an alternative way to start and stop the Intruder alarm system. The Code Lock armoring also prevents the alarm-detectors to react upon their respective disable addresses. Like the Door Lock, the Code Lock activates all alarm zones.

Note: Either Code Lock or Door Lock may be used at one time.
- Alarm siren:**  The Alarm siren is used for the local audio alarm signal. The Alarm siren, also supports 'Visual' effects, as a selection of addresses may be set up to flash while the siren is on. This feature will further stress any intruder
- Silent Alarm signal:**  The “Silent Alarm signal” is primarily intended for sending an alarm signal to a security centre. Equally important is, that when this signal has been sent, the Intruder alarm system resets the detected alarms, and the surveillance cycle on the detectors is restarted.
- Warning signal:**  This is an output for a local buzzer or lamp. When the alarm is armed, the Warning Signal will start pulsating slowly and increase pulse-speed until alarm is armed. For this function to operate properly, the armoring delay should be set to a minimum of 10 seconds.
- Toggle switch**  Has an option for sending signals to Intruder alarm. See the chapter **function:** describing the Toggle Switch function.
- Motion detector:**  The motion detector can also be integrated in the intruder alarm. See the chapter describing the Motion detector.

Parameters

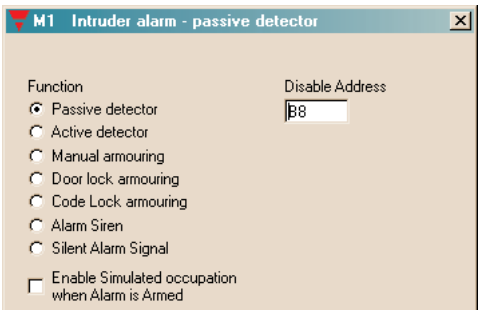
Parameter	Description
Passive detector	
Disable address	Enter an address or a flag whose activation (“1”-signal) will prevent the detector to cause an alarm. This feature may be used to have more alarm zones, when the alarm is armoured by the Manual Armoring.

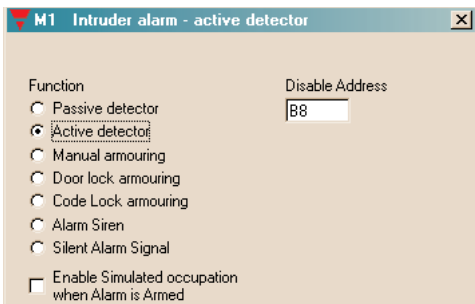
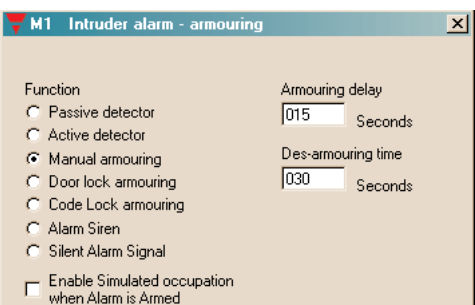
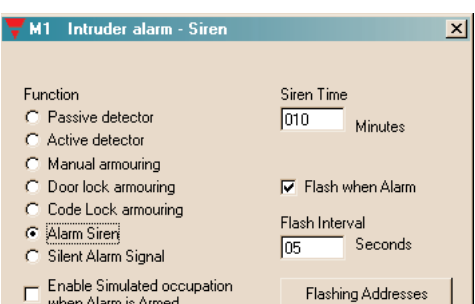
Parameter	Description
Active detector	
Disable address	<p>Enter an address or a flag whose activation ("1"-signal) will prevent the detector to cause an alarm. This feature may be used to have more alarm zones, when the alarm is armoured by the Manual Armouring.</p>
Manual armouring Door-lock armouring Code lock armouring	
Armouring delay	<p>Determines the delay, from start of the alarm, until the the alarm surveillance becomes active. The delay is used to cope with the situation where a detector is activated, while the alarm is switched on.</p> <p>Eg. The Alarm switch for start and stop is located in the hall, and the frontdoor is equipped with an alarmdetector. Time should be set long enough, that a person may start the alarm and leave through the door, without causing an alarm.</p>
De-armouring delay	<p>Determines how many seconds may pass from an alarm has occured until the alarm siren is activated. The time is used to cope with the situation, where the rightfull owner actually causes an alarm, by entry.</p> <p>Eg. The Alarm switch for start and stop is located in the hall, and the frontdoor is equipped with an alarm detector. Time should be set long enough, that a person may open the door, walk across the hall, and stop the alarm.</p>
Alarm siren	
Siren time	<p>Enter for how long time the alarm output is to remain activated when an alarm occurs. It is limited from 0 and 60 min.</p> <p>The entered value is automatically adopted by the Common siren.</p>

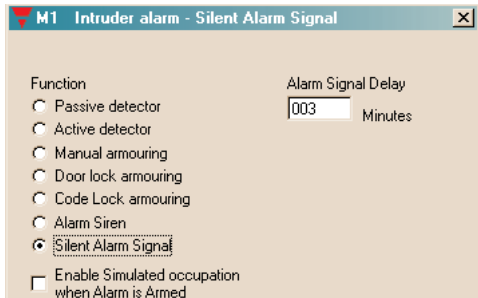
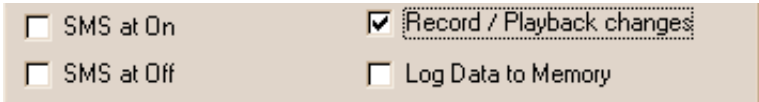
Parameter	Description
Flash when Alarm	Select this to setup the 'Visual' alarm effects. This allows you to select which channels are to flash while the Siren is activated. Only when selected, the "Flash interval" entry and the "Flash addresses" button are visible.
Flash Interval	Here you can enter the switch on/off time span of the flashing alarm signals. The option "Flash when Alarm" must be switched on. The value can lie between 0 and 60 s. Please note that flash intervals below 2 seconds may turn out inaccurately because of the cycle time. When the value 0 is entered, flashing takes place at the fastest possible rate.
Flashing Channels	Click on this button to open the address matrix to select the addresses which are to flash upon an alarm. Only shown when "Flash when alarm" is selected.
Alarm signal	
Alarm signal delay	With this setting you can determine the time which is to elapse from the alarm siren is activated till the alarm signal is activated. The value can lie between 0 and 10 min.
Enable Simulated occupation when Alarm is armed	Select this option to make an automatic Playback of the addresses selected for Record/Playback.
Selection of Record/Playback	
	<p>Recording</p> <p>The selection of Record/Playback is available on most of the objects. The recording only takes place when the Intruder-alarm is in active. When selected for Record / Playback, the object's output status will be recorded at every 3 minutes intervals. The recording operates like an endless 'tape-loop' running over one week. The recorded data are stored permanently once every 24 hours just before midnight, to continuously renew the record-history.</p> <p>Playback takes place, when the Intruder-alarm is started and the "Enable Simulated occupation" is selected. The recorded data are used to activate the objects in the same sequence as recorded.</p> <p>If no records have been made for a certain time period while playback, the objects will keep their last set on/off status.</p> <p>The Playback activation of the objects, is a set – reset operation sent to the objects, which is similar to a normal Manual activation.</p> <p>When turning off the intruder alarm, the last set status will still remain on the objects.</p>

Time characteristics

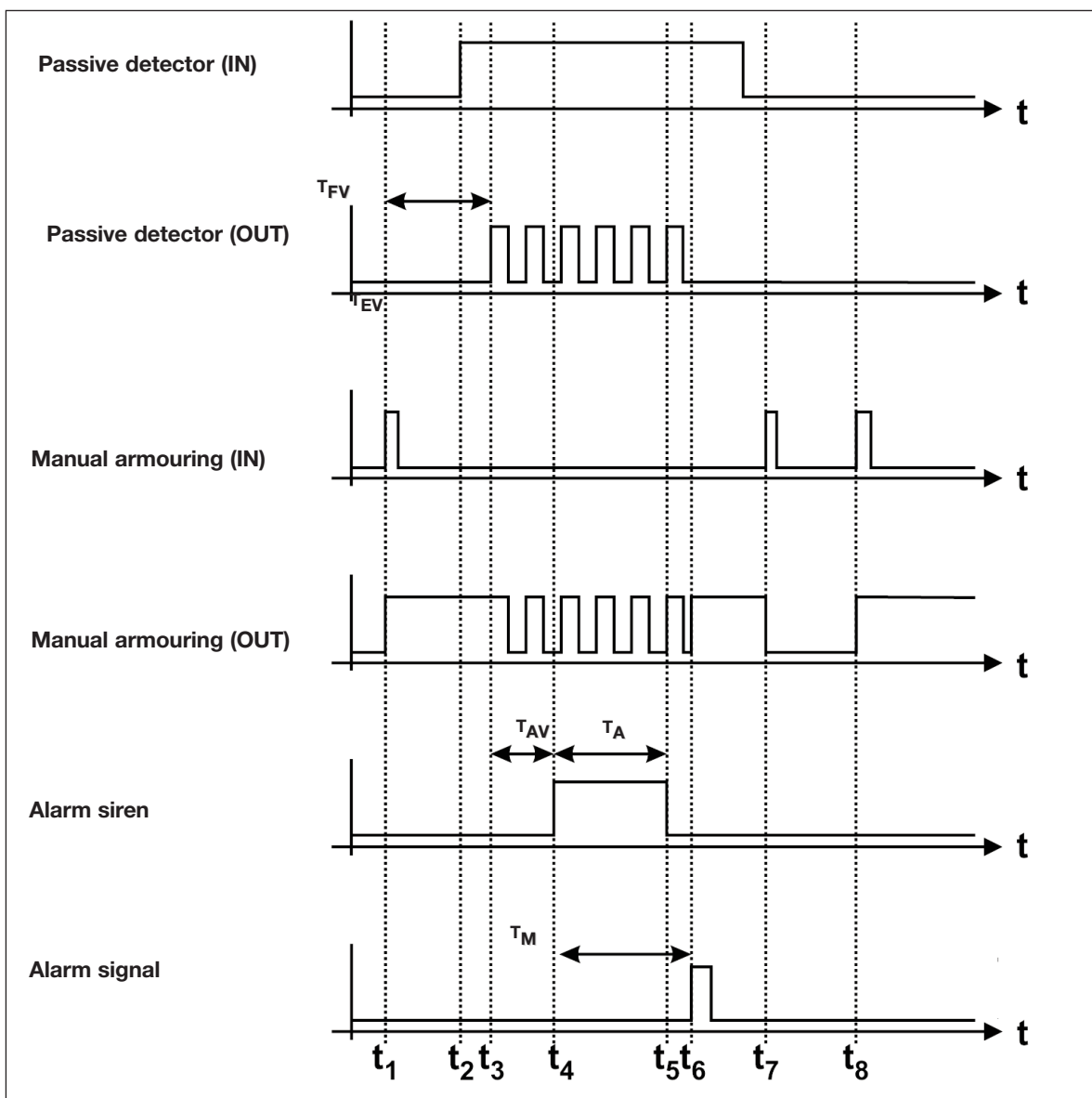

The above illustration shows the normal sequence of an alarm using manual armouring to start and stop the alarm:

t_1 : When the Mastergenerator is switched on, the alarm system becomes alert through activation (once) of the Manual Armouring function.

t_2 : An alarm contact is activated, eg by the opening of a secured port. Since the armouring delay T_{FV} in this example has not yet elapsed, nothing happens at first.

t_3 : After elapse of the armouring delay T_{FV} , the alarm is started, ie both the channel of the alarm contact and that of the Manual Armouring start to flash.

t_4 : After elapse of the de-armouring delay T_{AV} , the Mastergenerator activates the alarm siren.

t_5 : After elapse of the siren time T_A , the alarm siren channel is deactivated. The flashing of the alarm contact and the Manual Armouring output continues.

t_6 : After elapse of the alarm signal delay T_M set at the object "Alarm signal", the channel is briefly activated. At the same time, the alarm contact is continuously switched off and the Manual Armouring output continuously switched on.

t_7 : Activation of the Manual Armouring will acknowledge the alarm, and the Manual Armouring output will be reset.

t_8 : Activating the Manual Armouring once more will bring the system back into the alert state - after the armouring delay T_{FV} .

Application Example

Task: In a residential building, eight rooms are to be equipped with window and door contacts. All light switches as well as two motion detectors are to be included in the system. When an alarm occurs, a siren switches on and the police is informed via a telephone modem. A panel shows the source of the alarm. The system should moreover make it possible to disable the alarm contacts on each floor.

Solution: The alarm contacts are grouped room-wise (switched in series). Each room is assigned to a NO contact within the range E1..E8. The source of the alarm is shown on a panel whose LED is activated via a mimic display. The addresses correspond to those of the alarm contacts. The alarm is sounded through a horn, which is activated via a relay on address F3. The alarm can be turned on and off by the Manual Armouring function on F1 in the input range or through the Code Lock Armouring function at the entrance door. Disabling of floors is performed with two switches.

2.4.6. Water Alarm

	<ul style="list-style-type: none"> • Function: Water alarm system including Passive detector, Active detector, Reset, Siren and Alarm signal • Application: Wiring of water indicators, eg the water stop sensor, to an alarm system • Select with mouse ("Water alarm") or short-cut key "W"
---	--

Description

The purpose of the Water Alarm is an alarm system consisting of water sensors integrated as Passive or Active detector. The wiring makes it possible to replace conventional water alarm systems.

Water detectors are generally included in the system through the objects "Passive detector" or "Active detector". The alarm system is automatically alerted after elapse of the Reset delay (set with the reset object), when the Configuration software has been downloaded or the Mastergenerator has been switched on. The Reset output switches on within this time.

An alarm is triggered off when one or several alarm contacts are activated for more than 10 s. The system steps through the activated alarm contacts (as alarm indication) as well as the alarm output approx. every second. The alarm siren flashes with a pulse-pause ratio of approx. 3 s/57 s. By subsequent activation of the reset key, the Mastergenerator resets the stepping through of the alarm contacts and the alarm output. If contacts are still activated, another alarm is triggered off after elapse of the reset delay.

Note: Configuration of the object "Reset" is absolutely necessary to ensure the correct function.

The status of the alarm contacts can be shown in a simple way on a panel. All that is needed for this purpose is that the output channels are coded to the addresses of the alarm contacts.

The "Silent Alarm Signal" is intended for sending an alarm to a monitoring centre. Also suitable for sending an SMS.

For alarm purposes, the object Common Siren can also be used. Details can be found in the chapter describing the alarm siren/Common siren.

The various water alarm objects are selected under "Channel function":

Passive detector:  Normally open input. This object makes it possible to include passive detectors. When the contact is activated and a "1"-Signal consequently transmitted on the Dupline bus, an alarm is started.

Active detector:  Normally closed input. This object makes it possible to include active detectors. When the contact is activated and a "0"-Signal consequently transmitted on the Dupline bus, an alarm is started.

Reset:  This object makes it possible to include a button to reset the alarm and restart the system.
If a contact is activated during reset, a new alarm is started after elapse of the Reset delay.

Note: This object must be configured in order to achieve correct function of the water alarm system.

Alarm siren:  The alarm siren indicates the occurrence of an alarm. The channel configured for this object can be used for alarm output on any output modules. It usually activates a relay output switching a siren.

In case of alarm, this output flashes with an on-time of approx. 3 s and an off-time of approx. 57 s.

Silent Alarm signal:  When an alarm occurs, a channel configured for this object is activated for 10 s and can thus be used to activate a telephone or GSM modem.

Parameters

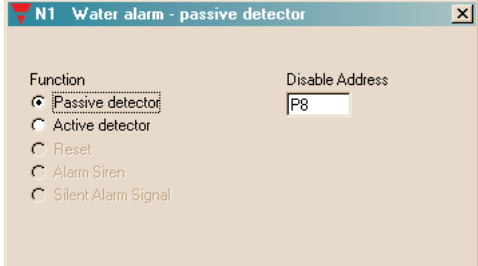
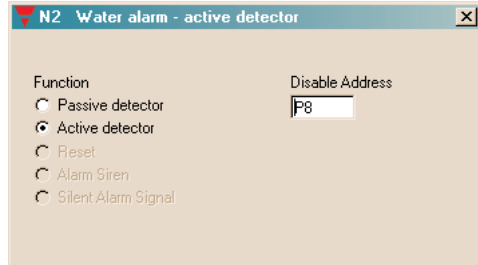
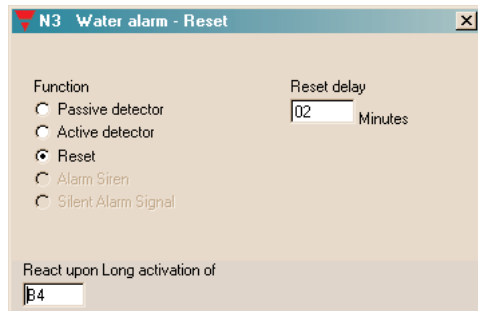
Parameter	Description
Passive detector	
Disable address	Enter an address or a flag whose activation ("1"-signal) will leave out the Passive detector function of the monitoring system whereby it cannot trigger off any further alarms.
Active detector	
Disable address	Enter an address or a flag whose activation ("1"-signal) will leave out the Active detector function of the monitoring system whereby it cannot trigger off any further alarms.
Reset	
Reset delay	The delay after which the system becomes alert or is to remain switched off upon activation of the reset button. The reset delay can be from 2 and 10 min.

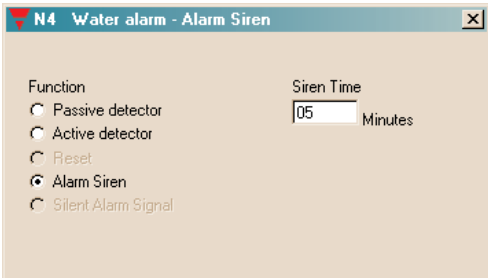
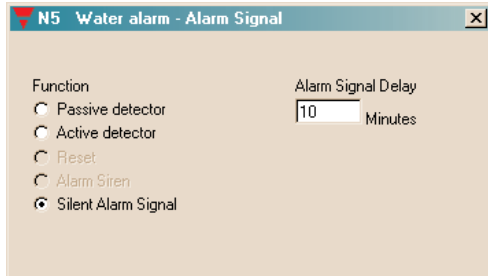
Parameter	Description
Alarm siren	
Siren time	<p>With this setting, you determine the duration of the activation of the alarm output upon the occurrence of an alarm. The value can lie between 0 and 60 min. The entered value is automatically adopted by the Common Siren.</p>
Alarm signal	
Alarm signal delay	<p>With this setting, you determine the time to elapse after switching on the alarm siren till the alarm signal is activated. The value can lie between 0 and 10 min.</p>

Time characteristics

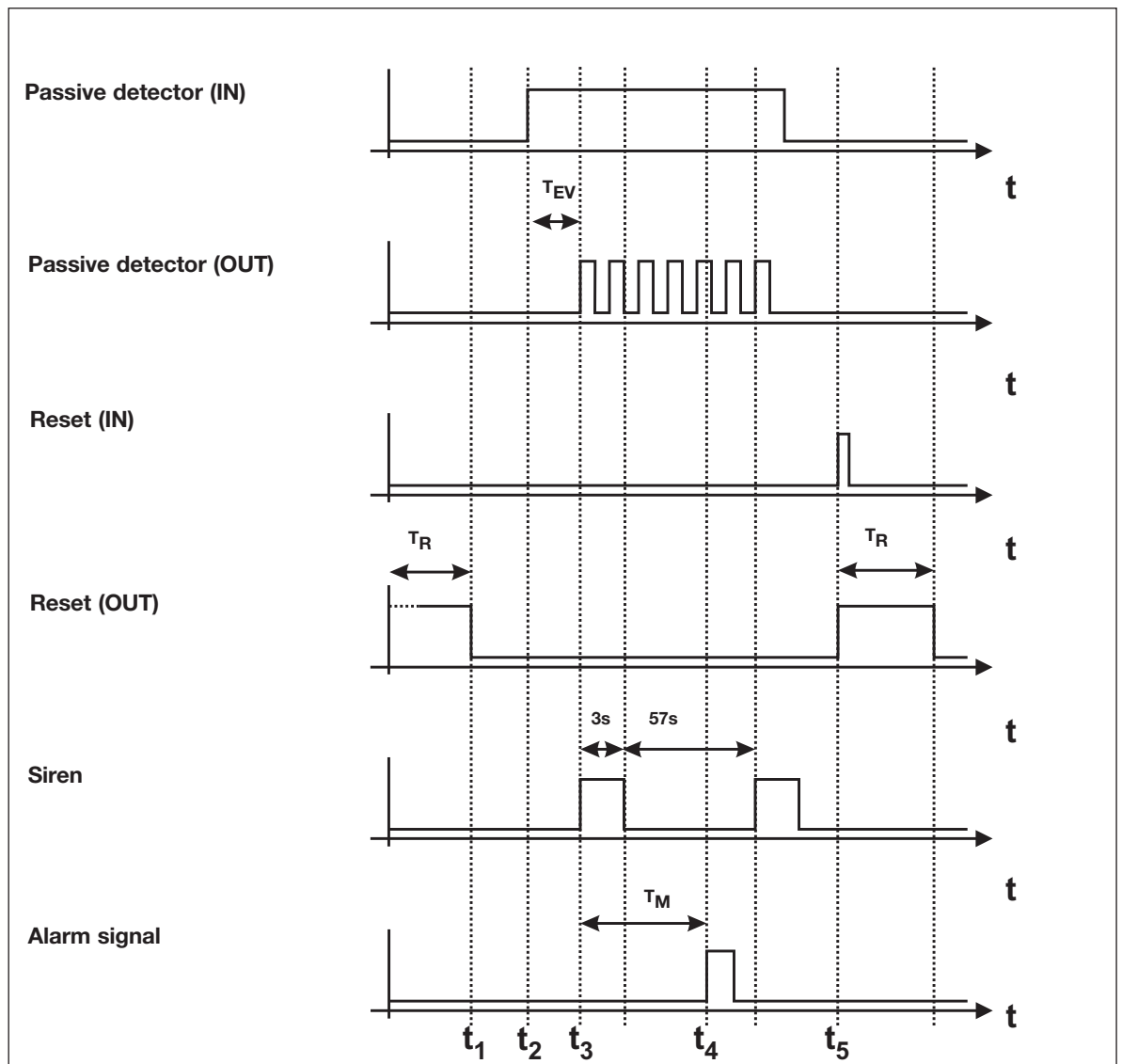

The above illustration shows the normal sequence and reset of an alarm:

- t_1 : When power supply is connected, the system becomes alert after elapse of the set reset delay T_R , indicated by reset of the reset output.
- t_2 : An alarm contact is activated. This starts the switch on delay T_{EV} , which can run for 3 - 11 s depending on the number of channels.
- t_3 : Upon elapse of the switch-on delay T_{EV} , the Mastergenerator causes the output of the activated contact as well as the alarm siren to flash. The alarm siren is then switched on for approx. 3 s and switched off for approx. 57 s.
- t_4 : Upon elapse of the alarm signal delay T_M , the alarm signal is briefly activated.
- t_5 : Activation of the reset button starts the reset delay and the siren is switched off.

Application Example

Task: In a residential building, eight rooms are to be protected against water damage. When an alarm occurs, a siren switches on and the house owner is informed by means of an SMS-message. The room in question should be recognizable on a panel.

Solution: The alarm channels of the water stop sensors are assigned to channels G1 to G8. The alarm source is indicated on a panel, whose LED is activated by a mimic display. The addresses correspond to those of the alarm contacts. The alarm is sounded through a horn which is activated through address D2 of a relay module. The alarm is reset again by a push-button on address H1.

2.4.7. Common Siren



- Function: Common output of ISA-, Smoke-, Intruder- and Water alarm
- Application: Output of several alarms on one siren in addition to or in replacement of alarm system specific sirens
- Select with mouse ("Common Siren")

Description

The Common Siren offers the possibility of transmitting the alarms of all alarm systems on one channel. The alarm of the siren output behaves in the same way as the individual alarm sirens. If several alarms are on, they are indicated with the following priority:

1. Smoke alarm
2. Intruder alarm
3. Water alarm
4. ISA alarm

The operation of the common siren is independent of whether a siren was configured in the individual alarm system.

Note: The signal time entered in the Common siren is automatically adopted by the individual sirens. This also applies to reversed function.

If an alarm has been acknowledged or reset, the Mastergenerator also resets the signal of the common siren.

Parameters:

Parameter	Description
Common siren	
Channel function	Here you select one or several alarm systems whose alarm will also activate this siren.
Siren time	Here you enter the max. time for which this siren is to remain activated. The value can lie between 0 min and 60 min. (The Intruder alarm and ISA alarm allows infinite times, entered by the - (minus) key.

Application Example

Task: In a commercial building, different alarm systems (smoke, water, ISA and Intruder) are to activate the siren mounted outside.

Solution: The alarm systems described in the previous examples are used. The relay for the outdoor siren is configured for address I1. The siren time of each connected alarm is configured.

2.5. Roller blind control

2.5.1. Decentralized roller blind up-down function

	<ul style="list-style-type: none"> • Function: Up-Down control of roller blind motors • Application: Control of motors for roller blinds, sun blinds and roof windows through Dupline modules G 3430 4249. • Run time and Switch time individually adjustable • Tilted blinds for sun blinds and priority control for example for wind sensor.
---	--

Description

The decentralized roller blind up-down control makes it possible to run Dupline roller blind control modules for roller blind and sun blind motors. By organizing the up- and down-channels, the Mastergenerator ensures undisturbed operation by preventing both directions from being activated at the same time and ensuring that the delay time is observed.

The up-channel generally overrides the down-channel, ie if both are activated at the same time, the Mastergenerator will execute the up-command.

Address configuration

The roller blind control can only be configured for an uneven channel number. This means that the up-channel must have an uneven address number assigned to it and the down-channel must have an even address number assigned to it. This reflects the address coding of the roller blind modules. Here the up-channel must also have an uneven output assigned to it, while the down-channel must have an even output channel addressed to it.

Note: When, in spite of correct address configuration, the motor runs in the opposite direction, the corresponding connecting cables of the motor are reversed. In this case, correct connection must be ensured - the channels must under no circumstances be reversed.

Operation

The up- and down-buttons configured for the addresses of the roller blind control allow very simple operation:

- By pressing the direction key once, the motor runs to the end position or for the duration of the roll time.
- By pressing the same direction key once more, the motor stops.
- By pressing in the opposite direction, the motor stops shortly and runs in the opposite direction until it reaches end position or for the duration of the roll time.

When the option "Tilted blinds" is selected, the following options are available:

- If the direction key is pressed for less than three seconds, the motor stops when the key is no longer pressed.
- If the direction key is pressed for more than three seconds, the motor runs to the end position or for the duration of the run time. Here it is also possible to stop the motor by pressing the key once more or let it run in the opposite direction by pressing the other direction key.

The Tilted blinds function makes it possible to activate the sun blinds shortly, so that instead of causing up- or down-movement it changes the position of the tilting blinds.

Automating the roller blind control

Surely, many methods of automatic operation of roller blinds exist. Not only wind- and rain sensors, but also light sensors and clock timers increase comfort through automatic functions.

Such functions should - if not configured as priority address - usually be made by means of Logic setup, where primarily edge triggering is to be used which prevents continuous signals and allows permanent operator control. Further details can be found in the chapter on Logic Setup.

Connection of several motors

Simultaneous activation of several motors can be achieved by:

1. connecting all motors to separate outputs and
2. assigning the same address to all up-channels as well as all down-channels.

We strongly advise against connecting two or more motors in parallel to one output channel.

The flexible way of controlling several motors centrally or group-wise is to use the Roller blind master function. Further details are found in chapter 2.5.2.

Parameters

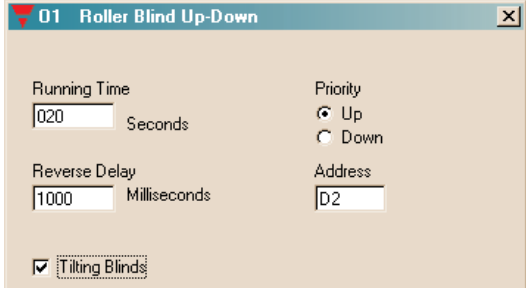
Parameter	Description
Roller blind control (Decentralized Up-Down)	
Roll time	<p>Insert the times (seconds) for which the motor is to run in each direction. The value must be within 0 and 255 s.</p> <p>The selected time interval should ensure that the roller blinds can reach the end positions in both directions where an end position contact must switch the motor off. Intermediate values allows shadow, for example. But it should be ensured that the roller blind is in one of the end positions before start.</p> <p>The entered roll time is overwritten by the roll time of the master.</p>
Reverse delay	<p>Enter the delay time (milliseconds) before the roller blind changes direction. The value should lie between 500 and 2000 ms.</p>
Tilting blinds	<p>This option allows adjustment of tilting blinds. The function stops within the first three seconds after the key is released.</p> <p>The tilting blinds option must be activated if you want to define for how long the roller blinds must run in the opposite direction after expiry of the roll time.</p>
Address	<p>By activation of the entered channel address, the roller blind runs in the selected direction for the entered roll time. As long as the indicated priority channel is set, input signals on the roller blind channels are ignored.</p> <p>Note: The priority channel also overrides the master control.</p>
Priority	<p>A channel or flag can be entered by which the up- or down-direction of the roller blinds is given priority</p>

Time characteristics

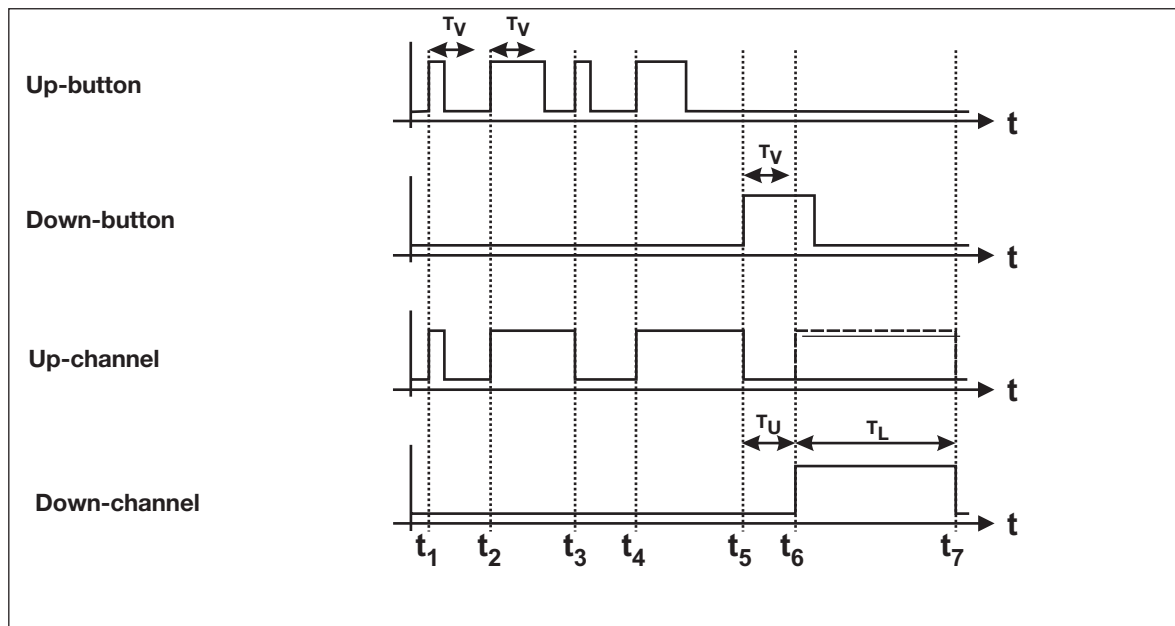

The above illustration is based on a roller blind application with adjustment of tilting blinds (Reverse Up time T_V of 3 s).

- t_1 : The button for the up-direction is activated. Since the impulse is shorter than the Reverse Up time T_V (3 s), the motor stops when the button is released.
- t_2 : The up-direction is activated again. Since the impulse this time is longer than the Reverse Up time T_V , the roller master control attempts to switch the channel on for the total roll time.
- t_3 : An additional actuation in the same direction stops the motor.
- t_4 : Now the button for the up-direction is activated again and the motor consequently started in the up-direction.
- t_5 : By activation of the button for the down-direction, the motor is stopped and the Reverse delay T_U starts.
- t_6 : After elapse of the Reverse delay T_U , the motor rolls in the down-direction.
- t_7 : After elapse of the roll time T_L , the motor is stopped. In order to reach the end of the roll time, the activation of the Down-button must last longer than the Reverse Up time T_V .

Application Example

Task: Control of several roller blinds as well as a roof window in a building. The system should include groupwise control for two different floors as well as master control of all roller blinds together. To protect the roller blinds, a wind sensor and a rain sensor are installed. The roller blinds are to roll down by rain and up by wind, and wind has priority. The roof window is to close by rain.

Solution: The roller blinds as well as the roof window are activated through Dupline roller blind control modules. For the group-wise and the master control, roller blind master controls are used. The address of the wind sensor is marked directly in the roller blind controls as priority address. The down-channel of the master control is activated through logic setup via the address of the rain sensor. Further details can be found in chapter 2.5.2.

Object	Function	Channel
In-/outputs		
Push-button inputs	Local activation	A1..B4 C1..D4
Push-button inputs	Group-wise Master	B5/6 D5/6 D7/8
Binary inputs for wind/rain sensors	Priority control	E1/E2
Relay outputs	Motors	A1..B4
Configuration		
Decentralized Roller Blind Up-Down	Roller blind/roof window control	A1.. B4 C1..D4
Roller Blind Master	Group-wise control ground floor	B5/6
Roller Blind Master	Group-wise control 1st floor	D5/6
Roller Blind Master	Master control	D7/8
Push-button function	Connection of	E1/E2

With the logic setup below, the rain sensor activates all roller blinds in the Down-direction through the master function. If the wind sensor channel is set, the command of the decentralized up-down control is not executed (priority control at each decentral roller blind object).

Output	Input 1	Function	Input 2
D8	/E2	AND	/E2

2.5.2. Roller blind master

	<ul style="list-style-type: none"> • Function: Group-wise or master control of decentralized roller blinds • Application: Group-wise or master control of motors for roller blinds, • Roll time with priority over individual roll times adjustable • Simultaneous or sequential roller blind start selectable • Reverse Up time for tilting blinds when end position reached. • Enter with mouse (“Roller blind master”)
---	---

Description

This object enables group-wise and master control of for example roller blinds, sun blinds and roof windows. The decentralized roller blind channels configured above (chapter 2.5.1.) are included in the Roller blind master by marking them in the channel matrix.

The roll time set for the Roller blind master applies to all individual controls and overrides their roll times. Entering a Reverse Up Time allows automatic adjustment of tilting blinds at the end of a cycle. After elapse of the set roll time, the Mastergenerator switches the motor in the opposite direction for the set Reverse Up time.

The Roller blind master offers two operation modes for starting the motors:

1. Simultaneous: All motors are started simultaneously.
2. Sequential: All motors - starting with the lowest address - are started at 1 sec. intervals. Thereby current peaks are avoided.

Address configuration

The Roller blind master can only be configured for an uneven address number. This means that the Up-channel must lie on an uneven (eg A1, B5 or P7) and the Down-channel must lie on an even address (eg A2, B6 or P8).

Operation

The Up- and Down-buttons configured for the addresses of the Roller blind master allows very simple operation:

- By pressing a direction key once, all selected motors roll until end position is reached or the roll time has elapsed.
- By pressing the same direction key once more, the set roll time starts again. Thus, it cannot be stopped.
- By pressing the other direction key, the motors stop shortly (decentrally set Reverse Up time) and run in the opposite direction until the end position is reached or the set roll time has elapsed.
- After elapse of the Down-time, the motors run in the Up-direction, provided that a Reverse Up time has been entered and the Tilting blinds function has been activated at the decentral roller blind control.
- During the master command, all motors can also be actuated through their individual decentral roller blind control channels. All functions of the decentral roller blind control are available (Stop, reversal of direction, adjustment of tilting blinds).

Automation of master command

Surely, many methods of automatic operation of roller blinds exist. Not only wind- and rain sensors, but also light sensors and clock timers increase comfort through automatic functions.

Such functions should - if not configured as priority address - usually be made by means of Logic setup, where primarily edge triggering is to be used which prevents continuous signals and allows permanent control by the operator. Further details can be found in the chapter describing the logic setup.

Hint: Please be aware that in the application of clock timers in particular, only one master command can be executed at a time. When several master commands are activated at the same time, the Mastergenerator only executes the command with the highest address number, eg H3/H4 before F7/F8.

Parameters

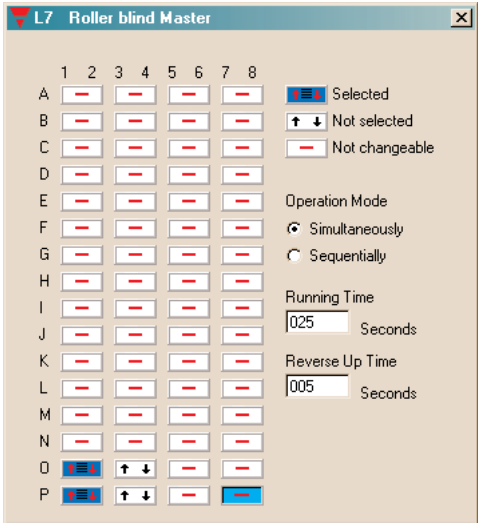
Parameter	Description
Roller blind master	
Operation mode	<p>The setting determines whether the roller blinds are started simultaneously or sequentially. With the setting “Sequentially”, the roller blinds start and stop successively at 1 second intervals. This time interval is also observed in connection with change of direction or tilting blind (Reverse Up time). This time interval does not affect the set roll time.</p>
Roll time	<p>The roll time determines for how long the roller blinds must run. This roll time overrides the roll time set in the Decentral up-down roller blind control.</p>
Reverse Up time	<p>The Reverse Up time determines the time in seconds for which the roller blinds must run in the opposite direction after expiry of the roll time. Applies to tilting blinds.</p> <p>Note: The Controller only executes the Reversing function in decentral roller blind controls in which the option adjustment of “Tilting blinds” has been activated.</p>

Time characteristics

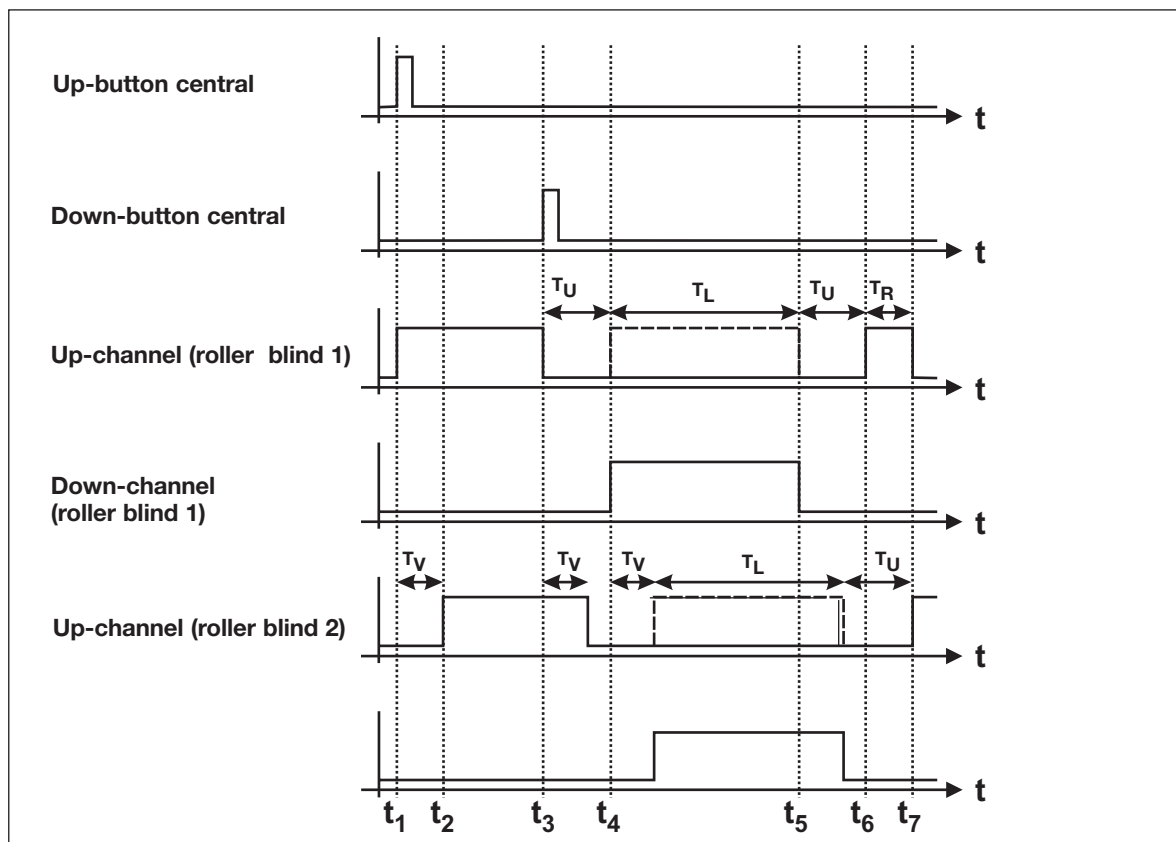

The above illustration is based on a roller blind master application with sequential operation mode and a Reverse Up time T_R .

- t_1 : The button for the up-direction is activated. The up-channel of the first motor is activated.
- t_2 : In the operation mode "Sequential", the Mastergenerator switches the up-channel of the second motor on after a time delay of 1 s.
- t_3 : Before elapse for the master roll time, the Down-button is actuated whereby the roller blind is forced in the opposite direction. The motors stop one by one, and the Reverse delay T_U set for the decentral roller blind object begins.
- t_4 : After elapse of the Reverse delay T_U , the first motor starts in the opposite direction, while the second motor is activated after a delay of 1 s.
- t_5 : After the end of the roll time T_L , the Reverse delay T_U is postponed due to the subsequent Reversing.
- t_6 : Based on the set Reverse Up time T_R , the roller blinds again run in the opposite direction in order to tilt the blinds.
- t_7 : After elapse of the Reverse Up time T_R , the motor of the first roller blind stops

Application example

A detailed example is described in connection with the decentralized up-down roller blind function.

2.6. Counter and Multiplexer

2.6.1. Multiplexer (transmission of counter values)



- Function: Control and transfer of counter values
- Application: Registration of energy and operating hours etc.
- Setup through the menu Edit, Counter and Mux Analog Setup

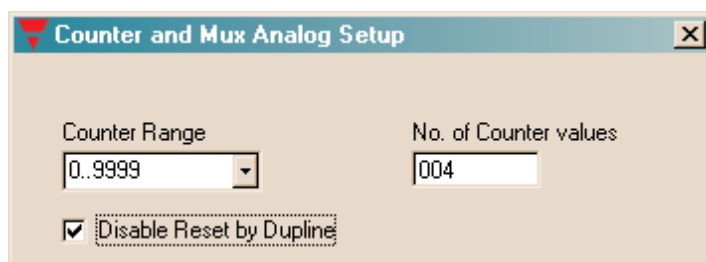

Description

The counter channels with the sum sign Σ are for transmission of counter values. This multiplex transmission of up to 128 counter values is dedicated to the use of the counter module G 4420 7401.

The range of values to be transmitted can be selected in the Basic setup through the option “Counter range”. Depending on the range of values, a corresponding number of address groups is reserved, whereby the Multiplex system is started.

Hint: The reserved addresses must **not** be used for other purposes, eg to output switch commands.

There are no further configuration possibilities in the Configuration software - addressing of the channels as well as transmission and saving of data is carried out automatically by the Mastergenerator.

Module configuration

Detection of the counter values requires correct setting of the counter module G 4420 7401. Apart from the setting the counter range, it is also necessary to assign an address to each module through rotary switch.

Data format

A description of the used data format can be found in the user manual of the counter module G 4420 7401.

Counter value output

Access to and output of the stored counter values is only done through the Modbus communication interface of the Mastergenerator. There are basically 3 possibilities of continued processing:

1. Representing the values in visualization software or operator panel (eg on a PC with the Dupline Web-Server).
2. Through communication programmes, eg the Dupline DDEServer - an open software interface to for example Microsoft® Office applications.
3. Individual reset of counter values.

Simultaneous operation with Multiplex Analog Value Transmisison

If transmission of counter and analog values is needed, care should be taken to avoid address overlap. The transmission channels of the analog modules must be set so that they do not overlap the channels of the counter value transmission. Read the following chapter 2.6.2. “Multiplexer (Transmission of analog values)”.

Parameters

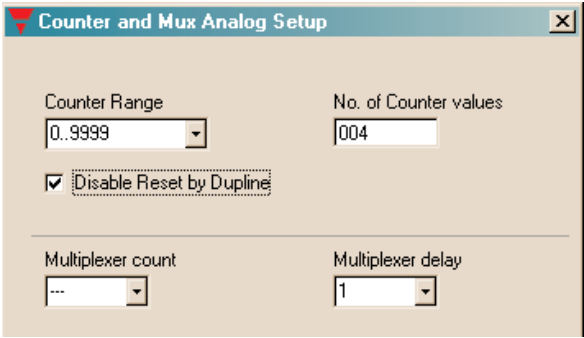
Parameter	Description												
(Detection of counter values)													
Counter range	<p>With this setting made under <Edit><Counter And Mux Analog Setup>, you select the range of counter values. Depending on the range, a corresponding number of channel groups, beginning by “B” are reserved:</p> <table border="1"> <thead> <tr> <th>Counter ranges</th> <th>Reserved groups</th> </tr> </thead> <tbody> <tr> <td>---</td> <td>None (counter operation switched off)</td> </tr> <tr> <td>0..99</td> <td>B..C</td> </tr> <tr> <td>0..9999</td> <td>B..D</td> </tr> <tr> <td>0..999999</td> <td>B..E</td> </tr> <tr> <td>0..99999999</td> <td>B..F</td> </tr> </tbody> </table>	Counter ranges	Reserved groups	---	None (counter operation switched off)	0..99	B..C	0..9999	B..D	0..999999	B..E	0..99999999	B..F
Counter ranges	Reserved groups												
---	None (counter operation switched off)												
0..99	B..C												
0..9999	B..D												
0..999999	B..E												
0..99999999	B..F												
No. of Counter values	<p>Defines how many Counter values are to be transmitted on the Dupline network. The default value is set to 128 counter values, however the real no of values should be entered, to generally increase the update-time.</p>												
Disable Reset by Dupline	<p>Select this option, to prevent accidental reset of the countermodules. Address B1, may be used for resetting ALL modules.</p>												

Application Example

Task: On a camping site, 64 current values are to be detected and used on a PC for the issue of invoices.

Solution: The counter modules G4420 7401 are built into the local power cabinets. Four Dupline energy Energy Kwh meters supply one G4420 7401 with the corresponding count-pulses. The Mastergenerator is configured to 8 digits, occupying addresses from B1 to F8.

Through the DDE server software, an application is built in a spread-sheet software, where the individual counters may be reset, when new guests arrive.

The voltage of the individual power outlet is turned on from the PC through a relay module. Free channels are used for this purpose.

The applied Mastergenerator can, of course, also perform additional automation functions.

Object	Function	Channel
In-/outputs		
Counter input	Detection of impulses from energy counter	B1..F8
Relay output	Switching power outlets	G1..N8
Configuration		
Counter range	Channels for counter values	B1..F8
Toggle switch function	Switches for power	G1..N8

2.6.2. Multiplexer (transmission of analog values)

	<ul style="list-style-type: none"> • Function: Object for detection of max. 112 analog values • Application: Fast transmission of multiplexed analog values through Dupline analog modules • Configuration under the option “Multiplexer channels” in the Basic setup
---	--

Description

The (original) multiplexing of analog values makes it possible to read and write Dupline multiplex analog values. As opposed to AnaLink transmission with analog sensors, two addresses are needed instead of one, which allows transmission of accurate analog values. The transmission speed is also higher. A full analog value needs one bus cycle, at best. AnaLink values need 256 cycles.

While for the transmission of counter values (see chapter 2.6.1.) only input modules are available, various Dupline output modules are available for multiplex analog values. The output modules have the output ranges 0..20 mA, 4..20 mA and 0..10 V.

In connection with the configuration of the multiplexer in the Basic setup (Options Multiplexer Count and Multiplexer delay), the Configuration software automatically reserves four channels (A1..A4) for addressing the modules. The addressing on these channels is performed automatically by the Mastergenerator. Data is transferred on two consecutive address groups (C/D, E/F, G/H, I/J, D/L, M/N and O/P). The channels can be set individually to the applied modules and can thus not be reserved by the Mastergenerator.

Also when the number is limited to 16 because only four channels have been reserved, 112 values can actually be processed. This is possible because up to 7 analog channels receive the same binary address, but subsequently transmit the values to different channel groups. (see above).

Note: The reserved addresses must **not** be used for other purposes, eg to output switch commands.

Module configuration

Transmission of analog values requires correct setting of the analog modules. Apart from the setting of the transmission channels, it is also necessary to assign a binary address to each module. Details can be found in the datasheets.

Data format

Within the two channel groups (in this case C and D), the value “1957” is generated continuously.

Time	Signal available		Value valid		Sign	Value in thousands				Value in hundreds				Value in tens				Single-digit value			
	C1	C2	C3	C4		C5	C6	C7	C8	D1	D2	D3	D4	D5	D6	D7	D8				
Factor				1	8	4	2	1	8	4	2	1	8	4	2	1					
Example:																					
Channel state:	1	1	0	1	1	0	0	1	0	1	0	1	0	1	1	1					
Value				1	9				5				7								

Signal available means that an input module continuously provides the value

Value valid indicates that the value is valid

An “0” stands for a positive value

An “1” stands for a negative value

Processing of analog values

As opposed to the counter values, it is not only possible to visualize the analog multiplex values through the Modbus communication interface, but also to change them. There are basically two possibilities of value processing:

1. Representing the values in visualization software or operator panel (eg on a PC with the Dupline Web Server).
2. Through communication programmes, eg the Dupline DDEServer - an open software interface to for example Microsoft® Office applications.

Simultaneous operation with transmission of multiplex analog values

If both multiplex modes are used, care should be taken to avoid address overlap. The transmission channels of the analog modules must be set so that they do not overlap the channels of the counter value transmission. Read the preceding chapter 2.6.1. "Multiplexer (Transmission of counter values)".

Working with test unit GTU8

GTU8 makes it easy to read out and simulate analog values of this format (operation mode Analog BCD). In the case of simulation, care should be taken that both the bit "Signal available" and the validity bit have been set (see above).

Parameters

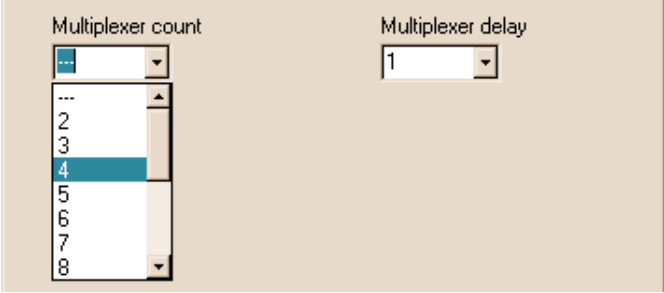
Parameter	Description
Multiplexer (Transmission of analog values)	
Multiplex channels	With this setting made under <Edit><Counter & Mux Analog Setup>, you select how many modules should be addressed. The number depends on the number of applied modules and their in-/output channels. From 0 to 16 addresses can be selected. The value 0 switches the multiplex operation out.
Multiplex delay	With this setting made under <Edit><Counter & Mux Analog Setup>, you select how fast the Mastergenerator may scan the multiplex addresses. This setting only has an effect when multiplex transmission has been activated (at least 1 multiplex channel selected). Since some of the Dupline Multiplex modules need a large part of their capacity for internal processing, their response time is reduced. This can be balanced by a longer delay. The Mastergenerator then waits for the corresponding number of cycles between the scans.

2.7 Reference to data from other Dupline networks

2.7.1. General

When several Mastergenerators are linked together in an RS485 network (see section 4.5), it is possible to include signal status from other Dupline networks in the intelligent functions. This can for instance be useful in a big building with several Dupline networks, when all the lights need to be switched off by activation of just one button, or when all the roller blinds need to roll up when the wind sensor connected to the Dupline network on the top floor measures a too high wind speed. In practice, there are three ways to make a reference to addresses in other Dupline networks, "External reference", "Read external Input" and "Status Indicator".

2.7.2. External reference

All the objects, except for the "Analog Sensor", have a button, located just below the description field, for selecting "Ext. Ref." When this button, is activated, a list pops up where it is possible to add or remove references to addresses in other Dupline networks. In the example below for address C1, external references are made to address D6 on the Dupline network with ID number 3, and to address B7 on the Dupline network with ID number 5.

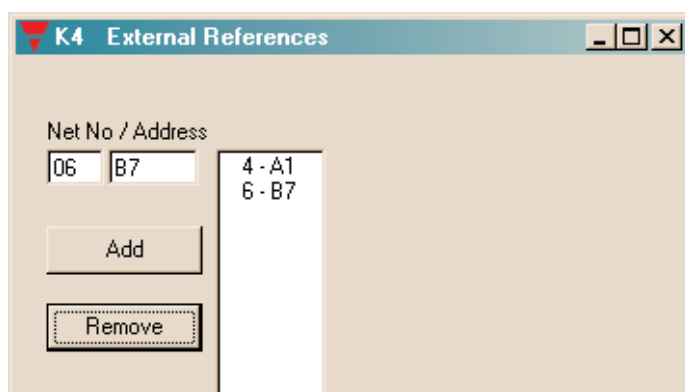

Parameter	Description
Net No / Channel	Whenever an external reference needs to be added or removed from the Ext. Ref. list, the Dupline network ID and the Dupline address needs to be entered here.

The External Reference list defines for the Mastergenerator, which addresses in the overall system shall act as inputs to the function assigned to the address the list belongs to (in the above example the list belongs to address C1). The input status of all the addresses on the list are OR'ed together with the input status of the address the list belongs to. In other words, if one of the addresses on the list or the local address has an active input, the Mastergenerator will regard the local address as having an active input when calculating the output status for the address.

Example 1:

If in the example above, address C1 is defined as "toggle switch" for light control, then the output C1 can now be toggled in 3 different ways:

1. The usual way by activating a pushbutton with address C1 in the "local" Dupline network
2. By activating the D6 pushbutton in the Dupline network with ID no 3
3. By activating the B7 pushbutton in the Dupline network with ID no 5.

Example 2:

In a 3-floor building, there is a Dupline network on each floor controlling the local lights. It is desired to have a pushbutton on the lower floor for turning OFF all the lights in the building. The Dupline network on the lower floor has ID no 1, the middle floor network has ID no 2, and the network on the top floor has been defined as RS485 Master (see sec. 4.5) and therefore has ID no 32.

The all-OFF function can be implemented the following way:

1. In each of the 3 Mastergenerators, a master function is defined on address E2 for turning OFF all lights on the local Dupline network.
2. The all-OFF pushbutton on the lower floor is coded E2 and will therefore turn OFF all lights on the lower floor when activated, as desired.
3. In the Mastergenerator on the middle floor, an External Reference has to be defined for the local Master Function on address E2 in order to enable the all-OFF pushbutton on the lower floor to trigger it. The reference is therefore made to address E2 on the Dupline network with ID no 1.
4. In the Mastergenerator on the top floor, an External Reference has to be defined for the local Master function on address E2 in order to enable the all-OFF pushbutton on the lower floor to trigger it. The reference is therefore made to address E2 on the Dupline network with ID no 1.
5. Activating the E2 pushbutton on the lower floor will now activate not only the local all-OFF Master Function on the lower floor, but also the all-OFF Master Functions on the middle and top floors, and thereby the desired function is achieved.

In the above example, the master function is assigned to address E2 in each Dupline network, but obviously, it is not necessary to use the same address. The addresses can be completely different, if desired.

2.7.3. Read external input

This function is only available for addresses used for Analink signals. The function makes it possible to use the Analink value transmitted on one Dupline network in all the other Dupline networks. If for example the signal from a wind speed sensor is transmitted on the top floor Dupline network, then the "Read External Input" function makes it possible for the Mastergenerators on the lower floors to use the wind speed value for control of the local roller blinds.

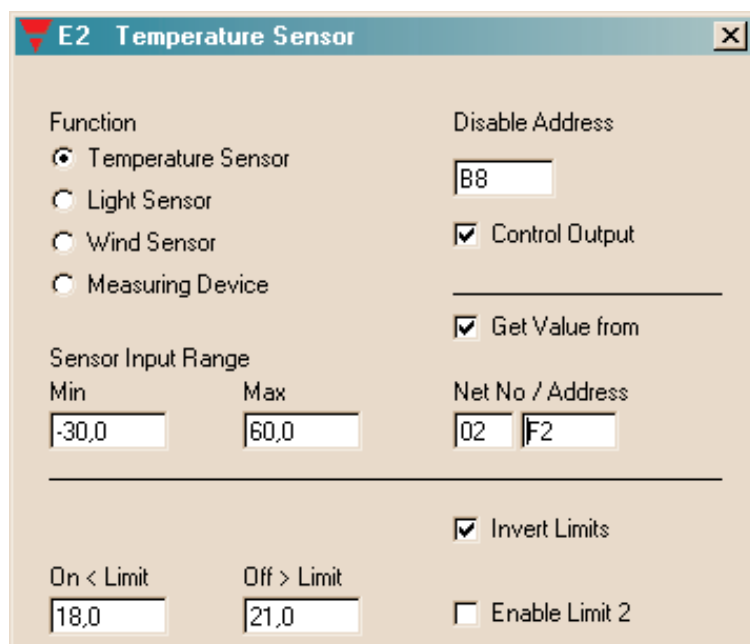

Parameter	Description
Read External Input	If selected, the Mastergenerator reads the Analink value from an external address.
Net No / Channel	Defines the Dupline Network ID no and address from where the Analink value shall be read.

When "Read External Input" is selected for an address configured as Analink, it becomes possible to enter the Dupline ID no. and address from which the Analink shall be read and used as input. In the example above, address D2 has been defined as Analink wind sensor, but because "Read External Input" is selected, the wind speed value does not come from the local Dupline network, but from the Dupline network with ID no 02 address F5. Other functions such as limit value monitoring with Control Output works exactly as if the Analink value came from a local sensor. So even though the Mastergenerators in the RS485 link are using the same input value from the Dupline network with ID 2 address F5, they can operate with different wind speed limits for forcing roller blinds up.

2.7.4. Status Indicator

Whereas "Ext. Ref." and "Read External Input" are referring to inputs from other Dupline networks, the "Status Indicator" refers to an external output. This means that it is possible to assign the output of a Dupline channel simply to be a copy of an address in another Dupline network. Only addresses defined as blank/indicator. Only addresses defined as blank/indicator channels can be used as Status Indicators (see sec. 2.2.1). The Status Indicator function can eg be used in connection with alarm systems. Each Dupline has it own alarm system, but by using the Status Indicator function it is possible in a Dupline network to read the status of an alarm signal in any other Dupline network.

3. Logic Setup

3.1. Introduction

The preceding chapters have illustrated the simplicity of configuring channels with the pre-defined objects. Praxis, however, is not always so simple. Many functions cannot be implemented by use of the predefined objects.

The Mastergenerator offers a splendid tool for solving these tasks: the logic functions, with which any relation can be established between the individual channels. The logic functions are described in the following chapter.

3.2. The dialog - logic functions

3.2.1. Setup

The processing of logic functions takes place in the Dialog "Logic Setup"

Dialog	Menu
Logic setup	Logic setup

Configuration window of the Logic funtions:

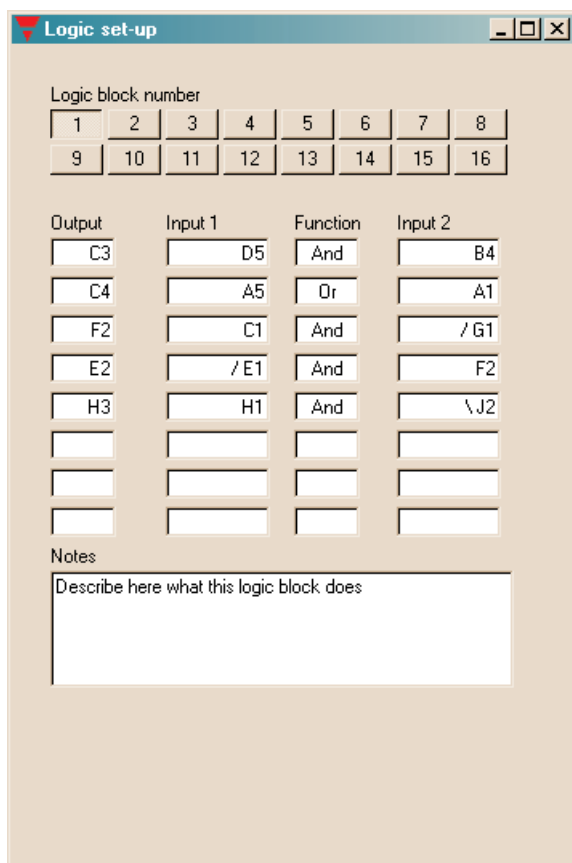

Each logic block always shows eight setups. The individual blocks are selected by pressing the corresponding block numbers. The selected block is marked by a small bar below the box.

Each setup consists of two inputs interconnected by an operand (eg AND). The result of the setup ("True or "False") is then assigned to the output.

Designation	Values	Description	Abb. 1)
Output	A1..P8 Q1..Z8	Channel or flag whose status is to be changed	A
Input 1	A1..P8 Q1..Z8 -,/,\ 	Channel or flag causing the first part of the conditions for the change in output status	E1
Function	AND, OR, XOR	The logic operand connection the two inputs	Fkt
Input 2	A1..P8 Q1..Z8 -,/,\ 	Channel or flag causing the second part of the conditions for the change in output status	E2

1) This abbreviation is used in the following to designate the various components.

3.3 Application

3.3.1. Setups and Functions

3.3.1.1. Creating Setups

Navigating

For jumping between the individual fields, press the Tab-key (forward) or the Alt- and Tab-keys (backwards)

Adding

All fields in a logic setup must be filled in, ie all 4 components must be available. Any number of setups can be selected, and gaps are allowed.

To add a function, place the cursor in any field in the row. Depending on the component, press a letter or number key.

Changing

Changes are made in the same way as additions: place the cursor in the field "Function" and overwrite the old value with the new value.

Deleting

The entire logic row can be deleted by placing the cursor in the field "Function" and press the Delete-key or the space bar.

3.3.1.2. Mode of operation

The in- and outputs can be channel addresses (A1 to P8) or flags (Q1 to Z8).

Depending on the inputs or logic setup (result of the function), the output is set in each bus cycle (max. all 134 ms). This means that the output assumes the value "0" when the setup is not fulfilled and the value "1" when the setup is fulfilled.

The three logic functions correspond to the mathematical functions AND, OR and XOR (exclusive of OR).

AND

The output is always "1", when both inputs are "1".

OR

The output is always "1", when one or both inputs are "1".

XOR

The output is "1", when only one of the two inputs is "1".

The following tables summarize the results of the logic setups:

AND		
E1	E2	A
0	0	0
1	0	0
0	1	0
1	1	1

OR		
E1	E2	A
0	0	0
1	0	1
0	1	1
1	1	1

XOR		
E1	E2	A
0	0	0
1	0	1
0	1	1
1	1	0

Example: If in the XOR-function, both input 1 (E1) and input 2 (E2) have the value "1", the output (A) will assume the value "0".

3.3.2. Inversion and Edge Triggering

A special feature of the logic functions is the possibility of inverting the output:

- When a - (minus) is added in front of the value, the input value and consequently the output are inverted, ie if the input had the value "0", it gets the value "1" and vice versa.
- Adding a / (slash) in front of the address leads to triggering on leading edge.
- Adding a \ (backslash) in front of the address leads to triggering on trailing edge.

This change in output does not affect the input channels or flags.

3.3.2.1. Inversion

Inversion can be applied to both channels and flags. The output can be of any type.

Example of a logic setup:

Output	Input 1	Function	Input 2
A1	E1	AND	-E2

Time characteristics

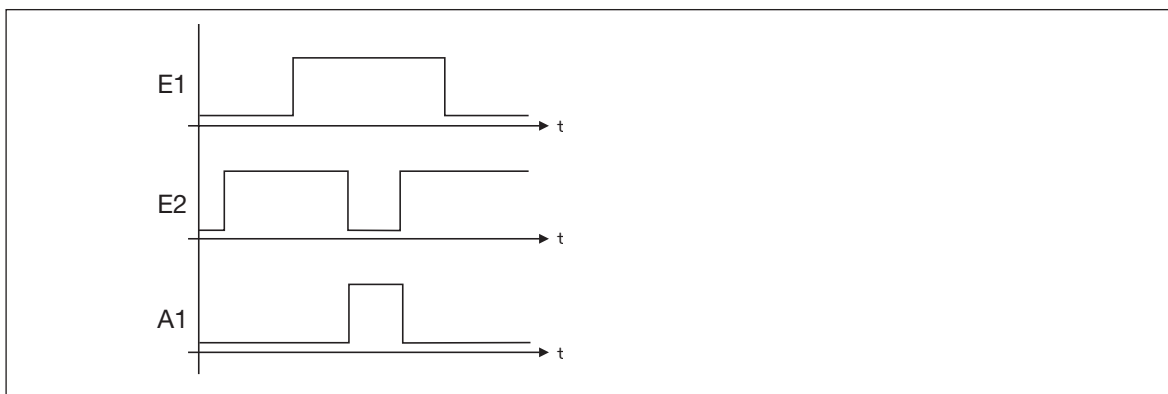

Output A is only active, when input E1 is active and input E2 is not active (range between the dotted lines). The internal processing in the Mastergenerator inverts the value of E2 before it is output (ie sees it as active).

3.3.2.2. Example of Edge Triggering

Edge triggering can only be used on channels A1 to P8. Since the process is dynamic and lasts only two bus cycles, it is necessary to select an output channel capable of processing impulses, eg channels with toggle switch function, timer function or master function.

A push-button function can also be generated with this setup, but it should be noted that in this case the output will only be active for one cycle.

Example of a logic setup:

Output	Input 1	Function	Input 2
A1	E1	AND	/E2

3.3.3. Using the on-board I/Os

The Mastergenerator facilitates 8 on-board I/Os. The 4 Inputs and 4 Outputs are assigned to specific flags, so they can be utilized via the logic functions.

I/O	Flag
Input 1	Q1
Input 2	Q2
Input 3	Q3
Input 4	Q4
Output 1	Q5
Output 2	Q6
Output 3	Q7
Output 4	Q8

Examples:

If it is desired that on-board Output number 1 shall follow the status of channel B5, the following line can be entered: Q5 = B5 and B5

If it is desired that on-board Input number 3 shall be transmitted on Dupline address C4, the following line can be entered: C4 = Q3 and Q3.

Please notice that **Firmware version 2,0** and onward implies changes in the flag addresses for the 8 on-board I/Os of the Mastergenerator.

In this case the user must manually alter his flag addresses from X, Y to Q:

	Inputs	Outputs
Firmware version < 2,0	Y1, Y2, Y3, Y4	X5, X6, X7, X8
Firmware version = > 2,0	Q1, Q2, Q3, Q4	Q5, Q6, Q7, Q8

3.3.4. Internal processing of the logic setups

The Mastergenerator processes the setups from the first expression in block 1 and onwards.

3.4. Notes and Documentation

For later documentation of the logic setups, it is useful to add comments in the field "Notes". When the logic setups are later printed out, the notes appear next to the individual rows so that each individual function is commented on.

3.4.1. Input definitions

The input definitions are used to document the coding of input modules (transmitters). The documentation created is a list of assigned names referring to the input-modules and how their respective I/Os are to be addressed.

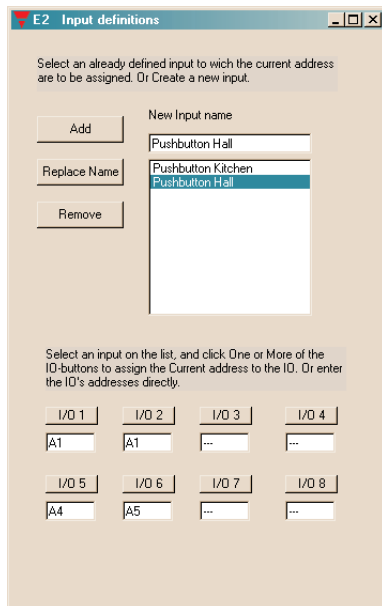

This information is stored in the Generator along with the configuration, and ensures that all documentation is available.

To create the list

- 1) Enter a name for the input name in the text entry field
- 2) Click on the Add button, to copy the name onto the list.
- 3) To assign I/O addresses to the input, mark the input on the list
- 4) Either click on the buttons I/O1 to I/O 8 to assign the current selected channel, as seen in the title-bar (A1), or enter the addresses directly in the I/O 1 ..I/O 8 fields.

To modify an item description in the list

- 1) Mark the item in the list, and the item name will appear in the text entry field
- 2) Modify the name, and click Replace Name button.

To remove an item in the list

Mark the item and click on the Remove button.

4. Communication Ports

4.1. General

The Mastergenerator is equipped with 3 serial communication ports, which can be used for configuration, communication with external devices and for networking of Mastergenerators. The two RS232 ports, COM1 and COM2, are accessible via two DB9 connectors in the front of the module, while the RS485 port is accessible through screw terminals. For pin-outs and technical details, please refer to the Mastergenerator datasheet. All three ports can be used simultaneously.

4.2. Protocol

The protocol used for all serial communication between the Mastergenerator and external devices is the Modbus protocol. The format of this protocol can be found on the homepage www.modbus.org. By using this protocol, the following functions can be performed:

- Read the digital output status of Dupline addresses (status of receivers)
- Read the digital input status of Dupline addresses (status of transmitters)
- Read the values from AnaLink transmitters (analog)
- Read the values from Counter Modules (type G44207401)
- Read the values from Multiplexed Analog Transmitters
- Read the pulse counts on Dupline addresses since last Reset command (note 1)
- Write data to activate digital Dupline addresses (writing a "1" to an address creates the same result as having an active transmitter on that address).
- Write data to force Dupline addresses ON (writing a "1" to an address will force the receiver outputs with this address ON, irrespective of the function assigned to that address)
- Write data to be output as multiplexed analog values
- Write data to change the set-points of Analink addresses (can eg be used to change the set-point of a temperature control function)
- Write data to change switching times on Dupline addresses configured for real-time control
- Issue commands for Reset and Freeze of pulse counts on specific Dupline addresses (Note 1)

Note 1: A pulse counter that increments on OFF-to-ON transitions is automatically assigned to each Dupline address. The counting is performed on BCD format in the range 0..9999 (if the count exceeds 9999 it will roll-over to 0). A "freeze" command must be issued prior to reading a pulse count from a Dupline address. The "frozen" value can then be read while the counting continues in the background. Issuing a reset command for an address resets the counter for that address.

A Modbus memory map defining which Modbus memory locations are used for the different types of data can be found in [Appendix C](#) of this manual.

The signal status of a given Dupline address can be read in any location related to that address in the Modbus memory map, but obviously, meaningful data is only achieved from the memory location reflecting the actual use of that address. If eg an AnaLink temperature sensor is connected to channel B5, it does not make sense to read the digital status of address B5, but it is possible.

In order to provide easy access to Dupline data from a PC, Carlo Gavazzi offer the Dupline data access package (DUPDATACC), consisting of a DDE-driver and an ActiveX-server. The DDE-driver offers the possibility to copy and paste Dupline data directly into EXCEL spreadsheets and other Windows applications, while the ActiveX driver makes it easy for Visual Basic, C++ and Delphi programmers to access Dupline data.

4.3. COM1

The RS232-port COM1 is typically used for download/upload of Mastergenerator configuration files, because it has a fixed baud-rate of 115 kBaud just like the configuration software. But it can also be used for communication with external devices such as PC's, PLC's and Touch Screens.

4.4. COM2

The RS232-port COM2 can be used for Dupline-Online operation. When Logged Dupline data is to be transmitted via Internet to the central Dupline-Online server, COM2 is used to send the Log Records to the external RS232-to-Ethernet converter ETHCONV1, which then takes care of the Internet transmission. COM2 has an adjustable baudrate in the range 2400 .. 115200 (note: for Dupline-Online operation the baudrate must be set to 9600). COM2 can also be used for communication with external devices such as PC's, PLC's and

Touch Screens, and for download/upload of Mastergenerator configuration files (requires a baud rate setting of 115200). There is also an option to use COM2 as the serial interface to Radio Modems (please refer to chapter 7 for more details on Radio Modem operation).

4.5. RS485

The RS485 port opens up the possibility to link up to 32 Mastergenerators together via an RS485 two-wire bus as shown below. One of the units, configured as RS485 master (#32), coordinates an automatic exchange of data between Mastergenerators, so that each unit is continuously updated with the status of every Dupline address in the entire system. Each Mastergenerator controls its own section with 128 addresses, but can be configured to be influenced by signals from other networks (see sec. 2.2). If for example the Dupline network on the top floor of a building has a wind speed sensor connected to it, then the Mastergenerators in all the other Dupline networks will be able to read and use the wind speed in the local roller blind control function. Other examples is the possibility to switch of all lights in the entire building by activating one pushbutton at the ground floor, and the option to collect all alarm signals in one Mastergenerator.

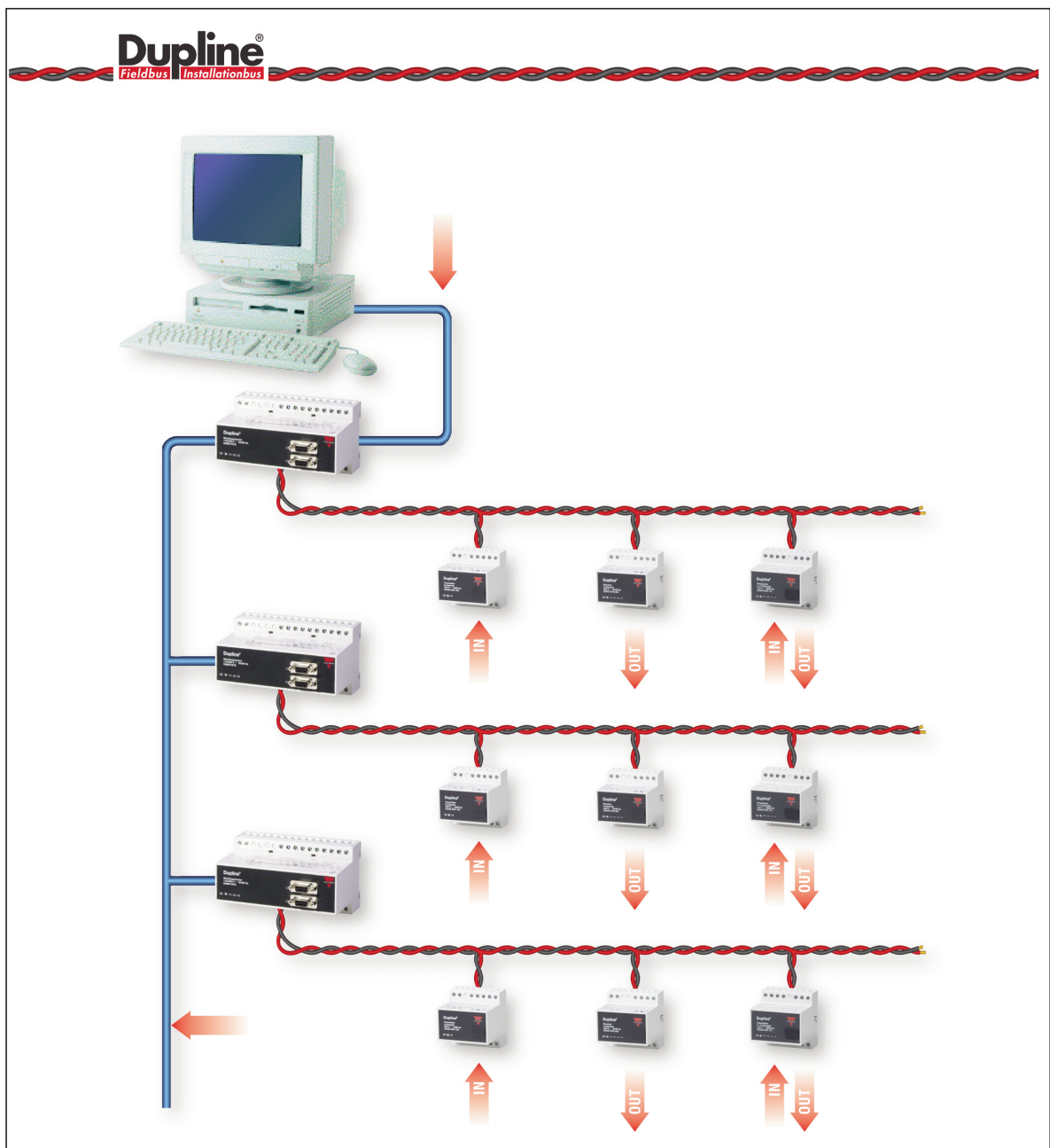

This system topology ensures a safe system operation, because in case of a short circuit or interruption of the RS485 network between Mastergenerators, the control functions on each Dupline network will continue to operate, but of course only based on the local signals. Also, if one of the Dupline networks is short circuited or interrupted, the other Dupline networks will continue to operate.

In these systems, it is common to have a PC with SCADA software for monitoring the entire system and for changing control parameters like temperature set-points and switching times. In large Dupline systems, this is achieved by connecting the COM-port of the PC to one of the RS232 ports of the Mastergenerator operating as RS485 master. This enables the PC to read and control data in all the Dupline networks, and to read or write a configuration file to any Mastergenerator using the Modbus protocol.

It is also possible to use a PLC or PC as master in the RS485 network. In this case there is no automatic data exchange between the Dupline networks, but the reaction time on the RS485 network is slightly faster.

For RS485 installation guidelines, please refer to [Appendix B](#) of this manual.

4.6. Setup of Communication Ports

Communication Setup

ID Number	No. of Slaves
01	01
<input type="checkbox"/> Set as RS485 Master	RS485 Baud Rate
	57600 Baud
	<input checked="" type="checkbox"/> Clear Slave data upon loss of communication
	Clear data after
	005 Seconds

COM2 Operation	COM2 Baud Rate
ModBus RTU	19200 Baud
ModBus RTU	
Radio Modem Central	
Radio Modem SubStation	
Automatic Data Logging	

Parameter	Description
ID Number	The ID number can be selected in the range 1..32, and must be used when accessing Dupline data via the Modbus protocol. When several Mastergenerators are networked via RS 485, each unit must have a unique ID number.
RS485 Baudrate	Defines the baudrate used for the RS485 communication. All units in the RS485 network must be configured for the same baudrate.
Set as RS485 Master	In the network solution described in sec. 4.5, one (and only one) of the Mastergenerators must be set to operate as RS485 master to control the automatic data exchange. If "Set as RS485 Master" is selected, then the module will automatically get ID number 32 assigned to it.
Clear slave data upon loss of communication	Defines how the Mastergenerator will operate if it loses the RS485 communication. If "Clear slave data upon loss of communication" is selected, then the Mastergenerator will disregard the data from other Dupline networks in its control function. If not selected, the Mastergenerator will use the last received valid data from the other Dupline networks.
No. of slaves	Defines how many slaves are present in the RS485 network. This only needs to be defined if the Mastergenerator is set as "RS485 Master". <i>Please note that the slaves must be assigned ID numbers from 1 and onwards.</i> If for example there are 4 Mastergenerators in the RS485 network operating as slaves, then they must be assigned ID numbers 1,2,3 and 4 respectively.
Clear Data after	This input is only relevant if "Clear slave data upon loss of communication" is selected. It defines how long time the Mastergenerator shall wait to receive valid data from other Dupline networks before it starts disregarding the last received valid data.
Com2 operation mode	Automatic Data Logging (see chapter 6), Modbus communication or Radio Modem operation (see chapter 7)
MG Com2 Baudrate	Defines the baudrate used for the Mastergenerator COM2

5. GSM Modem functions

5.1. SMS Setup

The G38001036 Mastergenerator has a built-in GSM Modem, which can be used in two different Operation Modes. In the mode "Send SMS to Dupline Online", the Mastergenerator sends the Log Records to a Central Server using the GSM network. In this operation mode, the Mastergenerator can also receive control commands from the Central Server via SMS messages. The alternative operation mode is to use the GSM Modem for monitoring and control of Dupline signals via SMS messages to/from mobile telephones (identical with the standard operation mode in G3800X036).

In order to make use of the GSM modem, the following is required:

- A SIM-card with the pin-code 9090 needs to be inserted into the slot in the front of G38001036. The pin-code can be changed, by inserting the SIM-card in a mobile phone and making use of the setting possibilities in the mobile phone. The SIM-card must be a 3V type.
- A GSM antenna needs to be connected to the FME connector on G38001036. If the unit is installed in a metal enclosure, the antenna must be installed outside the enclosure and connected to the Mastergenerator via a cable (an antenna of this type is available, with type number ANT1).

A LED in the front of G38001016 indicates the status of the GSM modem. By emitting different blink patterns, the LED indicates "connecting", "SIMcard missing", "No network found", "No response from modem", "SMS sent" and "SMS received". See appendix A for further information about the LED indications.

In order to set up the basic SMS functions, select "SMS Setup" in the Edit menu.

Parameters

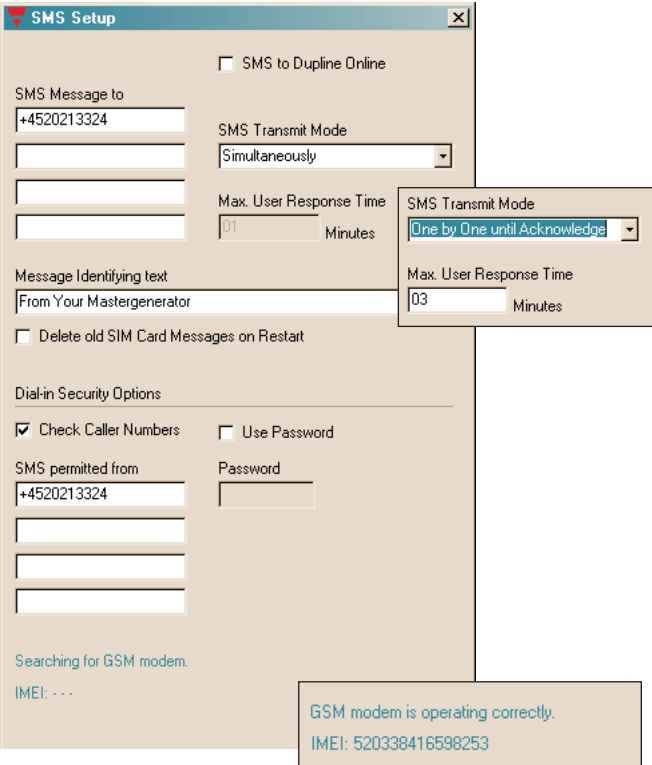
Parameter	Description
	 <p>The screenshot shows the 'SMS Setup' dialog box with the following visible settings:</p> <ul style="list-style-type: none"> <input type="checkbox"/> SMS to Dupline Online SMS Message to: +4520213324 SMS Transmit Mode: Simultaneously Max. User Response Time: 01 Minutes Message Identifying text: From Your Mastergenerator <input type="checkbox"/> Delete old SIM Card Messages on Restart Dial-in Security Options: <ul style="list-style-type: none"> <input checked="" type="checkbox"/> Check Caller Numbers <input type="checkbox"/> Use Password SMS permitted from: +4520213324 Password: [empty] Status: Searching for GSM modem. IMEI: --- Success message: GSM modem is operating correctly. IMEI: 520338416598253

Parameter	Description
SMS message to	Up to 4 telephone numbers to which the SMS messages shall be sent can be entered. In case "Send SMS to Dupline Online" is selected, only the telephone number of the Central Server needs to be entered. The country code must be included in the numbers (eg +4520213324). It can be selected if an event-based SMS message shall be sent out to all the telephone numbers on the list simultaneously, or if it shall be sent to the telephone numbers one by one, until an acknowledgement is received. Acknowledgement is performed by sending either a request or just an empty SMS message to the Mastergenerator.
SMS to Dupline Online	This Operation Mode must be selected if the GSM Modem shall be used to send log records to a Central Server (Dupline-Online). In this case, only a few parameters (like e.g. the phone number of the central server) need to be entered, and chapters 5.2 and 5.3 of this manual can be skipped.
Max. User Response time	Only valid when "one by one to acknowledge" is selected. Here, the maximum time the Mastergenerator shall wait for a response from a called number is entered. Otherwise the next number will be called. Acknowledge: Either a request, a command, or an empty SMS (password must be included, if user password is selected).
Message Identifying text	Optional SMS identifier text, that will be included in the SMS messages sent by the Mastergenerator.
Delete old SIM Card Messages on Restart	Check this box to erase "old" unread SMS messages on the SimCard, during System power-Up. This is to prevent out-dated messages from interfering.
Check Caller Numbers	Check this box to activate the Dial-In number protection. Any received SMS-message, contains the original phone-number. This number must exist in the Dial-In numbers list, before any command is accepted by the Mastergenerator, when this option is selected.
SMS permitted from	Enter the phone numbers, which are allowed to send control and read commands to the Mastergenerator. The country code must be included in the numbers (eg +4520213324).
Use Password	Check this box to activate the Password-protection. Any received SMS-message, will then be checked for the correct password, before any command is accepted by the Mastergenerator.
Password	Type in a password with 4 characters, to be used in case "Use Password" is selected.

Dial Out Phone-Numbers

Up to 4 telephone numbers to which the SMS messages shall be sent can be entered. In case "Send SMS to Dupline Online" is selected, only the telephone number of the Central Server needs to be entered. The country code must be included in the numbers (e.g. +4520213324).

It can be selected if an event-based SMS message shall be sent out to all the telephone numbers on the list simultaneously, or if it shall be sent to the telephone numbers one by one, until an acknowledgement is received. Acknowledgement is performed by sending either a request or just an empty SMS message to the Mastergenerator.

5.2. Event-based SMS messages

If the mode "SMS to Dupline Online" is not selected, the GSM modem is used for control and monitoring from mobile phones. There are 3 different ways to use the SMS messaging:

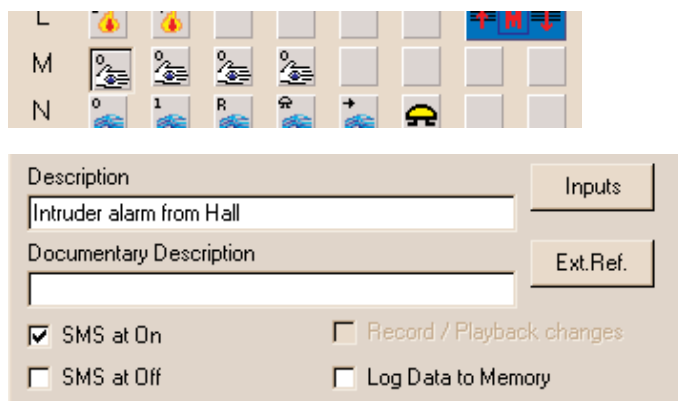

If the "SMS by ON" box is checked, the Mastergenerator will send an SMS with the time and date, the identifying text, the description text for the channel and the status, whenever E1 becomes active. The recipient of the SMS will see the following message in the display of the GSM phone:

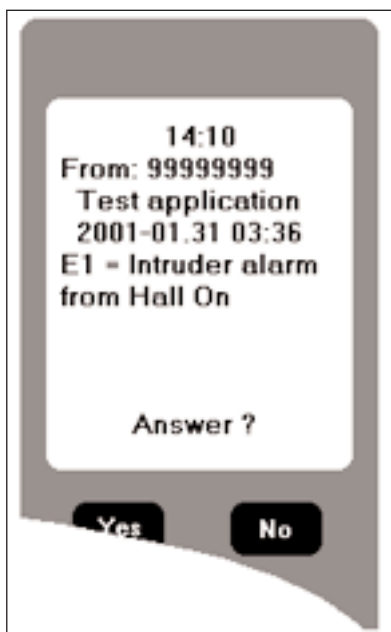

If more dial-out phone numbers have been defined, an acknowledgement can be sent to the Mastergenerator by sending an empty SMS message back. The Mastergenerator will then stop sending messages to the following phone numbers.

SMS messages for AnaLink channels contain the actual AnaLink value.

5.3. SMS Control commands and Requests for Dupline data

Commands for control or triggering of channel functions can be sent to the Mastergenerator via messages. Also, it is possible to send an SMS to the Mastergenerator with request for channel status. The Mastergenerator will then answer by sending back an SMS with the requested data. The format of the SMS commands and requests is shown in the example below:

With password option	
Controlling command	Example
Password, Channel, argument	1234,F4,on
	1234,F4,on
	1234,Alarm reset,on
Request Command	Example
Password, Channel,?	1234,F3,?
	1234,Siren,?

Without password option	
Controlling command	Example
Channel, argument	F4,on
	Alarm reset,on
Request Command	Example
Channel,?	F3,?
	Siren,?

NB: When using controlling commands on a channel, which is also configured to send a message when changing status, the message will also be sent to the GSM phone.
Not all channel types can be controlled.

As it can be seen, it is possible to use either the channel reference directly (eg F4) or to use the descriptive text defined for that channel.

The only channel types whose outputs are actually controlled directly ON or OFF by the SMS command are the Toggle and Realtime channels. For push-button, Timer, Master, Roller Blind, Alarm Reset and Acknowledge channels, an SMS ON-command will initiate a pulse on the channel and thereby be able to trigger a function (eg a Master function or logic function). In this way, it is avoided that non-resettable channel activations appear. An SMS OFF-command to these channels may not ensure that the channel output is turned off, since the output of the channel is also controlled by transmission on the channel. All other channel types cannot be controlled via SMS.

Note: The selected country language for on and off can be used as commands. However, we recommend the user to use the English terms "ON" and "OFF".

6. Data Logging Functions

6.1. General

The Dupline Mastergenerator can be configured to log Digital signals, Analink signals, Multiplexed analog signals and Counter values. The loggings can either be event or time based. Logged values are always stored in non-volatile memory to enable later retrieval. Simultaneously, at the actual time of logging, the values can be sent to the Central Dupline-Online Database via GSM modem or the Internet. The Dupline-Online WebServer then makes it possible for users with individual passwords to access own real-time and historical Dupline data via the Internet.

6.2. Dupline-Online

Dupline-Online is a new Internet based concept for central and de-central monitoring and control of remote facilities such as water works, power stations, apartment buildings, super markets, gas stations, car wash machines, elevators and unmanned railway stations. As the interface to the physical layer, the Dupline Fieldbus collects and controls all desired field data such as energy, water and gas consumption, alarms, lighting, pumps, movement detectors, temperature, humidity, pressure, fluid levels etc. The Dupline Mastergenerator can be programmed to log any combination of digital, analogue and counter signals based on events or time and send them to the central Dupline-Online Database via the built-in GSM Modem (optional) or via the Internet. Users can then access own real-time and historical data on their existing internet-connected IT-equipment by entering username and password on the homepage www.dupline-online.com. Dupline-Online services include alarm buffers with time and date tags on all events, trend curves for analogue signals, histograms with daily energy consumption, export of data to other systems, SMS alarms to mobile phones and buttons for switching signals at the remote site.

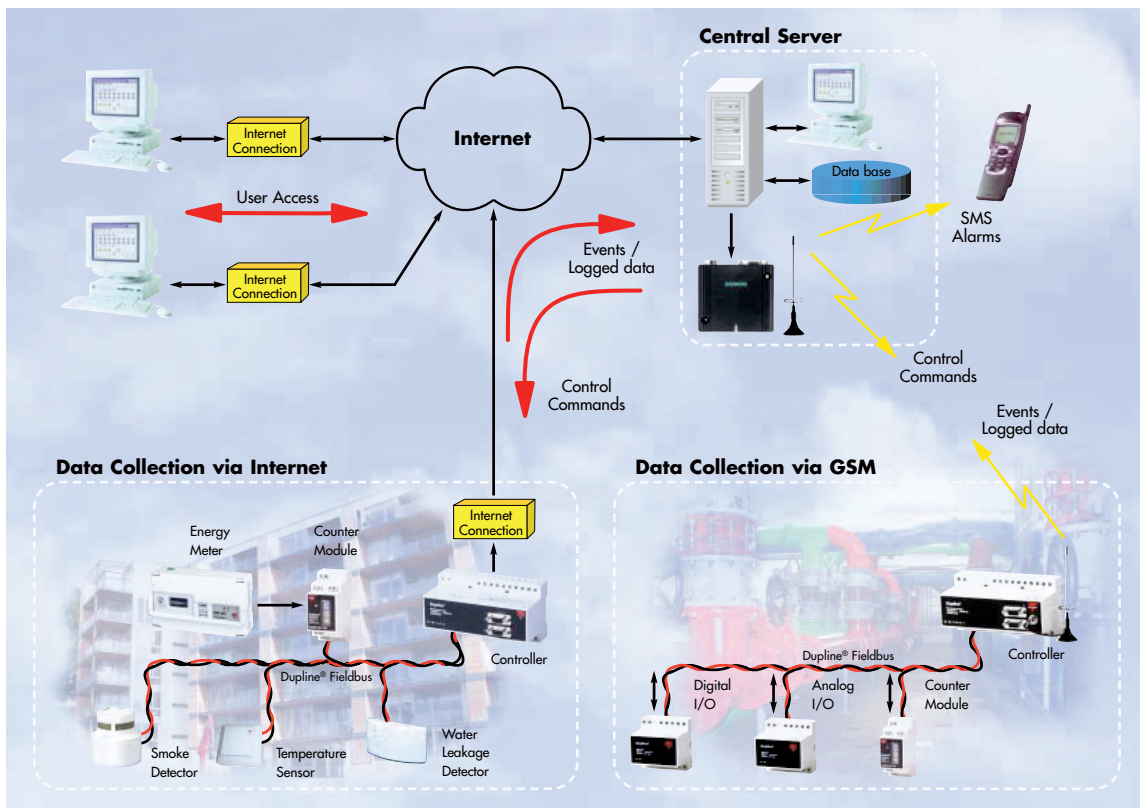

The following steps are required for setting up a Mastergenerator for Dupline-Online operation:

- Select the media for transmitting the Log Records to the Central Server (GSM Modem or the Internet)
- Select the desired Dupline addresses for event-based logging and enter text descriptions
- Select the desired Dupline addresses for time-based logging and enter text descriptions, scaling factors, engineering units and logging time intervals
- Download the configuration file to the Mastergenerator
- Generate a special Dupline-Online configuration file to be exported to the Central Server via the Internet

In the following sections of Chapter 6, it is described how to go through these steps (except for download of the configuration file to the Mastergenerator, which is described in sec. 1.2.1)

6.3. Dupline-Online Transmission Media

6.3.1. Using GSM Modem

The procedure for configuring the Mastergenerator for sending the Log Records to the Central Server via GSM Modem is described in Chapter 5 (GSM Modem Functions).

6.3.2. Using the Internet

In order to use the Internet for sending the Log Records to the Central Server, "COM2 Operation Mode" must be set to "Automatic Data Logging" (see sections 4.4 and 4.6). Also, "COM2 Baud Rate" must be set to 9600. This is the only configuration required in the "Communication Setup" menu in order to set up Dupline-Online operation. In terms of hardware, an external RS232-to-Ethernet converter (item number ETHCONV1) is required. The converter needs to be connected to COM2 of the Mastergenerator by means of the RS232 cable included in the ETHCONV1 package. The connection to the Ethernet is carried out by means of a standard Cat 5 Ethernet cable. In the majority of cases, this cabling is all that needs to be done to bring the converter into operation, because it is pre-configured to send the Log Records to www.Dupline-Online.com and to be installed on a network with a dhcp server, which automatically assigns an IP address to it. If a dhcp server is not available on the network, it is easy, however, to assign a specific IP address to the converter.

It is always the Mastergenerator that initiates the communication from inside the local network by opening a TCP/IP socket connection to the Central Server. Because of this, there is usually no need to change any setup in the firewall in the network or in the converter. This is only necessary in those cases, where the firewall is filtering connections made from inside of the network, and this is quite unusual, because then free Internet access is also inhibited.

6.4. Event-based logging

This is the standard (and only) logging method for Digital signals, but it can also be used for Analink signals. Whenever a Digital Dupline Address, which has been configured for logging, changes status, a Log Record is generated and saved in non-volatile memory. If configured to do so (see section 6.2 and 6.3), the Mastergenerator will also send the Log record via GSM or the Internet to the Central Dupline-Online WebServer, where it is saved in a database. The Log Record contains the Address, the new status of the signal (ON or OFF) and time/date/year of the event. Event-based logging of an Analink signal takes place whenever the value crosses the limits defined in the setup of the Analink address. The Log Record contains the Address, the Analink value and time/date/year of the event.

The selection of which signals shall be logged as events is performed under the setup menu for each individual channel.

Description	Inputs
Intruder alarm from hall	
Documentary Description	Ext.Ref.
<input checked="" type="checkbox"/> SMS at On	<input type="checkbox"/> Record / Playback changes
<input checked="" type="checkbox"/> SMS at Off	<input checked="" type="checkbox"/> Log Data to GSM

Menu Item:	Explanation:
Description	This text is used as description for the selected channel address when accessing the logged data via Dupline-Online. Other languages can be inserted in the 3-language menu.
Log Data to GSM	If selected for a digital channel, the Mastergenerator will send a log record to the Dupline-Online Webserver each time this Dupline channel changes status from OFF to ON or ON to OFF. If selected for an Analink channel, the Mastergenerator will send a Log Record each time the Analink value crosses one of the user-defined limits, and whenever the log interval time selected in the menu "Analink Log Set-up" (see section 6.5) has passed since last time-based log. <u>Note:</u> The menu Item text is dynamic, so if "automatic logging" has been selected for COM2 in the Communication setup-menu, the menu text will be "Log Data to COM2".

6.5. Time-based logging

6.5.1. Introduction

This method can be used for Analink signals, Multiplexed analog signals and Counter values. For each of these 3 signal categories, a logging time interval in the range from 5 minutes to 1 month can be defined. The signals within each category are then logged on a continuous basis according to the selected time interval. The Log Record contains the Address, all the logged values within this category and time/date/year of the Log Record.

6.5.2. Time-based logging of Analink channels

As described in sec 6.4, the selection of which Analink channels shall be included in time-based logging is done under the individual channel set-up by choosing the "Log Data to GSM" option. The Analink Log Time Interval must be defined in the menu "Analink Log set-up".

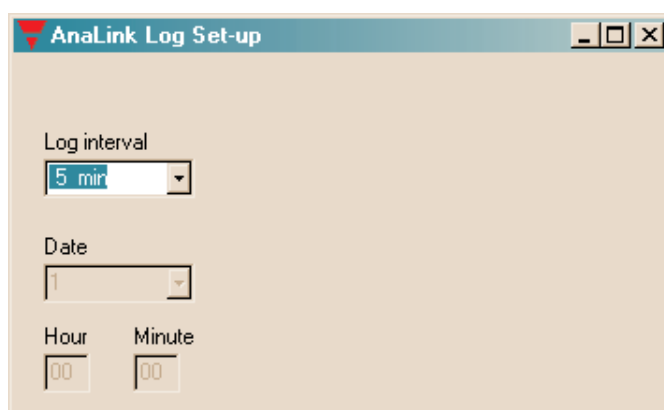

Menu Item:	Explanation:
Log interval	Defines the time interval between Analink Log Records.
Date	Only relevant when Analink signals are logged on a monthly basis. Defines the day of the month on which the Log Record shall be made.
Hour and Minute:	Only relevant when Analink signals are logged on daily basis. Defines the time of the day on which the Log Record shall be made.

6.5.3. Time-based logging of Counters

The set-up for the logging of Counter values is performed in the menu “Mux Counters Log Set-up”. A table showing the counter addresses available (as defined in the menu “Counter and Mux Analog Setup”) is used for selecting the Counter addresses to be logged, and for metering text descriptions, scaling for these counters and engineering units. Also, the Log Time Interval for Counters is defined in this menu.

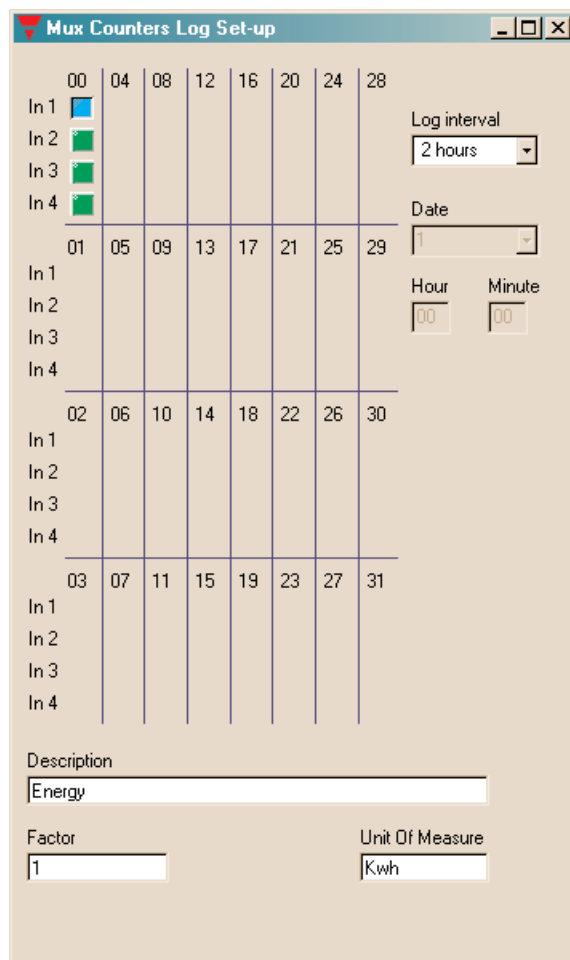

A Counter address is selected for logging by double-clicking on it with the mouse. The color of the associated field will then change to Cyan, and this indicates that the parameters entered under "Description", "Factor" and "Unit of measure" will now be assigned to this Counter address. The color of the field turns green when another menu or Counter address is selected, to indicate that the Counter address has now been configured for logging. To change a parameter for a Counter address, click on the associated green field and it will change color to cyan to indicate that the parameters shown belongs to this Counter address and that it is ready for changes.

To disable logging for a Counter, double-click on the associated green field.

Menu Item:	Explanation:
Description	This text is used as description for the selected Counter address when accessing the logged data via Dupline-Online.
Factor	Defines the ratio of pulses per unit of measure. If eg an Energy-meter with 640 pulses/kWh is used, then the figure 640 must be entered to get the correct kWh reading from the Dupline-Online database.

Menu Item:	Explanation:
Unit of measure	Defines the unit of measure for the Counter. If eg an Energy-meter with 640 pulses/kWh is used, then the "kWh" must be entered to get the correct reading from the Dupline-online data base.
Log interval	Defines the time interval between Counter log Records.
Date	Only relevant when a Counter is logged on a monthly basis. Defines the day of the month the Log Record shall be made.
Hour and Minute	Only relevant when an Analink signal is logged on a daily basis. Defines the time of the day the Log Record shall be made.

6.5.4. Time-based logging of Multiplexed Analog data

The set-up for the logging of Multiplexed Analog data is performed in the menu "Mux Analog Log Set-up". A table showing the Mux Analog addresses available (as defined in the menu "Counter and Mux Analog Setup") is used for selecting the Mux Analog addresses to be logged, and for entering text descriptions, scaling for these analog signals and engineering units. Also, the Log Time Interval for Mux Analog signals is defined in this menu.

A Mux Analog address is selected for logging by double-clicking on it with the mouse. The color of the associated field will then change to Cyan, and this indicates that the parameters entered under "Description", "Range lo", "Range Hi" and "Unit of measure" will now be assigned to this Mux Analog address. The color of the field turns green when another menu or Mux Analog address is selected, to indicate that the Mux Analog address has now been configured for logging. To change a parameter for a Mux Analog address, click on the associated green field and it will change color to cyan to indicate that the parameters shown belongs to this Mux Analog address and that it is ready for changes.

To disable logging for a Mux Analog address, double-click on the associated green field.

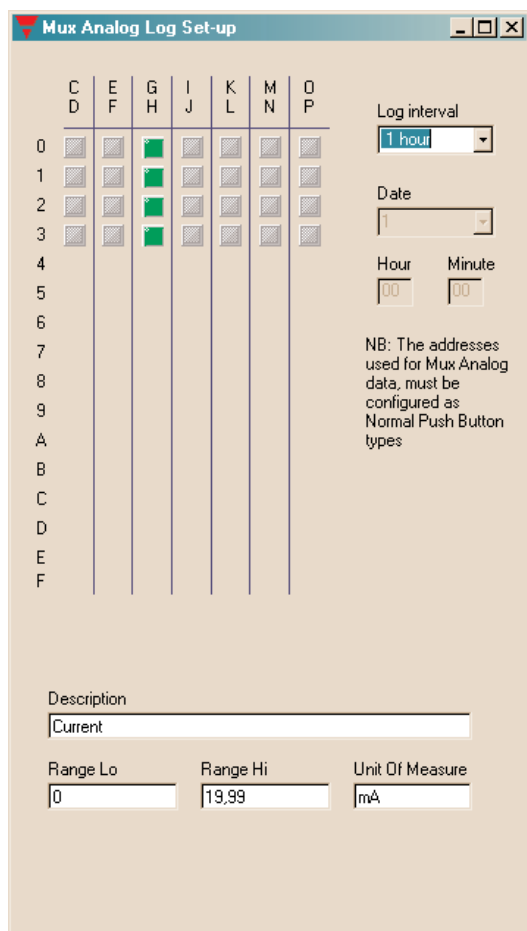

Menu Item:	Explanation:
Description	This text is used as description for the selected Mux Analog address when accessing the logged data via Dupline-Online.
Range Lo	Defines the lowest value of the analog input signal. Used for scaling of the Mux Analog value. If eg the analog signal comes from a level meter with the range 0-500 cm, then the "Range Lo" value is 0.
Range Hi	Defines the highest value of the analog input signal. Used for scaling of the Mux Analog value. If eg the analog signal comes from a level meter with the range 0-500 cm, then the "Range Hi" value is 500.
Unit of measure	Defines the unit of measure for the Mux Analog.
Log interval	Defines the time interval between Mux Analog Log Records.
Date	Only relevant when a Mux Analog is logged on a monthly basis. Defines the day of the month the Log Record shall be made.
Hour and Minute	Only relevant when an Analink signal is logged on a daily basis. Defines the time of the day the Log Record shall be made.

6.6. Export of the Configuration to the Dupline-Online Webserver

The configured logging functions with addresses, descriptions, scaling, units of measure etc. and the unique ID code of the Mastergenerator need to be uploaded to the Dupline-Online Webserver in order to ensure accept of Log Records received from this ID-code and correct handling of data. Therefore, after the configuration of the Mastergenerator has been finalized, "Export Configuration" needs to be activated in the File menu in order to create this file.

Registration of the Mastergenerator for Dupline-Online operation is performed by following the instructions on the homepage www.dupline-online.com. The registration procedure is very simple, because the "export configuration" file will automatically be requested, and this file contains all the information needed by the Dupline-Online Webserver. After registration the system is ready to operate.

6.7. Dupline-Online Data Security

Several means of ensuring data security have been implemented in the Dupline-Online system in order to provide a reliable and safe collection and protection of logged data:

- If Log Records are transmitted via the Internet, the Mastergenerator will continuously check if acknowledge telegrams for the individual Log Records are received from the Dupline-Online Webserver. If not, the relevant Log Records will be re-transmitted. The re-transmission buffer has capacity to hold up to 256 unacknowledged Log Records
- Log Records transmitted via the Internet are encrypted to inhibit hackers from inserting false Log Records/Control commands
- If Log Records are transmitted via GSM, the Mastergenerator will wait for an acknowledge message from the GSM network provider. If not, the relevant Log Records will be re-transmitted until an acknowledge message is received
- When GSM is used, it is checked that the sending telephone number for a Log Record or Control Command is valid
- Data Access via the Dupline-Online Webserver is protected by user names and passwords
- A back-up for the Dupline-Online Database is generated on a daily basis
- The Dupline-Online Webserver is protected by a comprehensive firewall

7. Radio Modem Functions

7.1. General

The Mastergenerator has a built-in driver for control of an external Radio Modem, which can be used to create wireless links where no cable is available in parts of an installation. One Mastergenerator must be defined as the central Mastergenerator and up to 32 Mastergenerators can be defined as remote Mastergenerators. The central Mastergenerator is continuously polling and updating the Dupline data from all remote Mastergenerators via the radio modem network, and in this way it makes the entire system operate as one big Dupline network. Apart from increased reaction time (depending on the number of remote Mastergenerators), the system will operate as if it was one Mastergenerator connected to all the I/O-modules with cable. The Mastergenerator supports the Radio Modem type 2ASxE and all 3AS types from the Finnish manufacturer SATEL (www.satel.fi). These are not supplied by Carlo Gavazzi, but are available with local support worldwide. Find below an application diagram for the Radio Modem option. Note: Analink modules cannot be used with Radio Modems.

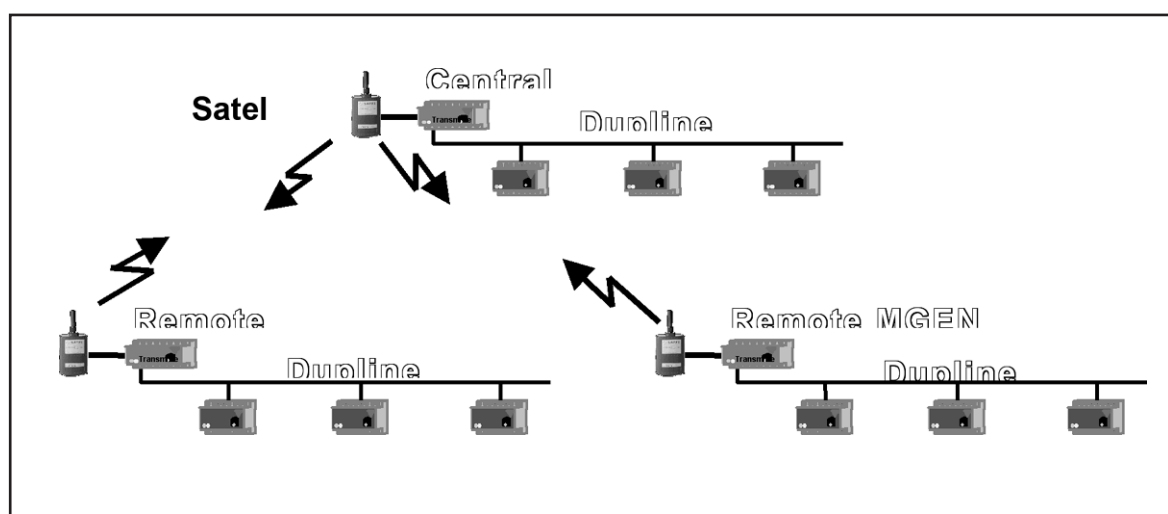

The Radio Modem must be connected to the COM2 of the Mastergenerator. For serial cable pin connections, please refer to the Mastergenerator datasheet. The baud rate selected for COM2 must correspond to the baudrate used by the radio modems and the other Mastergenerators in the network.

The central Mastergenerator must be defined for "Radio Modem central" function for COM2, while the remote Mastergenerators must be defined as "Radio modem substation". The central Mastergenerator can be configured for the usual intelligent functions, and it can also be connected via COM1 or the RS485 port to a PLC or PC. The remote Mastergenerators, however, cannot be configured for any intelligent function¹⁾. They will simply operate as Radio Modem interfaces. The system can handle all types of digital, analog (incl. multiplexed) and counter values, except for Analink values. The configuration of the Radio Modem function is performed in the menu "Edit" under "Communication setup".

1) For the remote Mastergenerators, the logic functions are available to enable access to the Mastergenerators' digital inputs and outputs.

7.2. Setup of Radio Modem Central

Parameter: Radio Modem Central	
Parameter	Description
Modem turn-around time	Defines the time delay the Mastergenerator uses when changing between receiving and transmitting. This can be used to adapt to individual radio modem types, which may have different requirements for this parameter. The default value of 100 ms will work in most cases.
Substation max. response time	Defines the time the central Mastergenerator will wait for an answer from a substation. If the Mastergenerator does not receive an answer within this time it continues to the next substation. The default time is 1 s, which is fine for most applications, but longer time may be needed if repeater stations are used on the radio modems.
No. of substations	Defines the number of substations connected via radio modem to the central Mastergenerator. Important Note: The Mastergenerators configured as "Radio modem substation" must be given the ID numbers from 1 and onwards. Example: When "No of substations" are set to 3, then the 3 Mastergenerators configured as "radio modem substation" must be given the ID numbers 1, 2 and 3 respectively.
Select groups for exchange of Mux analog	If multiplexed analog I/O's are used in the radio modem system, then it is necessary to define which "channel group pairs" are used for this purpose. This is simply done by selecting the relevant check boxes. It is only possible upon prior setup of Multiplex-count under the menu Counters and Mux Analog Setup.

7.3. Setup of Radio Modem Substation

Parameter: Radio Modem Substation

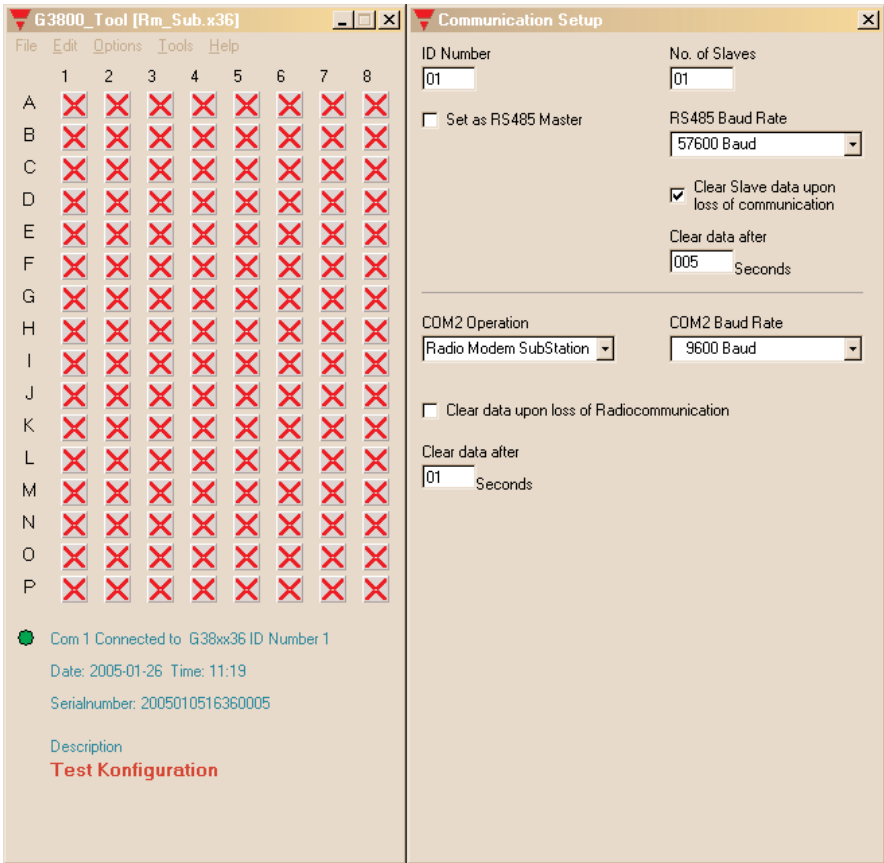

Parameter	Description
Clear data upon loss of radio communication	Per default, the substations maintain the last received Dupline output data no matter how long time has passed since the last telegram was received from the central Mastergenerator. If "Clear data upon loss of radio communication" is checked, then the output data will be cleared when the time-out defined in "Time to Data-clear" has run out.
Clear data after	Defines the time-out when "Clear data upon loss of radio modem communication" is selected.

Appendix A

Mastergenerator G3800 x0xx LED indication

Blink pattern	Supply LED	Dupline LED	RS 232 Com1/Com2	RS 485	GSM
Off	No supply	No carrier	OK	OK	OK or No Modem installed
1 blink 3 pauses	na				Connecting
2 blink 2 pauses	na				SimCard missing
3 blink 5 pauses	na				No Network found
4 blink 4 pauses	na		Data Error Download		
5 blink 3 pauses	na		Programming failed		No response from modem
Continuous blink	na	Shortcircuit Reset required	Programming		
1 blink	na			Netw.Comm	Sent SMS
2 blink	na				Received SMS
ON	OK	OK	Up-/Down-Loading		
Flashing					When modem installed and detected

na = Not applicable
Blanks = Unused

Modbus-RTU interface

Modbus-RTU is implemented with the function of a slave. The following Modbus functions are supported: 01, 02, 03, 05, 06 and 16. All 128 Dupline ® Digital, Analink, Counter, and BCD channels are placed as follows:

Modbus-RTU Functions implemented in the Master Generator

Read Functions

Function Code 01: Read Output Table Bit (Data to Receivers)

Register Address		Register 8 bit			
Dec	Hex				
1280	500	A1	00=OFF		Bit
1281	501	A2	01=ON		Bit
					Bit
1407	57F	P8			Bit

Reads information previously written by a Modbus command for transmission on Dupline
Reading of only 1 register at a time is allowed.
Value : 0 or 1

Function Code 02: Read Input Table Bit (Data from transmitters)

Register Address		Register 8 bit			
Dec	Hex				
1536	600	A1	00=OFF		Bit
1537	601	A2	01=ON		Bit
					Bit
1663	67F	P8			Bit

Reads Dupline Output-Status.
Reading of only 1 register at a time is allowed.
Value : 0 or 1

Function Code 03: Read Multiple Registers

Register Address		Register 16 bit			
Dec	Hex	Hi	Lo		
0	0	B8..B1	A8..A1		Digital
1	1	D	C		Digital
.
6	6	N	M		Digital
7	7	P	O		Digital

Reads Dupline Output status.
Reading of 1 to 8 registers possible.

If an attempt is made to read from a start-address and the number of registers exceeds the allowed register range, no answer will be made, as this is interpreted as an illegal function

Register Address		Register 16 bit			
Dec	Hex	Hi	Lo		
16	10	B8..B1	A8..A1		Digital
17	11	D	C		Digital
.
26	16	N	M		Digital
27	17	P	O		Digital

Reads Dupline Input status .
Reading of 1 to 8 registers possible.

If an attempt is made to read from a start-address and the number of registers exceeds the allowed register range, no answer will be made, as this is interpreted as an illegal function

256	100	A1	0	0..255		Analink
257	101	A2	0	0..255		Analink
258	102	A3	0	0..255		Analink
.	.	.	0	0..255		Analink
382	17E	P7	0	0..255		Analink
383	17F	P8	0	0..255		Analink

AnaLink values are readable. Irrespective of the configuration of the channels. If a value is read as FFFFh, the Sensor is not present.
Reading of 1 to 32 registers possible

512	200	0	0..99	0..99	0..99	0..99	Counter
514	202	1	0..99	0..99	0..99	0..99	Counter
516	204	2	0..99	0..99	0..99	0..99	Counter
			0..99	0..99	0..99	0..99	Counter
764	2FC	126	0..99	0..99	0..99	0..99	Counter
766	2FE	127	0..99	0..99	0..99	0..99	Counter

Counter value only valid if Counters are selected.
Value read in BCD
Reading of 1 to 32 registers allowed.

Dec	Hex	Mux	Hi	Lo	Value	
784	310	0	HI	LO	CD-0	Input Table
785	311	1	HI	LO	CD-1	Input Table
786	312	2	HI	LO	CD-2	Input Table
787	313	3	HI	LO	CD-3	Input Table
-	-	-	-	-	-	Input Table
799	31F	F	HI	LO	CD-F	Input Table
800	320	0	HI	LO	EF-0	Input Table
815	32F	F	HI	LO	EF-F	Input Table
816	320	0	HI	LO	GH-0	Input Table
831	33F	F	HI	LO	GH-F	Input Table
832	340	0	HI	LO	IJ-0	Input Table
847	34F	F	HI	LO	IJ-F	Input Table
848	350	0	HI	LO	KL-0	Input Table
863	35F	F	HI	LO	KL-F	Input Table
864	360	0	HI	LO	MN-0	Input Table
879	36F	F	HI	LO	MN-F	Input Table
880	370	0	HI	LO	OP-0	Input Table
895	37F	F	HI	LO	OP-15	Input Table

Multiplexed analog Read Input Table

Registers 0300H to 037FH BCD-VALUES
Registers 0400H to 047FH BINARY-VALUES

Multiplexed analog values only valid if Multiplexer is selected
 Reading of 1 to 32 registers possible

Dupline group AB holds the actual Mux-address on the 4 most significant bits.
 The remaining bits holds the digital transmit information from channel A5..B8

Dec	Hex		B8-B1	A8-A1		Digital
4096	1000		D	C		Digital
4097	1001		D	C		Digital
-	-		-	-		Digital
4103	1007		P	O		Digital

Reads information previously written by a Modbus command for transmission on Dupline
 Reading of 1 to 8 registers possible.

If an attempt is made to read from a start-address and the number of registers exceeds the allowed register range, no answer will be made, as this is interpreted as an illegal function

Dec	Hex		B8-B1	A8-A1		Digital
4112	1010		D	C		Digital
4113	1011		D	C		Digital
-	-		-	-		Digital
4119	1007		P	O		Digital

Reads information previously written by a Modbus command for forced output on Dupline.
 Reading of 1 to 8 registers possible.

If an attempt is made to read from a start-address and the number of registers exceeds the allowed register range, no answer will be made, as this is interpreted as an illegal function

Dec	Hex	Mux	Hi	Lo	Value	
4880	1310	0	HI	LO	CD-0	Input Table
4881	1311	1	HI	LO	CD-1	Input Table
4882	1312	2	HI	LO	CD-2	Input Table
4883	1313	3	HI	LO	CD-3	Input Table
-	-	-	-	-	-	Input Table
4895	131F	F	HI	LO	CD-F	Input Table
4896	1320	0	HI	LO	EF-0	Input Table
4911	132F	F	HI	LO	EF-F	Input Table
4912	1330	0	HI	LO	GH-0	Input Table
4929	133F	F	HI	LO	GH-F	Input Table
4930	1340	0	HI	LO	IJ-0	Input Table
4943	134F	F	HI	LO	IJ-F	Input Table
4944	1350	0	HI	LO	KL-0	Input Table
4959	135F	F	HI	LO	KL-F	Input Table
4960	1360	0	HI	LO	MN-0	Input Table
4975	136F	F	HI	LO	MN-F	Input Table
4976	1370	0	HI	LO	OP-0	Input Table
4990	137F	F	HI	LO	OP-15	Input Table

Multiplexed Analog Read Output Table

Registers 1300H to 137FH BCD-VALUES
Registers 1400H to 147FH BINARY-VALUES

Multiplexed analog values only valid if Multiplexer is selected
 Reading of 1 to 32 registers possible

In the Binary Data-area, the transmitted data are checked against valid BCD coding and also the control-bits from the Analog transmitter.
 Reading an "FFFF" indicates an invalid value or a non-existing analog transmitter.
 Eg. Reading BCD data on Group C, then the channels C1 and C2 has to be active, before a binary value are read. This is done automatically by the analog transmitters.

Dec	Hex		Hi	Lo	Substations	Status
8192	2000		HI	LO	Substations 1..16	Status
8193	2001		HI	LO	Substations 17..32	Status

Active Devices found in Radio-Modem Network.
 (When configured as Radio-modem Central)
 32 bits indicating the presence of a Radio-Modem substation.
 Register 2000h, MSB = Substation no 00 (central=0). LSB = Substation no 15
 Register 2001h, MSB = Substation no 16 LSB = Substation no31.
 2 Registers.

Dec	Hex		Hi	Lo	Substations	Status
8194	2002		HI	LO	Substations 1.. 16	Status
8195	2003		HI	LO	Substations 17..32	Status

Active Devices found in the RS485 Network
 32 bits indicating the presence of slaves in the Network
 Register 2002h, MSB = Slave no 00 (central=0). LSB = Slave no 15
 Register 2003h, MSB = Slave no 16 LSB = Slave no31.
 2 Registers.

Dec	Hex		Hi	Lo			Setup
8208	2010		Hour	Minute	0..23	0..59	Setup
8209	2011		Seconds	Day of week	0..59	0..FF	Setup
8210	2012		Month	Date	1..12	1..31	Setup
8211	2013		Year	Year	0..99	0..99	Setup

Read Generators internal 24 Hour clock.
 Format: hh.mm, ss,dd,MM,DD,YYYY

Day of week: 1 Monday ..7 Sunday.
 The Data format is BCD

Note: All 4 Registers must be read simultaneously.

16384	4000		HI	LO	A1 Limit 1 Low	Setup
16385	4001		HI	LO	A1 Limit 1 High	Setup
16386	4002		HI	LO	A1 Limit 2 Low	Setup
16387	4003		HI	LO	A1 Limit 2 High	Setup
16388	4004		HI	LO	A2 Limit 1 Low	Setup
	4008		HI	LO	A3 Limit 1 Low	Setup
16416	4020		HI	LO	B1 Limit 1 Low	Setup
16892	41FC		HI	Lo	P8 Limit 1 Low	Setup
16893	41FD		HI	Lo	P8 Limit 1 High	Setup
16894	41FE		HI	Lo	P8 Limit 2 Low	Setup
16895	41FF		HI	Lo	P8 Limit 2 High	Setup

Read AnaLink channels Set-Point values, as configured or as set by a previous ModBus write-command.

Legal Values lies in the range from 0 to 255, and must be scaled according to the type of analink signal.

Responds only, if channel is configured for AnaLink channeltype.
4 Registers per Setup.
Reading of 1 to 32 registers possible

If an attempt is made to read from a start-address and the number of registers exceeds the allowed register range, no answer will be made, as this is interpreted as an illegal function

16896	4200		HI	LO	A1 on-delay tb	Setup
16897	4201		HI	LO	A1 on-delay	Setup
16898	4202		HI	LO	A1 off-delay tb	Setup
16899	4203		HI	LO	A1 off Delay	Setup
16900	4204		HI	LO	A2 on-delay tb	Setup
16904	4208		HI	LO	A3 on-delay tb	Setup
16928	4220		HI	LO	B1 on-delay tb	Setup
17404	43FC		HI	Lo	P8 on-delay tb	Setup
17405	43FD		HI	Lo	P8 on-delay	Setup
17406	43FE		HI	Lo	P8 off-delay tb	Setup
17407	43FF		HI	Lo	P8 off delay	Setup

Read timer channels Set-up ON and OFF delays, as configured or as set by a previous ModBus write-command.

the delay-tb, if zero, the delay is counted in seconds. If tb = 1, the delay is counted in minutes.

Responds only, if channel is configured for Timer channel type.
4 Registers per Setup.
Reading of 1 to 128 registers possible

If an attempt is made to read from a start-address and the number of registers exceeds the allowed register range, no answer will be made, as this is interpreted as an illegal function.

24576	6000	A1	HI: hour	Lo: min	On-time1	Setup
24577	6001	A1	hour	Min	Off-time 1	Setup
24578	6002	A1	xxx	Days	Day select 1	Setup
24579	6003	A1	xxx	xxx	Don't-care	Setup
24580	6004	A1	HI: hour	Lo: min	On-time 2	Setup
24581	6005	A1	hour	Min	Off-time 2	Setup
24582	6006	A1	xxx	Days	Day select 2	Setup
24583	6007	A1	xxx	xxx	Don't-care	Setup
24584	6008	A1	HI: hour	Lo: min	On-time3	Setup
24585	6009	A1	hour	Min	Off-time 3	Setup
24586	600A	A1	xxx	Days	Day select 3	Setup
25587	600B	A1	xxx	xxx	Don't-care	Setup
25588	600C	A1	HI: hour	Lo: min	On-time 4	Setup
25589	600D	A1	hour	Min	Off-time 4	Setup
25590	600E	A1	xxx	Days	Day select 4	Setup
25591	600F	A1	xxx	xxx	Don't-care	Setup
25592	6010	B1	HI: hour	Lo: min	On-time 1	Setup
26620	67FC	P8	HI: hour	Lo: min	On-time 4	Setup
26621	67FD	P8	hour	Min	Off-time 4	Setup
26622	67FE	P8	xxx	Days	Day select 4	Setup
26623	67FF	P8	xxx	xxx	Don't-care	Setup

Read Realtime channels Set-up values, as configured or as set by a previous ModBus write-command.

Read On/Off times and day/holiday setup.

Responds only, if channel is configured for a Realtime channeltype.
16 Registers per Setup.
Reading of 1 to 32 registers possible

If an attempt is made to read from a start-address and the number of registers exceeds the allowed register range, no answer will be made, as this is interpreted as an illegal function.

Hour and Minutes in BCD
If Hour -value is read as FFh, then this setting is not active.
Days: MSB: Holiday
LSB: Monday

49408	C100	A1	HI	LO		Pulse count
49409	C101	A2	HI	LO		Pulse count
49410	C102	A3	HI	LO		Pulse count
49411	C103	A4	HI	LO		Pulse count
49534	C17E	P7	HI	LO		Pulse count
49535	C17F	P8	HI	LO		Pulse count

Read Pulse-counter Latched (Frozen) values

If an attempt is made to read from a start-address and the number of registers exceeds the allowed register range, no answer will be made, as this is interpreted as an illegal function.

Countvalue in BCD from 0 to 9999

Reading of 1 to 32 registers possible

Function Code 05: Set single Output Bit

Register Address		Register 8 bit				
Dec	Hex					
5376	1500		A1	00=Off		Bit
5377	1501		A2	01=On		Bit
.	.		.	.		Bit
5503	157F		P8			Bit

Write a bit, for statically activation of a Dupline channel.
This command will start the configured function, on that channel, as if a transmitter on that channel are held activated.

Writing of only 1 register at a time is allowed.
Value : 1 start the function, and keep it activated
Value: 0 Release the function.

12288	3000	0	HI	LO		Bit
12289	3001	1	HI	LO		Bit
12290	3002	2	HI	LO		Bit
12291	3003	3	HI	LO		Bit
		4	Hi	Lo		Bit
						Bit
12414	307E	126	HI	LO		Bit
12415	307F	127	HI	LO		Bit

Write a bit, for momentary activation of a Dupline Channel

This command will start the configured function, on that channel, as if a transmitter on that channel were activated for a short pulse.
Writing of only 1 register at a time is allowed.

Value 1: trigger the function
Value 0: allowed, but has no function.

12544	3100	0	HI	LO		Bit
12545	3101	1	HI	LO		Bit
12546	3102	2	HI	LO		Bit
12547	3103	3	HI	LO		Bit
		4	Hi	Lo		Bit
						Bit
12670	317E	126	HI	LO		Bit
12671	317F	127	HI	LO		Bit

Write a bit, for set or reset of a Dupline Channel

This command will enforce the channel into On or Off , as if a masterfunction were activated on the channels.
Writing of only 1 register at a time is allowed.

Value 1: Set
Value 0: Reset

49152	C000	0	HI	LO		Bit
49153	C001	1	HI	LO		Bit
49154	C002	2	HI	LO		Bit
49155	C003	3	HI	LO		Bit
		4	Hi	Lo		Bit
						Bit
49278	C07E	126	HI	LO		Bit
49279	C07F	127	HI	LO		Bit

Reset Multiplexed counter.

A write of a 1, to any address, will reset the multiplexed counter.
Writing of only 1 register at a time is allowed.
Value : 0 or 1

Function Code 06: Preset Single Register

Register Address		Register 8 bit				Format
Dec	Hex					
4096	1000		B8..B1	A8..A1		Digital
4097	1001		D	C		Digital
.	.		.	.		Digital
4103	1007		P	O		Digital

Write data for Output on Dupline channels.

Writing 1's will start the configured function, on that channel, as if a transmitter were activated on the corresponding channels.

Register Address		Register 8 bit				Format
Dec	Hex					
12288	3000		B8..B1	A8..A1		Digital
12289	3001		D	C		Digital
.	.		.	.		Digital
12295	3007		P	O		Digital

Write data for momentary activation of a Dupline Channel

This command will start the configured function, on that channel, as if a transmitter on that channel were activated for a short pulse.
Writing of only 1 register at a time is allowed.

Bits set, trigger the corresponding channels
Bits clear, has no function.

Function Code 16: Preset Multiple Registers

Dec	Hex		Hi	Lo		
4096	1000		B8-B1	A8-A1		Digital
4097	1001		D	C		Digital
.	.		.	.		Digital
4103	1007		P	O		Digital

Write data for Output on Dupline channels.

Writing 1's will start the configured function, on that channel, as if a transmitter were activated on the corresponding channels.

Writing of 1 to 8 registers possible.

If an attempt is made to write to a start-address and the number of registers exceeds the allowed register range, no answer will be made, as this is interpreted as an illegal function

Dec	Hex		Hi	Lo		
4112	1010		B8-B1	A8-A1		Digital
4113	1011		D	C		Digital
.	.		.	.		Digital
4119	1017		P	O		Digital

Write data for Forcing the Output on Dupline channels.

Writing 1's will force the channels on, as if a masterfunction activated the corresponding channels.

Writing of 1 to 8 registers possible.

If an attempt is made to write to a start-address and the number of registers exceeds the allowed register range, no answer will be made, as this is interpreted as an illegal function

4880	1310	0	HI	LO	CD-0	Output Table
4881	1311	1	HI	LO	CD-1	Output Table
4882	1312	2	HI	LO	CD-2	Output Table
4883	1313	3	HI	LO	CD-3	Output Table
.	Output Table
4895	131F	F	HI	LO	CD-F	Output Table
4896	1320	0	HI	LO	EF-0	Output Table
4911	132F	F	HI	LO	EF-F	Output Table
4912	1330	0	HI	LO	GH-0	Output Table
4929	133F	F	HI	LO	GH-F	Output Table
4930	1340	0	HI	LO	IJ-0	Output Table
4943	134F	F	HI	LO	IJ-F	Output Table
4944	1350	0	HI	LO	KL-0	Output Table
4959	135F	F	HI	LO	KL-F	Output Table
4960	1360	0	HI	LO	MN-0	Output Table
4975	136F	F	HI	LO	MN-F	Output Table
4976	1370	0	HI	LO	OP-0	Output Table
4990	137F	F	HI	LO	OP-15	Output Table
						Output Table

Multiplexed Analog Write Output Table (AO)

Registers 1300H to 137FH BCD-VALUES
Registers 1400H to 147FH BINARY-VALUES

Multiplexed analog values only valid if Multiplexer is selected
Writing of 1 to 32 registers possible

Dec	Hex		Hi	Lo			
8192	2000		Hour	Minute	0..23	0..59	Setup
8193	2001		Seconds	Day of week	0..59	0..FF	Setup
8194	2002		Month	Date	1..12	1..31	Setup
8195	2003		Year	Year	0..99	0..99	Setup

Set Generators internal 24 Hour clock.
Format: hh.mm, ss,dd,MM,DD,YYYY

Day of week: 1 Monday ..7 Sunday.
The Data format is BCD and should hold a valid date and time.
If format is wrong, the command is not responded to.

Note: All 4 Registers must be written simultaneously.

16384	4000		HI	LO	A1 Limit 1 Low	Setup
16385	4001		HI	LO	A1 Limit 1 High	Setup
16386	4002		HI	LO	A1 Limit 2 Low	Setup
16387	4003		HI	LO	A1 Limit 2 High	Setup
16388	4004		HI	LO	A2 Limit 1 Low	Setup
	4008		HI	LO	A3 Limit 1 Low	Setup
16416	4020		HI	LO	B1 Limit 1 Low	Setup
16892	41FC		HI	Lo	P8 Limit 1 Low	Setup
16893	41FD		HI	Lo	P8 Limit 1 High	Setup
16894	41FE		HI	Lo	P8 Limit 2 Low	Setup
16895	41FF		HI	Lo	P8 Limit 2 High	Setup

Write AnaLink channels Set-Point values.

Legal Values lies in the range from 0 to 255, and must be scaled according to the type of analink signal.

Responds only, if channel is configured for a Realtime channeltype.
4 Registers per Setup.
Writing of 1 to 32 registers possible

If an attempt is made to read from a start-address and the number of registers exceeds the allowed register range, no answer will be made, as this is interpreted as an illegal function.

The changes are stored permanently in the system configuration memory.

16896	4200		HI	LO	A1 on-delay tb	Setup
16897	4201		HI	LO	A1 on-delay	Setup
16898	4202		HI	LO	A1 off-delay tb	Setup
16899	4203		HI	LO	A1 off Delay	Setup
16900	4204		HI	LO	A2 on-delay tb	Setup
16904	4208		HI	LO	A3 on-delay tb	Setup
16928	4220		HI	LO	B1 on-delay tb	Setup
17404	43FC		HI	Lo	P8 on-delay tb	Setup
17405	43FD		HI	Lo	P8 on-delay	Setup
17406	43FE		HI	Lo	P8 off-delay tb	Setup
17407	43FF		HI	Lo	P8 off delay	Setup

Write timer channels configuration for ON and OFF delays

Delays < 12. hours counts in seconds and delay-tb are set to 0
Dalays >12 hours counts in Minutes and delay-tb are set to 1

Responds only, if channel is configured for Timer channel type.
4 Registers per Setup.
Reading of 1 to 128 registers possible

If an attempt is made to read from a start-address and the number of registers exceeds the allowed register range, no answer will be made, as this is interpreted as an illegal function.

The changes are stored permanently in the system configuration memory.

Mastergenerator ModBus Functions

24576	6000	A1	Hl: hour	Lo: min	On-time1	Setup
24577	6001	A1	hour	Min	Off-time 1	Setup
24578	6002	A1	xxx	Days	Day select 1	Setup
24579	6003	A1	xxx	xxx	Don't-care	Setup
24580	6004	A1	Hl: hour	Lo: min	On-time 2	Setup
24581	6005	A1	hour	Min	Off-time 2	Setup
24582	6006	A1	xxx	Days	Day select 2	Setup
24583	6007	A1	xxx	xxx	Don't-care	Setup
24584	6008	A1	Hl: hour	Lo: min	On-time3	Setup
24585	6009	A1	hour	Min	Off-time 3	Setup
24586	600A	A1	xxx	Days	Day select 3	Setup
25587	600B	A1	xxx	xxx	Don't-care	Setup
25588	600C	A1	Hl: hour	Lo: min	On-time 4	Setup
25589	600D	A1	hour	Min	Off-time 4	Setup
25590	600E	A1	xxx	Days	Day select 4	Setup
25591	600F	A1	xxx	xxx	Don't-care	Setup
25592	6010	B1	Hl: hour	Lo: min	On-time 1	Setup
26620	67FC	P8	Hl: hour	Lo: min	On-time 4	Setup
26621	67FD	P8	hour	Min	Off-time 4	Setup
26622	67FE	P8	xxx	Days	Day select 4	Setup
26623	67FF	P8	xxx	xxx	Don't-care	Setup

Write Realtime channels Set-up values

Write On/Off times and day/holiday setup.

Hour and Minutes in BCD

To disable an on or off setting , write 0FFh to the Hour-byte

Days: MSB: Holiday
LSB: Monday

Responds only, if channel is configured for a Realtime channeltype.

16 Registers per Setup.
Writing of 1 to 32 registers possible

If an attempt is made to read from a start-address and the number of registers exceeds the allowed register range, no answer will be made, as this is interpreted as an illegal function.

The changes are stored permanently in the system configuration memory.

Dec	Hex		Hi	Lo		Pulse Count
8192	A00 0		AAh	55h		Reset
8193	A00 1		AAh	55h		Freeze

Reset and Freeze command, for Pulse-counters

The reset command, clears all pulse-counters.

The Freeze command, latches the actual counter-values , so they may be read by the FC 03 address C100h.

Only when value is AA55h, the commands are executed.

1 Register only.

Appendix C

RS485 Communications

The cable

RS485 communication cable is a shielded, twisted pair cable. Many cable manufacturers supply cable meeting the RS485 standard (e.g. Belden 9841). Other cabling media such as telephone cable, coaxial cable and multi-core wires could prove problematic and not provide satisfactory performance.

Topology

The cable must be installed to pass close by each node. Stubs (cables joining the node to the cable) or stars (multiple cable segments brought back to a single point) are not permitted.

Cable Length

The maximum length of a single cable run is 1200 meters.

Connection of the cable shield

The shield of the RS485 cable establishes a reference voltage for the RS485 signal conductors. For this reason the cable shield must be connected to V- (terminal 32) on each Master Generator on the network. The "screen pig-tails" going into the terminals should be as short as possible. The shield should be continuous throughout the installation, but only connected to proper ground at one point with an earth contact resistance of less than 2 Ω.

Termination and Fail-safe resistors

The cable must be terminated at each end. This is to prevent reflections which would disrupt communications. Also, the use of so-called fail-safe pull-up and pull-down resistors in one of the ends is required to ensure safe and reliable communication. The Master Generator has built-in termination and fail-safe resistors. The termination resistor is connected to terminal 30 (B) and terminal 27 internally. Therefore pin 27 needs to be connected to pin 31 (A) in both of the cable endings in order to make the terminations effective. The fail-safe resistors shall only be used in one cable end. By connecting pin 31 (A) to pin 29, and by connecting pin 30 (B) to pin 28 the fail-safe resistors are made effective.

Cable Isolation

The communication cable must not be run in cable trays carrying power wiring nor in close proximity to power wiring. Current surges in power wiring due to high equipment starting currents or to faults can disrupt communications.

Wiring diagram

Find below an example of a complete wiring diagram for a system with 3 Master Generators connected in an RS485 network.

