

Photoelectrics Retro-reflective Type PD30CNR60....SA

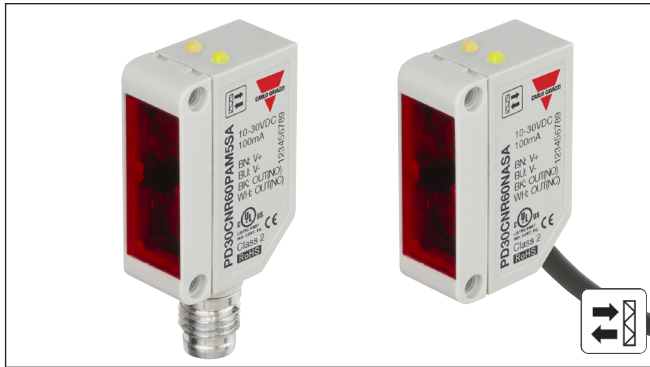

- Miniature sensor range
- Range: 6 m
- Sensitivity adjustment by Potentiometer
- Modulated, infrared light 850 nm
- Supply voltage: 10 to 30 VDC
- Output: 100 mA, NPN or PNP preset
- Make and break switching function
- LED indication for output, stability and power ON
- Protection: reverse polarity, short circuit and transients
- Cable and plug versions
- Excellent EMC performance



Product Description

The PD30CNR60 sensor family comes in a compact 10 x 30 x 20 mm reinforced PMMA/ABS housing. The sensors are useful in applications where high-accuracy detection as well as small size is required. Compact housing and high power LED for excellent performance-size ratio.

The Potentiometer function for adjustment of the sensitivity makes the sensors highly flexible. The output type is preset (NPN or PNP), and the output switching function is NO and NC output.

Ordering Key

PD30CNR60NAM5SA

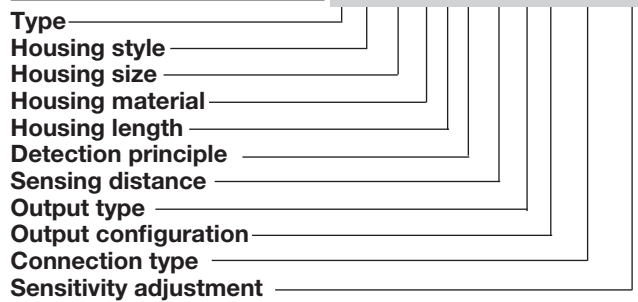

Type Selection

Housing W x H x D	Range S _n	Connection	Ordering no. NPN Make and break switching	Ordering no. PNP Make and break switching
10 x 30 x 20 mm	6 m	Cable	PD 30 CNR 60 NASA	PD 30 CNR 60 PASA
10 x 30 x 20 mm	6 m	Plug	PD 30 CNR 60 NAM5SA	PD 30 CNR 60 PAM5SA

Specifications EN 60947-5-2

Rated operating distance (S_n) Ø 80 mm (ER4) reflector ER4060 reflector	≤ 6 m ≤ 4 m	Protection	Short-circuit, reverse polarity and transients
Blind zone	≤ 100 mm @ Ø80 mm (ER4) and ER4060 reflector	Light source	LED, 850 nm
Sensitivity Electrical adjustment Mechanical adjustment	210° 240°	Light type	Infrared, modulated
Temperature drift	≤ 0.2%/°C	Emitter angle	± 2° @ half sensing distance
Hysteresis (H)	5% to 20%	Light spot	110 mm @ 1.5 meters
Rated operational volt. (U_B)	10 to 30 VDC (ripple included)	Ambient light	≤ 10,000 lux
Ripple (U_{rpp})	≤ 10%	Operating frequency (f)	≤ 1000 Hz
Output current Continuous (I _a) Short-time (I)	≤ 100 mA ≤ 100 mA (max. load capacity 100 nF)	Response time OFF-ON (t _{ON}) ON-OFF (t _{OFF})	≤ 0.5 ms ≤ 0.5 ms
No load supply current (I_o)	≤ 20 mA @ U _B max	Power ON delay (t_v)	≤ 30 ms
Minimum operational current (I_m)	≤ 0.5 mA	Output function Open collector	NPN or PNP by sensor type
OFF-state current (I_r)	≤ 100 µA	Output switching function	N.O. and N.C.
Voltage drop (U_d)	≤ 2 VDC @ I _a max	Indication Output ON Power ON	LED, yellow Signal stability ON and LED, green. See curve for condition of stability



Specifications (cont.)

Environment		Housing material	
Installation category	III (IEC 60664/60664A; 60947-1)	Body	ABS Light Grey
Pollution degree	3 (IEC 60664/60664A; 60947-1)	Frontglas	PMMA Red
Degree of protection	IP 67 (IEC 60529; 60947-1)	Trimmer shaft	POM Dark Grey
Ambient temperature		Connection	
Operating	-25° to +60°C (-13° to +140°F)	Cable	PVC, black, 2 m 4 x 0.14 mm ² , Ø = 3.3 mm
Storage	-40° to +70°C (-40° to +158°F)	Plug	M8, 4-pin (CON.54NF.. series)
Vibration		Weight	
10 to 150 Hz, 1.0 mm/15 G (IEC 60068-2-6)		Cable version	≤ 50 g
Shock		Plug version	≤ 20 g
30 g / 11ms, 3 pos, 3 neg per axis (IEC 60068-2-6, 60068-2-32)		CE-marking	
Rated insulation voltage		Yes	
≤ 500 VAC (rms)*		Approvals	
		cULus (UL508 + CSA)	

Operation Diagram

Tv = Power ON delay

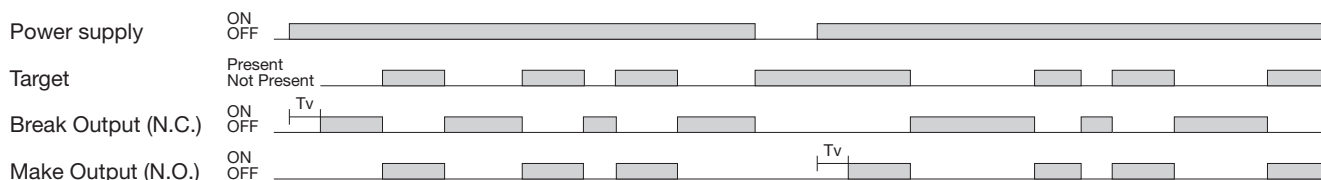

Signal Stability Indication

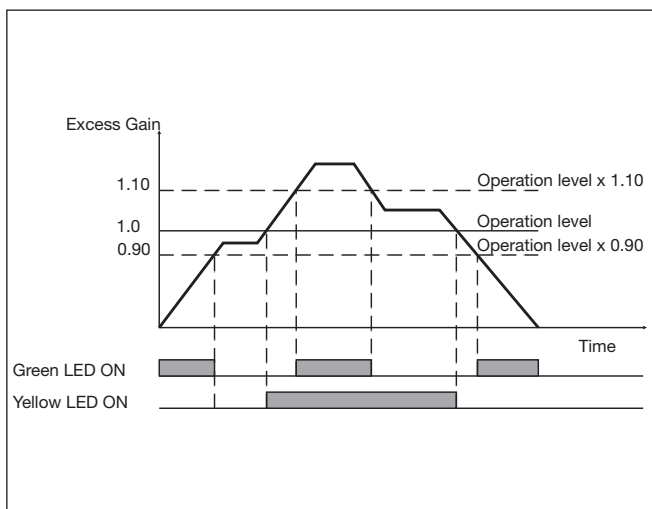

Wiring Diagrams

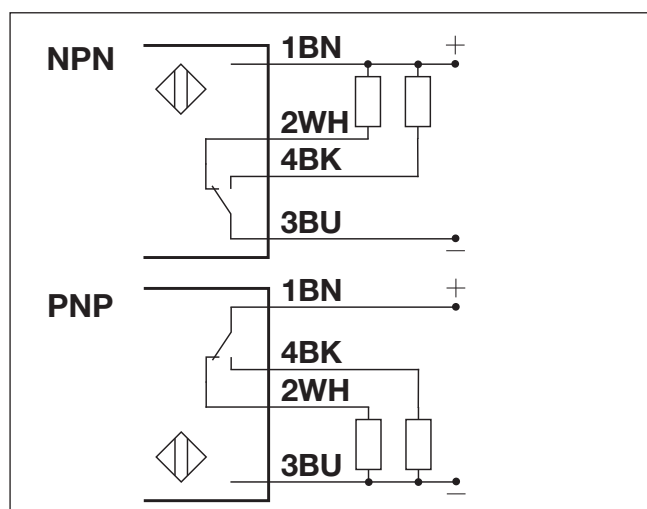

Detection Diagram

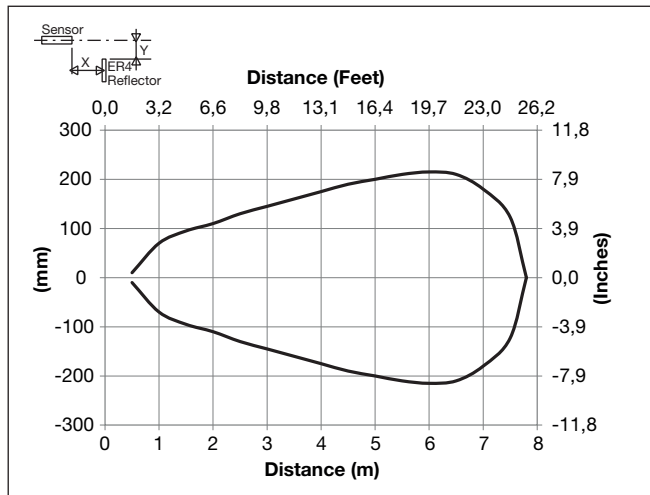

Excess Gain

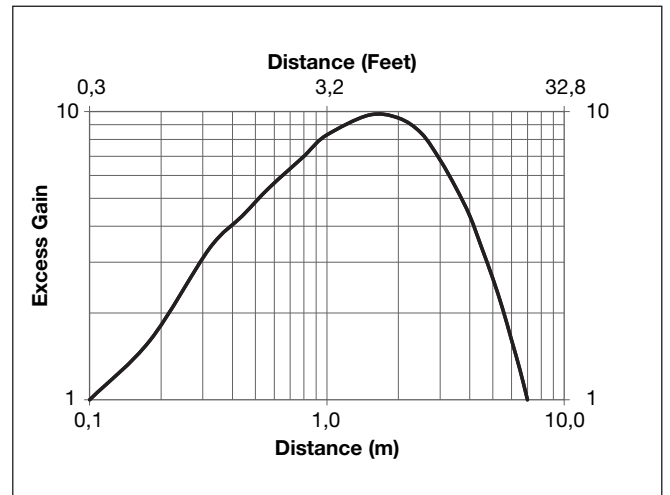

Dimensions

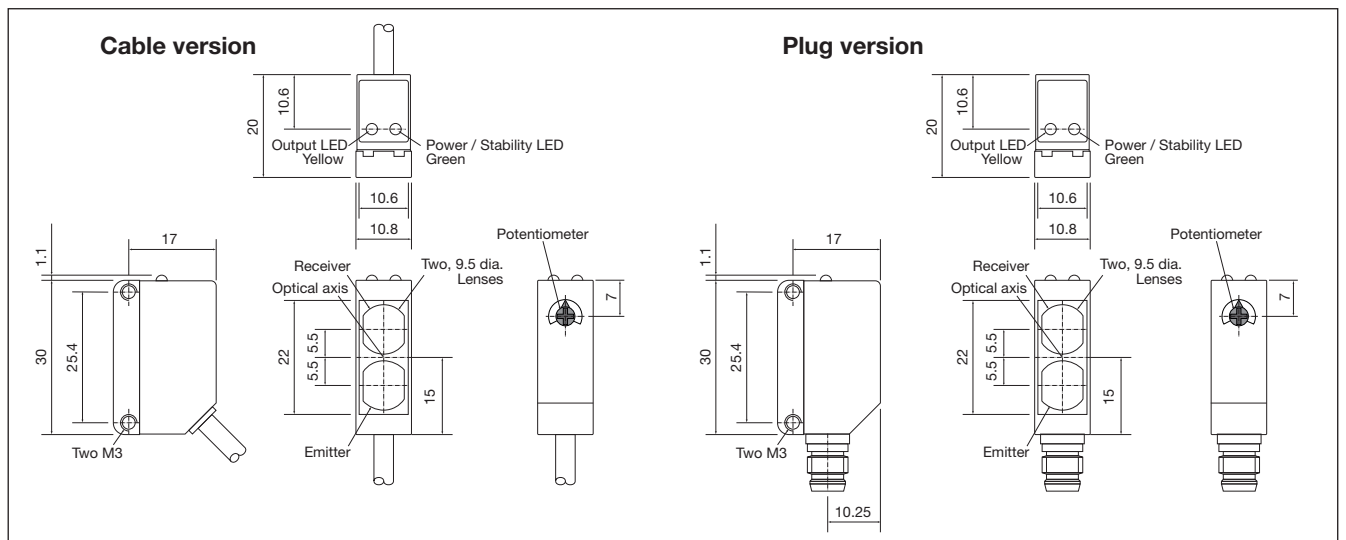

Installation Hints

<p>To avoid interference from inductive voltage / current peaks, separate the proximity switch cables from any other power cables. E.g. Engine, contactor or solenoid cables</p> <p>Incorrect: Cables bundled together. Correct: Cables separated by > 100 mm.</p>	<p>Relief of the cable strain</p> <p>Incorrect: Cable pulled. Correct: Cable looped back.</p> <p>The cable should not be pulled</p>	<p>Protection of the sensing face</p> <p>Incorrect: Cable bent against sensing face. Correct: Cable bent away from sensing face.</p> <p>A proximity switch should not serve as mechanical stop</p>	<p>Sensor mounted on a mobile carrier</p> <p>Correct: Sensor mounted on a carrier with a loop. Incorrect: Cable repeatedly flexed.</p> <p>Any repetitive flexing of the cable should be avoided</p>
---	---	--	---

Accessories

- Mounting bracket APD30-MB1 or APD30-MB2 to be purchased separately.

Delivery Contents

- Photoelectric switch: PD30CNR60 ...
- Screwdriver
- Packaging: Plastic bag