

Proximity Sensors Capacitive Flat Pack Polycarbonate Housing Type EC 5525, DC

TRIPLESHIELD™

CARLO GAVAZZI

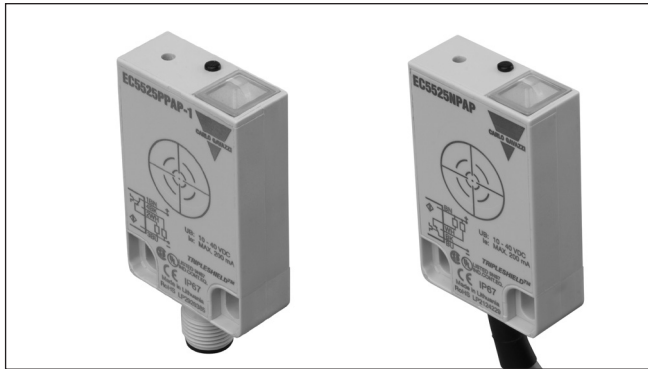

- Featuring **TRIPLESHIELD™** sensor protection
- Adjustable sensing distance 4-25 mm
- Rated operational voltage: 10-40 VDC
- Output: DC 200 mA, NPN or PNP
- Make and break switching function, LED indication
- Capacitive, Inductive and Photoelectric flat pack series in PC housing, IP 67
- High noise immunity
- Universal flush and non-flush mountable
- Plug and cable versions

Product Description

Capacitive proximity switches with sensing distance 16 mm flush mounted and sensing distance 25 mm non-flush mounted by adjustment. 4-wire DC output with both make (NO) and break (NC)

switching. Flat pack housing, size (WxHxD) 35 x 55 x 15 mm made in polycarbonate. Easy mounting with only two M4 screws. Ideal for use in material handling and plastic machinery applications.

Ordering Key

EC 55 25 NPA P-1

Capacitive proximity switch
Housing
Rated operational distance
Output type
Housing material
Connection type

Type Selection

Housing dimensions W x H x D	Rated operating dist. (S _n) ¹⁾ Flush/non-flush	Ordering no. NPN/cable Make & break swit.	Ordering no. NPN/plug Make & break swit.	Ordering no. PNP/cable Make & break swit.	Ordering no. PNP/plug Make & break swit.
35 x 55 x 15	16/25 mm	EC 5525 NPAP	EC 5525 NPAP-1	EC 5525 PPAP	EC 5525 PPAP-1

¹⁾ Object: Grounded steel plate

Specifications

Rated operating dist. (S_n)	4 to 25 mm factory set at 25 mm	Frequency of operating cycles (f)	50 Hz
Sensitivity	Adj. 270° single turn pot.meter	Indication for output ON	LED, yellow
Effective operating dist. (S_r)	0.9 x S _n ≤ S _r ≤ 1.1 x S _n	Environment	Degree of protection
Usable operating dist. (S_u)	0.8 x S _r ≤ S _u < 1.2 x S _r		IP 67 (Nema 1, 3, 4, 6, 13)
Repeat accuracy (R)	≤ 5%	Temperature	Operating temperature
Hysteresis (H)	3 to 20% of sensing distance		-25 to +80°C (-13 to +176°F)
Rated operational volt. (U_B)	10 to 40 VDC (ripple incl.)		Storage temperature
Ripple	≤ 10%	Housing material	Polycarbonate (PC), grey
Rated operational current (I_e)		Connection	
Continuous	≤ 200 mA	Cable	Grey, 2 m, 4 x 0.34 mm ² Oil proof, PVC
No-load supply current (I_o)	≤ 10 mA (no load)	Plug (-1)	M12 x 1
Voltage drop (U_d)	≤ 2.5 VDC at max. load	Cable for plug (-1)	CON.14NF.. series
Protection	Reverse polarity, short-circuit, transients	Weight (incl. nuts)	125 g (cable version) 40 g (plug version)
		Approvals	UL, CSA
		CE-marking	Yes

Dimensions

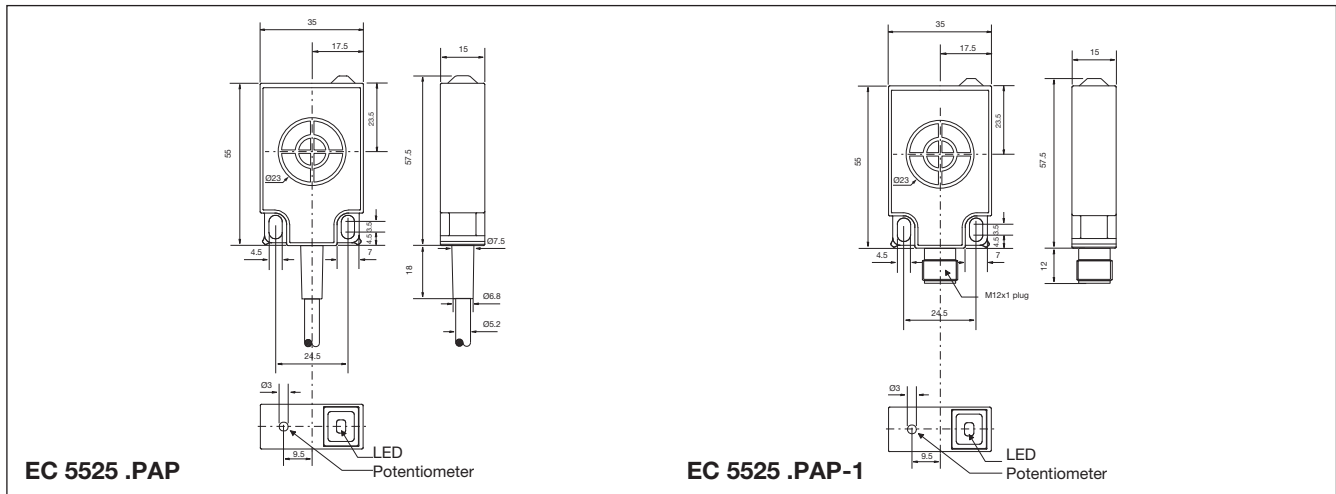

Wiring Diagrams

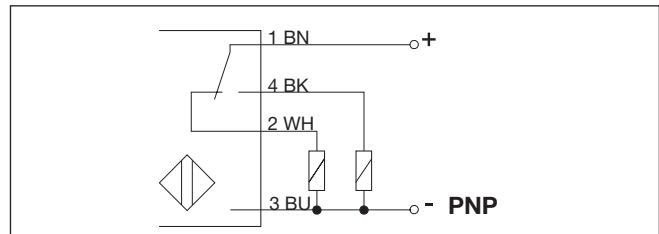
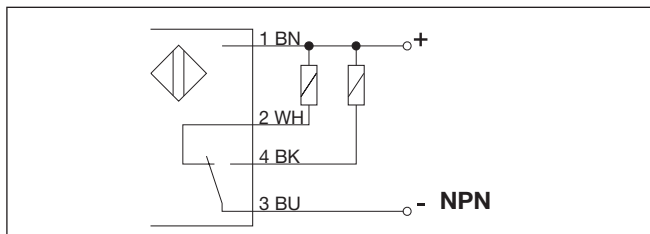

Adjustment Guide

The environments in which capacitive sensors are installed can often be unstable regarding temperature, humidity, object distance and industrial (noise) interference. Because of this, Carlo Gavazzi offers as standard features in all *TRIPLESIELD™* capacitive sensors a user-friendly sensitivity adjustment instead of having a fixed sensing range, extended

sensing range to accommodate mechanically demanding areas, temperature stability to ensure minimum need for adjusting sensitivity if temperature varies and high immunity to electro-magnetic interference (EMI).

Note:
Sensors are factory set (default) to maximum rated sensing range.

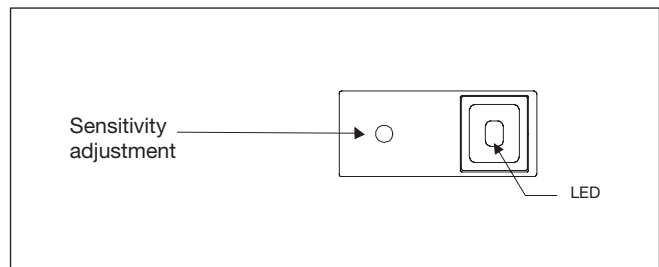

Installation Hints

Capacitive sensors have the unique ability to detect almost all materials, either in liquid or solid form. Capacitive sensors can detect metallic as well as non-metallic objects, however, their traditional use is for non-metallic materials such as:

- **Plastic Industry**
Resins, regrinds or moulded products.
- **Chemical Industry**
Cleansers, fertilisers, liquid soaps, corrosives and petrochemicals.
- **Wood Industry**
Saw dust, paper products, door and window frames.
- **Ceramic & Glass Industry**
Raw material, clay or finished products, bottles.

- **Packaging Industry**
Packaging inspection for level or contents, dry goods, fruits and vegetables, dairy products.
- Materials are detected due to their dielectric constant. The bigger the size of an object, the higher the density of material, the better or easier it is to detect the object. Nominal sensing distance

for a capacitive sensor is referenced to a grounded metal plate (ST37). For additional information regarding dielectric ratings of materials please refer to Technical Information.

Installation Hints (cont.)

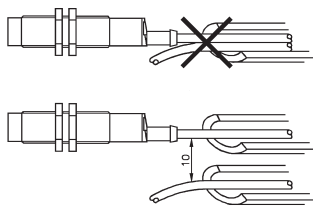
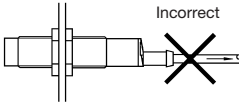
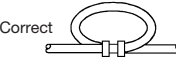
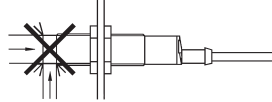
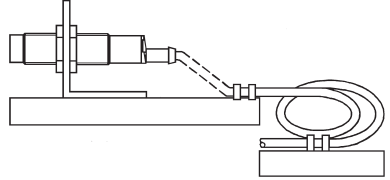
<p>To avoid interference from inductive voltage/ current peaks, separate the prox. switch power cables from any other power cables, e.g. motor, contactor or solenoid cables</p> 	<p>Relief of cable strain</p> <p>Incorrect</p>  <p>Correct</p>  <p>The cable should not be pulled</p>	<p>Protection of the sensing face</p>  <p>A proximity switch should not serve as mechanical stop</p>	<p>Switch mounted on mobile carrier</p>  <p>Any repetitive flexing of the cable should be avoided</p>
--	---	--	--

Delivery Contents

- Capacitive switch: EC55.. PAP(-1)
- Screw driver
- **Packaging:** Cardboard box
- Installation & Adjustment Guide

Accessories

- Plugs CON.14NF.. series